



## Four Enhanced Science Learning Dimensions

**Document Version:**

Publisher's PDF, also known as Version of record

**Citation for published version:**

Langley, D, Arieli, R & Eylon, BS 2010, Four Enhanced Science Learning Dimensions: The Physics & Industry Programme. in *Teaching and Learning Physics today: Challenges? Benefits?*. pp. 657-668, GIREP-ICPE-MPTL 2010, Reims, France, 22/8/10.

*Total number of authors:*

3

**Published In:**

Teaching and Learning Physics today: Challenges? Benefits?

**License:**

Other

**General rights**

@ 2020 This manuscript version is made available under the above license via The Weizmann Institute of Science Open Access Collection is retained by the author(s) and / or other copyright owners and it is a condition of accessing these publications that users recognize and abide by the legal requirements associated with these rights.

**How does open access to this work benefit you?**

Let us know @ [library@weizmann.ac.il](mailto:library@weizmann.ac.il)

**Take down policy**

The Weizmann Institute of Science has made every reasonable effort to ensure that Weizmann Institute of Science content complies with copyright restrictions. If you believe that the public display of this file breaches copyright please contact [library@weizmann.ac.il](mailto:library@weizmann.ac.il) providing details, and we will remove access to the work immediately and investigate your claim.



MPTL

Multimedia in Physics Teaching and Learning



UNIVERSITÀ  
DEGLI STUDI  
DI UDINE

Proceedings of selected papers of the  
GIREP - ICPE-MPTL  
International conference

# Teaching and Learning Physics today: Challenges? Benefits?

Reims, August 22-27, 2010, France

Editors

Wanda Kaminski, Marisa Michelini

During the last 15 years, in most countries, the popularity of physics among students has been low and the enrolment has declined. Different approaches have been proposed to confront this situation, both at school and university levels. It seems that some of them have been successful. We hope that our conference will offer an opportunity for in-depth discussions of this topic and for sharing our experiences in order to move forward in this field.

*Cooperating institutions:*







**MPTL**

Multimedia in Physics Teaching and Learning



**UNIVERSITÀ  
DEGLI STUDI  
DI UDINE**

## **TEACHING AND LEARNING PHYSICS TODAY: CHALLENGES? BENEFITS?**

Proceedings of selected papers of the GIREP-ICPE-MPTL International Conference

Reims, August 22-27, 2010

### **Editors**

Wanda Kaminski and Marisa Michelini

### **Editorial board**

Constantinos P. Constantinou, *University of Cyprus*

Michele D'Anna, *Alta Scuola Padagogica, Switzerland*

Leos Dvorak, *Prague University, Czeck Republic*

Ton Ellermeijer, *University of Amsterdam, The Netherlands*

Claudia Haagen-Schuetzenhoefer, *Wien University, Austria*

Pratibha Jolly, *University of Delhi, India*

Ian Laurence, *University of Birmingham, UK*

Leopold Mathelitsch, *University of Graz, Austria*

Marisa Michelini, *Università di Udine, Italy*

Cesar Eduardo Mora, *Instituto Politecnico Nacional, Mexico*

Wim Peeters, *Pedagogical advisor for PBDKO*

Gorazd Planinsic, *University of Ljubljana, Slovenia*

Rosa Maria Sperandeo-Mineo, *Università di Palermo, Italy*

Robert Sporken, *FUNDP Namur, Belgium*

Laurence Viennot, *University Denis Diderot Paris 7, France*

Dean Zollman, *Kansas State University, USA*

Jean-Stephane Antoniow, Vincent Barbin, Jean-Luc Bodnar, Manuel Dauchez, Wanda Kaminski,

Gerard Mary, *Universite de Reims Champagne Ardenne, France*

Philippe Colin, Cecile de Hosson, Martine Meheut, *Universite Paris Diderot Paris 7, France* Valerie Munier, *Montpellier II, France*

### **Layout**

Salemi Giorgio, *University of Udine, Italy*

Cooperating institutions:



© Copyright Università degli Studi di Udine

Finito di stampare nel mese di giugno 2014 LithoStampa - Pasion di Prato (Udine) ISBN 978-88-97311-32-4



**MPTL**  
Multimedia in Physics Teaching and Learning



**UNIVERSITÀ  
DEGLI STUDI  
DI UDINE**

Proceedings of selected papers of the  
GIREP - ICPE-MPTL  
International conference

# Teaching and Learning Physics today: Challenges? Benefits?

Reims, August 22-27, 2010, France

Editors

Wanda Kaminski, Marisa Michelini

*Cooperating institutions:*



# Contents

Chapter 1 - Background aspects	1
1.1 - The International Commission on Physics Education: Challenges and Opportunities, Pratibha Jollya	2
1.2 - Mechanics Multimedia Reviews -Ludwig Maximilians, Bruce Mason	20
1.3 - Stimulating scientific reasoning through explorations of simple experiments - Gorazd Planinsic	34
1.4 - The many challenges of Inquiry Based Science Education:Toward multiple learning benefits? - Laurence Viennot	43
1.5 - Helping our students learn physics and think like scientists - Eugenia Etkina, Anna Karelina, Maria Ruibal Villasenor, Rebecca Jordan, Cindy Hmelo	62
Chapter 2 - Special aspects	87
2.1 – Addressing the role of mathematics in physics education	88
2.1.1 - Addressing the role of mathematics in physics educationOrganizer: Gesche Pospiech	89
2.1.2 - Mathematics in physics: Upper secondary physics students competency to describe phenomena applying mathematical and graphical representations - Øystein Guttersrud, Carl Angell	95
2.1.3 - Translating between mathematics and physics: Analysis of student’s difficulties Olaf Uhdenola, Gesche Pospiech	102
2.1.4 - Utilising technology to develop a collaborative approach to the teachingand learning of physics and mathematics in second level education inIreland - Maire Ni Riordain, Jennifer Johnston, George McClelland, John O Donoghue	107
2.1.5 - Students’ Use Of Mathematical Representations: Solving Problems In Kinematics - Silvia M. Pérez, Celia Dibar	115
2.1.6 - Mathematics in physics lessons: developing structural skills - Ricardo Karam, Gesche Pospiech, Mauricio Pietrocola	121
2.1.7 - Building quantum formalism in upper secondary school students Marisa Michelini, Lorenzo Santi, Alberto, Stefanel	127
2.1.8 - Mathematics as a resource in understanding the peculiar characteristics of magnetic field Carlo Cecchini, Marisa Michelini, Lorenzo Santi, Stefano Vercellati	132
2.1.9 - The interplay of physics and mathematics in a graduatequantum mechanics course for physics teachers - Bat-Sheva Eylonb, Elisheva Cohen, Esther Bagno	138
2.2 – Analogies : a key to understanding physics	145
2.2.1 - IntroductionF riedrich Herrmann	146
2.2.2 - Teaching physics with substance-like quantities - Wu Guobin	147
2.2.3 - Analogy of energy transports - Michael Pohlig	150
2.2.4 - Origin of Analogical Reasoning in Physics - Hans U. Fuchs	151
2.2.5 - Experiments - Michele D’Anna, Joel Rosenberg	158
2.3 – Challenges in primary and secondary science teachers educationtraining	164

2.3.1 - Challenges in Primary and Secondary Science Teachers Education and Training Coordinators - Marisa Michelini, Rosa Maria Sperandeo-Mineo . . . . .	164
2.3.2 - Prospective primary teachers and physics Pedagogical Content Knowledge's - Marisa Michelini, Alberto Stefanel . . . . .	171
2.3.3 - Problems in teaching physics in primary and secondary school, as seen by young Polish she-teachers - Magdalena Sadowska, Anna Kaminska . . . . .	180
2.3.4 - Building a PCK Proposal for Primary Teacher Education in Electrostatics - Marisa Michelini, Alessandra Mossenta . . . . .	186
2.3.5 - Physics Learning Tasks for Students with Special Educational Needs: Disabled and Gifted - Josef Trna, Eva Trnova, Lucie Makydova . . . . .	196
<b>Chapter 3 - Topical Aspects . . . . .</b>	<b>203</b>
<b>3.1 - History and Nature of Science . . . . .</b>	<b>204</b>
3.1.1 - Cultural content knowledge –the required enhancement for physics teachers - Igal Galili . . . . .	205
3.1.2 - Teaching physical concepts using the history of physics - Ivan S. Ruddock . . . . .	213
3.1.3 - Approching the concept of atmospheric pressure :an interview based on Torricelli's barometer. -Pascal Sauvage, Cécile de Hosson . . . . .	219
3.1.4 - The History of Physics as Part of the History of Culture - Dorothy Sebestyen, Obuda University . . . . .	225
3.1.5 - A study on criteria used by students to infer the physical reality of objects: building categories of analysis - Fábio Marineli, Maurício Pietrocola . . . . .	231
<b>3.2 – University teaching/learning proposal . . . . .</b>	<b>237</b>
3.2.1 - Applying the contents of thermodynamics in a multi-phased process in university – What is the problem? - Risto Leinonen, Mervi A. Asikainen, Pekka E. Hirvonen . . . . .	238
3.2.2 - Learning Physics: a Competency-based Curriculum using Modelling Techniques and PBL Approach - Bernard Blandin . . . . .	246
3.2.3 - A Hybrid-Online Course in Introductory Physics - Homeyra R. Sadaghiani . . . . .	255
3.2.4 - A Student-Centered Active Learning Environment for Introductory Physics - Gerald Feldman, Larry Medsker . . . . .	262
3.2.5 - Four Developmental Stages for Cultivation of Interdisciplinary Scientists and Engineers I - Kazuhiko Misawa, Hiroyuki Shimada, Masahiko Shoji, Hiroki Minoda, Kazuyuki Muroo, Osamu Nitoh, and Osamu Sano . . . . .	273
3.2.6 - Four Developmental Stages for Cultivation of Interdisciplinary Scientists and Engineers II - Kazuhiko Misawa, Hiroyuki Shimada, Masahiko Shoji, Hiroki Minoda, Yukari Kato, Kazuyuki Muroo, Osamu Nitoh, Osamu Sano . . . . .	283
3.2.7 - Mental representation in relative velocities - Bastián Montoya Gustavo, Rodríguez Soria Abelardo, Suárez Rodríguez C. Pilar. . . . .	288
3.2.8 - The Concept of Electromotive Force in the Context of Direct-Current Circuits. Students' Difficulties and Guidelines for Teaching - Jenaro Guisasaola, Isabel Garzón, Mieke De Cock . . . . .	293
3.2.9 - Streamlining a sensor technology course in cadets' physics education by pre-evaluation - A.J. Rissanen . . . . .	304

3.3 – Modern and contemporary physics .....	310
3.3.1 - School Inquiries Based on Soft Elastomer Lithography - Anssi Lindell, Anna-Leena Latvala, Jouni Viiri .....	311
3.3.2 - Beliefs of Preservice Teachers regarding the Implementation of Topics of Modern and Contemporary Physics (MCP) in High School - Marcelo Alves Barros, Roser Pintó, Edson Cesar Marques Filho .....	318
3.3.3 - A Nanoscience Course for Upper Secondary Students - Anna Leena Latvala, Anssi Lindell, Tom Nevanpää and Jouni Viiri .....	325
3.3.4 - Teaching the Postulates of Quantum Mechanics in High School: A Conceptual Approach Based on the Use of a Virtual Mach-Zehnder Interferometer - Alexandro Pereira de Pereira, Cláudio José de Holanda Cavalcanti, Fernanda Ostermann .....	335
3.3.5 - Intuitive approach to defects in liquid crystals - T. Kranjc .....	341
3.3.6 - Contemporary physics: challenges and bets for teaching and communicating science. - Eugenio Bertozzi, Elisa Ercolessi, Olivia Levrini .....	348
3.4 – Experiment proposals .....	354
3.4.1 - Simple quantitative electrostatic experiments for teachers and students - Leos Dvorak .....	355
3.4.2 - Physical properties of prism foil and its pedagogical applications - Mihael Gojkosek, Gorazd Planinsic .....	362
3.4.3 - Eurodiffusion – how the physicist study the society - Mojca Cepic, Katarina Susman .....	371
3.4.5 - “Magnetic damping”: Quantitative experiments with MBL sensors - Pasquale Onorato, Anna De Ambrosis .....	387
3.4.6 - Two simple ways of verification of the $1/r^2$ dependence in Coulomb’s law at both high school and university level - Zdenek Sabatka, Leos Dvorak .....	396
3.4.7 - Experiments in Schools and Science Labs An Explicit “Nature of Science”-Aspect in a Project for a Science Lab for School Students - Stefan Uhlmann, Burkhard Priemer .....	402
3.4.8 - Motivational Effectiveness of Experiments in Physics Education - Josef Trna, Petr Novak .....	409
3.4.9 - LEDs in Water: Hands-on Electric Field Lines and Electric Potential Leos Dvorak, Gorazd Planinsic .....	418
3.4.10 - Why Does an Electric Toy Car Move Uniformly? - Lea Valentina Lavrik, Vladimir Meir Shunyakov .....	426
3.4.10 - Shadows Nada Razpet .....	433
3.4.11 - Electromagnetism - seeing and calculating - Krzysztof Rochowicz, Andrzej Karbowski, Krzysztof S uzewski, Grzegorz Karwasz .....	442
3.4.12 - Development of Representational Competence via Cognitively Activating Tasks for Physics Experiments - Jochen Scheid, Andreas Müller, Wolfgang Schnotz, Rosa Hettmannsperger, Jochen Kuhn, Sibel Telli, Patrik Vogt .....	445
3.4.13 - Foucault dissipation of a magnet falling through a copper pipe studied by means of a PC audio card and webcam - Assunta Bonanno, Giacomo Bozzo, Michele Camarca, Marisa Michelini, Peppino Sapia .....	451
3.5 – New teaching/learning methods and inquiry based learning .....	461

3.5.1 - Wave Aspects of Optical Phenomena in the Atmosphere in the Teaching of Physics - Waldemar Berej, Marek Budzinski . . . . .	462
3.5.2 - Exploring the sources of magnetic field and the interactions between them to interpret electromagnetic induction: a proposal of conceptual laboratory - Michelini Marisa, Vercellati Stefano . . . . .	466
3.5.3 - Secondary School Students' Use and Transformation of Arguments from an Energy Dilemma Text - Marina Castells, Aikaterini Konstantinidou, Sandra Gilabert . . . . .	473
3.5.4 - Progressions of students' mental models of magnetism across scale - David Sederberg, Anna-Leena Latvala, Anssi Lindell, Lynn Bryan, Jouni Viiri[2,9] . . . . .	489
3.5.5 - Towards effective teaching of weight and gravitation at schools - Hana Stein, Igal Galili . . . . .	496
3.5.6 - Inquiry-based physics education in French middle school - Jean-Marie Boilevin, Ludovic Morge, Alice Delsérieys . . . . .	503
3.5.7 - Content and Language Integrated Learning in Physics Teaching: Benefits, Risks, Requirements and Empirical Studies - Claudia Haagen, Martin Hopf . . . . .	511
3.5.8 - Magical Elves and Formulas as a key to technological inventiveness: The case of noncontact distance measurement - Dorothy Langley, Rami Arieli . . . . .	519
3.5.9 - Energy: an experiment-based route from context to concept - Paul Logman, Wolter Kaper . . . . .	528
3.5.10 - Collecting, organizing, representing and interpreting values of measurement in elementary school - Valérie Munier, H��l��ne Merle, Danie Brehelin . . . . .	537
3.5.11 - Development of Physics Demonstrations in Nagoya University - Jun-ichiro Yasuda, Yuichi Miura, Katsumi Senyo, Masahiro Mori . . . . .	544
<b>3.6 – Multimedia in teaching/learning . . . . .</b>	<b>551</b>
3.6.1 - Integrated e-Learning with remote experiments for engineering education in the era of networking - Franz Schauer . . . . .	552
3.6.2 - From linear text to hypermedia in Physics educational documents - V��ctor L��pez, Roser Pint�� . . . . .	572
3.6.3 - Interactive e-learning content for physics - Sergej Faletic, Gorazd Planinsic, Boris Horvat . . . . .	583
3.6.4 - Computer assisted kit-like modeling of physical systems - Herman Mann . . . . .	593
3.6.5 - Interactive online resources to teach Physics: quality criteria and teachers' expectations - Jorge Andrade Silva, Jos�� Paulo Cravino, Norberto Jorge Gon��alves . . . . .	601
3.6.6 - A modelling learning path, integrated in the secondary school curriculum, starting from the initial phases of physics education - Onne van Buuren, Peter Uylings, Ton Ellermeijer . . . . .	609
3.6.7 - High-Speed Video Analysis of Two-Dimensional Movement of Objects onto Fine Beads - Minoru Sato . . . . .	622
3.6.8 - The Virtual and Remote Laboratory for Snell's Law at the FisL@bs	

3.6.8 - The Virtual and Remote Laboratory for Snell's Law at the FisL@bs Portal - Luis de la Torre, Juan Pedro Sánchez, José Sánchez, Carmen Carreras, Manuel Yuste, Sebastián Dormido . . . . .	627
3.6.9 - Infrared sensors with multimedia - multimodal and pictured information processing - Raimund Girwidz, Michael Lippstreu . . . . .	634
3.6.10 - Self-reflection, comparative reflection and analogical reflection in the framework of metacognitive modelling activities using the Modelling Space technological environment - George Kritikos, Angelique Dimitracopoulou . . . . .	642
<b>3.7 – Learning out of school . . . . .</b>	<b>651</b>
3.7.1 - Babies' Response To Magnetic Interaction: An Exploratory Study - M. Celia Dibar, María Alejandra Aleman . . . . .	652
3.7.2 - Four Enhanced Science Learning Dimensions: The Physics& Industry Programme - Dorothy Langley, Rami Arieli, Bat Sheva Eylon . . . . .	657
3.7.3 - Energy for Everyone - Joel Rosenberg . . . . .	669
3.7.4 - Fun and Joy with Researching and Ruminating - Jurgen Durst, Angela Fosel, Gisela Anton . . . . .	675
3.7.5 - The Perception of Physics in Secondary School Students near Milan - Marina Carpineti, Michela Cavinato, Marco Giliberti, Nicola Ludwig, Laura Perini, Elena Veronesi . . . . .	684
<b>3.8 – Teacher education . . . . .</b>	<b>689</b>
3.8.1 - An Inquiry-Based Approach to Physics Teacher Education: the Case of Sound Properties - Claudio Fazio, Giovanni Tarantino, Rosa Maria Sperandeo-Mineo . . . . .	690
3.8.2 - Teaching-Learning about the physical basis of greenhouse effect and global warming in high school - Ugo Bessona, Anna De Ambrosisa , Pasquale Onorato . . . . .	696
3.8.3 - Teacher change in exploring representational approaches to learning science - Peter Hubber . . . . .	702
3.8.4 - Quantity/potential-related elementary concepts in primary school teacher education - Federico Corni, Enrico Giliberti, Cristina Mariani . . . . .	708
3.8.5 - Developing technological pedagogical content knowledge in pre-service science teachers through microteaching via inquiry based interactive physics computer animations - Mehmet Fatih Tasar, Betül Timur . . . . .	716
3.8.6 - Identifying pre-service physics teachers' misconceptions with three-tier tests - Derya Kaltakci, Ali Eryilmaz . . . . .	726
3.8.7 - How pre-service physics teachers interpret static and kinetic friction: a laboratory experiment - Ozlem Oktay, Derya Kaltakci . . . . .	733
3.8.8 - TPACK - a Prerequisite for Successful Technology Integration into the Classroom? - Hildegard Urban-Woldron, Martin Hopf . . . . .	742
3.8.9 - Community of prospective primary teachers facing the relative motion and PCK analysis - Marisa Michelini, Lorenzo Santi, Alberto Stefanel, Stefano Vercellati . . . . .	752
<b>Chapter 4 - Thematic analysis . . . . .</b>	<b>758</b>
4.1 Simple And Beautiful Experiments IV By LADY CATS And Science Teachers' Group - Masa-Aki Taniguchi, Tomoki Hashimoto, Takanari Sasaki et al. . . . .	759

4.2 “What Is the Wick in the Candle For?” – An Example of the Methodological Sequence in the “Eureka” Project - Irena Dvorakova, Leos Dvorak . . . . .	764
4.3 Teaching about Energy. Which Concepts should be Taught at Which Educational Level? - Paula R.L. Heron, Marisa Michelini . . . . .	770
4.4 - Discussion of Strand on Energy in Primary School - Marisa Michelini . . . . .	771
4.5 - Discussion of Strand on Energy in Lower Secondary School - Bat Sheva, Eylon Yaron Lehavi . . . . .	772
4.6 - Discussion of Strand on Energy in Upper Secondary School - Alberto Stefanel . . . . .	774
4.7 - Contributions to the Workshop Is it possible to teach energy in preschool and primary education? - Dimitris Koliopoulos . . . . .	775
4.8 - Energy for Everyone - Joel Rosenberg . . . . .	776
4.9 - An artifact for the discussion. What has changed? -Energy as the language of changes - Bat Sheva Eylon, Yaron Lehavi . . . . .	777
4.10 - Approaches and learning problems in energy teaching/learning: an overview - Marisa Michelini, Alberto Stefanel . . . . .	779
4.11 - Position paper: Energy as the language of changes I . . . . .	789
<b>Chapter 5 - Complementary aspects . . . . .</b>	<b>800</b>
5.1 - An instrument for measuring self-efficacy beliefs of Secondary school physics teachers in Brazil - Marcelo Alves Barros, Carlos Eduardo Laburú , Fábio Ramos da Silva . . . . .	801
5.2 - Remote Experiments for Teaching Quantum Physics within the Integrated e-Learning Strategy - Pavel Brom, Frantisek Lustig . . . . .	808
5.3 - Ethical issues in Physics: the convergence between STS and History of Science in the example of Radioactivity - Marines Domingues Cordeiro, Otavio Bochecho . . . . .	817
5.4 - Reform of curriculum in Slovakia as a challenge for physics education - Peter Demkanin, Sona Chalupkova, Viera Lapitkova, Zuzana Suhajova . . . . .	822
5.5 - Computer assisted symbolic calculations in university physics courses. - José Luis Jiménez, Ignacio Campos, Gabriela Del Valle, Guadalupe Hernández. . . . .	827
5.6 - Four experiments on magnetic field at four Euros – Low-cost demonstrational experiments on Classical Electrodynamics for future physics teachers - Vera Koudelkova, Leos Dvorak . . . . .	833
5.7 - Computer simulations enhance qualitative meaning of the Newton’s second law - Silvana Mico, Jorgo Mandili, Valbona Tahiri, Rezart Muco. . . . .	841
5.8 - Electronic Database of Solved Tasks in Physics Zdenka Koupilova, Dana Mandikova, Marie Snetinova . . . . .	850



## Preface

In August 2010 the city of Reims and its university organized the international conference “*Teaching and Learning Physics Today: Challenges? Benefits?*” with the Groupe International de Recherche sur l’Enseignement de la Physique (GIREP), the International Commission on Physics Education (ICPE) and the group on Multimedia in Physics Teaching and Learning (MPTL). These three bodies share very important goals, such as contributing to improve the teaching/learning of physics at all levels, campaigning for the exchange of information covering all aspects of physics education, supporting innovation in teacher education methods in order to take advantage of the progress of the research in physics as well as in physics education.

The conference was supported and endorsed by International Union on Pure and Applied Physics (IUPAP), European Physical Society (EPS), the University of Paris Diderot Paris 7 and its Laboratoire de Didactique André Revuz (LDAR), the Société Française de Physique, the French Union des Professeurs de Physique et de Chimie (UdPPC) and the laboratory GRESPI.

The organizers of the conference were fortunate to benefit from the combined experiences of over three hundred participants from all over the world, representing researchers in various fields of physics, physics teachers of all levels and PHD students from fifty countries. The challenges in teaching and learning physics today, referred to in the title of the conference, were described, compared and carefully examined. The subject of benefits of teaching and learning physics also produced 230 contributions of great interest. A broad range of pioneering proposals and physics education research originated suggestions aimed at helping teachers in improving their work by developing scientific reasoning using simple experiments, exploring existing (free or easily available) multimedia resources, as well as taking advantage of fascination of science and using history of science as a means of including physics in general human achievement.

The richness of contributions presented and the help of the University of Udine allowed GIREP to produce a selected paper book containing the 10% of the best presented contributions. Long and detailed was the peer review process to produce this book. The interest and the quality of the other contributions presented in the Conference convinced GIREP to produce this selected paper Conference Proceedings. This web proceeding e-book contains paper submitted to the process of peer review and accepted by two anonymous referees.

The chapter 1-Background aspects, 2-Special aspects and 4-Thematic analysis have the same contents of the book, containing respectively the plenary talks, the contributions to the Symposia and the contributions produced by Workshops held in the Reims Conference. Chapter 3 on “Topical aspects” contains the selected papers of the oral contributions presented in seven times seven parallel oral presentations sessions and it is organized in the following sub-topics: History and Nature of Science, University teaching / learning proposal, Modern and contemporary physics, Experiment proposals, New teaching/learning methods and Inquiry Based Learning, Multimedia in teaching/learning, Learning out of school, Teacher Education. The last chapter 5-Complementary aspects contains the EPS awarded poster and some very appreciated poster contributions.

We thank the anonymous peer reviewers, whose important help may not always be evident, but is fundamental.

It goes without saying that we are very grateful to all the participants for stimulating discussions, important advice, constructive criticism and patient encouragement.

We hope that this web proceedings book will be useful to those involved in physics education research, as well as those who practice the teaching of physics every day.

Wanda Kaminski and Marisa Michelini

# Chapter 1

---

Background aspects

## The International Commission on Physics Education: Challenges and Opportunities

Pratibha Jolly<sup>a</sup>

Chair, International Commission on Physics Education (2005-2011)

<sup>a</sup>Miranda House, University of Delhi, Delhi, India

### ABSTRACT

Established in 1960, ICPE, Commission 14 of IUPAP, was born out of the realization that unlike research speciality areas, physics education lacks spontaneous international linkages even though teaching of physics, and education of physicists, is of concern to all and there is great deal of commonality in problems faced by diverse communities. The primary mandate of ICPE is to promote the exchange of information and views among the members of the international community of physicists in the general field of Physics Education. The presentation elaborates on the mission objectives and various activities, in particular on the recent efforts made in establishing strong regional cooperation and networks with global outreach. It delineates the commission's concerns about making programs more inclusive; efforts towards capacity building of physics educators; mechanisms for effective coordination between physics education organizations worldwide; initiatives for sharing of resources and expertise for optimum outreach; and providing support to potential regional leaders and envisioning global networks. These efforts have led to adoption of a resolution by IUPAP urging all nations to emphasize the importance of active learning methods, hands-on and laboratory activities. A memorandum of understanding between the Abdus Salam International Centre for Theoretical Physics, Trieste and IUPAP will enable furtherance of the action plans that emerged from the World Conference on Physics and Sustainable Development, sponsored by IUPAP, ICTP and UNESCO in 2005. The commission will spearhead organization of PHYSWARE series of workshops promoting active learning and use of appropriate technologies, especially in the developing world. It is hoped that these educator workshops will build a critical mass of educators who can assume the role of regional leaders and strengthen physics education programs. Future plans also include organization of a World Conference on Physics Education, once every four years, in collaboration with key organizations.

### INTRODUCTION

This article is a tribute to the International Commission on Physics Education (ICPE) as it celebrates fifty vibrant years of its existence. It is a remarkable coincidence that this year ICPE joined GIR EP and MPTL in sponsoring and organizing its annual international conference *Teaching and Learning Physics Today: Challenges? Benefits?* at the historic city of Reims – renowned also as the Champagne capital of the world – mere 45 minutes train ride from Paris, the city where ICPE came into being. In my capacity as the current chair of the commission, it is a privilege to recount the remarkable story of ICPE, reflect on its mission and lay out a considered roadmap for future.

The parent body of ICPE is the International Union of Pure and Applied Physics (IUPAP) which has, since its inception in 1922, played a vital role by providing a common platform to physicists from all across the world. Its broad objective is to simulate and facilitate international cooperation in physics and the worldwide development of science by encouraging

research and education. It works through several commissions responsible for overseeing exchange of information and activities related to select physics domains. The Union is governed by its General Assembly which meets triennially to elect members of specialized commissions and approve their activities [1].

## GENESIS

The International Commission on Physics Education (ICPE) came into being as the 14<sup>th</sup> Commission of IUPAP in 1960. It was born out of the realization that unlike research speciality areas, physics education lacks spontaneous international linkages even though teaching of physics and education of physicists is of concern to all.

Pioneering efforts to resolve this anomaly were led by William Kelly and Sanborn Brown who then served as the Chairman and Secretary of the Committee on Apparatus for Educational Institutions of the American Association of Physics Teachers (AAPT). It was on a fateful day in June 1958 as the two strolled down New York continuing their conversation after dinner together that they came up with the idea of an International Conference on Physics Education. The launch of Sputnik had triggered a new era heralding excitement about rapid growth of knowledge in physics and a sudden spurt in undergraduate enrolments in physics degree programs. It also raised simultaneous questions on the adequateness of national manpower resources and state of education in science and engineering leading to greater rapport between teaching and research physicists. Rising public esteem for physics, greater financial support, national emphasis on innovation and curriculum reform brought physics education to the centre stage. In this changed scenario, there was a felt need for change in almost every country. Given the common concerns about physics education, there was also a felt need for greater international cooperation and collaboration.

Networking with renowned physicists in IUPAP and American Institute of Physics (AIP), Brown and Kelly established a task force to organize the first ever IUPAP sponsored International Conference on Physics Education at the UNESCO House in Paris towards the end of July 1960. Further support came from co-sponsors and agencies across the world including the Organization for European Economic Cooperation, the National Science Foundation of the U.S.A., the Asia Foundation, and UNESCO which has continued to play a vital role. A meeting of the organizing committee was held on 30 June 1958 at Konstanz, Germany with representatives from US, UK, Germany, Italy and Japan.

The Paris conference proved to be of sufficient global interest. Held from 28 July to 4 August 1960 at the UNESCO House, it was attended by 86 participants representing 28 different countries. The conference ended by formulating a number of landmark resolutions. Amongst these was the recommendation to IUPAP that it should take appropriate action, possibly in collaboration with other international organizations, to establish an international committee of professional physicists to accept responsibility for:

1. The collection, evaluation, and coordination of information and the stimulation of experiments at all levels of physics education.
2. The suggesting of ways in which the facilities for the study of physics at all levels might be improved in various countries.

3. The collection and evaluation of information on methods used for the assessment of standards of performance of students of physics and for the evaluation of the qualifications and effectiveness of teachers of physics.
4. The giving of help to teachers in incorporating modern knowledge in their courses.
5. The promotion of the exchange of information and ideas among all countries by methods that would include the holding of international conferences.

Significantly, the conference in its final resolutions also recommended a major improvement in the degree of professionalism and the working conditions of physics teachers, and a closer relationship between universities and secondary schools in the area of physics education.

Things moved at an astronomical pace. It is a measure of success of the Paris conference and the commitment of all players to the cause that a month later on 9 September 1960 at the X General Assembly of IUPAP held at Ottawa, the International Commission on Physics Education came into official existence; the membership of the new Commission coming primarily from the chief organizers of the defining conference.

In conformity with the stated aims of IUPAP, promotion and support of international conferences was seen as an effective instrument by which ICPE could achieve its own objectives. Interestingly, over the years, the main themes of the 1960 Paris conference – Physics as part of a general education; Examinations and the selection of students; Curricula; Laboratory; Physics for other sciences and engineering; Training for teaching and for research; Films and television as teaching aids – have proved to be of enduring interest, granting the modifications of interest engendered by technological advances in changing times.

Riveting accounts of creation of ICPE [2] and its growth story over the next twenty years [3] are available in the articles by key players, William Kelly and A. P. French. In a preface to a collation of ICPE publications made available on the website in 1988, Len Jossem wrote: “Every organization has multiple histories – oral and written, formal and informal, official and personal, factual and mythic. Each provides a particular point of view and special way of understanding the organization, its origins and development, its policies and activities, and of understanding also the various roles played by the persons who have influenced it and who have been influenced by it.” This article contributes towards documenting the evolution of the organization as witnessed in a decade of association since 2002.

## NEW DIRECTIONS IN PHYSICS EDUCATION

Over the last five decades, there have been in Physics Education discernible changes of paramount significance. Reporting to the 1993 IUPAP assembly, then Chairman Paul Black, identified four main trends as affecting the nature of physics education at all levels.

1. ***Changes in Physics as a Subject.*** There is a need to help teachers of physics keep pace with the progress in domain knowledge and better understand, both, the methods and the concepts. Advances in the discipline also make it imperative that both, teachers and students, get a flavour of excitement which inspires professional physicists.
2. ***Research into How Students Learn.*** Seminal work by Physics Education Research Groups across the world has generated a greater understanding of cognitive aspects of teaching-learning. In depth investigations have generated a wealth of data on the naïve

beliefs students bring to the classroom and provided insight into how students learn new concepts and solve problems. This has helped build what many now call the *Science of Physics Teaching*, an area of work characterized by its own vocabulary, research methodology and scientific rigor. Curriculum development has acquired a research-base that incorporates models of the student, the learning process and instruction coupled with suitably designed instruments for assessment. Increasingly, the view of teaching-learning is becoming student centric. It is now believed that to engender conceptual understanding, students' preconceptions need to be explicitly challenged and the resulting conflicts with expert viewpoint need to be resolved before new ideas can take root. All this requires active mental engagement. Then the efficacy of the traditional lecture is questionable. Research shows that domain knowledge combined with a natural flair for exposition by itself does not necessarily make a teacher effective; also important is pedagogic knowledge and the underpinning model of instruction.

Inasmuch as teaching of physics is of concern to the entire community of physicists, there is an urgent need to communicate the new findings of physics education research in usable forms to various players. It is imperative that serious efforts be made to bridge the gap between the viewpoints of the domain expert, the teacher, the education researcher and the policy maker.

- 3. *Changes in the Context and Goals of Physics Teaching.*** Although study of physics per se continues to be of vital interest and contemporary applications of physics span many exciting areas, the traditional physics course is no longer able to attract the numbers it used to. Data shows this to be a global trend triggered by rapid changes in the work place that have changed the expectations of students as also the profile of potential employers. No longer is it prudent to teach physics to all students as one would to a future physics researcher or specialist. This realization is beginning to impact physics teaching in two directions. One, there is need to impart to all students a basic threshold of scientific acumen crucial for life as a responsible citizen in a science and technology driven society. Then there is a renewed effort to design learning experiences that make learning a joy and convey the excitement of science in the context of problems of relevance in everyday life. It has become crucial to build capacity early enough for independent lifelong learning as well as social skills for collaborative teamwork and better communication. Societal issues make it imperative that some emphasis is placed on teaching the concept of evidence – how data and evidence are to be evaluated to arrive at judgments. Two, there is a need to reach out to wider special interest groups by designing curricula with a strong component linking physics to other disciplines ranging from medicine and life sciences to sports, music and arts. Summarizing, physics for new fields and new students is the need of the day.
- 4. *Changes in How Physics is Communicated.*** With the advent of computer-based technologies, in particular the internet, there is an additional shift in how knowledge is communicated. Research-based curricula have a strong component of technology input. The full gamut now includes professional general purpose application software and visualization tools, computer simulations, computer-based data-acquisition systems and interfaced laboratory experiments, web-based learning materials and comprehensive virtual laboratories. In changing demographic profile of the student, also on the scene is the distance learner. There is a need to train teachers in the use and development of these materials. Further, there is a need to realize the full potential the internet as an instrument for linking communities of physics educators and publication of widely accessible

resource materials. The last has major implications for developing countries or those with a poor tradition of innovation in education or limited capacity for access to works of significance from elsewhere.

## **MANDATE**

The above developments in physics education have impacted the activities of ICPE. In addition to the domain knowledge, pedagogic issues are considered to be of prime importance. It is of interest to compare and contrast the mission statement formulated in 1960 with what is adopted today by ICPE:

The primary mandate of the Commission is to promote the exchange of information and views among the members of the international community of physicists in the general field of Physics Education including:

- collection, evaluation, co-ordination and distribution of information concerning education in the physical sciences at all levels;
- information relative to the assessment of standards of physics teaching and learning;
- suggesting ways in which the facilities for the study of physics at all levels might be improved, stimulating experiments at all levels, and giving help to physics teachers in all countries in incorporating current knowledge of physics, physics pedagogy, and the results of research in physics education into their courses and curricula.

## **FRAMEWORK**

Currently IUPAP has representation of more than 60 countries on its 20 commissions, 4 affiliated commissions and various work groups, representing research domains of physics with the very best physicists as members. Funding comes from member countries which hold shares in IUPAP usually in proportion to the size of the physics community and its activities. At the triennial General Assembly, commissioners are chosen from those nominated by Physics Academies or equivalent apex bodies representing communities of physicists of member countries for a period of three years. This makes the commission qualitatively different from individual member based societies and associations of physics educators, such as GIREP or AAPT. IUPAP commission chairs and executive council meet annually to review, plan and finance activities of all commissions. Then ICPE is strongly bound to its parent body. However, within IUPAP, in recognition of importance of its mandate, ICPE enjoys an equal status and if anything, enhanced support. It is amongst the two commissions that are invited to make presentations at each General Assembly.

The changing demographics of the commission is of interest. Over the last five decades, the composition of the commission has changed significantly. In 1960 ICPE had 7 members and 3 Associate Members, mostly from industrialized countries. Now in 2010, there are 14 members from 61 IUPAP countries and 4 associate members representing greater geographic, cultural and professional diversity. Since inception, there have been only 8 women commissioners, 2 women associate members. The author is the first woman chair of the commission. A concerted effort is now under way to increase the presence of women on ICPE and certainly there will be more women commissioners when ICPE is next reconstituted in 2011. Also, the developing world will be increasingly better represented.

## ACTIVITIES

The Commission members meet annually at the sidelines of ICPE conference. In addition to drawing the charter of activities, the opportunity is used to share experiences about the state of physics education in member countries and forge an academic liaison to further the mission objectives. Shared commitment, sustained communication, cooperation and strong bonding between commissioners has been central to the success of ICPE. The charted path of ICPE has impacted physics education globally in many significant ways.

**Conferences:** Inasmuch as promotion and support of international conferences is one of the main ways in which the commission seeks to achieve its aims, the list of ICPE supported conferences is long. Over the years, there has been a distinct shift in the profile of the participants and the foundations on which the conference themes rest.

It is important to note that research in physics education is no longer considered the sole prerogative of Departments of Education, meant for scaffolding teaching of school science. There is considerable thinking about pedagogic issues and curriculum development even at the tertiary level. Many Departments of Physics at reputed Universities take pride in offering Ph.D. programs in Physics Education and increasingly, action research is being carried out by professional physicists and teachers in their own classrooms. Then the conference organizers and many participants tend to be those who are professionally engaged in Physics Education Research or Curriculum Development in a major way. The touchstone of conferences in recent times has been the presentation of research on students learning that underpins development work and the need for teacher education. There is a strong emphasis on hands-on experiences, workshops and group discussions that demonstrate the new ways of thinking. Consequently, the conferences are important milestones in progression of the discipline and the proceedings provide a wealth of field tested ideas which can be easily put into praxis. This trend has an impact at all levels.

A collation of the conferences that have been organized by the commission is available on its website. The location and the theme give a flavour of the educational concerns and also the outreach. An important concern has been on making participation more inclusive. For instance, there is yet the need to enhance the participation of women in physics and increase opportunities for early career physics educators and researchers – including school teachers and teacher trainers – particularly those from the developing countries. Following the IUPAP policy on conferences, the commission ensures that women are included on the organizing and program committees and as invited speakers. The commission also looks for ways to enhance greater participation of young, or more appropriately, early career physics education researchers and educators in its conferences.

The commission has traditionally been supporting the Inter-American Conference on Physics Education (IACPE) organized once every three years in a Latin American Country, by the Inter-American Council of Physics Education. The tenth such conference was held in July 2010 in Colombia. This initiative has served an important purpose of promoting the cause of physics education and providing a unique opportunity for sustained regional cooperation. Additionally, several of the GIREP conferences have received sponsorship in form of financial assistance or endorsement.

Experience has shown that the best way of propagating the cause of physics education has been to organize conferences on physics education in countries which have rarely or never done so



before. Thus in the past few years, we have organized conferences in South Africa (2004), India (2005), Morocco (2007), and Thailand (2009). The point is illustrated herein through the story of ICPE conference in Delhi in August 2005 which galvanized the Government.

The year 2005 was momentous for ICPE. UNESCO had declared 2005 as the *International Year of Physics* (IYP) to commemorate hundred years of Einstein's seminal research papers published in 1905. The euphoria of world-wide celebrations brought ICPE and its activities centre stage and provided tremendous opportunities to work towards fulfilment of the larger objectives. The IYP also brought closer all stakeholders; those in schools, universities, research laboratories, national societies, government, science museums and other non-formal agencies engaged in the area of physics education. Of particular significance was the international solidarity. Several international organizations worked collaboratively to setup spectacular global events with large scale participation from across the world. There was something for everyone.

ICPE 2005 was seen as the nation's contribution towards achievement of the stated mission objectives of IYP. Befittingly titled *World View on Physics: Focusing on Change* ICPE 2005 brought together about 350 participants from 30 countries, with vibrant participation from the neighbouring countries of South Asia, East Asia and other developing countries where Physics Education Research is still in its infancy. In keeping with the celebratory spirit of the International Year of Physics, the Inaugural Day Program on 22 August was designed to be special. Directors and heads of departments, physicists, researchers and physics educators from various research and educational institutes were specially invited. Also invited were a large number of undergraduate students and high school students. The premiere conference hall was filled to its capacity of 1200. The conference was inaugurated by the President of India, Dr. A. P. J. Abdul Kalam, himself a scientist. Speaking of *Injecting beauty of science in teaching*, with insightful examples of the questions posed to him by students and the strategies adopted by great teachers of science, Dr. Kalam generated surprise and aweome delight amongst the diverse international audience. The full text of his speech appeared in the October 2005 ICPE Newsletter [4]. This was followed by an eloquent keynote address, *Communicating Physics: a personal account*, by Nobel Laureate Horst Stormer from Columbia University and Lucent Technologies. He further elaborated the process of scientific learning and discovery with magnificent historic and pedagogic insight. The day included other talks providing a glimpse of physics at the frontiers, the wide ranging impact of physics, the future of physics, and of course an overview of the concerns of physics education research by Edward F. Redish, University of Maryland, who in his engaging and highly interactive talk focused on *Changing student ways of knowing: what should our students learn in a physics class?*

On later days, the technical sessions open to registered members, dwelt in depth on changes in the ways of teaching-learning of physics; in the understanding of the teaching-learning process; in the content of physics as a discipline, and in the context of physics teaching. The presence of some of the best known physics education researchers, innovators, curriculum developers and practitioners from the classroom ensured successful elaboration of the conference themes. Those who were attending a Physics Education Conference for the first time admitted that the deliberations had radically altered their knowledge and epistemological beliefs about the teaching-learning process *per se* [5].

The paradigm shift was palpable. Dr. R Chidambaram, the Principal Scientific Advisor (PSA) to the Government of India had consented to be the Patron of the conference. He stayed tuned in to the entire proceedings. On his behest, several key agencies including the National Informatic

Centre (NIC), EduSAT and Indira Gandhi National Open University (IGNOU) worked together to web cast the sessions and also transmit them live to several nodal centres across the country through the Educational Satellite Program, a first for any conference. IGNOU still continues to beam archived talks given by the eminent conference speakers. Without the government will, at that point in India, this exercise would have been hugely expensive and formidable. In a quick follow up, as the organizer of this conference the author was asked by the office of PSA to organize a brainstorming meeting of select educators across institutions in India to explore the possibility of setting up a consortium and a vibrant program for Research and Innovation in Physics Education (RIPE).

These initiatives were born of the realization that India lacked a critical number of those engaged in PER. Soon after, the Department of Science and Technology (DST) invited the author to submit a proposal for establishment of a Centre for Research and Innovation in Science Education (RISE). Generous funding followed and the Centre was indeed established at Miranda House, *albeit* in project mode. To celebrate the centenary of Professor D S Kothari, renowned physicist, administrator, institution builder, educationist with unparalleled vision, the Centre is named after him and fondly referred to as DSKC. It would not be inappropriate to say that the Centre took nearly 50 years to be established as D S Kothari was India's representative to the ICPE conference in 1960, an early commission member and organizer of the first Indo-American conference on *Physics Education and Research in India* sponsored by government agencies in both countries. It brought together 37 Indian physicists and 20 physicists from US to Srinagar, Kashmir in 21-30 June 1970 to dwell on challenges and opportunities. Interestingly, Len Jossem's retrospective *Srinagar 1970 to Delhi 2005: Thirty five years of change in physics and physics education* presented at ICPE 2005 provided a convenient baseline for reflecting on the changes over 35 years. While much has changed during the time, many of the old problems remain and compel us to look for new answers to fit new contexts.

ICPE 2007 in Marrakech, Morocco, imbibed the experience from Delhi. Morocco is not an IUPAP member country. The organizer Khalid Berrada worked against all odds to ensure all stakeholders were on board from the planning stage. This conference also resulted in significant project grants for science education programs. It thus appears that we can catalyze similar interest as we travel across the world. We look forward to the impact of the upcoming conference *Training Physics Teachers and Educational Networks* which takes place from 15 to 19 August 2011 in Mexico City. In a build up to this conference, Cesar Mora has already reached out beyond Mexico to the entire region. Latin American countries have traditionally been collaborating and organizing regional conferences but now they also stand organized under LAPEN, the Latin American Physics Education Network. Another conference in the region is already being planned and will be in 2013 or 2014 in Brazil or Argentina. Histories matter and give an opportunity to assess progression. If plans materialize, ICPE would return after five decades to Sao Paulo, the city that hosted the second ICPE conference in 1963.

***The Medal of the International Commission on Physics Education:*** In 1979, on suggestion of George Marx, the commission instituted a medal to commemorate outstanding contributions to physics education that have extended over a considerable period of time; are major in scope and impact; and that transcend national boundaries. The medal is shaped by the Hungarian artist Miklós Borsos. The face shows a



symbolic picture, the interaction of human beings with forces of nature, represented as four elements of the ancient Greek philosophers – earth, water, air and fire, the last one being symbolised by powerful rays of sunlight.

The medal is given every one or two years. The recipients include well known physicists, educationists and two organizations, namely, Eric Rogers (1980), P. Kapitza (1981), J.R. Zacharias (1983), Victor F. Weisskopf (1985), John Logan Lewis (1987), International Physics Olympiad (1991), Nahum Joel (1992), E. Leonard Jossem (1995), George Marx (1997), Paul Black (2001), Lillian McDermott and Tae Ryu (2002), Laurence Viennot (2003), Svein Sjöberg (2005), Jon Ogborn (2006), Priscilla Laws (2007), UNESCO (2008), Ton Ellermeijer (2009). All have played a pioneering role in physics education, and more importantly, in strengthening international cooperation.

This list of laureates includes four women, each renowned for pioneering work and immense dedication. Given the wide ranging and transformational impact of laureates, it is also befitting that the International Physics Olympiad and UNESCO have been recognized by the commission.

The ICPE medal for 2010 is being awarded at this conference to Gunnar Tibell, Professor Emeritus at University of Uppsala, Sweden. An experimental nuclear physicist, he is well known for his contributions as the Chairman of the Swedish Physical Society 1989-95, and the European Physical Society, where he played an influential role with his strong advocacy for the cause of physics education at all levels. As Chair of the EPS Physics Forum and later within the Physics Education Division, he vigorously supported a wide range of educational activities, including pre-university education, student mobility programmes, international exchanges for physics teachers and student competitions. He is especially known for spearheading the International Young Physicists Tournament for ten years as President from 1999. Tibell served as a member of ICPE from 1999 to 2002 and was Chair from 2002 to 2005. His deep engagement with EPS and other international physics organizations led to greater synergy that strengthened global exchanges for development of physics education programmes.

Citations for all laureates are available on the ICPE website. These chronicle not just individual achievements but also establish benchmarks and global milestones in the evolution of physics education.

***IUPAP Young Scientist Prize in Physics Education:*** Over the last three years, at the behest of IUPAP, several commissions have introduced the Young Scientist Prize in their discipline to recognize merit in researchers who are within eight years of their PhD (with appropriate adjustments), on the basis of work published or accepted for publication in a refereed journal. Following suit, ICPE has also decided to award up to three prizes in three years, each consisting of USD 1000, a medal and a certificate. The prize will be announced and presented at a conference sponsored by the commission and the prize money will normally be given as a contribution towards the expenses for attending the conference where this work would also be presented.

Instituting this award has been a real challenge, given the vast scale of physics education and diversity of work profile of physics education researchers, educators and those engaged in outreach. After intense deliberations, it was decided that research will include educational development such as development of instructional materials as well as Physics Education Research. Further, the impact of research/development will be judged in local contexts. R&D experiences in informal education will be considered at par with work in formal settings. For

formal education there will be no restrictions on the level at which the research or development was conducted. The selection will rest on carefully established assessment procedures. We hope to give the first award in 2012 at the upcoming World Conference on Physics Education in Istanbul.

**The Newsletter of the ICPE:** Since 1977, with funding from UNESCO, the commission has regularly been bringing out a Newsletter twice a year, in April and October. Consisting of 12 pages, it includes articles, reports, announcement of conferences, events and provides an effective channel for communication of international activities and thrust directions in physics education and its research.

The newsletter has the distinction of having renowned editors since its inception. The list includes John Lewis (1977), Anthony P French (1981), Peter J Kennedy (1984), George Marx (1987), and Edward F Redish (1995), and Vivian Talisayon (1999). Currently, Ian Johnston who founded the Sydney University Physics Education Research (SUPER) Group is editor since 2005.

Till 2005, the newsletter used to be sent free of charge to a mailing list of about 2000 recipients across the world. Now, the preferred mode of distribution is electronic via email and wider electronic access is possible from the ICPE website. Paper copies are printed as and when required for distribution at meetings, workshops or conferences.

**Other Publications:** Since its inception, ICPE has endeavored to bring out resource material for physics educators. In the initial years, the commission members collaborated with UNESCO to bring out valuable and highly cited resources [6-12] such as:

- *Survey of the Teaching of Physics at Universities* (1966) – a 400 page report on physics teaching in Czechoslovakia, Germany, France, USSR, UK, US;
- *Source Book for Teaching School Physics* (1972);
- *Source Book for Teaching School Physics*, John Lewis (Editor), 1975;
- *New Trends in Physics Teaching Volumes I to IV* published in the seventies and eighties; and
- *Physics Examinations for University Entrance: An International Study*, Paul Black (Editor); this is a report of an ICPE commissioned survey of assessment in eleven countries;
- *The Role of the Laboratory in Physics Education*, J. G. Jones and J. L. Lewis (editors), 1980.

Equally successful have been the ICPE centenary volumes dedicated to Einstein and Neils Bohr, namely,

- *Einstein: A Centenary Volume* edited by A.P. French. This was translated into French, German and Japanese.
- *Niels Bohr: A Centenary Volume*, edited by A.P. French and P.J. Kennedy.

In the last decade, the commission has brought out excellent educational resource books with teacher education as focus.

- *Physics 2000 – as it enters a new millennium*, Editors: Paul Black, Gordon Blake and Leonard Jossem; this is a compendium of reviews by leading physicists in IUPAP commissions giving a flavour of the state-of-art in their fields.
- *Physics Now*, Editor: Jon Ogborn; this includes the updated version of the articles in *Physics 2000*.

- *Connecting Research in Physics Education with Teacher Education, Volume 1*, Editors: Andrée Tiberghien, E. Leonard Jossem, Jorge Barojas, 1998; this carries invited articles by physics education experts renowned for their pioneering work in the area. It has proved to be a timeless resource as the research-based pedagogic insight it provides remains universally valid even today. Freely made available to the physics education community in an electronic form at the Commission's website and also distributed on CDs at the commission's conferences, the book continues to be widely accessed and downloaded from across the world and has been translated into several European languages.
- *Connecting Research in Physics Education with Teacher Education, Volume 2*, Editors: Elena Sassi and Matilde Vinciteni, 2008. The reported pedagogic importance of Volume 1 as a resource book and its continuing usefulness led the commission to conclude that it would not be appropriate to think in terms of an update. Rather, there was felt a need for a second volume covering topics not discussed, many of which have become salient since the book was first prepared. Much more than a compendium volume, beautifully conceptualized, this book is of great significance in its own right with articles equal in importance and usefulness. The book can again be freely downloaded.

The above publications, conceptualized as theme based collation of articles, have provided an opportunity for a long term world-wide collaboration. The editors of these books have all been individuals with vision, energy and zest for hard work, characteristics critical for turning an idea into a product. With immense skill, they have converted this endeavour to be much more than mere collation of commissioned articles. The contributors have given liberally of their time and expertise, participating in the creation of this resource with a passionate belief in the larger cause of teacher education. We hope the publication will catalyze vibrant discussions, generate further exchange of experiences, impact praxis and foster greater collaboration amongst physics teachers at all levels, across the world.

It is important to mention here that the parent organization IUPAP and UNESCO have generously supported the commission's publication ventures by providing access to adequate finances. Grants have allowed us to print *Physics Now* and more recently, volume 2 of *Connecting Research in Physics Education with Teacher Education*. This work was undertaken in Delhi. Copies are available on request from the author.

**Website:** The Commission's website is currently being maintained by Dean Zollman, Secretary ICPE at Kansas State University Physics Education Research Group website [13]. All ICPE publications and commission reports to IUPAP are available at this site. The site maintains a record of the statistics of hits. These indicate the interest in ICPE publications continues to be high.

**Working Groups:** The commission's meetings on the sidelines of ICPE conferences provide a valuable occasion for members to meet, and motivate creation of networks of talented individuals and experts from across the world. Self-organized working groups have from time to time been actively engaged in furthering our mission objectives. The focus has variously been on

- *Collection of information about physics teacher education degree programs at various universities around the world.* (Talisayon – chair, Alarcon, Luo, Pietrocola). The preliminary report of the study was presented at the ICPE 2006 conference in Tokyo as a plenary talk.

- *Increasing participation of school teachers in physics education meetings* (Pietrocola – chair, Zollman, Schlichting, Dissanayake). As a result of the efforts of this group, for the first time at an ICPE conference, a workshop titled *School Teachers' Session* was organized at ICPE 2006 Conference in Tokyo wherein specially invited school teachers from Japan, Brazil, and Korea exchanged their experience and ideas on Physics Education. The participating teachers were encouraged to explore the possibility of establishing an international network among school teachers. The plan is to continue this effort by organizing special events for school teachers at each conference.
- *Collating publications on physics education research* (Jolly – chair, Zollman). The group aims to identify select resources of seminal importance for use by physics educators worldwide and the best mode of dissemination. Efforts are underway to collect and make available the earliest ICPE publications in electronic form.
- *State, Standing and Recognition of Physics Education Research around the World* (Lambourne – Chair). Based on comments by several members of the commission on the dismal standing and support for physics education research in several countries, the commission is looking forward to collecting data that can form the basis of recommendations for policy change.

**Links to Scientific Bodies and Groups:** As part of policy, ICPE has proactively fostered and strengthened links to many different organizations, groups and societies devoted to physics education, mathematics education, and more generally, science education – both global and sometimes regional in character – with aims wholly or partly identical to those of our Commission.

- **UNESCO:** The ICPE 2008 medal was awarded to UNESCO to honour the proactive relations with UNESCO since the inception of the commission. A UNESCO official is an associate member of the commission. It has continued to fund the publication of the ICPE Newsletter since it was first launched. Particularly rewarding has been the cooperation in organizing the *World Conference on Sustainable Development (WCSD)* at Durban in October 2005 and collaborative efforts in implementation of the action plans that have led to organization of several Active Learning Workshops in the developing world.
- **GIREP:** Groupe International de Recherche sur l'Enseignement de la Physique (GIREP), the International Group for the Advancement of Physics Teaching, is a strong partner. In several conferences and seminars of this group, ICPE members have been given main roles in the planning. ICPE and GIREP executives keep each other well informed about the activities of respective bodies. Whenever the opportunity arises, the President of GIREP is invited to participate in the ICPE annual meetings. A task group has for sometime now been exploring areas of further collaboration in addition to organization of conferences.
- **EPS:** The European Physical Society (EPS) along with GIREP is a major force in advancement of physics teaching. The organizations have collaborated often in sponsoring conferences on Physics Education and also invited ICPE to join in the endeavour; ICPE is represented at these events by several members. One of the ICPE commission members is also the current chair of the EPS Physics Education Division while another is member of the board. At the GIREP conference in August 2008 at Cyprus, a special session was devoted to discussing closer cooperation between various organizations, especially the EPS-PED.
- **EUPEN and STEPS:** Although the European Education Network (EUPEN) has now ceased its activities, the follower STEPS (Stakeholders Tune European Physics Studies) and ICPE remain in close contact.
- **AAPT/APS:** The American Association of Physics Teachers (AAPT) and the American Physical Society (APS) are lead international players with well established programmes and

practices that are exemplary. At the tertiary level, the US has one of the most vibrant physics education research programmes. The membership base is enormous and any outreach to physics educators or researchers must necessarily draw on the expertise and resources available within this mass. Personal links between ICPE members and these organizations make it easy to keep information channels open. Several synergistic activities are on the anvil. ICPE is exploring the possibility of an ICPE conference in US dovetailing an AAPT Summer meet for enhanced global participation. The suggestion emanates from the historic success of ICPE 1995 at University of Maryland, College Park which successfully leveraged this model.

- **AsPEN:** The Asian Physics Education Network (AsPEN) was established in 1981 on a recommendation of UNESCO in order to contribute towards the overall development of university Physics Education in the Asian region. During the first phase, the ASPEN activities focused on projects for development of equipment, curriculum and text books, audio visual material, and research and evaluation on a national, regional and international level. However, since 1991, the emphasis has been on organizing Active Learning Workshops on Physics Education per se including a variety of themes in member countries. Several of the Asian members of the commission have also served as national points of contact and the executive board of AsPEN. They have contributed towards organization of Active Learning Workshops in the region. To strengthen links, it has also been practice to co-opt a member of AsPEN as an associate member of the commission.
- **LAPEN:** Commission members from Latin America took the lead role in the creation of the Latin-American Physics Education Network (LAPEN), taking inspiration from similar networks throughout the world. The main objective was to coordinate projects and to establish links between existing groups working on Physics Education in different countries of the region. LAPEN today is a vibrant network that regularly organizes workshops, conferences and also brings out an online journal twice a year. To further strengthen the bonds with LAPEN and physics education in the region, ICPE will organize international conferences in Mexico in 2011.
- **ESERA:** The European Science Education Research Association (ESERA), although not specially established for physics, is very active and organizes conferences on a regular basis. Better coordination is required to avoid overlap of events to the detriment of interested participants.
- **IUPAP Working Group on Women in Physics:** This Working Group was formed by resolution at the IUPAP General Assembly at Atlanta in 1999 in response to the felt need for increasing the participation of women in physics. Since then, three IUPAP sponsored International Conferences on Women in Physics have been held at Paris 2002, Rio de Janeiro 2005 and Seoul 2008. ICPE has been a strong proponent of the resolutions emanating from these conferences which have all been formally adopted by IUPAP. ICPE conferences ensure inclusion of women in programme committees, among invited speakers and participants. Organizers are also encouraged to devote a session on issue of gender equity and physics education pedagogies and curricula that help retention of women students in physics.
- **IUPAP Commission 13:** Established in 1981, Commission on Physics for Development came into being to promote the exchange of information and views among the members of the international community of physicists in the general field of physics for development. The mandate is to help in appropriate ways the improvement of conditions of physics and physicists in developing countries; to propose and if appropriate, support initiatives to contribution of physics to industrial development; and to collect and distribute relevant information on opportunities for Physics Development. In the galaxy of physics domain based commissions of IUPAP, C13 and C14 being general commissions are the two

thematic exceptions. However, seen as crucial to growth of physics, both are especially supported in many ways. An ICPE commission member is a liaison member to C13 annual meetings. This synergy has been particularly useful in understanding the needs of developing countries.

### **World Conference on Physics and Sustainable Development**

As part of the International Year of Physics (IYP) celebrations, IUPAP, UNESCO, The Abdus Salam International Centre for Theoretical Physics (ICTP) and the South African Institute of Physics (SAIP) came together to organize the unique World Conference on *Physics and Sustainable Development (WCPSD)* from 30 October to 2 November 2005, at Durban, South Africa. This conference was different as it was visualized as the starting point of a long term world-wide initiative. The organizers identified that if physics is to impact sustainable development, there is need to understand and suggest action plans for the coming years in four critical areas, namely, Physics Education, Physics and Economic Development, Energy and Environment, and Physics and Health. Pratibha Jolly as Chair of ICPE and Priscilla Laws were invited to co-chair the physics education segment. The Secretary of ICPE, Dean Zollman, joined the efforts as a key member of the Planning Committee that also included the UNESCO representative Minella Alarcon, Program Officer in charge of Basic Sciences at UNESCO and Associate Member of ICPE. Judy Franz, Secretary General of IUPAP and key motivator of WCPSD played a proactive role in shaping the segment.

***Physics Education Goals:*** One of the major concerns was to involve those in developing countries and help strengthen physics education in culturally relevant ways, determined and sustained by local initiatives. The Planning Group identified through its own network potential participants, especially from the developing countries. This stakeholder group joined an electronic forum to exchange views on the specific issues to address, themes for invited talks and breakout discussion for action planning. Vibrant discussions led to identification of guidelines for action planning. It was decided to limit focus to the improvement of physics education at the secondary level as well as at the university level for future physics teachers in both primary and secondary schools. Further, it was decided to set up working groups at the conference to identify the common denominator of problems and suggest how best to promote basic physics teaching that is enhanced by the use of locally developed examples, assignments and projects that are familiar to teachers and their students.

***WCPSD Action Plans:*** The WCPSD concluded with the formulation of specific action plans:

1. To give educators and students in developing countries access to high quality physics education resources by establishing a website and Physics Education Resource Centres in Africa, Asia and Latin America.
2. To develop supplemental instructional materials for secondary physics courses that help students understand how the mastery of physics concepts can enable them to contribute to sustainable development in their own countries.
3. To develop model workshops for teacher-trainers in Asia, Latin America and Africa that exemplify how active learning methods can be adapted to help meet the needs of students in developing countries.
4. To establish a structured multi-disciplinary mobile science community that provides support to mobile science practitioners, enabled by a web and internet site at [www.mobilescience.info](http://www.mobilescience.info) hosted by the Institute of Physics (UK).

There was a sense of gratification as the conference had succeeded in creating a fairly inclusive stakeholder network. Feedback showed the Physics Education segment to be most participative



and immensely successful. There was also trepidation as the task assigned was daunting in challenge. The IUPAP endorsed these action plans at the meeting of its Council Chairs and Executive Council held at Institute of Physics, London in February 2006. The planning Group was given the mandate of implementing the WCPSD action plans 1 to 3. Institute of Physics, UK, took charge of implementing the last recommendation.

### **IUPAP Resolution on Active Learning and Hands-on Education**

In furtherance of its commitment to the WCPSD action plans, IUPAP constituted a committee that included the Chair of ICPE to draft a resolution on importance of active learning, hands on education and laboratory work. This resolution was unanimously adopted at the 26<sup>th</sup> General Assembly held in Tsukuba, Japan, in October 2008. It states that:

The International Union for Pure and Applied Physics (IUPAP) urges that National Governments, Physical Societies, Funding agencies, Physicists, and Physics educators in all countries

- support best practice of physics education and physics education research at all levels by encouraging teaching methods, including laboratory work, that actively engage the hands and minds of learners.
- make available funds for establishment of well equipped laboratories and designing appropriate curricula that lay particular emphasis on teaching the skills of the experimenter.
- support indigenous development of low-cost instruments, physics apparatus and equipment, and — when finances allow it — computer-based data-acquisition systems for real-time measurements at the appropriate level of sophistication for a variety of uses in teaching of physics in the classroom and the laboratory.
- support curricula that teach physics with an appropriate diversity of methods, including hands-on approaches, that encourage critical thinking and help students understand how physics is relevant to their local cultures and to a sustainable future for humankind.

To help give effect to the resolution, the General Assembly also supported the suggestion of its International Commission on Physics Education that

- special sessions be organized on educational aspects of hands-on learning, experimentation, and appropriate assessment, in discipline specific conferences of the IUPAP commissions.
- multinational collaborations and workshops be organized for design and development of resource material for active learning and laboratory work; and further, dissemination through professional training of physics educators.
- electronic resource centres be established for exchange of ideas about local initiatives, teaching materials, prototypes of “hands-on” equipment, in particular those that can be locally adapted for construction by the teachers and their students, to serve a variety of educational needs in diverse cultural contexts.

The adoption of this resolution is a milestone that recognizes the importance of adopting best practice in physics education and reiterates the urgent need to give a boost to physics education if research in physics is to thrive. In tune with the changes it has identified, the commission has on its future agenda activities that would provide, on one end support to school teachers, and the other, bridge the gap between the researcher in physics education and the physics specialist. To this end, an important suggestion that ICPE made was that all IUPAP Commissions should have on agenda Physics Education issues in their forthcoming conferences and discuss how the Commission specialities could be taught in schools and universities. In these deliberations, it was suggested that researchers in Physics Education could also be invited to present their way

of thinking and their work in context. It also made a plea for exploring the implications on teaching of the growing interdisciplinary nature of physics and the changing profile of the physics student. These concerns could also be taken serious note of by the teaching community and professional bodies in member countries.

### **Promoting Active Learning**

A concerted effort has been made to implement the WCPSD Action Plans by all the sponsoring organizations and key players. Workshops to promote Active Learning have been on top of the agenda.

**ALOP Workshops:** Within the framework of the UNESCO program for basic sciences, an international team of resource persons, led by Minella Alarcon, Program Officer in charge of Basic Sciences at UNESCO, has with increasing frequency organized numerous workshops on Active Learning in Optics and Photonics (ALOP) in various developing countries such as Tunisia (March 2005); Morocco (Cadi Ayyad University, Marrakech, April 2006); India (Miranda House, University of Delhi, November 2006); Tanzania (Dar Es Salaam University, July 2007); Brazil (Universidade de São Paulo, July 2007); Mexico (Leon Guanajuato, November 2007); Argentina (2008); Mozambique (2008), and many more. The week long workshops designed for teacher trainers from developing countries on a single topic area with capstone applications – in this case, atmospheric physics and photonics – use active learning materials with low-cost equipment. A training manual has been developed. The material is well structured. The manual has been translated in other languages to wide outreach. The end-of-unit topics motivate teachers and their students to learn basic physics in order to understand new areas of science and technology that are highly valued in the global economy. These workshops serve as a paradigm for efforts to promote the educational goals set by participants at WCPSD throughout the world [14].

**The PHYSWARE Workshop series:** As a direct follow-up to the WCPSD mandate, Co-Chairs Pratibha Jolly (India), Priscilla Laws (US) along with commission members Dean Zollman (US) and Elena Sassi (Italy) proposed the idea of organizing a series of Educate the Educator workshops to improve the quality of teaching at the tertiary level. Thus came into being *Physware: A collaborative workshop on low-cost equipment and appropriate technologies that promote undergraduate-level, hands on physics education throughout the developing world*. As *Physware* promises to be amongst the most important activities of ICPE in the coming years, the workshop is described in some detail.

The first *Physware* was held at ICTP, Trieste, from 16 to 27 February 2009 with above listed four as co-directors and Joseph Niemela from ICTP as local co-ordinator and facilitator. For obvious reasons, teaching of Newtonian Mechanics was chosen as the theme for the first workshop. In addition to the ICTP publicity network, a concerted attempt was made by the directors to outreach physics education communities by distributing the workshop poster at several physics education events across the world, posting it on pertinent websites and newsletters such as that of the Commission. A record number of more than 200 applications from 48 countries were received, posing a challenge to selection. Rigorous scrutiny enabled selection of 32 participants from 27 countries spread across Africa, Asia, Latin America and Europe. The participants represented a multicultural but eclectic group of extremely talented and innovative physics teachers, teacher-trainers and administrators – some bearing multiple responsibilities – with demonstrated potential for assuming leadership role in dissemination activities and organization of similar workshops.

The two week workshop (with 10 working days) was structured to have four blocks of one hour forty five minutes on each day. Additionally, seven days included a two hour post dinner block to accommodate poster sessions and special discussions. The participants were given an exposure to physics education research based concept tests, diagnostic tools and learning cycles that promote active engagement in the context of teaching-learning of kinematics and dynamics. The first week activities, focused on laboratory work and class activities based on using no-cost and locally available low-cost materials, witnessed development of several innovative measurement set ups and procedures. For instance, different length pendulums were used as clocks to measure time in arbitrary units and mahogany flower pendulum was used to study damping. Later the ubiquitous cell phone provided a convenient mechanism for accurate measurement of time. In the second week, the participants were given a rigorous exposure to appropriate technologies and computer-based measurement using motion sensor, force sensor and photogates. Powerful video capture and data analysis tools were used to analyze video clips of interesting motions such as that of a basketball thrown by a player in action. A session was also devoted to how simulations can be integrated into a learning cycle to enhance conceptual learning.

The touchstone of *Physware* was collaborative work on projects. This generated a vibrant atmosphere simulating an effective active learning environment that can be replicated for students. As an illustrative example, one of the projects evaluated effectiveness of two different technologies, use of video capture and timing devices, to measure the time of free fall. Some of this work was refined later for publication.

Evening discussion sessions spanned a wide range of topics. For instance, the issue of under representation of women in physics was discussed. Participants shared informal statistics, country reports, personal experiences and successful initiatives to reverse the trend. Issues of multicultural and multiethnic classroom followed its natural extension. Another highlight was creation of a *Physware* Discussion Group and a Blog. This was in addition to the *Physware* Workshop site at the ICTP portal and the Wiki created by the directors. The participants were quick on uptake and throughout the workshop used the sites for exchange of information, resources and discussion on several threads.

An important development was that Director ICTP K Sreenivasan remained proactively tuned in and spent a lot of time interacting with the participants, formally and informally. He listened carefully to the problems of physics education in developing countries and the need for ICTP to initiate programs in the area. The participants functioned well as an advocacy group and urged ICTP to continue support to *Physware* and further, facilitate a web-based system that would enable the formation of a *Physware* community of practice. This was seen as a critical requirement for participants to continue the collaboration forged at the workshop while working in their respective countries.

The workshop successfully established a primary network of outstanding physics teachers from developing countries who have an overview of validated best practices in physics education. These educators expressed enthusiasm about sharing their knowledge of active learning using low-cost materials and emerging technologies and finding solutions to regional and local physics education problems. Since then, several participants have taken a lead role in organizing active learning workshops in their region.

It was felt that the initiative can be sustained and impact physics education only if it is institutionalized. ICPE was seen as the appropriate stakeholder to take the lead role. In October

2009, the President of IUPAP – acting on behalf of ICPE – and the Director of ICTP signed a Memorandum of Understanding for a five year action plan. Under this, five annual *Physware* workshops will be organized, with a developing country and ICTP Trieste alternating as venues. Further, ICTP will maintain a website to facilitate formation of a *Physware Community of Practice* to strengthen local and regional outreach of participants. This will also be a unique resource site for physics educators. Subsequently, the commission at its meeting suggested that future ICPE Conferences could dovetail suitably designed active learning workshops of duration ranging from three days to one week, taking advantage of the resource expertise at conferences.

## **FUTURE**

It is well recognized that problems in education run deep. Solutions have to be in consonance with national policies and identified needs. Change is embedded in socio-political and cultural contexts. Given the diversity of educational systems even within a single country, given the enormity of scale, building a global community of practice and mainstreaming innovation is an uphill task. Frequently questions are raised on how international the international cooperation is. Yet, it is indeed possible to identify the common denominator of global concerns on physics education that mandate international linkages, creation of advocacy and action networks, and collaborative projects for promulgation of best practices tuned to regional and local needs. As more and more developing countries emerge from relative isolation, in an increasingly interconnected world powered by social media and advanced communication technologies, there will be paradigmatic shifts in how physics will be taught to the coming generations. New directions of research into how students learn and how they are best taught will open. Creating a critical mass of educators who can keep abreast with rapid change and contribute innovatively will be the foremost challenge. All this will require redefining the idea of a conference and laying greater emphasis on capacity building programs in interactive mode.

As ICPE celebrates a journey of fifty years, it is with collective pride that we note how far we have come. ICPE has faced many challenges and converted them into opportunities. The French hosts have graciously dedicated the last session of the conference on 27 August to celebrating the 50<sup>th</sup> anniversary of ICPE, springing ceremoniously a surprise cake. The effervescence of champagne at Reims still with us, we now look forward to raising many a toast in the coming decades as we set new milestones for ourselves and create an ever increasing circle of collaborators and international friends to achieve our goals. And set new benchmarks for our mission accomplishment.

## **REFERENCES**

1. IUPAP Website: [www.iupap.org](http://www.iupap.org)
2. William C. Kelly, *Witness at Creation: ICPE's Founding and Early Years*,
3. A.P. French, *A Short History of the Commission*, Contemporary Physics 21 (4), 331-344, 1980.
4. P. Jolly, ICPE 2005 Report, *World View on Physics: Focusing on Change*, ICPE Newsletter, No. 51, April 2006.
5. A. P. J. Kalam, *Injecting Beauty of Science in Teaching*, ICPE Newsletter, No. 50, October 2005.

6. W. C. Kelly, editor, *A Survey of the Teaching of Physics at Universities*, (UNESCO) 1966
7. J. L. Lewis, editor, *Teaching School Physics*, (Penguin Books for UNESCO) 1970
8. E. Nagy, editor, *New Trends in Physics Teaching*, Vol. II, (UNESCO) 1970
9. J. L. Lewis, G. Delacote and J. Jardine, editors, *New Trends in Physics Teaching*, Vol. III (UNESCO) 1976.
10. E. J. Wenham, editor, *New Trends in Physics Teaching*, Vol. IV, (UNESCO) 1984.
11. A. P. French, editor, *Einstein: A Centenary Volume* (London: Heinemann Educational Books, 1979; Harvard University Press, Cambridge, MA, 1979).
12. A. P. French and P. J. Kennedy, editors (Harvard University Press, Cambridge. MA) 1985
13. ICPE Website: <http://web.phys.ksu.edu/>
14. Alarcon, M., Arthurs, E., Ben Lakhdar, Z., Culaba, I., Lakshminarayanan, V., Maquiling, J., Mazzolini, A., Niemela, J., Sokoloff, D., "Active Learning in Optics and Photonics: Experiences in Africa," ETO P040, Proceedings of the 2005 ETOP Conference, 161/416 – 163/416 (2005).

# **MECHANICS MULTIMEDIA REVIEWS -Report and recommendations on available multimedia material**

**Raimund Girwidz (Ludwig-Maximilians-University Munich) & Bruce Mason (University of Oklahoma)**

## **Abstract**

Since 2002 an international working group from the MPTL association (Multimedia in Physics Teaching and Learning) has evaluated multimedia websites. Every year the focus is laid on another branch of Physics. Every six years a new round starts. This talk is about this year's review on Mechanics multimedia sites. Areas of interest are new trends, the resources as such, and also to give best practice examples how to apply multimedia. So, the outcome of the review process has two merits. First, there are recommended websites that can enrich lectures on Physics. Second, methods and best practice examples are collected, showing how to use multimedia for learning. Some characteristics will be specified and related to theories of multimedia learning.

## **1 Introduction**

MPTL is the abbreviation of "Multimedia in Physics Teaching and Learning" and stands for a conference group that deals with the challenges posed by the use of new multimedia learning tools. Since 2002 an international MPTL working group has evaluated multimedia sites. Every year the focus is laid on another branch of Physics. Every six years a second round gets its turn. Summaries of the annual reports are available at the website: [www.mptl.eu](http://www.mptl.eu). This year's review is about Mechanics, for a second time. The first part of this paper describes the review process and the results. Of interest are new trends, the resources itself, and also to give best practice examples how to apply multimedia.

Multimedia is a tool (among others) to promote learning. However, there are many factors that can become relevant. In order to extend our knowledge about the learning with multimedia it makes sense to characterize special benefits and to have best practice examples that can illustrate how theoretical considerations can be applied. The second part of this paper is to support the latter objective.

## **2 The review process**

A link list of websites was collected by Bruce Mason (University of Oklahoma) and students. Especially included in the review process were the MPTL-list from 2004, a list from MERLOT, the ComPADRE Digital Library, Didattica, Multimedia Physik and Web Searches. About 180 web sites were found, with an average of 8 to 10 learning objects each. A preliminary screening considered the use of media and the topic. Only non-commercial material was reviewed. On one hand, this is a limitation to sometimes not so polished programming techniques. On the other hand, teachers and students can use the material for free. This goes in line with the idea of open education is accompanied by the possibility for using the material for free. Furthermore, this is an interesting resource of new ideas from mostly academic stuff about how to present Physics.

Finally 84 web sites were reviewed. The collection and the electronic review process were hosted on the Physical Science Resource Center (PSRC).

The evaluation focused on different fields and aspects (see Tab.1). Each item was assessed on a Likert-scale with 5 grades and, as need ed, a free-text review response. Finally a summarizing assessment was given.

Table 1: Items of the rating sheet.

<b>Motivation</b>	<b>User-friend- liness</b>	Is it easy to start using the MM?
		Are the design comprehensible and the image quality satisfactory?
		Is the function of control elements evident?
		Are the software requirements clear and of adequate proportion?
	<b>Attractiveness:</b>	Is the layout appealing?
		Is there a motivating introduction?
		Are there interactive components?
		Is the topic interesting (reference to everyday life, applications, explaining a phenomenon)?
	<b>Clear description of purpose and work assignment</b>	Is the MM up-to-date / innovative?
		Is the intention of the MM evident?
Does the user know what is expected from him?		
Is there a problem to solve or a context to understand?		

<b>Content</b>	<b>Relevance</b>	Is the topic important?
		Does it make sense to use the MM (e.g. problems in understanding, dynamic process)?
	<b>Scope</b>	Is there a profoundness of content?
		Is there a broadness of content (special case, general overview)?
	<b>Correctness</b>	Is the content of the MM correct?
Are simplifications indicated?		

<b>Method</b>	<b>Flexibility</b>	Is the MM appropriate for a broad target group (incl. self-learning)?
		Is it possible to use the MM in different teaching and learning sit.?
		Does the MM allow for the same topic to be approached in different ways?
	<b>Matching to target group</b>	Is a reasonable didactical reduction implemented?
		Are technical terms explained?
		Are the objectives appropriate?
	<b>Realization</b>	Is the general approach suitable to present the subject and realize aims of the given MM?
		Is the type of MM chosen reasonable (video, simul., animation)?
	<b>Documen- tation</b>	Is the operation obvious or explained?
		Is the material self-evident or explained by additional text?
		Is there a reference to material for further studies?
		Any suggestions for implementation into teaching process?

The first part focuses on the aspects "user-friendliness", "attractiveness", and "clear description of purpose and work assignment". The second part looks at the content, with the

subcategories "relevance", "scope", and "correctness". The third part is about the methods, with the aspects "flexibility", "matching to target group", "realization" and "documentation". The reviewers were mainly the colleagues of the international advisory board of MPTL (see [www.mptl.eu](http://www.mptl.eu)).

The second evaluation, the MERLOT (Multimedia Educational Resource for Learning and Online) peer review used similar criteria, although they were not summarized under the same headlines. The categories are named: "Quality", "Potential Learning Impact", and "Ease of Use".

There were only little differences between both groups of reviewers about the highly recommended sites. Those sites which were highly ranked from both groups will be presented here.

### 3. Results

At first, some general remarks are listed, to sketch the variety of materials.

- a) Most of the material is about standard topics of Mechanics (e. g. kinematics, dynamics, harmonic oscillators).
- b) A few sites offer a complete program for Mechanics, based on lectures. Most of them are still widely text based (html-text books).
- c) On the other hand there are more or less isolated simulations, interactive tutorials, video clips and virtual labs. They use new ideas for teaching, however, they are deal with isolated topics, and not yet embedded into a comprehensive learning environment.
- d) There are some sites dealing with special topics like baseball. This sites use Physics to explain the theoretical background of the topics. However a systematic learning of Physics is not the main interest of these authors.
- e) There is no general standard for the design of websites. – We have to live with individual styles and user interfaces.
- f) Just like in the report from 2004, we have to state that only a few sites offer suggestions on how to implement the material in teaching and learning processes.
- g) Concerning trends, a new shooting star is video. However, video collections do not yet belong to the highest ranked sites. Also here in most cases an embedding into an adequate learning environment is not performed. (Some of the new features for learning will be discussed in chapter 4).
- h) To deal with the variety and to administrate the widely distributed material, special search engines are needed, offering also individual administration tools, to collect, combine and supplement the material for teaching. (One option is: <http://www.compadre.org/psrc/>.)

### Recommended resources

(See also the summary from B. Mason on [www.mptl.eu](http://www.mptl.eu).)

The following resources received excellent ratings from both reviews. The first two of these resources received top reviews in 2004 as well.

#### Introduction to Chaos and Nonlinear Dynamics:

T. Kanamaru, Kogakuin University, and J. M. T. Thompson, Cambridge University.

<http://brain.cc.kogakuin.ac.jp/~kanamaru/Chaos/e/>

This web site contains a wide range of simulations of non-linear systems, including applications of Chaos theory to model operation of the brain. The simulations are very professional and they include descriptions of the systems that are studied. There are also images and videos of non-linear systems with many links to other pages on chaos theory. This



material is suitable for university students. It would be improved by having more teaching examples and problems for students.

### **The Pendulum Lab:**

F.-J. Elmer, University of Basel.

<http://www.elmer.unibas.ch/pendulum/index.html>

The Pendulum lab by Franz-Josef Elmer is an extremely thorough investigation of the dynamics of a pendulum. It covers the topic from the simple pendulum to the chaotic motion of the damped, and a driven pendulum. It includes simulations, reference text, and exercises for the student. Virtual experiments can be performed with background information provided by an extensive set of hyperlinked notes that explains the theory of the system. This material can be used for a wide range of student levels, although much of the material is best suited for advanced undergraduate and graduate students.

### **PhET - Motion:**

PhET Research Group, University of Colorado, Boulder.

<http://phet.colorado.edu/en/simulations/category/physics/motion>

The PhET resources were recommended in last year's review of Optics and Waves, and the same comments are appropriate for the materials in Mechanics. The PhET simulations are strongly grounded in research on how students interact with and learn from multimedia. These simulations are designed to create a realistic virtual environment that encourages learners to interact and explore. There is only very basic guidance on how to operate the simulations to encourage student-driven exploration. The physics topics and potential learning goals for each simulation are listed and many simulations include examples of learning activities, clicker questions, and virtual labs. A new feature is a rating scheme for these teaching examples. There are 17 different simulations in mechanics covering topics from kinematics and graphing to energy conservation and torque. One drawback of these resources is that there are no indications of the physical models being used for these simulations or definitions of terms.

### **Open Source Physics:**

Presented by W. Christian & F. Esquembre

The OSP Collection provides curriculum resources that engage students in physics, computation, and computer modeling. Computational physics and computer modeling provide students with new ways to understand, describe, explain, and predict physical phenomena.

On the one hand OSP can bring you back to the roots of modeling Physics by writing a computer program in Java. But with a fantastic library of routines and especially by the ejs-environment it is made easy to produce attractive applications.

On the other hand there are already a lot of attractive applications also with explanations and remarks how to use the material in lessons. And, according to the open source concept, there is always the possibility to see the theoretical background and to adapt a program if needed.

The next materials mostly received very good ratings from reviewers, although for some there was some disagreement between the MERLOT and EUPEN reviewers. These resources can be grouped into two different categories: a) Multimedia-Enabled Tutorials, b) General Resource Collections.

### **a) Multimedia-Enabled Tutorials:**

#### **Contextual Physics:**

Department of Physics, Chinese University of Hong Kong

[http://resources.edb.gov.hk/cphysics/main/main\\_e.html](http://resources.edb.gov.hk/cphysics/main/main_e.html)

The site has two tutorials motivated by real-world questions and activities to explain them. The launching of a rocket is used to introduce concepts of force and Newton's Laws, and highway crash barriers are used to introduce concepts of energy and energy conversion. The tutorials use student activities, videos, flash animations and text explanations. These materials have an emphasis on contextual learning for high school students. The quality of the videos could be higher. There are also restricted materials available to registered teachers that could not be reviewed.

### **Aeronautics Resources:**

NASA Glenn Research Center

<http://www.grc.nasa.gov/WWW/K-12/aerores.htm>

This web site offers a lot of tutorials about physics applications connected to aeronautics and aerospace research. This includes a Beginner's Guide to Aerodynamics, a Beginner's Guide to Propulsion, a Beginner's Guide to Wind Tunnels, and other topics. The breadth and depth of the material is outstanding. The range goes from basic information about operation of airplanes to interactive simulations of fluid dynamics. The site offers illustrations and activities for students of different grades. This is a comprehensive learning resource on aeronautics. The only potential drawbacks of this site is the navigation system, because you can quickly slip from introductory to very challenging material, and there are some of the applets and pages that look a little bit dated.

### **Physics Classroom:**

Tom Henderson, Glenbrook South High School

<http://www.physicsclassroom.com>

This is an extensive tutorial website covering most topics in introductory physics. The tutorial material is easy to read and use. The available multimedia includes animations, shockwave simulations and student explorations, audio-enabled problem solving, and interactive quizzes. All of the materials are organized in a very clear format. This web site will be useful for physical science classes as well as a supplement to trig.-based physics classes because of the emphasis on conceptual understanding.

### **Web-Based Pre-lectures:**

Illinois Physics Education Research Group

<http://research.physics.illinois.edu/PER/prelectures.html>

HippoCampus: Monterey Institute for Technology and Education

<http://www.hippocampus.org/Physics>

These are two very similar resources using quality Flash media as pre-lecture resources for introductory physics classes. The basic goal of this work is to provide new approaches, in addition to textbook reading, to help students prepare for classes. The topics from the course are broken into 5 or 10 minute presentations available for the students to use as needed. Questions are included in the presentations for the students to judge their understanding. These web sites are not particularly interactive or student-centered, but they can provide important background information.

### **b) General Resource Collections:**

In past reviews several broad resource collections of interactive learning objects have been highly recommended. Three of these were also recommended this year, although not as highly as in the past. It seems that there is a tendency, among reviewers and users, to prefer learning environments that contain a full program (from general information and background, over hard core Physics to high tech applications).

**NTNUJAVA Virtual Physics Laboratory:**

Fu-Kwun Hwang, National Taiwan Normal University

<http://www.phy.ntnu.edu.tw/ntnujava/>

This is an extensive web collection of interactive java simulations, each available with a short explanation and description of the physics background. This site has a unique bulletin board interface to encourage comments and suggestions from users.

**Java Applets on Physics:**

Walter Fendt

<http://www.walter-fendt.de/ph14e/>

This applet collection includes about 20 resources on topics in mechanics. Each applet includes controls to change all of the physical parameters in a system. Each of them is part of a web page with a clear explanation of the operation and physics of the applet.

**Dynamical Systems JAVA Applets:**

Robert Devaney, Boston University

<http://math.bu.edu/DYSYS/applets/>

This collection of applets was created to support courses on chaos, fractals, and non-linear systems. These are designed to supplement a series of textbooks with learning activities on dynamical systems. The applets are aimed at grades 7 – 12 and include activities to engage the students in exploration.

**4. Special features and perspectives for learning**

Illustrated by best practice examples from the reviewed sites, we will now look at theoretical consideration about multimedia learning and connect to some findings from psychology of learning.

Definitely, multimedia is only one tool to promote learning and there are much more factors that can become relevant. Thus, it makes sense to focus on the most relevant aspects that characterize the strength of multimedia learning. According to Weidenmann (2002), multicoding, interactivity, and multimodality describe special features of information and communication structures. They open up new ways for teaching and learning, and the terms will now be illustrated by examples.

A) Multicoding means to use different kinds of representations – in this example, different methods for describing motions (see fig. 1 and fig. 2).

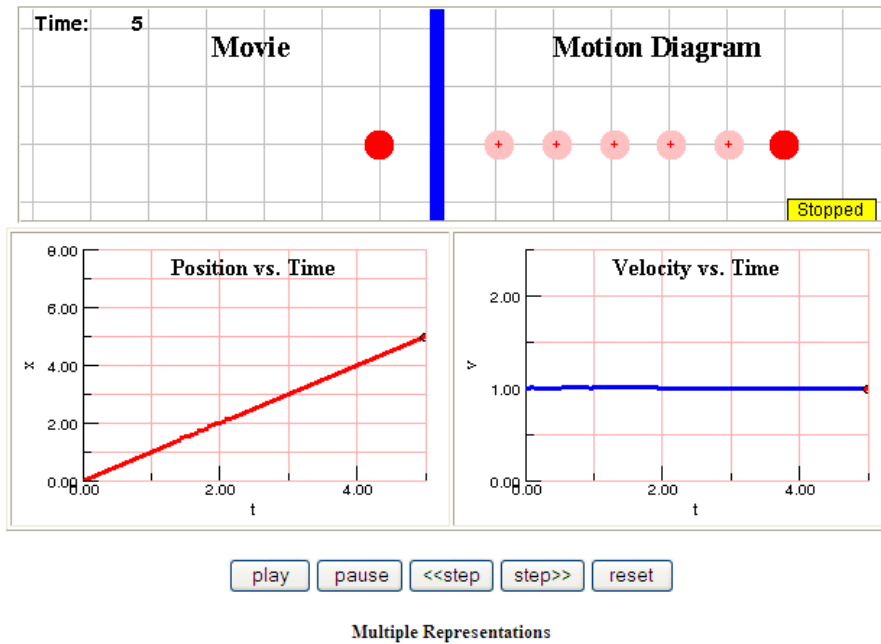


Fig. 1: Different ways to describe the same motion  
[http://buphy.bu.edu/~duffy/semester1/c02\\_multiple.html](http://buphy.bu.edu/~duffy/semester1/c02_multiple.html) (20.8.2010)

Using various forms of representations, that focus on different aspects, can help to improve cognitive flexibility. "Cognitive flexibility" includes the ability to restructure existing knowledge according to the demands of a given situation (Spiro & Jehng, 1990). Thus, a knowledge ensemble can be constructed and tailored to the needs of a problem-solving situation, or to support learning and linking of new concepts (Spiro, Feltovich, Jacobson, & Coulson, 1992). Cognitive flexibility helps to apply knowledge under various conditions in an effective way.

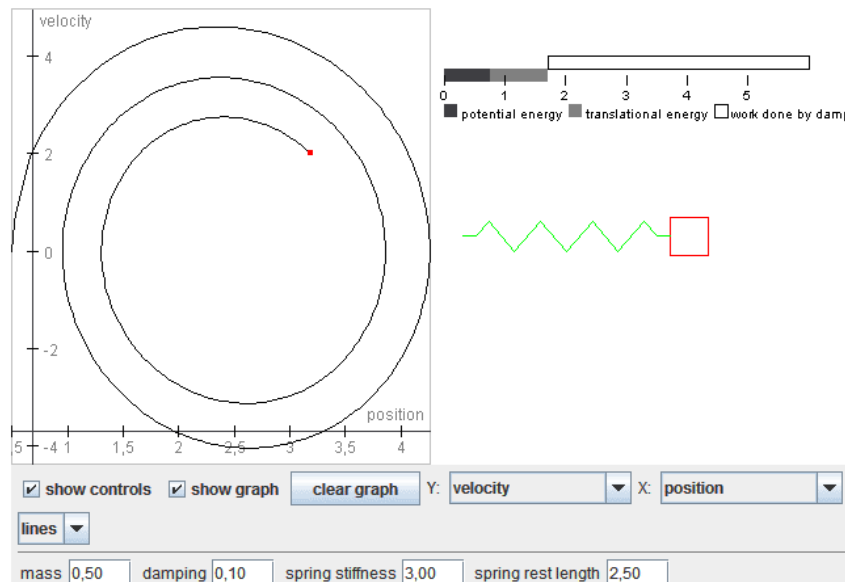
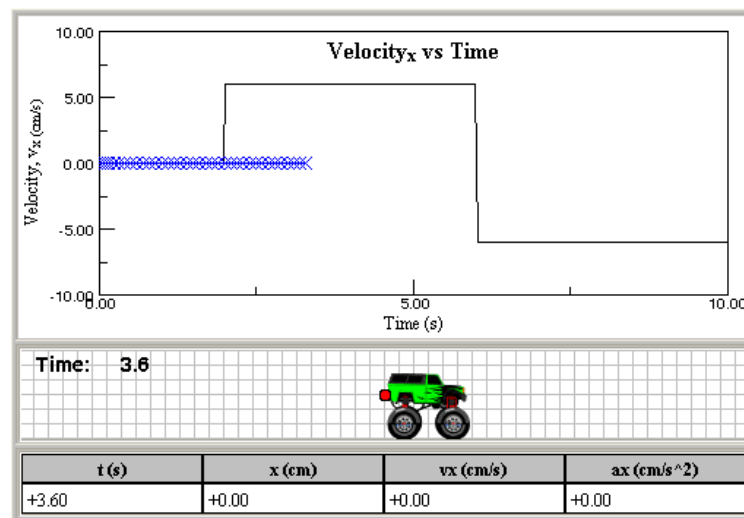


Fig. 2: Different graphical ways to represent the movement of a harmonic oscillator.  
<http://www.myphysicslab.com> (20.8.2010).

B) Interactivity has two main aspects for learning: activation and feedback. Activation calls for the right challenge and an exciting task. In this example one can experience what is shown in the graph. The mouse pointer, respectively the car, has to be moved according to the graph

(see fig. 3). The motion of the mouse is registered and the data can directly be compared with the given graph.

### Match The Velocity Graph



[Start Velocity Matching 1](#)

Fig. 3: This simulation calls for a motion of the car according to the given velocity graph [http://webphysics.davidson.edu/physlet\\_resources/kinematics\\_tutorial/default.htm](http://webphysics.davidson.edu/physlet_resources/kinematics_tutorial/default.htm) (20.8.2010).

Interactive simulations can also give inherent feedback if they are combined with a guiding task. In the next example (see fig. 4) the posed problem is to create standing waves. The right concept is to superpose a wave travelling to the left with one going to the right. If the right settings for the boundaries are chosen and with the right excitation a standing wave is created. The feedback is “success” or “failing”.

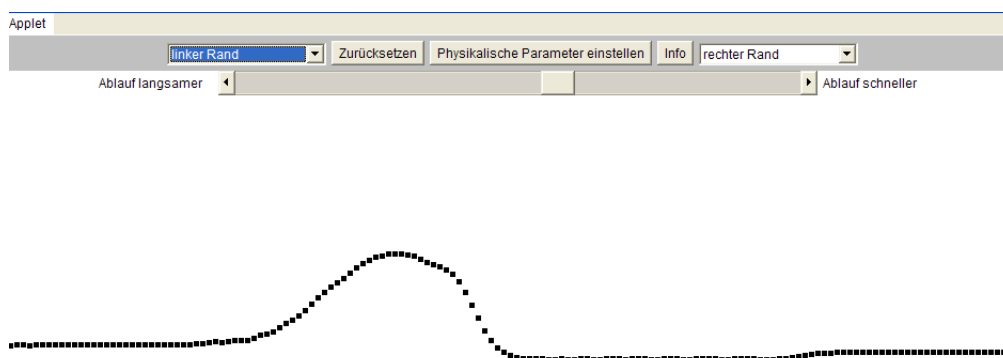


Fig. 4: An interactive wave machine. Excitations are created by mouse movements. [http://www.physikonline.net/spezial/wellen/programm\\_1d/wellenapp\\_jare.html](http://www.physikonline.net/spezial/wellen/programm_1d/wellenapp_jare.html) (20.8.2010).

### C) Multimodality – addressing several input channels.

A multimedia application presenting aural and visual information activates different senses and provides a more realistic and authentic approach. Mayer (1997) described the combined presentation of verbal and visual information as specifically helpful for inexperienced learners. Mayer and Moreno (1998) outlined a split-attention-effect. Better learning results are

possible when verbal and visual information are combined. The arrangement of verbal and visual components may lead to a better processing in the limited working memory (Moreno & Mayer, 1999).

Strictly seen, multicoding, multimodality and interactivity describe superficial characteristics of a user interface. They only set up the general framework and the conditions. For the actual process of learning they can have positive as well as negative effects. For example multicoding can be helpful to open different approaches. On the other hand too many aspects can also be confusing. Therefore further considerations are necessary to specify conditions for learning assistance.

The next sections will present some more examples and specify their potential for particular instructional intentions. At first, video clips are used to support parts of a learning process. Special intentions are: a) Extended visual perception, b) connect abstract concepts to examples from reality, c) assist "cognitive apprenticeship", d) structure knowledge, e) illustrate process oriented explanations, and f) play games with rules that are derived from laws of Physics.

#### **a) Extending visual perception using video or animations**

An interesting idea is to extend our perception and to illustrate what cannot be seen under normal conditions.

At [http://www.physikonline.net/filme/mpg\\_m3\\_scheinkr/foucault13.mpg](http://www.physikonline.net/filme/mpg_m3_scheinkr/foucault13.mpg) a pendulum is filmed with a rotating camera – representing a rotating frame of reference. One can get an impression of what is described by the term "Coriolis Acceleration", respectively "fictitious forces".

Another application is to "take a seat on a basketball" and fly with the ball on a trajectory into the basket.



Fig. 5: Animation to show what could be seen flying along the trajectory of a basketball  
<http://fearofphysics.com/Proj/betheball.html> (20.8.2010).

Streaming video is coming up compared to 2004. Nowadays, video clips are much easier to produce and use. Some reasons for that are the new technologies (non interlaced video), video editor programs that are easy to operate, and free providers for video-sharing websites.

In this multimedia review, with the emphasis on the context of learning, collections of video resources, such as movies or Flash animations, did not tend to receive "Excellent" or "Very Good" ratings. So far, in most cases these sites cover merely isolated topics or do not provide ideally designed learning environments. However, there are many web sites with videos about mechanics that can be used by teachers.

Some of the most notable video collections are:

<a href="http://pen.physik.uni-kl.de/medien/MM_Videos/index_eng.html">http://pen.physik.uni-kl.de/medien/MM_Videos/index_eng.html</a>	High quality video and special topics
<a href="http://livephoto.rit.edu/">http://livephoto.rit.edu/</a>	Focus on video analysis for mechanics
<a href="http://www.iwf.de/iwf/default_en.htm">http://www.iwf.de/iwf/default_en.htm</a>	Large collection on many topics
<a href="http://groups.physics.umn.edu/demo/">http://groups.physics.umn.edu/demo/</a>	Lecture Demonstration videos
<a href="http://www.upscale.utoronto.ca/GeneralInterest/Harrison/Flash/">http://www.upscale.utoronto.ca/GeneralInterest/Harrison/Flash/</a>	Short Flash tutorials and animations
<a href="http://phys23p.sl.psu.edu/phys_anim/mech/index_mech.html">http://phys23p.sl.psu.edu/phys_anim/mech/index_mech.html</a>	Database of Flash animations of physical systems and experiments

(see also the report from B. Mason on [www.mptl.eu](http://www.mptl.eu)).

### b) Connect to real phenomena

Realistic videos can connect abstract considerations from Physics to real phenomena. Realistic scenarios can directly be related to other representations of Physics. An example can be seen in fig. 6, respectively on the referred website. The motion of a harmonic oscillator is described by using different methods. The course of movement is synchronized in different forms, always indicating the relationship between the different kinds of representation.

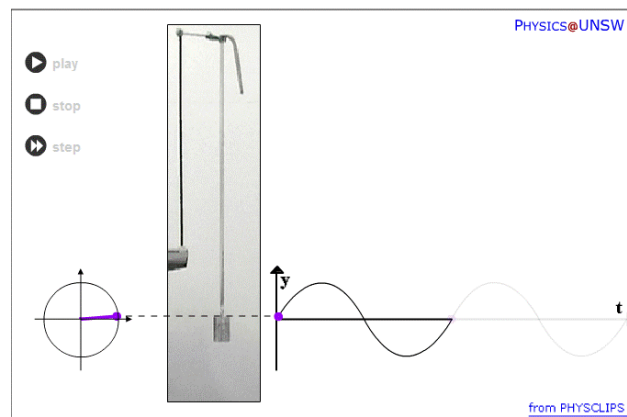


Fig. 6: Combination of realistic and abstract representations of a harmonic oscillation.  
<http://www.animations.physics.unsw.edu.au/jw/SHM.htm#yva> (20.8.2010)

### c) From observation to conceptual understanding.



Fig. 7: A picture out of a video showing effects of perpendicular pokes on a rolling ball  
<http://paer.rutgers.edu/pt3/movies/bowlingball.mov> (20.8.2010)

Video clips can play an important role to guide from observation to conceptual understanding. Steps of well-directed observations can easily be repeated, and additional visual and aural information can help to interpret the phenomena physically. The site from Rutgers (see fig. 7) offers different videos to train observing and describing phenomena. Corresponding methods, following the concept of cognitive apprenticeship, are described.

**d) Structuring Physics - – with concept maps towards a knowledge network**

A structured knowledge base is important for problem solving and should be taught from the beginning. So, "Hyperphysics" has organized information in clickable maps. It makes it easier to organize knowledge in a pictorial representation and to point out connections.

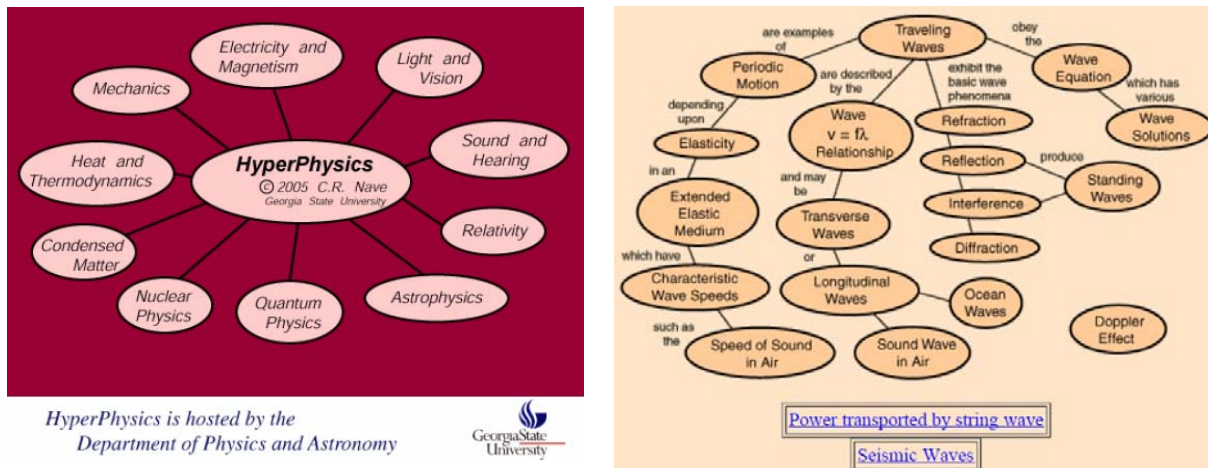


Fig. 8: Maps to illustrate knowledge domains  
<http://hyperphysics.phy-astr.gsu.edu/hbase/hph.html> (20.8.2010)

De Jong & Njoo (1992) emphasized that structuring of knowledge and linking it to prior knowledge are two important components of a learning process. Well structured and properly organized knowledge improves the accessibility and is also important for problem-solving (Reif, 1981). Charts, mind maps and diagrams can illustrate relations, can help to analyze a knowledge domain, and improve recognition of information (Beisser, Jonassen, & Grabowski 1994). From that point of view ("clickable") concept maps are of special interest.

**e) Process oriented explanations with text and animated illustrations**

Animated illustrations can help to understand dynamic processes. Multimedia makes it possible to offer them directly in combinations with written or spoken text. This meets the demands of spatial and temporal contiguity (Mayer, 2002) (see the website from fig. 9).



### The Speed of the Running Surface

Below we show the velocities of points on the running surface of a curling rock **relative to the ice**.

For the torus, the direction of the frictional forces was opposite the direction of these velocities. However, the rotating rock tends to drag the layer of water along with it. The data indicate that the directions of the frictional forces on the rock is opposite the direction of the velocities **relative to the water with which it is in contact**. Thus the direction of the forces in the previous scene are not exactly as shown.

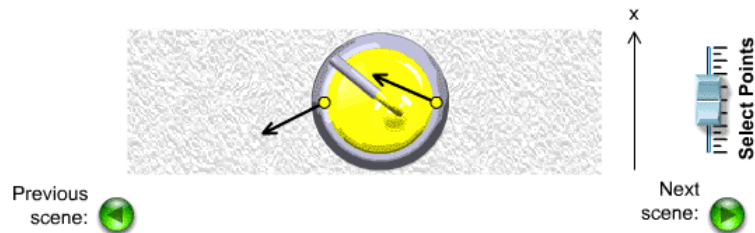


Fig. 9: An internet site with animations and simulations about curling  
<http://faraday.physics.utoronto.ca/GeneralInterest/Harrison/Flash/ClassMechanics/Curling/Curling.html> (20.8.2010)

#### f) Games with rules derived from Physics laws

Laws of Physics wrapped up in rules of a game – this can be a good idea to utilize employ the attractiveness of games to mediate an understanding of consequences that are bonded with these laws. The "Lunar Lander" is a nice application, already known from early years of computer programming. ChabotSpace had an introduction to a lunar lander game with clearly defined rules - the Newton's laws. Only after a presentation of these rules the game started. <http://www.chabotSpace.org/vsc/exhibits/lunarlander/lunarlander.asp> (20.8.2010)

(Remark: Unfortunately this website was rebuilt and the introduction was skipped, and only the game is available. Nevertheless, the described principle is/was a nice idea to offer Physics.)

#### 5. Conclusion

In the internet we can find really good and inspiring material for multimedia learning. Nevertheless we need research and have to train, how to use it in the best way. For that intent best practice examples have a double value: They are tools that can directly be used, and they can put theoretical considerations in concrete terms.

#### References

Beisser, K. L., Jonassen, D. H., & Grabowski, B. L. (1994). Using and selecting graphic techniques to acquire structural knowledge. *Performance Improvement Quarterly*, 7(4), 20-38.

ComPADRE, <http://www.compadre.org> (accessed 8/10/2010)

De Jong, T., & Njoo, M. (1992). Learning and Instruction with Computer Simulations: Learning Processes Involved. In E. De Corte, M. C. Linn, H. Mandl and L. Verschaffel (Eds.), *Computer-Based Learning Environments and Problem Solving* (NATO ASI Series. Series F: Computer and Systems Sciences; 84) (pp. 411-427). Berlin: Springer.

Didattica, <http://www.ba.infn.it/didattica.html> (accessed 8/10/2010)

EUPEN Working Group 3, [http://www.eupen.ugent.be/wg/wg3\\_results\\_multi.php](http://www.eupen.ugent.be/wg/wg3_results_multi.php), accessed January 2010

- Mayer, R. E. (1997). Multimedia learning: are we asking the right question? *Educational Psychologist*, 32, 1-19.
- Mayer, R. E. (2001). *Multimedia learning*. New York, NY, US: Cambridge University Press.
- Mayer, R. E. (2002) *Multimedia Learning*. *The Psychology of Learning and Motivation*, 41, 85-139.
- Mayer, R. E., & Moreno, R. (1998). A split-attention effect in multimedia learning: Evidence for dual processing systems in working memory. *Journal of Educational Psychology*, 90(2), 312-320.
- MERLOT website, <http://www.merlot.org>, (accessed 8/10/2010)
- MERLOT-Physics peer review outline and rubrics, <http://physics.merlot.org/PeerReviewOverview.html> (accessed 8/10/2010)
- Moreno, R., & Mayer, R. E. (1999). Cognitive principles of multimedia learning: The role of modality and contiguity effects. *Journal of Educational Psychology*, 91, 1-11.
- MPTL Reports, *Multimedia in Physics Teaching and Learning (MPTL), Reports & Recommendations*, <http://www.mptl.eu/reports.htm>, accessed January 2010
- Multimedia Physik, <http://www.schulphysik.de/> (accessed 8/10/2010)
- Physical Science Resource Center: <http://www.compadre.org/psrc/> (8/29/2010)
- Reif, F. (1981). Teaching problem solving – A scientific approach. *Physics Teacher*, 19, 310-316.
- Spiro, R. J., & Jehng, J. (1990). Cognitive flexibility and hypertext: Theory and technology for the non-linear and multidimensional traversal of complex subject matter. In D. Nix and R. Spiro (Eds.), *Cognition, Education, and Multimedia*. (pp. 163-205). Hillsdale, NJ: Erlbaum.
- Spiro, R. J., Feltovich, P. J., Jacobson, M. J., & Coulson, R. L. (1992). Cognitive Flexibility, Constructivism, and Hypertext: Random Access Instruction for Advanced Knowledge Acquisition in Ill-Structured Domains. In: T. Duffy and D. Jonassen (Eds.), *Constructivism and the Technology of Instruction: A Conversation*. (57-75). Hillsdale N. J.: Lawrence Erlbaum.
- Weidenmann, B. (2002). Multicodierung und Multimodalität im Lernprozess [Multicoding and Multimodality in Learning Processes]. In L. J. Issing, und P. Klimsa (Hrsg.), *Information und Lernen mit Multimedia*. (S. 45-62) Weinheim: Psychologie Verlagsunion.

# **Stimulating scientific reasoning through explorations of simple experiments**

Gorazd Planinsic, Faculty for Mathematics and Physics, University of Ljubljana, Slovenia

## **Abstract**

Simple experiments with surprising outcomes can stimulate inquiry mind and create desire for learning and knowledge. With carefully posed questions that ask for explanations and predictions and guide students toward additional experimentation and observations, one can create active learning environment in which students step by step build the coherent picture about the physics and develop science related competences. This paper focuses on three elements, spotlighting, staging and context that play important roles in maximizing the benefits from simple experiments. Two examples of simple experiments are presented and analyzed in the light of the three elements.

## **Introduction**

Though there are ongoing debates on how large is the share and importance of experiments in teaching, it is widely accepted that experiments are an essential part of physics education. Traditionally the experiments in physics teaching are divided into demonstration experiments and laboratory experiments but this classification does not communicate their role in learning physics. In this paper we will focus on some important elements that must be considered in order to maximize the learning role of simple experiments. The term ‘simple’ is mainly used to emphasize the simplicity of building and showing the experiment, hoping to encourage teachers to use them in the classroom and students to make them at home. In addition the term ‘simple’ may also indicate (but not necessarily) the contextual richness of the experiment or setting, often meaning that the objects used are from everyday life of the students. Note that ‘simple’ does not refer to the level of knowledge needed to explain the experiment.

Simple experiments have been recognized as important in teaching physics from the very beginning. Sutton writes in his famous book [1]:

“Simplicity (but not crudity) of arrangement and manipulation is paramount. Teachers often avoid simple experiments, favouring those which require elegant and elaborate facilities. ...It might be stated ...that the experimental arrangement should be more easily understood than the concept that it is designated to illuminate.”

## **How to go beyond mere excitement and how to get more understanding from simple experiments?**

Questions like this stimulated group of people (including the author of this paper), from the EPS Physics Education Division, to start project called *More Understanding from Simple Experiments* (MUSE). You can find more about MUSE, including materials that have been developed so far, on the EPS PED webpage [2].

When trying to maximize the learning benefits from simple experiments, there are several elements to consider. Here we will focus on three important elements: spotlighting, staging and context.

### Spotlighting and staging

Terms spotlighting and staging were coined by L Viennot [3]. Spotlighting means focusing on central content features that we want students to learn. Spotlighting requires a thorough content analysis and the “cleaning” of the experiment from distracting elements – but preferably not at the expense of reducing its context richness.

Staging means focusing on how to achieve the best learning outcome with a particular experiment. Successful staging requires knowledge of learners’ common ideas, reasoning and their ability to observe the experiment and to construct its mental representation. Clearly spotlighting and staging are interrelated. In words from Viennot: the “what” and “how” of teaching overlap. Spotlighting stands as an answer to “what” and staging to “how”.

### Context

Perhaps the shortest reflection on this account was given by J. Ogborn [4] “A scientific explanation is a story”. Later he adds “To tell any of the scientific stories successfully it is necessarily to try to excite the imagination”. Often we can do it by placing the examples in appropriate contexts. It is generally accepted that context-based material can engage pupils’ interest. The context in which the knowledge is learned is crucial in promoting the transfer of knowledge, which means, developing the ability to apply knowledge learned in one situation to a new problem or a situation. Therefore it is not surprising that active learning activities are closely linked to context-based materials. The choice of a context has to be tuned with the experiment and with the level of study. As Bennett puts it in her book “*Teaching and Learning Science*” [5]:

“...the interpretation of the term ‘context’ evolves with the level of study from one with a direct relevance to an individual’s immediate life and surroundings, to more sophisticated illustrations of the contribution science and scientists make to society.

...

At the secondary level (age 11 to 19) pupils’ lack of interest in science is often attributed to its remoteness from everyday life. However, at the primary level, it would appear that what makes science attractive to pupils is its difference from everyday life and the use of specialist equipment in specialist location”.

Finally, we should warn against over-contextualization. What one aims is to achieve a balance between specific examples and the general principles.

In the remaining part of the paper we will describe two simple experiments and discuss them in light of staging, spotlighting and context.

## Two examples

### Rubber balloon and Ideal gas law

Obtain an ordinary rubber balloon and a hand held bicycle inflator (see figure 1) that contains a metal cartridge with compressed CO<sub>2</sub>. Measure the initial mass of the bicycle inflator and the air temperature before performing the experiment. Inflate the balloon with the bicycle inflator until the cartridge is empty. Measure the pressure in the balloon using a gas pressure sensor (make sure no gas escapes) and again measure the mass of the bicycle inflator.



**Figure 1.** Equipment needed to perform the experiment (from left to right): bicycle inflator, CO<sub>2</sub> cartridge, balloon, precision scales, gas sensor and thermometer.

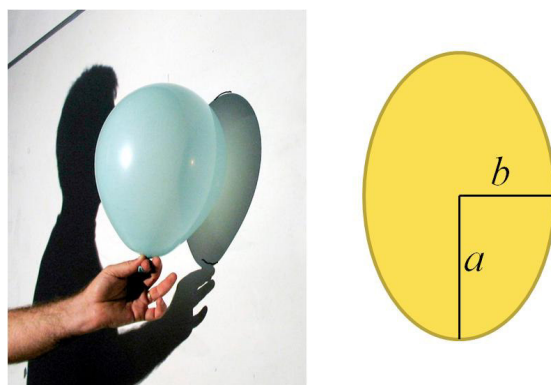
We measured four out of five quantities that appear in the ideal gas law:  $m$ -mass of the gas (difference between the initial and final mass of the inflator),  $p$ -pressure,  $T$ -temperature (we can assume that after several minutes the temperature of the gas in the balloon is equal to the air temperature outside the balloon) and  $M$ -molar mass of the gas (we know the cartridges are filled with CO<sub>2</sub>). Using the ideal gas law we can calculate the missing quantity,  $V_b$ -the volume of the balloon. Typical values of the quantities as measured in one of our experiments and corresponding calculated volume are given in the table 1.

**Table 1.** Typical measured and calculated values for the balloon experiment

$M = 44 \text{ kg/kmol}$
$m = 15.3 \text{ g}$
$p = 102.3 \text{ kPa}$
$T = 298.3 \text{ K}$
$V_b = 8.4 \text{ dm}^3 \text{ (calc.)}$

If we want to convince the students that the ideal gas law correctly describes the relationship between the five quantities we have to measure the volume in independent way and compare the value with the one obtained above. Before doing this, ask students to judge if the result that we obtained makes sense. Does it seem reasonable that the volume of this balloon is 8.4

litres? Students can make visual comparison of the balloon and four 2-litre bottles of beverage. The majority will say that the volume of the balloon looks smaller than the volume of the four bottles. The need for an independent measurement may become a students' idea. Encourage students to propose different ideas how to measure the volume of the balloon. Discuss limitations and accuracy of the suggested methods. A simple method how to estimate the volume of the balloon is shown figure 2.



**Figure 2.** A simple method for determining the volume of the balloon. The contour of the balloon's shadow can be approximated with an ellipse with a major axis  $a$  and a minor axis  $b$ .

Put the balloon next to the whiteboard and aim the light from a distant overhead projector or a slide projector to the balloon. Draw a contour of the balloon's shadow on the whiteboard; remove the balloon and measure the major and minor axes of the ellipse-like shape. You can approximate the balloon with a sphere and take the average of these two numbers, use it as a radius of the sphere and calculate the volume. In a more accurate approximation you can assume that the balloon is a rotational ellipsoid with the volume equal to  $v_b = \frac{4\pi}{3}ab^2$ , where  $a$  and  $b$  are the lengths of the major and minor axes of the ellipsoid. In our case we measured  $a = 15$  cm,  $b = 12$  cm and obtained the volume of the ellipsoid equal to about 9 litres. As you can see, this crude independent measurement gives the result that is in a good agreement with the previous result.

In this case we spotlighted the validity of ideal gas law. It is well known that students have several common difficulties understanding and applying multivariable relationships such as ideal gas law [6,7]. We have tested the law only in one point but if students work in groups each group can test the validity of the equation in a different point (for example by varying the mass of the gas released from the cartridge). Staging of the experiment has been done by choosing to determine the volume of the balloon, which in addition showed how subjective can our judgment be. Note that in many traditional cook-book labs as well as in demonstration experiments the staging of this (and several other experiments) is typically done in the following way: students or teacher determine all variables and then calculates the constant, in our case gas constant  $R$ , which they later compare with "the right value". Since

this constant is given in every textbook to the high precision it is not surprising that students see little or no point in determining its value in such a crude experiment.

Finally note the elements such as using the bicycle inflator and the soda bottles that contextualize the balloon experiment and connect it to students' everyday life. Paying attention to such elements not only increases the motivation but also shows that physics "works" with everyday objects and is therefore useful also in everyday life.

But there is more about this experiment!

After inflating the balloon we can pose the following question. How we can estimate the initial pressure of CO<sub>2</sub> in the cartridge before we emptied it into the balloon? A common answer to this question is to imagine that we slowly (isothermally) compress the gas in the balloon until it reaches the volume of the empty cartridge. Applying Boyle's law one can express the pressure of the gas in the cartridge as  $p_c = p_b \frac{V_b}{V_c}$ , where indices  $b$  refer to the

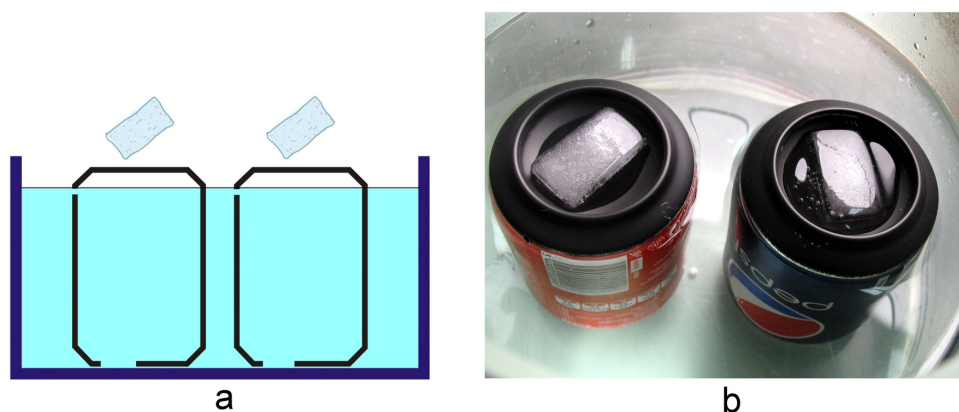
balloon and  $c$  to the cartridge (the volume of the cartridge was assumed to be much smaller than the volume of the balloon). The volume of the cartridge can be measured using a syringe and water. In our case we found  $V_c = 20 \text{ cm}^3$  what gives the result  $p_c = 460 \text{ bar}$ . Students usually don't have experiences with high pressures so they will not be able to judge if this value makes any sense. But we may encourage them to compare this result with the data that they can find from different sources. Eventually they will find on the package of CO<sub>2</sub> cartridges or on web pages of their producers that the typical pressure in the cartridge is about 56 bar, which is almost ten times less than the value calculated in our case. Where did we make a mistake? Math was ok, but the assumption that we could apply the ideal gas law in this situation was wrong. If all gas is compressed into the cartridge then the final density of the CO<sub>2</sub> in the cartridge is equal to  $m/V_c = 0.8 \text{ g/cm}^3$ . Now we see: we tried to apply ideal gas law in situation where the gas density is comparable to the density of water. In such circumstances gas no longer behaves like an ideal gas. Students can learn to recite the definition of the ideal gas but if they seldom challenged to make judgments based on this knowledge then the acquired knowledge is of no value.

In this second part we spotlighted the limitations of ideal gas law. If students only solve numerous end-of-chapter problems that all require application of ideal gas law they get the impression that the ideal gas law can be applied in any situation that deals with gases. The staging of this part was built on creating a conflicting situation. After getting confidence in the validity of ideal gas law we applied it in a simple thought experiment and came to an absurd result. This situation challenges students to search for a mistake and creates the "need to know".

### Soda can and thermal conductivity

For this experiment you will need two empty soda cans (Pepsi and Coke in our case, later you will learn more about them), two equal ice cubes and a container with hot water [8]. The teacher turns two empty soda cans upside down into the hot water. The water is just deep

enough to reach the rim of the can's bottom, as shown in figure 3a. Before dipping the cans into the water the teacher makes a few small holes just above the bottom of each can to allow the air from the cans to leave. Then the teacher places two equal ice cubes on the cans' concave bottoms. The ice cubes start to melt immediately but it is soon evident that ice on the blue can (Pepsi) melts faster than ice on the red can (Coke). Figure 3b shows the situation about half a minute after the ice cubes have been placed on the cans. In our case the water temperature was about 60 °C.



**Figure 3.** a) a sketch of experimental setup. b) the ice cube on the Pepsi can (right) is melting faster than the ice cube on the Coke can (left). The can bottoms are sprayed black only to improve the visibility of the melted ice.

If the experiment were performed as a traditional demonstration experiment, then the teacher would tell students the correct explanation, if necessary she/he would draw sketches and graphs and end up with quantitative analysis. But all this effort will not help the teacher to turn students into active learners. The teacher can do a lot better if she refrains from telling the correct explanation and instead encourages students to gradually construct the correct explanation through guided inquiry. One possible approach here is to use an *Investigative Science Learning Environment (ISLE)* cycle [9]. We briefly summarize the cycle here. Students start with observing a simple experiment (or a series of simple experiments) to identify patterns in the phenomenon. Then they propose multiple explanations of the patterns. After all possible explanations are recorded the students start testing proposed explanations. To do this, they design new experiments whose outcomes they can predict using the above explanations. If the outcome matches the prediction, the explanation is not disproved, if it does not match, the students examine additional assumptions, and if those are found to be valid, the explanation is rejected. The explanations that students failed to reject are used for practical applications.

Let's see how ISLE philosophy can be applied to soda can experiment.

After the students conduct the experiments described above, the teacher encourages students to suggest several possible explanations for the surprising outcome of the observational experiment that is shown in figure 3b. The explanations that most frequently appear in the classroom are shown in the first column in table 2.



**Table 2.** Typical ISLE steps for the “soda cans and ice” experiment. Note that the time line in this table goes from left to right. Note: letter **A** denotes assumptions.

Explanations	Testing experiments	Predictions	Outcomes and judgements
E1. The blue can has thinner bottom than the red can. (A: same material)	Cut the cans and measure the thickness of their bottoms	If E1 => blue can bottom will be thinner	E1 rejected  (E3 also rejected)
E2. The blue can is made from the material with larger thermal conductivity. (A: same thickness)		If E2=> same thickness	
E3. Combination of 1 and 2	Try both cans how they respond to a magnet	If E1 => same response  If E2 and A: one can is ferromagnetic => magnet will stick to that can	Cans are made of different metals.  Red can is ferromagnetic.

After that the teacher asks the students to suggest several testing experiments that will put their explanations to test (second column). For each testing experiment students are asked to make a prediction about its outcome providing that the particular explanation is correct (third column). Based on actual outcomes of testing experiments students finally make judgments about suggested explanations. The outcomes of our testing experiments are shown in figure 4.



**Figure 4.** Thicknesses of the can bottoms are equal (left). A magnet sticks to the Coke can but does not stick to the Pepsi can (note: in some parts of Europe and Asia about half of soda cans are made from steel and other half from aluminium.)

The first testing experiment shows that the bottoms of both cans have the same thickness (about 0.2 mm). The second testing experiment shows that the magnet sticks to the red can but does not stick to the blue can. Based on these data the students can conclude that the cans

are made of different metals, that the red can is made from ferromagnetic material, and that the thicknesses of the cans are the same (fourth column). Based on these results students may propose a new explanation that thermal conductivity of the red can metal is smaller than the thermal conductivity of the blue can metal. In order to test the explanation students may think of new testing experiments but in this case it is better to suggest to them to find more data about what materials are soda cans made of and what thermal properties of these materials are. By searching the Internet students will soon find that in some parts of Europe and Asia about half of the soda cans are made from steel and the rest from aluminium (in USA all soda cans are made from aluminium). In our case the Pepsi can is made from aluminium and the Coke can is made from steel coated with a thin layer of tin. The thermal conductivity of aluminium is about 240 W/mK and that of steel is much lower, between 20 and 40 W/mK. Therefore these data and the testing experiments described above show that the surprised outcome of the initial observation can be accounted to the difference in thermal conductivities of the metals from which the cans are made.

But this is not the end of the learning process. In the final step of the ISLE cycle students are encouraged to think of possible applications of the new knowledge. This application stage may range from planning and designing a new experiment to finding data about applications done by other people. In our case students may try to find answers to the following questions. Why do different countries use different materials to produce cans? What are the advantages and disadvantages of making cans from steel or aluminium? Obviously questions like this offer also opportunities for making cross-curricular connections between physics and other school subjects.

Let's analyze this experiment from the point of view of staging, spotlighting and context. In this case we spotlighted the thermal conduction. There is a subtle but an important advantage of this experiment compared to many traditional experiments related to the same topic. When treating thermal conduction we often forget to stress that the formula  $P = \lambda \frac{S(T_H - T_L)}{d}$  describes the stationary situation meaning that temperatures  $T_H$  and  $T_L$  do not change with time. In the experiment presented here this requirement is fulfilled while in many traditional experiments of this type that often employ metal bars and wax, strictly speaking, this is not true. There are at least two problems with these experiments: 1) For the set-ups that are usually used, the temperature distribution in metal bars does not reach steady state during the whole experiment. 2) Wax does not melt at a particular temperature (like ice) but in a temperature range. The temperature of the waxed end is thus ill defined even after a longer time.

ISLE steps described above provide an excellent framework for staging of this and almost any experiment; it would be hard to add anything more about the staging here. The experiment is also contextually rich. Obviously, soda can is one of the main icons of young people everyday life. In this case a soda can is not used only to catch students' attraction but also to set the stage for creating a whole new story around it.

## References

1. Sutton, R M (1938) *Demonstration experiments in physics*. McGraw-Hill Book Company.
2. <http://education.epsdivisions.org/muse> (retrieved 18.10.2012).
3. Viennot, L (2008) Learning and Conceptual Understanding: beyond Simplistic Ideas, what Have We Learned? (Eds.) M Vicentini, E Sassi, *Connecting Research in Physics Education with Teacher Education*, ICPE (2008), available free at [//web.phys.ksu.edu/icpe/Publications/teach2/Viennot.pdf](http://web.phys.ksu.edu/icpe/Publications/teach2/Viennot.pdf) (retrieved 18.10.2012).
4. Ogborn, J (2008) Science and Commonsense (the same source as in reference 3).
5. Bennett, J (2003) *Teaching and learning science*, London: Continuum.
6. Rozier, S, and L Viennot (1991) Students' reasoning in thermodynamics, *Int. J. Sci. Educ.* 13: 159-170.
7. Loverude, M E, C H Kautz, in P R Heron (2003) Helping students develop an understanding of Archimedes' principle. I Research on student understanding. *Am. J. Phys.* 71: 1178-1187.
8. Planinšič, G (2011) Soda cans aid teaching of thermal conductivity, *Phys. Educ.* 46: 143-145.
9. Etkina, E, in A Van Heuvelen (2007). Investigative science learning environment-a science process approach to learning physics. (Eds.) E F Redish and P J Cooney. Available free at: [www.compadre.org/per/per\\_reviews/media/volume1/isle-2007.pdf](http://www.compadre.org/per/per_reviews/media/volume1/isle-2007.pdf) (retrieved 18.10.2012) AAPT, 2007.

# **The many challenges of Inquiry Based Science Education: Toward multiple learning benefits?**

Laurence Viennot

Given what we know from physics education research, how might we go about maximising the learning benefits of Inquiry Based Science Education (IBSE) in terms of conceptual attainments, whilst keeping its motivational potential? To document this question, a series of examples are presented and discussed. They concern some simple experimental settings that typically constitute a starting point for IBSE activities in physics. They illustrate both some potential obstacles to a fruitful use of inquiry based teaching and some alternatives to ritualistic teaching practices. Such rituals are shown to originate in a teacher tendency to put students' common ways of reasoning in resonance, using what is called here an 'echo-explanation'. In order to overcome the corresponding drawbacks, it is advocated to favour conceptual links in students. This plea relies in particular on the first evaluation conducted on a large recent IBSE project. It is associated with several concluding questions, especially that of how to manage the necessary transitions between teaching mainly relying on IBSE and a more conceptually organized strategy.

## **Introduction**

It has often been argued that using what is now called Inquiry Based Science Education (IBSE in the following) can improve children's and students' interest in science. This view underpins some strategies that aim to promote physics in formal or informal contexts and to influence young people in their professional orientation. Such a practice may be seen as a good way to show children or older students how science works, by placing them in a context in which they can be active. This view is widely shared among researchers in physics education research and is agreed on by many academic authorities. Reports from various institutions or groups of experts (e.g. Rocard *et al.* 2007, Osborne & Dillon 2008) echo each other impressively. The "existing success" (Léna 2009a) of such a method seems an incitement to dissemination. The comments advocating this approach mention a variety of expected benefits, ranging from students' engagement with science to the development of their critical sense and responsible citizenship. Concerning learning benefits, it is not suggested that these will be less than with more traditional teaching. As claimed for instance in the report by Rocard *et al.* (2007), higher attainments levels seem to be, for many authors, an expected outcome of the recommended approach.

Given this impressive unanimity, it might be useful to examine carefully these optimistic claims, in order to discuss how to maximize the chances of success of this movement.

## **Some caveats**

Being not a new idea, the inquiry based method – broadly speaking – has long been the target of caveats. A figure (fig. 1) in a paper by Euler (2004, 193) encapsulates the essential of this question by displaying a structural loop: you understand what you see, you see what you understand. "In creating new knowledge", Euler adds, "experimental evidence is only a piece of a puzzle, a step in a longer process, and very probably not even the decisive step".

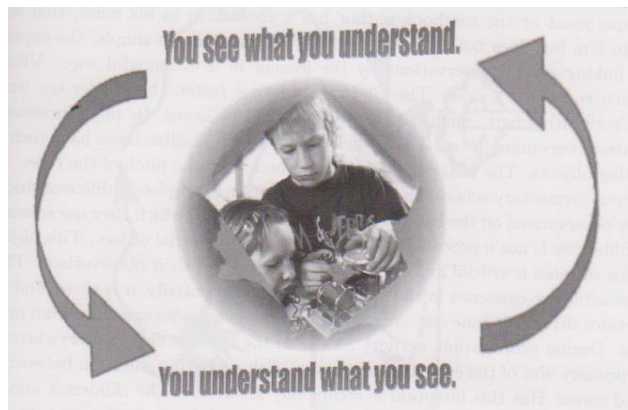


Figure 1. A figure by Euler (2004), in support to his plea for a cautious use of experiments in teaching.

Some of these long claimed caveats were very general, but they strongly resonate in the present context: « The constructivist model of learning does not carry any necessary message about models of instruction » (Millar 1989, 589); « Too often, the quality of instruction is judged on the basis of student and teacher enthusiasm, this is not valid indicator . » (McDermott 1978). There was an emphasis on the fact that any teaching method was ineffective without a thorough consideration of the taught content (Lijnse 1994, 1995, 2002; Fensham *et al.* 1993), a viewpoint that is constitutive of what is called in Europe “didactics of”, say, “physics”. Correspondingly, several authors stressed the necessity that a teaching sequence be designed and evaluated at the *micro level* (Millar 1989 ; Lijnse *ibid.*). Finally, the promoters of recent “inquiry based” attempts at improving science education were themselves aware that there had been, « Along the 60s-70s, (...), an impressive number of reforms that all failed » (Charpak 1996, *in French*, p. 9).

All these caveats, as it seems, are rather consensually accepted, at least are they not explicitly denied in the contemporary pleas for IBSE. This paper intends to contribute to a reflection about this question: how to conciliate that awareness and the loud stated claims concerning the expectable benefits of such an approach to teaching science? In particular, can we hope to have students more “excited”, more “engaged with physics” and, at the same time, have them significantly understand what we intend them to learn? Can we do better than providing learners with a scattered set of exciting teaching sessions? Can we conduct them to a view of science as a widely unified description of the material world, constructed on the basis of parsimonious and predictive theories?

## **Taking the challenge**

The perspective of this paper is to discuss how to conciliate students' excitement and their conceptual structuring. The latter component, indeed, is no less constitutive of science than the former one, and it refers to the very nature of the subject: a set of models and theories with remarkable predictive power, internal consistency and elegant parsimony, as recently underlined by Ogborn (1997, 2009).

How can we manage such a challenge, in the frame of IBSE?

A now classical approach to IBSE is the following. IBSE is meant to make ample room for the students' own intellectual activity. Therefore a question is to be solved, taking into account the learners' prior expectations. When the question refers to a phenomenon that can be practically illustrated on a small scale, an experiment is designed and carried out. Expectations on the outcomes of the experiment should be formulated and explicitly justified, in order to generate and fuel a discussion between students and/or between the students and the teacher. Once the experiment has been carried out, any conflict between what was expected and what has been observed should be negotiated. The goal is that learners should gradually reach a view that is compatible with accepted physics, and/or formulate a new question.

As recalled in introduction, these views are widely consensual nowadays. In principle, they are compatible with the various goals assigned to this type of teaching, in particular with student conceptual structuring. It might well be, however, that a predominant use of that strategy does not particularly foster an organized understanding of the taught concepts. We can search to overcome some expectable limitations in this respect. For the sake of brevity, this question will be envisaged here with a discussion focused on learners, leaving aside, though essential it may be, what concerns teachers and teacher trainers (see a few remarks in Appendix 1).

Some possible obstacles to learners' conceptual achievement are listed and discussed below, then some examples of alternatives to common practices are proposed, alternatives in line with the concern of stressing conceptual links.

The obstacles considered in the following are referred to three main ideas: the complexity of physical phenomena, some ritualistic teaching practices and what is defined below as 'echo-explanation', a type of discourse used by teachers or science mediators especially when they want to be easily understood.

## **The intrinsic complexity of physical phenomena**

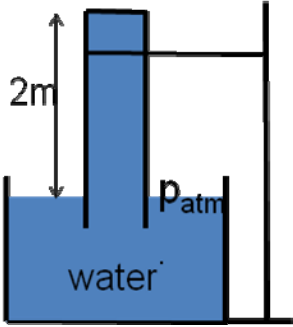

<p>a) A test-tube filled with water, above a tank of water.</p> 	<p>b) A questionable explanation</p> <p>“What is lifting this column of water up by 2m ? It's atmospheric pressure that is pushing on the water in the tank. In the tube, there is no air, and no pressure is exerted on the water.” *</p> <p>*Translated from an explanation by Marie Curie, (Chavannes 1907)</p>	<p>c) Considering orders of magnitude</p> <p>Comparing orders of magnitude of the forces acting on the column of water that are mentioned in the explanation (col. b).</p> 
---	--	--

Figure 6. A situation that can be analysed like the glass of water turned upside down (fig. 5): a test-tube full of water and turned upside down over a tank filled with water.

An expert explanation for this phenomenon was provided by Marie Curie. A book recently published presents notes taken by Isabelle Chavannes during lessons given in 1907 by Marie Curie to a few of her friends' children (including Isabelle). Referring to the setting shown in Figure 6, Isabelle Chavannes reported Marie Curie's words: “*What is raising this column of water up to 2m ? It's the atmospheric pressure that is pushing on the water in the tank. In the tube, there is no air, and no pressure is exerted on the water*” (Chavannes 1907).

With this comment, we are very close to the common and problematic explanation of the inverted glass discussed above. Such a similarity suggests that the ritual just illustrated with the first example – an inverted glass - is not simply an accident. We may then decide that it is worth suggesting alternatives, beyond just signaling the incompleteness of the ritualistic explanations.

A first strategy is to change slightly the staging of the inverted glass, by putting it in a horizontal position (fig. 7). Then, it is less tempting to ascribe the immobility of the cardboard to a balance between a force exerted by the atmosphere and the water's weight.



Figure 7. In a horizontal position, the water also does not flow out of the glass

A simple analysis of the horizontal components of the main forces leads to a more symmetrical view, which is systemic and involves both ends of the glass. The atmosphere appears as playing the role of a press rather than that of a stand. It is likely that the learning outcomes would be different, or at least that the conceptual obstacles would not be the same.

The second example does not lend itself to that kind of change, as the test tube cannot be put horizontally. But it is still very relevant to focus on the systemic aspect. As in the case of the inverted glass, *both* ends of the column of water deserve attention. Indeed, at the top of this column, the interaction between the water and the glass is equivalent to that generated by four fifths of atmospheric pressure. Stressing the links between the two situations, inverted glass or test tube, is likely to lead to a better understanding of this idea. It is even possible to discuss what a Torricelli barometer is, and to underline that there is a very small interaction, in this case, between mercury vapour and the top of the tube ( $\approx 2 \cdot 10^{-1}$  Pa). By stressing similarities and differences, via a systemic analysis, an investigation of an inverted glass, an inverted test tube and a barometer gives access to a rich and consistent conceptual content.

### **Expert echo explanations**

The two preceding examples also illustrate the idea of an expert echo-explanation (Viennot 2009, 2010a,b, Viennot and Planinsic 2009).

Let us consider the common and problematic explanations that are commonly given for these two situations. A column of water is said to be raised by atmospheric pressure and this suggests an (unbalanced) equilibrium between two forces, given that it is (erroneously) claimed or simply suggested that there is nothing else acting on the water. These two forces are, on the one hand, that due to atmosphere pressure at the basis of the column of water and, on the other hand, the weight of this column, itself assumed to be exerted on the water in the tank. Only the basis of the column seems to be considered, as though no interaction was intervening at the top.



Such explanations are compatible with some very common ideas or ways of reasoning that are repeatedly observed in students. It is often thought, indeed, that an object “exerts its weight on the stand” (to put it briefly; see previous discussion *a propos* of weighing the air), and more generally that a localized analysis is sufficient. We may then consider some expert explanations as echoing some students’ common views, in that they seem to rely on the same common trends of reasoning. To sum up, an expert “echo-explanation” can hypothetically be ascribed to the same features of reasoning as those commonly observed in learners and possibly misleading as regards accepted physics. This label does not imply any particular causal relationship between what is commonly claimed, respectively, by experts and by non-specialists. It just designates a mutual resonance.

### **Explanations that echo linear causal reasoning**

Very often, echo-explanations are mapped on a very common way of thinking in science:

#### *Linear causal reasoning*

This way of reasoning is of particular interest in that it is in stark contrast with some models commonly used in accepted physics, and particularly in elementary physics.

Consider a system comprising several objects, say two springs suspended end to end from a stand and extended by an experimenter (fig. 8), or a series circuit with two resistors and a battery, or two cylindrical vessels filled with gas and separated by a mobile piston. Such systems can be described with several variables that are constrained by simple relationships. Thus, the forces exerted by the two springs on each other are equal to that exerted by the experimenter on the lower end of the lower spring. This relationship implies a situation of mechanical equilibrium at every point in time, the same time argument being ascribed to every specific value of the quantities concerned. In other words, all the parts of the combined system are assumed to “know” all the other parts *instantaneously*, during the – *quasi-static* – evolution of this system. Thus, if the lower end is pulled by an experimenter, the relationship above is assumed to hold at any instant. This is far from obvious. In the case of an earthquake, for instance, this model would not be appropriate for analysing the changes that affect two contiguous parts of a continent. It would have to be changed to a *propagative* model.

The simultaneous evolution of all the parts of a system is far from intuitively clear. Common ways to deny such a strange hypothesis take the form of the following prototypical comment (Fauconnet 1981: 111; Viennot 2001: 98) “The first spring will extend then, after a while, the second will also extend”. Such a comment suggests that the event is seen as ‘a story’, rather than as simultaneous changes in several variables permanently constrained by the same relationships. Simple events ( $\phi_n$ ), most often specified through only one variable, are envisaged as a series of

binary cause-effect links:  $\varphi_1 \rightarrow \varphi_2 \rightarrow \varphi_3 \rightarrow (\dots) \rightarrow \varphi_n$ . (Rozier & Viennot 1991, Viennot 2001: chap. 5). The arrow used in the preceding symbolic form is often expressed in words using the adverb “then”. This is an intermediate term between the expression of a logical link (“therefore”) and a temporal succession (“later”). We can find the same type of ambiguous term in many other languages as well; for instance “alors” in French or “entonces” in Spanish. More or less surreptitiously, common explanations are steeped in time.

Figure 8 outlines the term-to-term opposition that exists between the linear common reasoning and a quasi-static, or quasi-stationary, analysis of a systemic change.

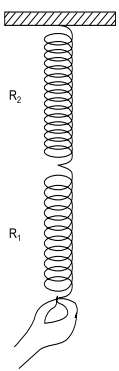
<p><b>In quasi-static physics</b></p> <ul style="list-style-type: none"> <li>- several variables</li> <li>- simultaneously changing</li> <li>- constrained by permanent relationships</li> </ul>	<p>An example</p> 	<p><b>Linear causal stories</b></p> <ul style="list-style-type: none"> <li>- simple phenomena (one variable each)</li> <li>- seen as successive (hence as)</li> <li>- temporary</li> </ul>
<p><math>\mathbf{F}_{\text{ext}}(t) = \mathbf{T}_1(\text{same } t) = \mathbf{T}_2(\text{same } t)</math>  <math>\Delta l_T(t) = \Delta l_1(\text{same } t) + \Delta l_2(\text{same } t)</math></p> <p><math>\mathbf{F}_{\text{ext}}</math>: Force exerted by an experimenter on the lower end; <math>\mathbf{T}_1, \mathbf{T}_2</math>: tensions of each spring; <math>\Delta l_1, \Delta l_2</math>: extensions of each spring, <math>\Delta l_T</math> total extension.</p>	<p><i>A symptomatic comment:</i>          “The first spring will extend then, after a while, the second will also extend.”</p>	

Figure 8. The main features of linear causal reasoning, compared to those of a quasi-static analysis.

As already pinpointed by Rozier and Viennot (1991, see also Viennot 2001: chap. 5), some expert explanations seem also to be framed by linear causal reasoning, a tendency that can be particularly perpetrated by authors of science popularizations. The following example was much more recently pinpointed (Viennot 2010a,b, Viennot and Planinsic 2009).

### *A siphoning process*

An explanation, again given by Marie Curie (Chavannes 1907: 62), makes use of the following argument. *The water in the long branch of the siphon flows out. A vacuum is created, and the atmospheric pressure pushes the water of the tank up the short branch.*

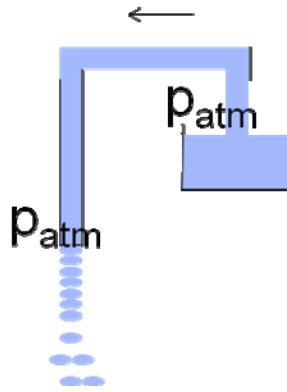


Figure 9. A siphoning process.

Using the schematic presentation shown in fig. 9, we might paraphrase this explanation as follows:

$\varphi_1$  (left end of the tube, on fig. 9): *The water in the long branch of the siphon flows out*  $\rightarrow$   $\varphi_2$  (somewhere in the tube) *A vacuum is created*  $\rightarrow$   $\varphi_3$  (right end of the tube on fig. 9) *the atmospheric pressure pushes the water in the tank up the small branch.*

Simple events are envisaged successively, if only temporarily (for instance: “the vacuum”), as though in chronological succession. In particular, this would seem to suggest that it is possible to analyse what happens at one end of the system independently of what happens at the other.

There is one clear problem: The role of the atmosphere is called on for the last link of the explanation, which concerns one end, but there is atmospheric pressure at the other end as well.

The adjectives “long” and “short” constitute a clue which discretely points towards the crucial role of a difference. Most probably, this clue is not sufficient for learners who do not already know how to analyse this system. It might well be thought, for instance, that the water flows out of “the long pipe” simply because its lower end is open. The resonance between this explanation and linear causal reasoning, clearly, may result in improper interpretations.

### Stressing links and the decisive role of some differences

Rituals and echo explanations are often concomitant. An improved awareness, a critical analysis and a deliberate specification of teaching goals may open wider the conceptual space that is potentially accessible to students.

Thus, still using the same device, it may be decided to stress the systemic aspect of a siphon. To this end, the students can be first presented with a system analogous to that shown in Figure 9 but with a mask hiding the right-hand side (fig. 10a); the student could be asked to predict: What would happen if the lower end of the left-hand branch, initially blocked, were freed?

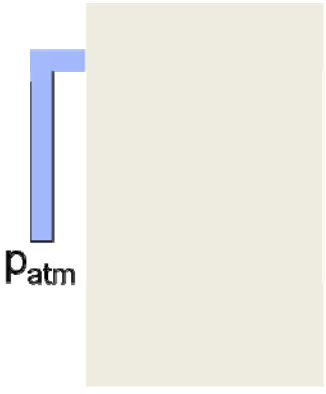
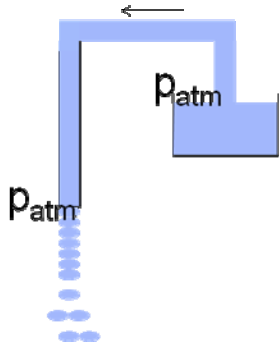
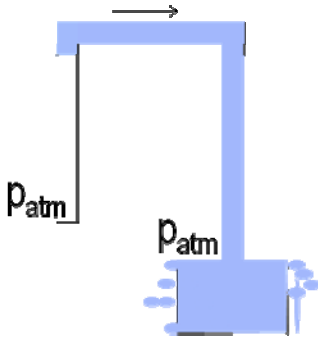
		
<p style="text-align: center;">a</p> <p>What will happen when the left-hand branch is opened at its lower end? (Right-hand part of the system: hidden)</p>	<p style="text-align: center;">b</p> <p>A case currently explained by experts (e.g. Marie Curie: Chavannes 1907)</p>	<p style="text-align: center;">c</p> <p>With the same left-hand branch, a different outcome is observed</p>

Figure 10. Without considering both sides of a siphon, the outcome of the experiment cannot be predicted.

Once performed, the experiment would confirm what is commonly expected: the water in the left-hand branch flows out. When the mask is taken off (fig. 10b), the students can see that the vessel empties, which is the usual goal of a siphoning process. But the experiment could also be performed for a different outcome. Behind the mask, and with exactly the same visible part on the left, it is possible to place the tank of water such that its free surface is *lower* than the end of the left-hand branch (fig. 10c). Then, when the left-hand end of the tube is opened, the water does not flow out. Instead, the water rises up the tube and refills the tank.

This is a striking illustration that, without seeing *both* ends of the system, it is impossible to predict what the water will do. This is the most important thing to be understood concerning a siphon. Beyond that, with a modest setting, and with an audience that is still at a low level of competence, it is possible to stress a crucial aspect of physical phenomena: the world runs on *differences* (Boohan and Ogborn 1997).

Keeping in mind this kind of a message – briefly put, the relevance of a systemic approach – the staging of other experiments can be re-orientated accordingly, as illustrated by the following example.

A “love-meter” is shown in Figure 11. Warming up the lower part with the hands results in a nice fountain effect, with the liquid partly filling in the upper part whilst its level decreases in the lower part. The usual explanation is that warming up the gas in the lower part increases the pressure there, which pushes the liquid up the tube joining the bottom of the lower part to the bottom of the upper part. Here, we recognize linear causal reasoning.



Figure 11. A “love-meter” with the classical staging.

In order to highlight the target idea more effectively, we could formulate the explanation more precisely, changing “the pressure increases in the lower part” to “the *difference* of pressure between the *two* parts is increased”, thus taking into account both parts of the system. With such a target in mind, it would become natural to complete the classical demonstration of the love-meter experiment with the following variation (fig. 12b): cooling down the upper bulb, for instance with cold water. The outcome is of course the same as with the usual version, which constitutes a rather striking effect.

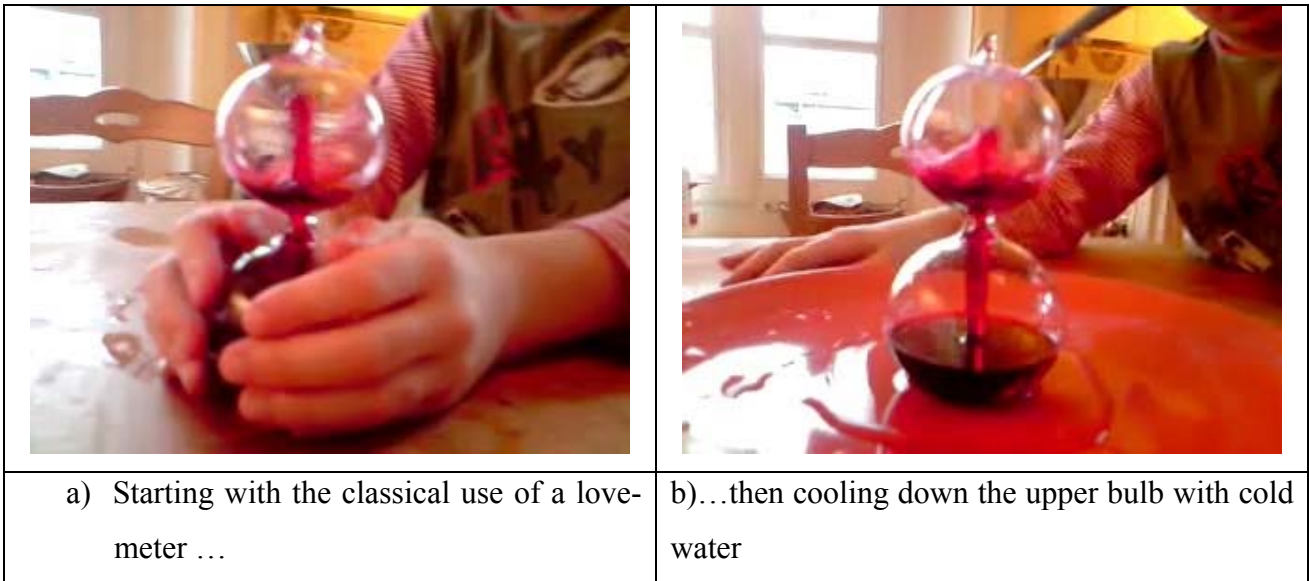


Figure 12. A staging of the demonstration that focuses on a systemic analysis

Among other activities, these two examples – siphon and love-meter – could be used to emphasise the consistency of physics and the power of its theoretical foundations: in this case the idea that the world runs on differences.

### **A consensual method, a variety of likely outcomes**

The preceding examples, particularly the two last ones, suggest a first conclusion. We may well agree on a general pedagogical frame to have the students active, engaged, excited, critical, etc. But inside such a framework, what remains to be decided is considerable, as is the range of likely outcomes. The positive side of that state of affairs is that, provided the limits of some common practices are recognised and analysed, there is room to maneuver in. Even with severe teaching constraints, there are some open choices and levers for targeted actions. Some apparently minor changes in ritualistic practices may bring out important outcomes. These “critical details” of practice (Viennot *et al.* 2004), when orientated by a sound analysis of the content and a sufficient knowledge of students’ common ideas and ways of reasoning, open up a range of different targets. Being vigilant about our own explanations, which may in fact mirror some problematic features of common reasoning, is a preliminary condition. Among the possible goals that might influence what we choose to spotlight in exploring any given content is that of stressing conceptual links, thus highlighting how consistent, predictive and concise physical theories may be, in specified domains of validity.

## Some crucial questions

As recently recalled in many pleas for IBSE, “(...) the learning process of scientists (*consists in*): formulating questions, doing experiments, collecting and comparing data, reaching conclusions and extrapolating these findings to more general conclusions. (Allende 2008)

Thus, a recurrent invocation concerning science is that of a questioning approach. Consistently, it would be problematic, concerning IBSE, to depart from this attitude. This paper recalls and/or illustrates some caveats, suggests some reasons and ways to be both cautious and positively engaged with IBSE. That is, of course, far from exhausting the topic. Among the vivid questions left open, we find:

*How can we evaluate our assertions about IBSE?*

As recalled in introduction, many claims were expressed to justify and accompany the reactivating process of IBSE approaches. Given the preceding failures in the 70s, there was an urgent need, after about a decade of “recent” IBSE, to formally evaluate the outcomes. This paper being focused on learners, it must be noticed that, in this regard, very few results were available until recently, beyond teachers reporting. Recently, a formal evaluation has been conducted on a large scale in the frame of the Pollen project (2006-2009). One of the questions examined was whether IBSE was actually fostering pupils’ liking of science. A striking results concerns a cohort of pupils, aged 10-11, who were exposed during two years (in Berlin) to IBSE, with pre and post tests posed to the same pupils. The authors (Jarvis *et al.* 2009) conclude: “*Most of the individual item scores relating to pupils’ liking of science experiments also fall significantly over the two years (...), with girls scores falling more strongly. This pattern of decline in liking school and science is common in many countries as primary pupils get older (Jarvis & Pell 2002; Piburn & Baker 1993). It should not be surprising that there should not be a notable change in typical pupil responses because of the Pollen Project.*” This comment is in stark contrast with many loud stated claims. It demonstrates the utility of a lucid, non dogmatic attitude.

First of all, it appears that we should search for relevant variables concerning, this time, IBSE, in order better to master its outcomes. Thus, the investigation by Jarvis and her colleagues provides interesting results. Pupils in Leicester (N= 301-554, aged 7-11), were asked to rank various items on a five-points Likert scale. It was found that the item “science is just too difficult” was ranked significantly lower after one year of IBSE. In contrast, no significant difference was observed concerning the items “(...) Finding out why the experiment works” and “Science makes me think”. Strikingly, the same kind of results are reported in the investigation conducted in several European countries by Lindahl (2009), still within Pollen project.

Such studies can help us improve our practice. Here in particular, the results pose the question of developing a more conceptual component in IBSE. Indeed, at least through some pupils' responses, science does not present insuperable difficulties but does not seem more intellectually stimulating after a long period of inquiry based teaching.

*How does IBSE affect students' conceptual achievements and intellectual satisfaction?*

Physics education research has long been concerned by evaluating students' understanding of scientific concepts, before, during and after teaching. By contrast, the recent reactivation of IBSE was most often accompanied by evaluations that were nearly exclusively focused on students' or on teachers' attitudes as regards science (see for instance the investigation by Pollen, just quoted). As recalled above, there is a need to keep evaluating *at a fine grained level* what students actually grasp of science concepts, in such and such teaching conditions.

Besides the question of students' conceptual achievements, and probably tightly linked to that aspect, the level of students' intellectual satisfaction is a crucial point to be investigated. Intellectual satisfaction is at a junction between affectivity and conceptual progress. It is a feeling linked to the impression of having understood a complex topic to a certain extent, one that can be identified quite clearly, this being accomplished with a good quality/cost ratio (Viennot 2006, Mathé and Viennot 2009, Feller *et al.* 2010). Often, affective factors are envisaged as *conditions* for learning (for instance Pintrich *et al.*, 1993; Rhöneck *et al.* 1998; Glynn *et al.*, 2007, Launkenmann *et al.*, 2003). But seen as a possible *outcome* of learning, intellectual satisfaction is – most probably - crucially linked to one of the main goals of IBSE enterprises: having students engaging with science, *in the long term*.

*IBSE from primary school to the end of secondary school: what transitions?*

This point leads us to a crucial aspect of IBSE: the transition from a major focus on scientific inquiry, on the one hand, to a more systematic approach to science conceptual organization, on the other hand. As recalled by Rocard *et al.* (2007: 12), “The two approaches are not mutually exclusive, and can and should be combined in any science classroom to accommodate for different kinds of scientific topics, different mindsets and age groups preferences.” In practice, the dosage to be adopted in a given context is far from obvious. We can read different suggestions concerning the crucial steps. Thus, according to Léna (2009b), there would be, in some European countries, a “5 to 16” golden age of inquiry based approaches: “In all four nations (*France, Germany, Netherlands, Sweden*), the ‘science as inquiry’ pedagogy encourages students (from 5 to 16) to develop a sense of wonder, observation and logical reasoning”. Osborne and Dillon, recommend that this approach



prevail “before 14”: “EU countries should ensure that: (...) the emphasis in science education before 14 should be on engaging students with science and scientific phenomena. Evidence suggests that this is best achieved through opportunities for extended investigation work and hands-on experimentation and not through a stress on the acquisition of canonical concepts.” (Osborne & Dillon 2008: 9).

It is crucially important that a thorough reflection be conducted on how and when to manage the decisive transitions. In order to inform this question, it is urgently needed to conduct carefully designed research programs.

### **Concluding remarks**

These crucial questions – a few among many others - may seem discouragingly complex. They just echo some of the recurrent debates in science education, and there is no reason why IBSE should get round these. The real challenge is to keep the wonderful impulse recently given to IBSE while keeping in mind those questions and maintaining a lucid effort to progress in these respects.

At least can we say that a condition for success is to reject any manicheism. Phil Scott very recently expressed a concern about this tendency: “*A worrying trend that I detect sees new approaches being set up in opposition to each other in an unhealthy dichotomy (...) Furthermore, and all too often, approaches to teaching scientific conceptual knowledge are cast as being 'traditional', 'didactic' and 'bad', whilst inquiry approaches are seen as being 'innovative', 'child-centred' and 'good'.*” (Scott 2009). Yet, the report by Rocard, just cited, had well specified: “The two approaches are not mutually exclusive, ...”. But, in practice, one or two useful sentences in a report are not enough to ensure a generalized, harmonious and efficient ‘full repertoire’ approach to teaching. To this end, it would be highly fruitful, I suggest, to seriously consider this idea: It is essential that students reach a certain degree of intellectual satisfaction. In this regards, a strong lever is – a propos of inquiry based approaches as well - to favour conceptual structuring by stressing links between phenomena and laws. Thus, the different reasons to like science might be reconciled, in an efficient synergy. We might expect to have learners truly engaging with science, beyond mere excitement and in the long term.

### **References**

- Alberts, B. 2008. Considering Science Education, *Science*, 319, 21-3-2008. Editorial. p. 1589
- Allende, J.E. 2008. Academies Active in Education, *Science*, 321, 29-8-2008. Editorial.
- Boohan, R. & Ogborn, J. 1997. Differences, energy and change : a simple approach through pictures, *New ways of teaching physics* - Proceedings of the GIREP International Conference 1996 in Ljubliana, S. Oblack, M.Hribar, K. Luchner, M. Munih, Board of Education Slovenia.

- Charpak, G. 1996. *La main à la pâte. Les sciences à l'école primaire*. Flammarion, p. 9.
- Charpak, G. 2005. La main à la pâte. *Science et Avenir*. n°698, Avril 2005. p. 11.
- Chauvet, F. 1996. Teaching colour: designing and evaluation of a sequence, *European Journal of Teacher Education*, vol 19, n°2, pp 119-134.
- Chauvet, F.1999. STTIS Project, *Colour sequence* University " Denis Diderot ", LDAR (Laboratoire de didactique André Revuz); and STTIS (Science Teacher Training in an Information Society) web sites: (retrieved 1.7.2010) [http://www.lar.univ-paris-diderot.fr/sttis\\_p7/color\\_sequence/page\\_mere.htm](http://www.lar.univ-paris-diderot.fr/sttis_p7/color_sequence/page_mere.htm) or <http://crecim.uab.cat/websttis/index.html>
- Chavannes, I. 1907. *Physique élémentaire pour les enfants de nos amis*. Leçons de Marie Curie, recueillies par Isabelle Chavannes en 1907. Dir. B. Leclercq, Paris : EDP Sciences, 2003
- Euler, M. 2004. The role of experiments in the teaching and learning of physics. *Research in physics Education*, Varenna course CLVI, Amsterdam: IOS Press, pp. 175-221.
- Fauconnet, S. 1981. *Etude de résolution de problèmes: quelques problèmes de même structure en physique*, Thèse de troisième cycle, Université Paris 7.
- Feller, I., Colin, P. & Viennot, L. 2009. Critical analysis of popularisation documents in the physics classroom. An action-research in grade 10. *Problems of education in the 21st century*. 17(17): pp.72-96.
- Fensham, P., Gunstone, R & White, R. (Eds) 1994. *"The Content of Science: a constructivist approach to its teaching and learning"*, The Falmer Press, London
- Glynn, S. M., Taasobshirazi, G., & Brickman, P. 2007. Nonscience majors learning science: A theoretical model of motivation. *Journal of Research in Science Teaching*, 44(8), PP.1088–1107.
- Jarvis, T. & Pell, A. 2002. Changes in primary boys' and girls' attitudes to school and science during a two-year science in-service programme. *The Curriculum Journal* 13(1), pp. 43-69.
- Jarvis, T., Pell, A. & Hingley, P. 2009. Pollen Primary Teachers' Changing Confidence and Attitudes over Two Years Pollen In-service. [www.pollen-europa.net/](http://www.pollen-europa.net/)
- Laukenmann, M., Bleicher M., Fub, S., Gläser-Zikuda, M., Mayring, P., & Rhöneck, C. V. 2003. An investigation of the influence of emotional factors on learning in physics instruction. *IJSE*, 25(4), pp.489-507.
- Leach, J. & Scott, P. 2002. Designing and evaluating science teaching sequences: an approach drawing upon the concept of learning demand and a social constructivist perspective on learning. *Studies in Science Education*, 38, pp. 115-142.
- Leach, J. & Scott, P. 2003. Learning science in the classroom: Drawing on individual and social perspectives. *Science and Education*, 12(1), pp. 91-113.
- Leach, J., Ametler, J. & Scott, P. 2010. Establishing and communicating knowledge about teaching and learning scientific content: The role of design briefs, In K. Kortland (ed.): *Designing Theory-Based Teaching-Learning Sequences for Science Education*. Utrecht: Cdβ press, pp. 9-38.
- Léna, P. 2009a. Towards an European strategy in elementary science education. In G. Santoro (ed.), *"New Trends in Science and Technology Education" Conference, Abstract booklet*, "Università di Modena e Reggio Emilia, p. 71.
- Léna, P. 2009b. Europe rethinks education, *Science*, 326, 23-11-2009
- Lijnse, P.L. 1994. La recherche-développement: une voie vers une "structure didactique" de la physique empiriquement fondée, *Didaskalia* n°3, pp. 93-108.
- Lijnse, P.L. 1995. 'Developmental research' as a way to an empirically based 'didactical structure' of science. *Science Education*, 79, 189-199.
- Lijnse, P.L. 1998. Curriculum development in physics education. In E. Sassi and M. Vicentini (Eds.): *Physics Education: recent developments in the interaction between research and teaching*, *International Commission of Physics Education*, <http://web.phys.ksu.edu/icpe/Publications/index.html>

- Lijnse, P.L. 2002. Didactics of science: the forgotten dimension in science education research. In R. Millar, J. Leach and J. Osborne (Eds.): *Improving Science Education – The contribution of research*, Buckingham: Open University Press. pp. 308-326.
- Lindahl, B. 2009. Changes in pupils' attitudes towards science during two years within the Pollen project, [www.pollen.europa.net](http://www.pollen.europa.net)
- Mathé, S., & Viennot, L. 2009. Stressing the coherence of physics: Students journalists' and science mediators' reactions, *Problems of education in the 21st century*. 11 (11), pp. 104-128.
- McDermott L.C. 1998. Research in Physics Education, *International Newsletter on Physics Education* (ICPE-IUPAP), 36, 1-3. (p. 3)
- Millar, R. 1989. Constructive criticisms, *International Journal of Science Education*, Special issue, 11 (5), pp. 587-596.
- MUSE <http://education.epsdivisions.org/muse/>
- Nillsen, R. 2009. Can the love of learning be taught? *The Pantaneto forum*, 36, [www.pantaneto.co.uk/issue36/nillsen.htm](http://www.pantaneto.co.uk/issue36/nillsen.htm)
- Ogborn, J. 1997. Constructivist metaphors of learning science. *Science & Education*, 6, pp. 121-133.
- Ogborn, J. 2009. Science and common sense. In E. Sassi and M. Vicentini (eds.): *Physics Education: recent developments in the interaction between research and teaching*, (section A1), International Commission of Physics Education, <http://web.phys.ksu.edu/icpe/Publications/index.html>
- Ogborn, J. 2010. Curriculum development as practical activity. In K. Kortland (ed.): *Designing Theory-Based Teaching-Learning Sequences for Science Education*. Utrecht: Cdβ press, 71-80.
- Osborne, J., Dillon, J. 2008. *Science Education in Europe : Critical Reflexions*. Nuffield Foundation, [www.nuffieldfoundation.org/fileLibrary/pdf/Sci\\_Ed\\_in\\_Europe\\_Report\\_Final.pdf](http://www.nuffieldfoundation.org/fileLibrary/pdf/Sci_Ed_in_Europe_Report_Final.pdf)
- Piburn, M.D. & Beker, D.R. 1993. If we were the teacher ...Qualitative Study of Attitude towards Science. *Science Education*, 77, 393-406.
- Pinto, R. (coord.), Ogborn, J., Quale, A., Sassi, E. & Viennot, L. 2001. *STTIS : "Science Teacher Training in an Information Society"*, European Commission, Brussels N° SOE2-CT97 20 20., <http://crecim.uab.cat/websttis/index.html>
- Pintrich, P. R., Marx, R. W., & Boyle, R. A. 1993. Beyond cold conceptual change: The role of motivational beliefs and classroom contextual factors in the process of conceptual change. *Review of Educational Research*, 63(2), 167-199.
- Planinsic, G. & Viennot, L. 2010. *Stories of light*, Muse project, URL: <http://education.epsdivisions.org/muse/>
- Planinsic, G. 2004. Color Light mixer for every student, *The Physics Teacher*, 42, pp. 138-142
- Posner, C. J., Strike, K. A., Hewson, P. W. & Gertzog, W. A. 1982. Accommodation of a scientific conception: toward a theory of conceptual change. *Science Education* 66(2), pp. 211-227.
- Rhöneck, C. V., Grob, K., Schnaitmann, G. W., & Völker, B. (1998). Learning in basic electricity: how do motivation, cognitive and classroom climate factors influence achievement in physics? *International Journal of Science Education*, 20(5), pp. 551-565.
- Rocard, Y. 2007, *Science Education Now*, Report EU22-845, European Commission, Brussels, [http://ec.europa.eu/research/science-society/document\\_library/pdf\\_06/report-rocard-on-science-education\\_en.pdf](http://ec.europa.eu/research/science-society/document_library/pdf_06/report-rocard-on-science-education_en.pdf)
- Rozier S., Viennot L. 1991, Students' reasoning in thermodynamics, *International Journal of Science Education*, Vol 13 n°2, pp. 159-170.
- Scott, P. 2009. *Teaching Physics Concepts: A neglected Art?* Plenary address, GIREP 2009 Leicester.
- STTIS:** <http://www.lar.univ-paris-diderot.fr/materiaux-pedagogique/sequence-module>
- Viennot, L. 2001. *Reasoning in physics*. The part of common sense, Brussels: Kluwer.
- Viennot L. 2003. *Teaching physics*. With the collaboration of U. Besson, F. Chauvet, P. Colin, C. Hirn-Chaine, W. Kaminski, S. Ranson. Trad. M. Greenwood & A. Moisy. Dordrecht: Kluwer Ac. Pub.

- Viennot, L., Chauvet, F., Colin, P. & Rebmann, G. 2004. Designing Strategies and Tools for Teacher Training, the Role of Critical Details. Examples in Optics. *Science Education*, 89 (1), pp. 13-27.
- Viennot, L. 2006. Teaching rituals and students' intellectual satisfaction. *Physics Education*, 41, 400-408.
- Viennot, L. 2009. Some experiments in fluids statics, In Planinsic, G., Sassi, E., Ucke, C. and Viennot, L., MUSE project, URL: <http://education.epsdivisions.org/muse/>
- Viennot, L. & Planinsic, G. 2009. The siphon: a staging focused on a systemic analysis, *MUSE project of the EPS-PED*; <http://education.epsdivisions.org/muse>
- Viennot, L. 2010a. Physics by inquiry: beyond rituals and echo-explanations, In L. Menabue and G. Santoro (Eds.) *New Trends in Science and Technology Education, Selected papers*, , Bologna: CLUEB. Vol. 1, pp. 240-256.
- Viennot, L. 2010b. Physics education research and inquiry-based teaching : a question of didactical consistency, In K. Kortland (ed.): *Designing Theory-Based Teaching-Learning Sequences for Science Education*. Utrecht: Cdβ press, 39-56.
- Weltin, H. 1961. A paradox. *American Journal of Physics*, 29 (10), pp. 712-711.

## Appendix 1

*How better to help and/or train teachers to perform careful IBSE?*

Given time constraints, some important themes concerning teachers have not been discussed in the address reported here. Yet, as repeatedly claimed, teachers' role is absolutely decisive. As always when an innovation is launched in an educative system, or even experimented at smaller scale, teachers are active transformers of the suggested design (e.g. STTIS 2000, Leach et al. 2002, Millar 2010, Ogborn 2010).

No doubt that, in order to help teachers take a first step, it is very useful to provide them with general considerations on IBSE along with exemplary items, for instance posted on a resource web-site (LaMap, Pollen, Sinus Transfer), or even kit-boxes. Training sessions *in vivo*, or accompanied teaching sessions, whenever possible, are of course likely to favour a better interaction between the designers and the teachers who are supposed to appropriate the recommended innovation.

In any case, it would be highly contestable to adopt a transmissive approach: The very label of exemplarity is questionable, because what is advisable in a given teaching context (teacher included), may be very problematic in another one. For instance, as remarked by Jarvit *et al.* (2009): "Kit-boxes are a valuable strategy for supporting schools and teachers with little background in teaching science. (...) Long term, the boxes may inhibit able teachers' creativity and enthusiasm."







Consequently, it is probably fruitful to propose, for any given theme of physics, a menu, be it with a resource web-site or not. That could comprise, besides some information about the content, a description of students' common ideas, a critical analysis of possible ritualistic practices - explanations or ways of staging an experiment-, and suggestions of alternatives *along with their justifications*, constructed accordingly. Given that the teachers trace their own way when they

decide what to do the next day, such a format should incite them to take responsibility for the didactic consistency of their personal choice; in other words, to look for an optimized agreement between the retained teaching goals and the chosen strategies, given students' pre instructional ideas and expectable reactions. More widely, this idea of a *didactic consistency* might constitute the master word of teacher training sessions. Then, in line with a problem posing approach (Lijnse 1995, 1998, 2002), teachers could be trained to evaluate to which extent some hypothetical design briefs (Leach *et al.* 2010) are didactically consistent. Several resource web-sites (STTIS , MUSE) are built on such principles.

## **Appendix 2**

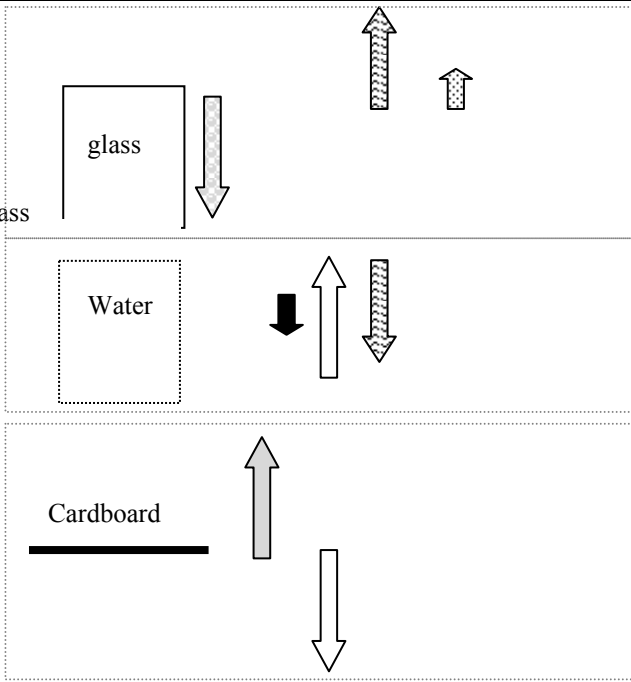
### *An elementary analysis of the “inverted glass” situation, with dislocated diagrams*

Main forces (vertical components) in the situation of the glass full of water held upside down (for more detail, see Weltin 1961, Viennot *et al.* 2009): (a) shows an exploded view of the water-glass-cardboard system in which the arrows indicate the interaction forces, (b) shows the balance between the various forces acting on the system water+glass+cardboard.

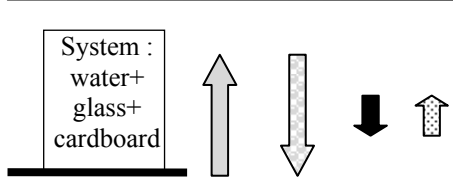
- One colour per interaction :*
-  -The Earth/water (weight)
  -  - atmosphere/cardboard
  -  - atmosphere/bottom of the glass
  -  - water/cardboard
  -  - water/bottom of the glass
  -  -hand/glass

*Each dotted rectangle regroups the elements for a Newtonian balance of forces on the object concerned*

- For each object, no particular attention is given to the exact point of application of the forces because only the motion of the centre of inertia is involved here.
- Lateral shift of the arrows: to facilitate the reading
- Orders of magnitude not respected : factor x100 between the force exerted by the external air on the cardboard and the weight of the water
- Weight of the cardboard: not represented, very small with respect to other forces
- Other forces concerning the cardboard: not represented, very small with respect to other forces



**a dislocated diagram**



**b diagram for regrouped objects**

## **Helping our students learn physics and think like scientists**

Eugenia Etkina, Anna Karelina, Maria Ruibal Villasenor, Rebecca Jordan, and Cindy Hmelo-Silver  
Rutgers University

**Abstract:** Most of our students will not become professional physicists. What and how should they learn in their introductory college physics courses so that they can not only explain some physical phenomena and solve simple problems but also develop processes and habits of mind (we call them scientific abilities) that help them analyze real world problems using strategies of the scientific community. One of the possible solutions is to engage students in experimental design. This paper describes how we can bring design into an introductory physics lab, what scientific abilities students can develop, how long it takes, and whether the students transfer those abilities to content areas outside of physics.

### **Introduction**

This paper describes an experimental design study in an introductory college course whose goal was to investigate the effects of instructional laboratories in which students design their own experiments on student their of physics and acquisition and transfer of scientific abilities.

The experiment was conducted at a US public university in a large-enrollment algebra-based physics course (with an integrated lab) for science majors (but not physics majors). The purpose of the experiment was to test the *hypothesis* that students who learn in a educational environment that resembles scientific inquiry and who design their own experiments in a physics lab not only can learn as much physics content as those students who follow the directions in guided laboratory materials, but also can acquire and transfer scientific abilities better than their counterparts. The *independent variable* in this experiment was the type of learning experiences that the subjects encountered in the lab: they had to complete assignments that were similar in terms of the physics involved but very different in nature. Excluding the laboratories, all participants experienced the same learning environments and worked on the same tasks: the students attended the same large-room meetings and problem-solving sessions that that were based on the *Investigative Science Learning Environment (ISLE)* philosophy (Etkina and Van Heuvelen, 2007). The *dependent variable* in this experiment was the extent of student learning and transfer revealed in their performance on the exams and on special experimental tasks. This was measured by exams grades, the coding of lab reports using “scientific abilities” rubrics, and the amount of time that students spent on different activities during the labs.

In order to make the comparisons possible, we split the course lab sections into two groups of equal size (about 90 students in each). The students in the treatment group (called design group) designed their own experiments and composed sophisticated lab reports in which they described and explained their experimental procedure, evaluated experimental uncertainties, justified theoretical assumptions, etc. The students in the control group (non-design students) performed the same experiments but were guided by the directions in lab handouts. The assumptions instructions for evaluating the uncertainties were provided for them. In contrast, the students in the design group had to struggle and find the answers with thoughtful efforts similar to scientists doing research.

The research questions were whether the students who during one semester design their own experiments and are compelled to concentrate on the elements of the scientific investigation,

(a) develop physics knowledge and problem solving abilities comparable to those students who perform similar lab exercises but do not design their own experiments;

(b) acquire and are able to transfer scientific abilities to an area of physics that they have not studied before;

(c) are able to transfer scientific abilities to a different subject matter.

### **Motivation**

There are two big motivations for this study: (1) Recent reports concerning science and engineering education encourage student acquisition of conceptual and quantitative understanding of physics principles *and* also the acquisition of abilities to: design their own experiments, reason from the data, construct explanatory models, solve complex problems, work with other people, and communicate (Bybee and DeBoer, 1994; Alberts, 2000). Should we spend time on the development of these latter abilities or this will harm students' acquisition of physics conceptual learning and ability to solve traditional problems? (2) Many experiments indicate that the ability to transfer what is learned in physics to other unstudied physics areas, to other academic disciplines, and to work after academia is lacking. Can students transfer what they learn in our physics design labs to other unstudied areas of physics and to other academic disciplines?

### **Theoretical foundation**

In the behaviorist tradition the term "transfer of learning" indicates extent of the repetition of an old behavior to a new situation (Detterman,1993). In educational psychology the



definition is a little more ample and “transfer” refers to ability to apply knowledge or procedures learned in a context to a different one (Bransford, Brown & Cocking, 2000). However, as argued by Schwartz, Bransford and Sears (2005), this last definition is still too restrictive and does not truthfully reflect the intricacies of the phenomenon of transfer, because it concentrates too much on individuals’ capacity for directly applying previously acquired knowledge to new contexts. This constrain in the conception of transfer shows, for instance, in classical studies of analogical transfer where the researchers tested the subjects in environments with no access to external resources and not opportunities to try out and revise their ideas (Gick & Holyoak, 1980; Halpern, 1998). The paradigm of direct application transfer makes the people appear incompetent because they have serious difficulties solving problems or completing tasks very similar to others presented to them before. The skills acquisition literature has shown that several learning trials are needed before researchers could find transfer of skills. In consequence we conclude with Schwartz, Bransford and Sears (2005) that transfer is not reduced to the modification and utilization of knowledge gained at an earlier time, but also it must include the effects of the person’s own knowledge on the construction of new one. Finally, the work of Lobato shows that transfer occurs often and the problem is in its recognition by researchers, not its existence (Lobato, 2005).

There are several theoretical models of transfer. The most relevant to this study are direct applications transfer, recognition of affordances, preparation for future learning transfer, and actor-oriented transfer. For any kind of transfer to occur, the learning environment should have such features as: focusing students’ attention on pattern recognition among cases and induction of general schemas from a diversity of problems (Gentner, Lowenstein and Thompson, 2003); engaging students in meta-cognitive reflection on implemented strategies (Catrambone and Holyoak, 1989); and presenting students with contrasting cases.

### **ISLE learning philosophy, scientific abilities and ISLE labs**

#### ***ISLE philosophy***

Investigative Science Learning Environment (Etkina and Van Heuvelen, 2001, 2007) is a comprehensive algebra-based physics learning system that provides an overarching philosophy and specific activities for all elements of a college physics course- lectures (we call them large room meetings), problem solving recitations and labs. *ISLE* students start each conceptual unit

by observing carefully selected physical phenomena (the experiments chosen for this stage of learning are usually very simple with clear emerging patterns). Students do not make predictions about the outcomes of these experiments; instead they collect data and look for patterns in the data. Then students construct ideas/rules to explain their experimental observations. When appropriate, students are encouraged to suggest multiple explanations for the same experiment. The fact that all explanations have equal weights before they are tested allows students to freely express their ideas, often based on everyday experience, without waiting for authority for validation. Students can use their contextual and epistemological resources to help in constructing explanations (Hammer and Elby, 2003). Students then have to come up with experiments that will test each of the proposed explanations/rules by predicting the outcomes of new experiments using hypothetico-deductive reasoning (if-then) (Lawson, 2003). They learn that explanations cannot be proved, only rejected. After performing the testing experiments, students revise and/or discard their explanations when necessary. Sometimes testing experiments reveal new features of the phenomenon that students try to explain, and the cycle starts again. They then use tested explanations/rules to explain everyday experiences and to solve problems.

Often students need to test alternative ideas at this stage of the cycle (the ideas are provided). These ideas are based on student difficulties documented by physics education research (PER). Some students might have the same ideas even after the cycle is completed. Thus “testing” them provides an opportunity for the students to examine why a particular idea leads to predictions that do not match the outcomes of the experiments. However, students do not have a personal stake in these predictions, as they are testing “somebody else’s” ideas.

Students follow similar cycles for each conceptual unit and continuously reflect on “how they know what they know”. At each stage students work collaboratively (in groups), sharing ideas and trying to convince each other. This approach resembles the processes that the scientific community uses to acquire knowledge.

The sequences of observational experiments, finding patterns, explaining patterns, testing and applying them repeats twice for each conceptual unit first at a qualitative level and then at a quantitative.

### ***Scientific abilities***

One of the major goals of *ISLE* is to help students develop scientific abilities (Etkina et

al., 2006). We use the term “scientific abilities” to describe some of the most important procedures, processes, and methods that scientists use when constructing knowledge and when solving experimental problems. We use the term scientific abilities instead of science-process skills to underscore that these are not automatic skills, but are instead processes that students need to use reflectively and critically (Salomon and Perkins, 1989). The list of scientific abilities that our physics education research group developed includes (A) the ability to represent physical processes in multiple ways; (B) the ability to devise and test a qualitative explanation or quantitative relationship; (C) the ability to modify a qualitative explanation or quantitative relationship; (D) the ability to design an experimental investigation; (E) the ability to collect and analyze data; (F) the ability to evaluate experimental predictions and outcomes, conceptual claims, problem solutions, and models, and (G) the ability to communicate (for details of this work see Etkina et al., 2006). The above abilities involve many sub-abilities. For example, for the ability to collect and analyze data we identified the following subabilities: (i) the ability to identify sources of experimental uncertainty, (ii) the ability to evaluate how experimental uncertainties might affect the data, (iii) the ability to minimize experimental uncertainty, (iv) the ability to record and represent data in a meaningful way, and (v) the ability to analyze data appropriately.

To help students develop these abilities, *ISLE* curriculum provides formative assessment activities (Black and Wiliam, 1998) in which feedback is built-in through formative assessment rubrics (Etkina et al., 2006). The rubrics contain descriptions of different levels of performance, including the target level of ability development. A student or a group of students can use the rubric to help self-assess her or their own work. An instructor can use the rubric to evaluate students’ responses and to provide feedback.

Each item in the rubrics corresponds to one of the subabilities. The descriptors of student work that could merit a particular score are on a scale of 0–3 (0, missing; 1, inadequate; 2, needs some improvement; and 3, adequate) and. For example, for the subability “to record and represent data in a meaningful way” a score of 0 means that the data are either missing or incomprehensible, a score of 1 means that some important data are missing, a score of 2 means that all important data are present but recorded in a way that requires some effort to comprehend, and a score of 3 means that all important data are present, organized, and recorded clearly. The rubrics were developed and validated by our research group of 9 members, who

achieved an inter-rater reliability of 95%. An example of a rubric is shown in Figure 1 below.

Figure 1. An example of a rubric for one sub-ability.

Scientific Ability	Missing (0)	Inadequate (1)	Needs some improvement (2)	Adequate (3)
Is able to evaluate the results by means of an independent method	No attempt is made to evaluate the consistency of the result using an independent method.	A second independent method is used to evaluate the results. However there is little or no discussion about the differences in the results due to the two methods.	A second independent method is used to evaluate the results. The results of the two methods are compared using experimental uncertainties. But there is little or no discussion of the possible reasons for the differences when the results are different.	A second independent method is used to evaluate the results and the evaluation is done with the experimental uncertainties. The discrepancy between the results of the two methods, and possible reasons are discussed.

### *ISLE instructional laboratories*

The *ISLE* laboratories are not “verification” labs. They are naturally integrated into *ISLE* learning process and in addition to helping students develop and test physics concepts and relations, they focus explicitly on helping students develop scientific abilities (students develop these abilities in the context of learning new material). In labs students have an opportunity to collect data that they later analyze, or to test explanations of the patterns in the data that they constructed in large room meetings, or to apply tested concepts to solve practical problems. The *ISLE* laboratories are less prescriptive than traditional ones and have a non-cookbook format (see the set of lab handouts at <http://paer.rutgers.edu/scientificabilities>). Students work in groups to design their own experiments. They then evaluate the results of the experiments and suggest improvements in their designs. They often need to devise at least two independent experimental methods to solve a problem. Materials (lab handouts) given to the students during *ISLE* labs do not contain recipe-like instructions on how to perform the experiments but instead guide students through various aspects of a typical experimental process (Etkina, Murthy and Zou, 2006). The handouts ask students to think about different ways to achieve the goal of the

experiment, to draw a picture of the arrangement of the equipment that they plan to use, and to describe the mathematical procedure they will apply. In addition, the handouts guide them in recognizing additional assumptions they make, identifying sources of experimental uncertainty and evaluating their effects. To facilitate student self-assessment *ISLE* labs use scientific abilities rubrics described above. The rubrics assist students in their work and help them write lab reports (Erkina et al., 2006). Usually students are asked to focus on a selection of 3 to 4 different rubrics in each lab.

The general philosophy of the labs is based on the “preparation for future learning” concept by Bransford and Swartz (1999). Students, working in groups, need to struggle with the ability first, making sense of it, then practiced it many times continuously reflecting on the process, and finally contrasted it with other similar abilities. The example of a metacognitive reflection can be seen in the following part of the lab handout where students have to design an experiment to test whether objects always move in the direction of the unbalanced force or change their motion in this direction: *“First, think of the two competing ideas that you need to test. Think of how you can use the available equipment to design experiments relevant to both of them. Also, think what the words “test an idea” mean in real life. Does “testing” mean trying to prove or trying to disprove an idea? When you come up with possible experiments, call your instructor. After the discussion with the instructor, record what experiments you are going to perform.”*

To address the “time for telling” moment – when the instructor or the lab handout provide a summary of a new ability, the instructor discusses particular ability or experiment with the students in a lab following the one where students used a particular ability first and was based on the instructor’s reading and providing feedback on the reports.

### **Description of the study**

*Population* The study was conducted in the first (fall) semester of an introductory physics course for science majors at a major US public university (the total course enrollment was 193; the number of students attending various activities varied through the semester). There were two 55-min lectures, one 80-min recitation, and a 3-hour lab per week. There were two midterm exams and one paper-and-pencil final exam and final lab exam. All students learned through the same *ISLE* approach in large room meetings and in smaller recitations. The lab sections were split into two groups: design labs (4 sections) and non-design labs (4 sections). Students

registered for the sections in March of the previous academic year. In the previous years we found no difference in performance of lab sections on exams, thus we can assume that during the experimental year the student group distribution was random. During the semester, students were not informed about the study. At the end, we disclosed the procedure and students signed a consent form allowing us to use their work for research.

To make sure that the design group and non-design group were equal in learning ability, we administered Lawson's test of hypothetico-deductive reasoning in the first lab session (Lawson,1978). Coletta and Philips (2005) found that student's learning gains are strongly correlated with their scores on this test. Our lab sections were statistically the same. To ensure that the treatment was the same too, we used the same three instructors to teach the labs. Two of the instructors taught one design and one non-design section and the third instructor taught two of each. All instructors were members of the PER group, highly skilled in the interactive teaching.

*Experimental group: Design labs* (4 sections) Students in the experimental group had *ISLE* design labs described above. They had to design their own experiments. The scaffolding was provided through handout questions that focused their attention on the elements of the scientific process: representing the situation, deciding on the experiment, analyzing experimental uncertainties, etc. Students used self-assessment rubrics to help them write lab reports. A sample handout for one lab experiment is provided in the Appendix. The instructors did not help students design experiments and when students had difficulties, they asked questions and provided hints but did not answer students' questions directly.

At the end of each experiment students had to reflect on the purpose of the experiment, its relationship to their everyday experience, and its place in an overall scientific process. Lab homework that students did after each lab contained reading passages with reflection questions. Student had to analyze stories about historical developments of several scientific theories and applications such as the nature of AIDS, prophylactics, and pulsars. They had to identify the elements of scientific inquiry that are present when scientists answer new questions or apply knowledge. The purpose of the passages was again to help students reflect on the common elements of a scientific investigation.

*Control group: Non-design labs* (4 lab sections) Students in the control group used the same equipment as in design labs and performed the same number (sometimes even more)

experiments. The lab handouts guided them through the experimental procedure but not through the mathematics. Students had to draw force diagrams, energy bar charts, and other representations to solve experimental problems but they did not need to think about theoretical assumptions – these were provided to them in the text. These non-design labs had homework as well—mostly physics problems that prepared students to do the next lab. The instructors taught the labs differently. They provided an overview of the material at the beginning of the lab and then later if students had questions, they answered these questions.

To ensure that students’ and instructors’ behaviors were indeed different in the labs, a trained observer used the method described by Karelina and Etkina (2007) to keep track of the time spent by a group of students on different activities. The observer sat with a group of students for a 3-hour lab timing recording everything that students did. Students’ behaviors were then coded using a coding scheme described in Karelina and Etkina (2007) which, in turn, was based on the work of (Lippmann et al. 2002 and Lippman Kung, Danielson and Linder, 2005). The coding scheme had 5 codes: making-sense, logistic, writing, instructor help, and off-task (see table I). During sense making episodes students are talking to each other, working on figuring out the answer, and holding a coherent conversation. During the logistic mode students gather equipment, operate equipment, collect data, read, and write. An off task mode involves the time intervals when students are not directly engaged in the lab task.

The observer was trained during 4 lab sessions with the researcher who participated in the devising and validating of the coding scheme. After they achieved a 84% agreement on the codes before the discussion and 100% after the discussion. Then the observer began observing the lab groups by himself.

**TABLE I. Codes for observations of lab behaviors**

<b>Making sense</b>	Discussions about physics concepts, experimental design, the data, and the questions in the write-up.
<b>Writing</b>	Describing the experiment, recording data, calculating the values, and explaining the results
<b>Procedure</b>	Gathering equipment, mounting set-up, and taking data.
<b>Instructor (TA) help</b>	Listening to the instructor who was explaining and answering their questions (non-design group) or interacting with the students helping them answer their own questions (design group).
<b>Off-task</b>	Any activity that did not relate to the laboratory task.

The observer “timed” one design group and one non-design group each week, observing 20 3-hour labs.

*Assessment of student learning of physics and acquisition and transfer of scientific abilities*

We assessed student learning by their performance three paper-and pencil course exams (2 midterms and one final) and on two transfer tasks. Course exams had a multiple-choice portion and an open ended portion (3 problems per midterm and 5 on the final). During the comparison, the score on the Lawson’s pre-test was held as a covariate. Thus the results are for the students matched by their pre-test score.

*Transfer to Physics* To assess how students transfer scientific abilities to an unfamiliar physics content in the same functional context (classification by Barnett and Ceci, 2002), we developed a lab task where both groups designed an experiment and wrote a lab report. In contrast to regular labs that students performed during semester, this particular task was identical for the experimental and the control groups. The task involved drag force in fluid dynamics. This physics content was not covered in the course. To minimize the spreading of information among the students we developed four similar versions (Appendix). Students were provided some necessary and some redundant information in the lab handout and had access to textbooks and the Internet.

The students performed this task during the lab (3 hours) on week 13 of the semester. Prior to this, they performed 10 labs. The lab sections were spread from Wednesday to Friday. Four experimental sections had labs on Wednesday and Thursday morning; control sections had the lab on Thursday afternoon and Friday morning. Eighty nine students in each group attended the drag force lab. During each lab section the same observer recorded the behaviors of one randomly chosen group. Thus we have eight 3-hour observations for this part of the study.

*Transfer to Biology* The second transfer experiment involved a biology task that was given as the final lab exam for the course in week 14. Both the experimental and the control groups had to design an experiment to find the transpiration rate of a certain species of plant and subsequently to write a report detailing their experimental procedures, calculations and conclusions. The exact text of the assignment is in the Appendix. This particular biology problem was selected because: a) measuring



transpiration is a task simple enough to complete for students with very little plant physiology background; b) students can use multiple measures to determine transpiration rates which gave them some room for inventiveness, evaluation and decision making; and c) students are more willing to accept a biology assignment as a final exam for their physics lab if they perceive that there is a physical basis (evaporation and osmosis) underlying the biological process of transpiration. This last feature of the task as well as the similarity of the contexts may have facilitated the transfer of scientific abilities.

Lab handouts provided definitions of transpiration and humidity and also included a table with saturated vapor density of water as a function of temperature (the course did not cover humidity at all). In addition, the students could consult the internet.

During the practical exam students in each lab section worked in the same group of three or four as they did during the semester. As during the semester, students submitted individual reports for grading. The four experimental sections had the exam earlier in the week than the control sections. Again, the same observer recorded the behaviors of one group in each lab section. The groups were chosen randomly. This yielded another eight 3-hour observations.

When the exam was graded students from both groups received scores that reflected their performance relative to the standards for two different kinds of labs. This was done with the purpose of not punishing students for being in the control or the treatment group. Thus the grades for the groups purposefully did not reflect the difference. After the semester was over, the researchers used the scientific abilities rubrics to code student work.

### **Sources of data for the study**

For the study we collected the following data:

1. All students' scores on Lawson reasoning test before the course started. (Lawson, 1978).
2. Observations of student behavior during labs 1-10 of the semester (20 observations, 10 randomly chosen student groups in the experimental sections and 10 in control sections).
3. Students' rubric scores (for the students in the experimental group) on relevant abilities during the semester based on the rubrics.

4. All students' scores on the lab practical exam on matching problems for both groups.
5. All students' scores on regular exams that included multiple choices and open-ended questions (2 midterms and one final exam).
6. Observations of student behavior during the physics transfer lab and bio transfer lab (8 experimental and 8 control groups).
7. Student rubric scores for the physics transfer lab and bio transfer lab.

### Findings

*Observations of student activities in the labs:* The observer found that students in design labs on average spend more time making sense of the experiment and writing the results (see Table II).

**TABLE II** The average time in minutes that students spent on different activities in the labs: SM-sense making; Writ.- writing; Proc.-Procedure; Rd. –reading; TA – TA help; OT – off task.

Design group							
	Sense Making	Writing	Procedure	Reading	Instructor (TA) help	Off task	Total
Labs 1-10	37	66	24	5	18	8	159
s.d.	10	12	13	1.7	16.0	9.2	25.9
Non-design group							
Labs 1-10	14	41	20	4	17	2	96
s.d.	8.4	15.1	10.7	3.2	12.8	1.4	30.8

The biggest difference between the groups was in sense making. Not only students in the design group spent more time making sense, but within the time spent on sense-making, the distribution of discussion issues was different for the two groups. We coded instances when students discussed the issues of design, the physics concept involved, the mathematical procedure, assumptions inherent in the mathematical procedure, experimental uncertainties, and revisions of the experiment based on the outcome. We found that students designing their own experiments spent the highest percentage of sense-making time discussing issues associated with the design, whereas the non-design group spent most of its sense-making time discussing the mathematical procedure. In

addition, in the non-design labs there was no time spent on the discussions of assumption or uncertainties, as these were described in the lab handout. These findings are very similar to our findings for student behaviors in non-design labs in a different course (Karelina & Etkina, 2007). We believe that they accurately describe how students spend time in traditional introductory labs. With respect to the total time spent in the lab, whereas the design student teams spent close to 3 hr in lab on average throughout the semester, the non-design student teams spent much less time, and this time decreased on average toward the end of the semester. Overall, by the end of the semester the design student teams were spending much more total time on average in the lab and a greater percentage of the total time on sense-making compared to the non-design students. Although the lab was 3 hours long, non-design students chose to leave early.

#### *Acquisition of normative science concepts*

With regard to the normative science concepts that were assessed via multiple choice and free-response exam questions and problems, students in the design and non-design groups performed similarly on both midterms and the final exam: Midterm Exam 1,  $F(1, 182) = 0.25$ ,  $p = 0.62$ ; Midterm Exam 2,  $F(1, 180) = 1.31$ ,  $p = 0.25$ ; final exam,  $F(1, 180) = 0.45$ ,  $p = 0.502$  (to make three contrasts, we used the sequential Bonferroni correction, critical value of 0.017;).

*Acquisition of scientific abilities* We scored the lab reports of the students in the experimental group using relevant rubrics for all 10 labs of the semester. The scores were validated through the following procedure: For each lab three trained scorers independently scored 2-3 students' lab reports using the chosen rubrics. Then they discussed the discrepancies in the scores to make sure that the details of the particular labs are taken into account. Then they scored additional 7-10 randomly chosen lab reports until they achieved an agreement on more than 85% of the given scores (actually for many labs the scorers achieved almost a 100% agreement after the second scoring). Then each rater scored additional 15-17 reports. A deeper description of this part of the study can be found in Etkina et al., 2008, here we only provide the summary of the findings.

*Uncertainties.* In the second laboratory of the semester, 60% of the students were able to identify the sources of the uncertainty in their measurements and calculated values receiving scores 2 and 3 on the relevant rubric. As the semester progressed, students improved on this ability so much that during regular laboratory 10 all students received scores of 2 and 3. However, evaluating uncertainty, specifically determining its value by writing the result as an interval, turned out to be a much more difficult ability to acquire. Students started lower on this ability (about 50% of them received scores 2 or 3 on this ability at the beginning of the semester) but their performance grew steadily; however, by the end of the semester they achieve almost the same level as on the ability to identify sources of uncertainty, however this number fluctuated and depended on the content and the number of experiments in a particular lab. The results show that the number of the students who could write the result as an interval instead of just one number almost doubled over the course of the semester. The final percentage of students who mastered the ability at the level of 2 or 3 was almost 90%.

*Assumptions.* Students started a little lower on this ability – around 40% of them received the scores of 2 or 3 on this ability at the beginning of the semester. Here, again, we see the scores almost double (around 80%) by laboratory 5 and then oscillate around this higher number. The ability to evaluate the effects of assumptions appeared to be a much more difficult ability than to just identify the assumptions. Students started around 35% and continued to improve on this ability till the end of the semester never reaching the maximum percent around which the scores would oscillate at it happened to the two abilities described above.

Overall we can say that the findings indicate that the time that it takes for the students to demonstrate mastery in the exercise of scientific abilities depends on the particular ability. On average, most students need a time interval of around seven weeks to develop the majority of the abilities at an acceptable level as judged by the rubrics. However, some of the abilities necessitate a longer learning time, such as the ability to evaluate uncertainty or the ability to evaluate the effects of assumptions. We observed that after a certain number of weeks, the scores no longer continue to increase at the same rate but reach a plateau; we call this phenomenon saturation. The saturation level is quite satisfactory for all the abilities; in most cases, around 70% - 80% of students demonstrate

a particular ability. Most difficult abilities to develop (such as the ability to describe the role of assumptions) never attained this saturation.

### **Students Performance on Transfer Tasks**

#### Physics transfer task

*Observations of student behavior:* The observations showed that there was a remarkable difference in the behavior of design and non-design students during the drag force lab. First we noticed that the lab took significantly more time for design students. Although the lab tasks were the same, the design groups spent on average about 40 minutes more time in lab room than non-design students. The difference between the lab duration ( $162 \pm 17$  min and  $120 \pm 25$  min) is statistically significant ( $p = 0.038$ ). The main contribution to this difference came from time spent on sense-making discussions. The sense-making lasted about  $52 \pm 10$  minutes in design groups and only  $15 \pm 5$  minutes in non-design groups. This difference is statistically significant with the level of significance  $p = 0.0007$ . The time students spent on other activities was about the same for both groups. There was a slight difference in the time for writing and instructor's help but based on our data we cannot say that this difference is significant.

*General impression:* The difference was not only in the time spent on the task. The quality of work was also different. Below we show two examples of the lab reports of two groups of students: one of the best non-design groups and one of the best design groups.

#### *Non-design lab report (Task: version 2)*

Determine the velocity of the balloon when air resistance and gravitational force are equal

- place the motion detector on a stand
- place the sensor face downward
- place the helium balloon on the floor
- release the balloon as the motion detector collects data
- on the position-time graph find constant slope segment
- repeat twice more
- find the average velocity
- ...determine Reynolds number. You should get a value larger than 10.

- use the equation to solve for drag coefficient ...  $C_d=0.51$
- now repeat this procedure for air filled balloon. Make sure to drop the balloon from the level of the motion detector...
- air filled balloon -  $C_d= 0.61$

Drag coefficient for air and helium are indeed different.

*Design lab report (Task: version 4)*

Part I. We need to know which equation to use based on the Reynolds number... To find the velocity we will have a motion sensor above the helium balloon. The balloon will be released and the motion sensor will measure its upward velocity. *Here is picture of the set-up. The chart is attached*

We took the velocity 3 times and averaged to allow for random uncertainty...

When the balloon is let go the velocity increases until it reaches terminal velocity, here the net force is zero and acceleration is zero.

When balloon is at rest the net force on it is equal to zero too. *Here are two force diagrams for balloon at rest and at terminal velocity.* The buoyant force is always the same. Therefore the drag force is equal to the force of the string attaching the balloon to the scale...  $C_d = 0.43$

Assumptions: balloon travels in straight path, balloon is point particle, cross-section is circle, cross-section is level. *Uncertainties are evaluated: diameter, scale, motion detector and random uncertainty of the velocity.*

Part II. Prediction (*of the speed of the air balloon falling to the ground*)

When the air balloon falls it reaches terminal velocity drag force equals the force of the earth. *Here are two force diagrams for balloon at rest and at terminal velocity ...* We can use the equation ... to get the velocity:  $V= 0.438\pm 0.021\text{m/s}$  (*the final result incorporates uncertainty*)

We will have a motion sensor aimed down and drop a balloon below it. It will record the velocity of the air balloon before it hits the ground. *The student draws a picture here.*

Assumptions: 1. Balloon achieves terminal velocity – otherwise  $F_e \neq F_d$ ; 2.  $Re > 10$  – otherwise  $F_d$  equation is wrong 3.  $C_d$  is the same for air and helium – otherwise calculated velocity will be wrong.

V was measured and averaged over 3 trials (1.476, 1.02, 1.153).  $V=1.216\pm 0.228\text{m/s}$   
The values do not overlap and therefore are not equal. Some assumptions must have been incorrect.

*Scientific abilities rubrics:* Reading of the lab reports revealed the features that made a difference in the performance of two groups. The quantitative analysis of the lab reports supported the general impression on students' performance. There were significant differences in the lab reports of design students and non-design students. Design students demonstrated significantly better scientific abilities than the non-design students.

*Evaluating the effect of assumptions:* Fifty seven design students (more than 60%) received score 2 or 3. This means that they identified relevant and significant assumptions of the theoretical model that they used, whereas only a few non-design students did. Most design students who identified assumptions also evaluated their effect on the result or validated them. Not a single student in non-design section made an attempt to do this.

*Evaluating effect of uncertainties:* During the semester non-design students learned how to identify sources of uncertainties and how to evaluate their effect on the final answer. But only 11 of them (12%) got score 2 or 3 and transferred this skill in the independent experimental investigation. More than 50% of design students evaluated the effect of experimental uncertainties in this lab. The difference between the groups is statistically significant (Chi-square = 30,  $p < 0.001$ )

*Evaluating the result by means of an independent method.* A high score on this rubric is possible only when a student discusses the discrepancy between the results of two methods and possible reasons of this discrepancy considering assumptions and uncertainty. As a result design students demonstrated a higher ability to evaluate the result. About 64 of design students (72%) got score 2 or 3, i.e. discussed the reasons for the discrepancy while in non-design sections only 38 students (43%) did. The difference between the groups is statistically significant (Chi-square = 16,  $p < 0.001$ ).

*Communication:* This ability includes an ability to draw diagrams and pictures, describe details of the procedure, and to explain the methods. The analysis of lab reports shows that more than 60% of design students drew a picture while only 8% of non-design

students did. The difference in student scores on the communication is statistically significant (chi-square = 60.6,  $p < 0.001$ ).

*Understanding of physics:* Our analysis of the lab reports revealed another interesting feature. Students from different sections demonstrated a different quality of drawing force diagrams in spite of the fact that during the semester all students learned to draw force diagrams the same way. In this lab about 22% of non-design students draw incorrect force diagrams, (i.e. mislabeled or not labeled force vectors, wrong directions, extra incorrect vectors present, or vectors missing), while only 2% of design students made a mistake in force diagrams. This difference is statistically significant (Chi-square = 18,  $p < 0.001$ ).

In addition, we analyzed the consistency of different representations in student work (force diagram versus mathematics, a picture versus a force diagram, etc.). We found a difference in the number of students who created inconsistent representations: 22% of design students versus 44% of non-design students ( $p < 0.025$ , chi-square = 7.8).

#### Biology transfer task

*Observations of student behavior* Similar to the behaviors demonstrated during the physics transfer lab, during the biology lab teams of “design students” spent more time completing the same transfer task than the teams of “non-design students”. It took an average of 23.5 minutes more for the design team to finish their reports. However this difference ( $176 \pm 26$  min and  $153 \pm 26$  min) is not statistically significant ( $p = 0.1221$ ). There was a significant difference ( $p = 0.0026$ ) between the time duration that the subjects spent on sense making. It was  $42.75 \pm 9.84$  minutes for design teams and  $19.75 \pm 4.50$  minutes for non-design teams. In addition, design students spent more time writing their reports and less time receiving help from the instructor; however the differences were not significant ( $p = 0.166$  and  $p = 0.061$  respectively).

*Differences in lab reports:* In addition to the differences in the amount of time that the two groups spent on sense making, we found differences in the quality of students’ lab reports. Non-design students’ reports tended to be shorter on average. They included fewer detailed descriptions of the procedures and fewer pictures and diagrams. Moreover, the reports of non-design students rarely contained any explanations of the advantages



and limitations of the methods used, or any justifications for the choice of the approaches and procedures.

*Identifying assumptions and evaluating their effects:* 91% of the non-design students showed no evidence that they had tried to identify the assumptions implicit in their procedure and calculations. Only 6% of the design students were in the same group. We used two rubrics “the ability to identify assumptions” and “the ability to determine specifically the way in which assumptions affect the results” to score two different experiments that students described in the reports. In order to compare the two groups we added the four scores (two per each experiment) and analyzed this aggregate score statistically. [We followed similar procedures when studying the students’ abilities to analyze and minimize experimental uncertainties and their abilities to represent and analyze data.] The difference between the two groups was statistically significant (Chi-square=119.9,  $p < 0.001$ ). More than half of the design students (53.3%) tried to evaluate the effects of the assumptions that they made on the result or they actually validated their assumptions. Not a single student in non-design group even attempted to do this.

*Identifying, evaluating and minimizing uncertainties:* Both groups of students had to evaluate uncertainties during the semester labs. However, the design group had first to identify the uncertainties, evaluate them, and then to figure out how to minimize them. The instructions in the lab handouts in non-design labs included the descriptions of the sources of uncertainty and the minimizing procedures. During the bio practical lab 83.3% of the design students were able to identify correctly most of the uncertainties; 75% of non-design students did not identify any of them. The difference is statistically significant (chi-square=94.49,  $p < 0.001$ ).

*Evaluating the result by means of an independent method:* When conducting experiments to solve experimental problems during the semester, students in both groups were taught that it was important to perform two independent experiments, to compare the results using experimental uncertainties, and to discuss the possible reasons for the difference. However, only 5.4% of the non-design students evaluated correctly the results including a discussion that referred to both uncertainties and assumptions, while 39% of design students did. (Chi-square=42.25,  $p < 0.001$ ).

*Recording, representing and analyzing data appropriately:* Most of the lab reports from both groups received scores of 2 and 3 on this ability for the two experiments. However, design students received a perfect or almost perfect score twice as often as non-design students. The two groups were significantly different (chi-square=28.05,  $p<0.001$ ).

*Communication:* The statistical analysis of student scores on this ability shows that 56% of the non-design students had serious problems describing their experiments while only 17% of the design students did. (Chi-square=41.645,  $p<0.001$ ).

### **Discussion**

This paper described several investigations that were conducted in an introductory physics course for the students who will not have any more physics courses at the university level. We showed that with proper guidance these students develop several important scientific abilities over the course of 5-7 weeks and they later transfer these abilities to new physics content and to biology. We also found that engaging students in experimental design when they sometimes come up with “wrong” solutions and do not practice solving traditional physics problems does not hurt them in terms of the acquisition of normative physics knowledge. However, they benefit significantly in terms of persistence and ability to approach new problems as scientists.

The studies reported in this paper show that students who design their own experiments in a physics lab and engage in activities that focus their attention on the elements of scientific investigation, acquire scientific abilities and are able to transfer them to a new content area in physics and to biology better than students that follow directions in laboratory handouts. Both the learning tasks and the transfer task took place in a very similar context: the same course and the same room but weekly laboratory investigations as opposed to the lab exam. We found that design students were significantly better than non-design students in the ability to identify assumptions and evaluate their effects; the ability to identify the sources of, evaluate the effects of, and minimize uncertainties; the ability to record and analyze data; and the ability to communicate. These abilities were measured by scoring students’ lab reports using the “scientific abilities” rubrics.

During both physics and biology transfer tasks design students spent more time on sense-making (an average of 30 min more than non-design students in both transfer experiments). That is probably why the reports of design students reflected a more thoughtful take on the task, as they contained more explanations, evaluations, and justifications of the procedures that students selected. What is important here that both groups had the same amount of time allocated to the task, but the group with the students previously engaged in design chose to spend all of the time while non-design group chose to leave. This shows that students in the design group developed a higher level persistence in accomplishing the task than the students in non-design group.

We also found that non-design students' reports resembled their lab handouts. They gave step-by-step instructions with scarce explanations, rarely showed their reasoning, and did not try to justify the validity of their methods and procedures. Design students tried to satisfy the usual lab requirements: they described the procedure, drew pictures, explained the reasoning, analyzed data, and evaluated results. The quality of force diagrams and the level of representation consistency indicate that design students paid more attention to physics understanding and logical reasoning during the lab than non-design students. One explanation is that during the semester, design students had to reconcile different aspects of the phenomenon and had to make sense of their activity more often than non-design students. That could lead to the higher scores on the rubric evaluating the ability to communicate.

The above results seem to indicate that the design of experiments promotes a more profound and meaningful approach toward laboratory investigations in a particular physics course and possibly in science in general. This new approach promotes in turn the transfer of scientific abilities because students understand their purpose. For instance, uncertainties are not fastidious drill exercises at the end of every experiment but are instead a requisite needed to arrive at well-founded conclusions. The results of this study have a special relevance since introductory science should *introduce* the practices the scientific community to students. Students need to assimilate the language, methods and quality standards of scientists. The goal of introductory physics courses must be not only to facilitate the learning of physics concepts and their relationships but, equally

important, to teach the process and nature of physics through the students' actual practice of the scientific inquiry.

Design students significantly outperformed non- design students in other scientific abilities such as the abilities to analyze data and the ability to identify theoretical assumptions. During the semester design students learned that it was impossible to evaluate the results of their investigations adequately without considering assumptions and uncertainties. The non-design students did not consider evaluating the uncertainties as an important part of the lab, although it was a routine procedure during the semester.

In summary, we found if students consciously plan, monitor, evaluate and reflect on their actions, transfer occurs.

## **Appendix**

### **Complete text of the physics transfer task: Investigation of the behavior of the balloon**

Equipment available: *a balloon filled with helium, a balloon filled with air, meter stick, measuring tape, stop watch, motion detector, computer, additional resources.*

Version 1: You hold an air balloon and a helium balloon. Design experiments to determine which physical model best explains their motion if you release them: the model with no air friction, the model with viscous flow or the model with turbulent flow.

Version 2: Design an experiment to determine whether a helium-filled balloon and an air-filled balloon have the same drag coefficients.

Version 3: Use the air balloon to determine its drag coefficient. Then predict the speed of the helium balloon when it reaches the ceiling.

In your report describe the experiment, your analysis and judgment so that a person who did not see you perform the experiment could understand what you did and follow your reasoning.

### **Complete text of the biology transfer task: Transpiration rate:**

Conduct two experiments to determine transpiration rate using stem cuttings from a single species of plant. *Available equipment:* water, beaker holding plant cuttings, parafilm, tubing, ring stand, graduated pipette, timers, humidity sensor, cup, cup with hole, scissors, and two droppers.

We thank Alan Van Heuvelen for working with us on the project, David Rosengrant for conducting observations, John Bransford, Jose Mestre, and Joe Redish for their advice in the design of the project, and Michael Gentile for teaching some labs in the course.

References:

- Alberts, B. (2000). Some thoughts of a scientist on inquiry. In J. Minstrell and E. van Zee (Eds.) *Inquiring in Inquiry Learning and Teaching in Science* (pp.3-13), Washington, DC: AAAS.
- Barnett, S. M., & Ceci, S. J. (2002). When and where do we apply what we learn? A taxonomy for far transfer. *Psychological Bulletin*, 128(4), 612-637.
- Black, P., & Wiliam, D. (1998). Assessment and classroom learning. *Assessment in Education*, 5(1), pp. 7-74.
- Bransford, J., Brown, A., & Cooking, R. (Eds.). (1999). *How people learn: Brain, mind, experience, and school*. Washington DC: National Academy Press.
- Bransford, J. D. & Schwartz, D. T. (1999). Rethinking transfer: A simple proposal with multiple implications. In *Review of Research in Education* edited by A. Iran-Bybee, R. W., & DeBoer, G. E. (1994). Research on goals for the science curriculum. In D. L. Gabel (Ed.), *Handbook of research on science teaching and learning* (pp. 357-387). New York, NY: Macmillan.
- Catrambone, R., & Holyoak, K. L. (1989). Overcoming contextual limitations on problem solving transfer. *Journal of Experimental Psychology: Learning, Memory, and Cognition*, 15, 1145-1156.

- Coletta, V. P. & Phillips, J. A. (2005). Interpreting FCI scores: Normalized gain, preinstruction scores, & scientific reasoning ability. *American Journal Physics*, 73(12), 1172-1182.
- Detterman, D. K. (1993). The case for the prosecution: Transfer as an epiphenomenon. In D. K. Detterman & R. J. Sternberg (Eds.), *Transfer on Trial: Intelligence, Cognition, and Instruction* (pp. 1-24). Norwood, NJ: Ablex.
- Etkina, E., Van Heuvelen, A., White-Brahmia, S., Brookes, D. T., Gentile, M., Murthy, S., et al. (2006). Scientific abilities and their assessment. *Physical Review Special Topics: Physics Education Research*, 2, 020103.
- Etkina, E., Murthy, S., & Zou, X. (2006). Using introductory labs to engage students in experimental design. *American Journal of Physics*, 74 (11), 979-986.
- Etkina, E., & Van Heuvelen, A. (2007). Investigative Science Learning Environment – A Science Process Approach to Learning Physics. In E. F. Redish and P. Cooney (Eds.), *PER-based reforms in calculus-based physics*. College Park, MD: AAPT.
- Gick, M.L., & Holyoak, K.J. (1980). Analogical problem solving. *Cognitive Psychology*, 12, 306-355.
- Gentner, D., Loewenstein, J., & Thompson, L. (2003) Learning and transfer: A general role for analogical encoding. *Journal of Educational Psychology*, 95 (2), 393-409.
- Halpern, D.F. (1998). Teaching critical thinking for transfer across domains. *American Psychologist*, 53(4), 449-455.
- Karelina, A. & Etkina, E. (2007). Acting like a physicist: Study of Student approach to experimental design. *Physics Review, Strand Physics Education Research*, 3.

- Lawson, A. E. (1978). The development and validation of a classroom test of formal reasoning. *Journal of Research in Science Teaching*, 15(1), 11-24.
- Lawson, A. E. (2000). How do humans acquire knowledge? And what does that imply about the nature of knowledge? *Science & Education*, 9(6), 577-598.
- Lawson, A. E. (2003). The nature and development of hypothetico-predictive argumentation with implications for science teaching. *International Journal of Science Education*, 25(11), 1387-1408.
- Lippmann, R., & the Physics Education Research Group. (2002). Analyzing students' use of metacognition during laboratory activities. *AREA Meeting (New Orleans, 2002)*. Retrieved February 16, 2007 from [http://www.physics.umd.edu/perg/papers/lippmann/meta\\_lab.pdf](http://www.physics.umd.edu/perg/papers/lippmann/meta_lab.pdf).
- Lippmann Kung, R., Danielson, A., & Linder, C. (2005). Metacognition in the students' laboratory: Is increased metacognition necessarily better. *EARLI symposium* (2005).
- Lobato, J. (2008). When students don't apply the knowledge you think they have, rethink your assumptions about transfer. In M. Carlson & C. Rasmussen (Eds.), *Making the connection: Research and teaching in undergraduate mathematics* (pp. 289-304). Washington, DC: Mathematical Association of America.
- Salomon, G. & Perkins, D. N. (1989). Transfer: Rethinking mechanisms. *Educational Psychologist*, 24(2), 113-142.
- Schwartz, D. L., Bransford, J. D., & Sears, D. A. (2005). Efficiency and innovation in transfer. In J. Mestre (Ed.), *Transfer of learning from a modern multidisciplinary perspective* (pp. 1-52). Greenwich, CT: Information Age Publishing.

# Chapter 2

---

Special aspects



## 2.1 – Addressing the role of mathematics in physics education

---

Organizer

Symposium organized by Prof. Dr. Gesche Pospiech (TU Dresden, Germany)

## Symposium

### Addressing the role of mathematics in physics education

**Organizer:** Prof. Dr. Gesche Pospiech  
TU Dresden, Germany  
gesche.pospiech@tu-dresden.de

#### Introduction

The interrelation between mathematics and physics as most strongly intertwined subjects were since long in the focus of philosophers and researchers. As the "prototype" of science, physics is based on a twofold foundation: on experiments with data on the one hand and on theories, models and quantitative predictions on the other hand (see e.g. Dirac 1939). The interplay of empirical and mathematical elements is most subtle and shall not be discussed here in detail, (see e.g. Kuhn 1976). However, the mathematical description of natural or technical phenomena in its different forms is of high relevance for physics education and as such forms the background of the contributions in the Symposium.

The starting point is that mathematical elements are used throughout physics, from taking data in experiments and representing them, up to systems of differential equations together with their interpretation constituting a theory. All this finds its correspondence with increasing level of abstraction during a physics course at school or university requiring the development of formal thinking with the students on all levels and especially right from the beginning. Accordingly, in this paper by the term "mathematics in physics" we do not only understand formulae, i.e. the algebraic representation, but also graphical representations e.g. of experimental data. In this sense it becomes obvious that mathematics besides its content related role characterizes the physical method and the way of gaining knowledge in physics. In addition, there is consent that in physics education not only the content knowledge should be taught but also the nature of science comprising the processes that lead to new insights and the significance of physical knowledge with respect to the real world, e.g. in the role of models. Concerning the nature of physics the mathematical formulation of physics relations and laws plays a central role, because of the possibility of predicting and its reasoning potential. This leads to the conviction that for an adequate conveyance of physics and even more the nature of physics, an insight into the relationship between mathematics and physics is a necessary element of any course in physics education. The focus of the Symposium was to highlight this educational aspect from different perspectives.

#### Contributions to the Symposium

- (1) **Mathematics in physics: Upper secondary physics students' competency to describe phenomena applying mathematical and graphical representations**  
Øystein Guttersrud, Carl Angell
- (2) **Translating between Mathematics and Physics: Analysis of Pupils' Difficulties**  
Olaf Uhden, Gesche Pospiech
- (3) **Utilising technology to develop a collaborative approach to the teaching and learning of physics and mathematics in second level education in Ireland**  
Jennifer Johnston, Máire Ní Ríordáin
- (4) **Students' use of mathematical representations: solving problems in kinematics**  
Silvia M. Pérez, M. Celia Dibar Ure
- (5) **Mathematics in physics lessons: developing structural skills**  
Ricardo Karam, Gesche Pospiech, Maurício Pietrocola

- (6) **Building quantum formalism in upper secondary school students**  
Alberto Stefanel, Marisa Michelini, Lucio Santi
- (7) **The mathematics as a resource in understanding the peculiar characteristics of magnetic field**  
Stefano Vercellati, Carlo Cecchini, Marisa Michelini, Alessandra Mossenta, Lorenzo Santi
- (8) **The interplay of physics and mathematics in a graduate quantum mechanics course for physics teachers**  
Bat-Sheva Eylon, Elisheva Cohen, Esther Bagno,

### **Theoretical Background**

Analysing the relationship between mathematics and physics from an educational perspective implies that several aspects have to be distinguished, allowing for a didactic reconstruction (Kattmann et al, 1997). In the process of didactic reconstruction the internal logic of subject matter and the learner perspective are being brought together in order to design an appropriate learning path.

In this sense the analysis of the general relation between mathematics and physics as it is seen by physicists, mathematicians and philosophers of science is the basis of any teaching concept. In order to pursue the aim of teaching the nature of science the fundamental and multifaceted role of mathematics in physics has to be carefully analysed. The philosophical viewpoint together with the experimental aspect and the technical role of mathematics have to contribute to providing the students an insight into the whole of physics.

The second aspect in a teaching concept takes into account the starting point of students, their abilities and possible difficulties as well as their interests. Here the practical and the philosophical aspects of mathematics in physics are being mirrored: Students have to cope with the technical tools - graphs and formulae - and they also should develop some insight into the structural role e.g. by interpreting formulae or recognizing analogies in the mathematical formulation of physical laws in different areas of physics.

An analysis along these lines then should lead to suitable teaching-learning sequences.

### ***Relation between Mathematics and Physics - practice and theory***

This broad and vast area we cannot elude in complete detail. Important for our purpose is an analysis of the different functions mathematics can have in physics from an educational perspective. On the basis of a substantial analysis of the philosophical background there were identified - besides the technical role - aspects of the structural role of mathematics relevant for teaching, (Pietrocola 2008). The structuring function of mathematics allows for formulating models of physical processes in a universal language. The resulting predictive power has two aspects: supporting experiments with numerical analysis (numerical predictions) and the finding of new phenomena e.g. by structural predictions. Indeed the comparison of theoretical predictions with experimental results lies at the heart of physics and brings forward research in physics. An insight into this process should make it worth for students to engage in the use of mathematics in physics lessons. The comparison of prediction and experimental outcome is part of scientific inquiry and makes students aware of the nature of physics as an idealizing and modelling science. Stressing the structural predictions enables logical reasoning. As a whole teaching the role of mathematics in physics faces two problems: supporting a functional understanding of a physical law as well as an insight into the general significance of mathematical statements for physics, showing analogies and similarities between different areas of physics. The first aspect also includes the practical use of mathematics in thoughtful calculating, arriving at simple quantitative results or in the interpretation of graphs. Apart from theoretical considerations physicists

use mathematical elements in a very pragmatic manner. Also this aspect is not to be neglected: students may develop interest in the possibility of quantitative predictions yielding interesting, possibly everyday related results (Pospiech, 2009).

On the other hand, mathematics also serves as a communicative means (Krey 2009), be in graphs or by formulae which uniquely establish a physical law. The mathematical elements represent a universal footing on which a physics discussion can take place and which gives students a concrete basis for understanding.

### ***Role of mathematics in physics education - the learner perspective***

Besides the statements that mathematical elements are important for physics and the general idea that mathematics seems to constitute an additional difficulty for students there are only few studies highlighting precisely the ways students use and think about mathematics in physics (see e.g. Sherin 2000). In the last years physics education research focussed on conceptual understanding and on establishing promising methods for better and more effective teaching. One important aspect was the thorough understanding of physical concepts as e.g. force, energy, heat or the particulate model of matter. In this connection the mathematical elements graphs and formulae played a very different role. Whereas graphs were considered an important tool for depicting experimental data and evaluating them, a focus on formulae was considered as hiding physical relations because the students normally just plug in numbers. Furthermore, teachers often complain that students do not have sufficient mathematical abilities in order to handle the physical equations. Besides those general assumptions readily made by teachers on all stages there is only few research on the precise nature of the observed difficulties and nearly nothing about possible causes with school students. Most studies about problem solving in physics analyse the proceeding of college students and there are only a few studies about the graphical abilities of children from primary school (e.g. Hardy et al. 2005). The strategies in physical problem solving followed by university students were analysed by Tuminaro (2007), who identified six different so called "epistemic games" of different complexity.

In the following we will describe the different research results presented during the Symposium and show how they contribute to the answering of the research aims.

### **Research Perspectives of the Symposium**

Both described aspects of the didactic reconstruction define research desiderata. On the one hand the overall goal is to analyse in more depth central aspects of the mathematical constructs in physics as a basis for constructing a learning path way. On the other hand the learner perspectives of different age groups need a thorough analysis. In the following we define four questions and describe how the contributions to the symposium fit into the outlined framework and which questions they address.

### ***Can the structural role of mathematics be conveyed?***

The ultimate goal is that students understand the interrelationship between mathematics and physics as deeply as possible. Beyond the technical aspects such as doing concrete calculations they should acknowledge the role of mathematics as the language of physics as it shows itself e.g. in analogies or in similar mathematical formulations in different areas. Therefore they have to learn the structural role at several examples. This seems quite an ambitious aim in a school physics course. But in university courses this aspect gains much importance. Karam (**contribution 5**) analyses in his paper how a distinguished university teacher stresses the structural role of mathematics in physics at the example of electrodynamics and special relativity. In these lectures there can be identified different key techniques of clarifying to students the roles of mathematical tools in physics, its powers

and its limits. The pattern of different aspects of mathematization should shed light onto an optimal teaching strategy.

An example for the interplay of fundamental mathematical structures and their implications for physical understanding beyond simple description is carried through with the example of the magnetic field by the group from the University of Udine (**contribution 7**). The transformation properties of so-called axial and polar vectors give rise to a deep lying clarification.

Both aspects, understanding in great detail the mathematical-physical structure of the problem at hand and the careful development of formal thinking with students go hand in hand. This leads to the second question.

### *Is constructive interference possible in mathematical-physical understanding?*

One of the main questions is whether mathematical understanding can foster physical understanding. In the constructivist perspective of physics education students have to see many examples of any new concept they learn. This principle should also apply to the use of mathematics in physics problems. Hence the hypothesis follows that in order to achieve a positive influence on understanding the explicit combination of physical phenomena and formal reasoning has to be a central feature.

An example is presented by Stefanel in **contribution 6** in connection with a unit on quantum physics. This unit is constructed to help the students to better understand the implications of simple experiments and to give their interpretation a concrete underlying meaning with the introduction of a mathematical formalism. Here, the mathematical formulation supports the building of an understanding of the abstract quantum physical phenomena. In working with formula always the connection to the experimental results is being stressed.

On the level of teacher education the interplay between mathematical formalism and conceptual understanding and their respective powers and limitations was exploited in a course on quantum theory for in-service teachers, described by Eylon and Bagno (**contribution 8**). It became obvious that in a teacher course any mathematical formalism has to have a strong background by relating the formal aspects to the physical concepts lying behind. Under such circumstances it can further the understanding of physical concepts.

A suitable strategy for constructive interference seems to lie in integrating mathematics and physics courses. However, because of their different perspectives this can not be accomplished throughout. Therefore suitable opportunities should be used, (Rath, 2006).

### *Which role do different representations in their interplay have?*

The physical description of the world relies on models which have been found in an process of abstraction and idealization from reality. Hence every real physics problem has to be translated into the model world of physics with its concepts. On the way normally different representations are used, which also seem to play a central role for a physics understanding. The possible representations range from iconic representations through graphical representations up to abstract algebraic representations, the formulae, which then have to be interpreted. As expert physicists use different representations in the solution process of a problem and change fluently between them adapting to their needs, the question arises to which extent students use representations, how they change between them and whether proper teaching could enhance their use.

As the first steps are important for the further development of mathematical-physical abilities, as pointed out in (Pospiech, 2006), in the view of gradually developing the students' abilities it appears to be promising to implement the use of different representations quite early. A very interesting example was presented by Johnston et al (**contribution 3**). They developed a short teaching sequence for introducing the physical quantity velocity with a

strong junction of experiment, graphs and formula allowing for visualizing the relations and engaging the children into the development of the concept. That the formula only arises in the last step is quite important: First the meaning of the physical concept has to be fixed before the abstract formula can help in being more precise. This also seems a good example for a careful joint planning of mathematics lessons with physics lessons in order to have a good benefit. To make the mathematical relations visible and show concretely their physical meaning seems a crucial point for understanding physical concepts.

A big study about the representational abilities and their possible development on high school level through a modelling approach has been performed in Norway by the group of Angell (**contribution 1**). It could be shown that all the possible different representations of physical relations play a central role and are important steps towards mathematisation.

All these results show that further studies to deepen the understanding of thinking processes of the students on different levels are necessary.

### ***Which are the central difficulties students encounter?***

Often it is said, that at the heart of the students' difficulties there are mostly technical skills mainly concerning handling terms and units. However, often the same students perform better in mathematics lessons at the same procedures. So we ask in which way exactly these difficulties arise and whether there is perhaps (destructive) interference of mathematical and physical difficulties. There are only few and restricted studies addressing this relation, (e.g. Redish 2005), concentrating on university students. We know of no study analysing in detail how students at school proceed while connecting mathematics and physics in quantitative physics problems.

The first results of a study describing how students are performing who already have some experience with mathematical elements in physics and which difficulties they encounter on their way is presented by Uhden (**contribution 2**). His descriptive study closes an important gap because it enhances the knowledge of mathematical-physical abilities of 15 - 16 year old students. This study furthers the understanding of the thinking of students and gives more concrete hints of how to embed mathematical elements in secondary physics education.

Perez et al (**contribution 4**) studies the interplay of physical and mathematical elements at an important problem embedded into an everyday context (acceleration and force). She identifies the strategies university students take in the solution process with a focus on the use of representations and meta-cognitive skills. Besides some expected solving steps she finds also unexpected arguments of students hinting to typical strategies.

### **Conclusion**

The Symposium was a step forward to bring together people from different countries attacking these problems. It showed that there are many approaches into this complex area which were linked together during the symposium. It became obvious that only the very detailed analysis of learning and teaching, which recently has begun, can lead to a fruitful use of mathematical elements in physics education. To develop and evaluate appropriate strategies for teaching will be one of the next big tasks.

### **References**

- Dirac, P. A. M. (1939). *The relation between mathematics and physics*. Lecture given on presentation of the James Scott Prize, February 6, 1939. Published in: *Proceedings of the Royal Society (Edinburgh)*, Vol. 59, 1938-99, Part II, 122-129.
- Hardy, I., Schneider, M., Jonen, A., Möller, K., & Stern, E. (2005). *Fostering diagrammatic reasoning in science education*. *Swiss Journal of Psychology*, 64, 207-217.
- Kattmann, U., Duit, R., Gropengießer, H. & Komorek, M. (1997). *Das Modell der Didaktischen Rekonstruktion - Ein Rahmen für naturwissenschaftsdidaktische Forschung und Entwicklung*. *Zeitschrift für Didaktik der*

- Naturwissenschaften 3(3), 3-18.
- Krey, O, Mikelskis, H (2009). *Zur Rolle der Mathematik in der Physik aus Sicht von Lehramtsstudierenden*. In: Höttecke, D. (Hrsg). Chemie- und Physikdidaktik für die Lehrerbildung. Gesellschaft für Didaktik der Chemie und Physik. Jahrestagung in Schwäbisch Gmünd 2008. Münster: LIT-Verlag, 167-169
- Kuhn, T. S. (1976), "Mathematical vs Experimental Tradition in the Development of Physical Science", *Journal of Interdisciplinary History*, 7, 1-31, 1976.
- Pietrocola, M. (2008). Mathematics as structural language of physical thought. In: Vicentini, M. and Sassi, E. (org.). *Connecting Research in Physics Education with Teacher Education* volume 2, ICPE – book.
- Pospiech, G. (2006). *Promoting the competence of mathematical modeling in physics lessons*. In van den Berg, E., Ellermeijer, A.L., Slooten, O. (Eds.) *Modelling in Physics and Physics Education* (pp 587-592). Amsterdam:AMSTEL Institute, University of Amsterdam.
- Pospiech, G. (2009). *On Understanding, Explaining and Mathematical Formulation of Physical Problems in Secondary School*. In: GIREP-EPEC Conference *Frontiers of Physics Education*, 26-31 August, 2007, Opatija, Croatia : Selected Contributions. Rijeka:Zlatni rez.
- Rath, G (2006). *Auseinandergelebt? - Probleme und Lösungsansätze zur Koordination von Physik und Mathematik an höheren Schulen*. Plus Lucis, 1-2, 9-13.
- Redish, E. (2005). Invited Talk. *Problem Solving and the Use of Math in Physics Courses*. Proceedings of ICPE Delhi 2005.
- Tuminaro, J; Redish, E F. (2007). Elements of a cognitive model of physics problem solving: Epistemic games *Phys. Ed. Res.* 3, 020101.

# Mathematics in physics: Upper secondary physics students' competency to describe phenomena applying mathematical and graphical representations

Øystein Guttersrud<sup>1</sup>  
oystein.guttersrud@fys.uio.no

Carl Angell<sup>2</sup>  
carl.angell@fys.uio.no

<sup>1</sup>Norwegian Centre for Science Education, University of Oslo, Norway

<sup>2</sup>Department of Physics, University of Oslo, Norway

## Abstract

Physics, more than the other sciences, tends to use modelling as a research tool. Contemporary physics research is basically concerned with developing and improving mathematical models, from the atomic nucleus to the universe. Developing and comprehending models of physical phenomena involves working with multiple representations as conceptual, pictorial, graphical and mathematical representations.

Based on data from an achievement test assessing students' ability to describe phenomena using among others graphical and mathematical representations, we empirically derived benchmark descriptions of physics students' mathematical modelling competency. By using a questionnaire and focus group interviews we further investigated students' ideas about and their experiences with mathematical and graphical representations in physics.

## Introduction

It may be argued that physics, more than the other sciences, tends to use modelling as a research tool. Within many branches of current physical sciences, research is essentially about developing and improving models – usually formulated in mathematical language – describing phenomena such as climate, the atomic nucleus, or the universe (Chonacky, 2006; Gilbert, 2004; Winsberg, 1999). *Models* and *modelling* consequently receive increasing attention from the science education community as important components of a contemporary science education (e.g. Gilbert, 2004; Gilbert & Boulter, 2000; GIREP, 2006; Greca & Moreira, 2002), both because it reflects the nature of physics and because modelling activities are considered useful for learning physics concepts and processes (see also Hestenes, 1987, 1996; Wells, Hestenes, & Swackhamer, 1995).

Physics has a long tradition for being regarded as a particularly difficult school subject (Angell, et al., 2004; Carlone, 2003; Osborne & Collins, 2001). We have argued (Angell, et al., 2008; Guttersrud, 2008) that physics appears difficult because it requires students to cope with multiple representations and to manage the translations between these (Dufour-Janvier, Bednarz, & Belanger, 1987). In a project (PHYS 21) in Norwegian upper secondary school, we applied a conceptualisation of working with physics in terms of *multiple representations*. The aims of the PHYS 21 project were to strengthen the use of different forms of representations, accentuate scientific reasoning in relation to experimental results and highlight the relationship of mathematics and physics in physics education (Angell, et al., 2008; Guttersrud, 2008).

The aims of this paper are to explore students' ability to describe phenomena using graphical and mathematical representations, and empirically derive benchmark descriptions of physics students' mathematical modelling competency.



## Methods

Developing physics students' mathematical competency includes developing their skills to describe phenomena employing a range of different representations as e.g. mathematical and graphical representations and their analogous and analytic reasoning skills. We therefore deduced that assessing physics students' mathematical modelling competency means to assess students' reasoning skills and abilities to interchange between representations of physical phenomena. The different forms of representation and reasoning processes assessed are described in figure 1:

Figure 1: The forms of representation and reasoning processes assessed.

### Forms of representation assessed

Representation	Description
Conceptual	Conceptual representation deals with the concepts used to describe phenomena inclusive verbal descriptions making the scientific meaning available in the classroom.
Mathematical	Mathematical representation includes equations and mathematical operations on these.
Graphical	Graphical representation refers to graphs and other descriptive representations of variables.
Experimental	Experimental representation refers to all practical approaches.
Pictorial	Pictorial representation refers to all kinds of iconographic descriptions except graphs.

### Scientific reasoning processes assessed

Type	Process	Description
Analogous	Categorize	Categorize diagrams, experiments and type of experimental error in relation to information provided.
	Identify/apply	Identify shared properties of physics formulas (e.g. linearity). Apply knowledge and general mathematical expressions to describe physical phenomena. Plot experimental data.
Analytic	Decide	Select from alternative solutions and explanations with respect to empirical data and evidence provided.
	Evaluate	Evaluate scientific claims with respect to empirical data and evidence provided.
	Conclude and communicate	Draw and communicate valid science-based conclusions anchored in empirical data and evidence provided. Make and communicate scientific explanations to justify solutions.

The *achievement test* items, assessing students' mastery and proficiency in the modelling area, were accordingly developed to assess interchange between one pair of representations and one of the reasoning processes. The two dimensions were merged into one scale reporting on physics students' mathematical modelling competency. A field trial had been conducted to ensure test items' psychometric qualities.

Using "scale anchoring" (Beaton & Allen, 1992), criterion-referred benchmark descriptions were developed. As suggested by Forsyth (1991) four benchmarks or anchor levels corresponding to the 90th, 75th, 50th and 25th percentiles of achievement, were selected. These correspond to the top 10%, the upper quarter, the top half (median) and the lower quarter of the students assessed.

The *questionnaire* surveyed students' perception of the use of multiple representations during physics lessons.

The *focus group* study explored students' meta-perspectives on “model and reality”, experiences with employing representations during modelling experiments and their views of hypotheses, laws and theories.

### Population and sample size

Physics is an optional subject in upper secondary school in Norway. Our target population was second year physics students (17/18-year-olds).

A total of 446 students from 15 schools (37 % females) responded to the achievement test and questionnaire. Using two single-gender focus groups at each of three schools, 30 students (50 % females) were interviewed.

### Results

The benchmark descriptions developed (figure 2) suggest that 29% of the students assessed seem to possess analytic reasoning skills (students who perform at or above benchmark 3). Only 13% of the students assessed seem to be able to describe phenomena employing quadratic mathematical expressions (students who perform at or above benchmark 4). A more serious problem is that 43% (students who perform below benchmark 2) seem to have problems describing phenomena employing first order expressions.

Based on our benchmark descriptions we may assert that students at or above benchmark 3 (29% of students assessed) possess central reasoning processes and abilities to cope with multiple representations, while students below benchmark 2 (43% of students assessed) have incomplete skills in mathematical modelling as assessed by the achievement test developed.

Figure 2: Benchmark descriptions of mathematical modelling competency

<b>4</b> <b>Advanced</b>	Possess skills to read the scientific story enclosed in <i>quadratic</i> equations (physics formulas) and know how the constants $a$ and $c$ in the general expression $y = ax^2 + bx + c$ determine the shape of the parabola. Are able to assign variables and general constants in <i>first</i> order expressions a physical interpretation.
<b>3</b> <b>High</b>	Possess analytic reasoning skills and abilities to link constant physical quantities to horizontal lines in diagrams. Are able to <i>explain</i> , based on uncertainty in measurements (error bars), which line best fits a set of experimental data plotted into a coordinate system.
<b>2</b> <b>Intermediate</b>	Are able to relate general <i>constant</i> expressions ( $y = a$ ) to horizontal lines in diagrams and read the scientific story enclosed in <i>first</i> order equations (physics formulas). Possess skills to export a set of experimental data into a coordinate system and plot dependent (effect) as a function of independent (cause) variable. Are able to select, from a list, which experiments to collate to test a given hypothesis.
<b>1</b> <b>Low</b>	Possess analogous reasoning skills and abilities to relate general first order mathematical expressions ( $y = ax + b$ ) to sloped lines. Are able to operate in the abstract world.

*Questionnaire* items assessing the use of different forms of representation during physics lessons indicate that different representations of physical phenomena more often appear “isolated” than connected into “holistic ideas”, and that the practice of paying attention to students' own intuitive ideas varies more across classrooms than the attention drawn to the “correct scientific ideas” – the scientifically correct representations.

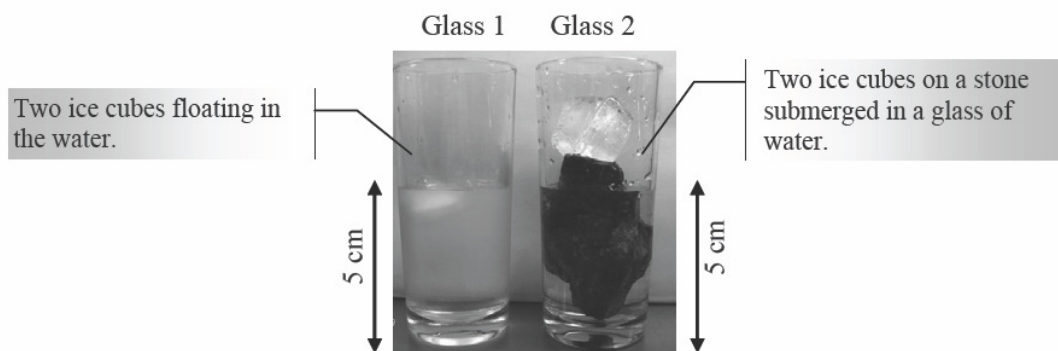
As it seems to be a great unexploited potential in building scientific stories in interplay between representations, a lot of students may consequently be left with unconnected, unstructured and hence unstable sets of representations or “pieces of knowledge” (diSessa, 1993). Students may hence be less able to comprehend and make use of the scientific model taught.

### Example from the achievement test

Some students wanted to study how the melting of ice around The South Pole and in the areas around The North Pole influences the sea level.

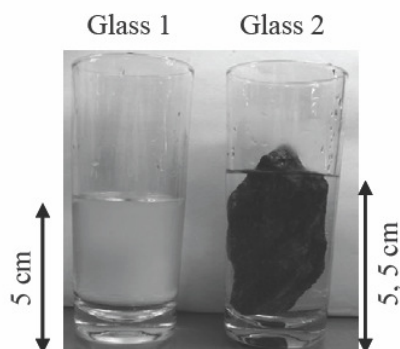
The students filled a glass (Glass 1) with water. When they put two ice cubes into the glass, the water level was 5 cm. The students put a stone into an identical glass (Glass 2). They put two ice cubes on top of the stone and filled the glass with water until the water level was 5 cm there as well.

At the North Pole there is no land under the ice, but at The South Pole there is. The stone represents these territories. Glass 1 thus represents with that The North Pole, while Glass 2 represents The South Pole.



The picture below was taken after the ice cubes had melted:

### AFTER MELTING



## Question 1

Assume that the ice is melting with a constant rate. Which mathematical expression describes the water level ( $y$ ) in glass 1 and glass 2 while the ice melts?

- A Glass 1:  $y = b$ , Glass 2:  $y = ax + b$
- B Glass 1:  $y = ax + b$ , Glass 2:  $y = b$
- C Glass 1:  $y = b$ , Glass 2:  $y = ax$
- D Glass 1:  $y = ax$ , Glass 2:  $y = b$

## Question 2

What does the  $x$  in the expressions in the previous question refers to?

- A The melting speed of the ice
- B The original water level in the glass
- C The temperature of the water in the glass
- D The time from the ice began to melt

Question 1 assessed students' ability to interchange between experimental and mathematical representations of the phenomenon. As many as 68 % answered correctly.

Question 2 was much harder. Less than 40 % answered correctly. However, as a majority of students performing at level 4 answered correctly, and a majority at level 3 *did not*, the item "anchored" at level 4. This item describes what students at the highest level typically are able to do. A student performing at a lower level is *most likely* to fail on the item.

Results from the questionnaire show that almost one third responded that they never or seldom study relations between mathematical and graphical representations of physics formulas. More than half responded that they never or seldom derive physics formulas from graphs describing empirical data – activities we interpret as modelling activities. Furthermore, most students responded that they had investigated how the graphs corresponding to first and second order general mathematical expressions looked like, but almost one fourth responded that they never had investigated how manipulation of the constants  $a$ ,  $b$  and  $c$  affects the shape and orientation of the parabola.

Students stated, when *interviewed*, that they did not find it particularly difficult to plot experimental data sampled during practical modelling activities into a coordinate system. However, determining the general mathematical expression best describing the experimental data – constructing a physics formula from the best fit graph – was perceived a quite difficult task.

## Discussion and conclusions

As students proficient at benchmark 3 and 4 seem to possess central reasoning processes and abilities to handle different forms of representation, we see it as a goal to make more students proficient at least at benchmark 3. This would imply developing students reasoning skills to an "analytic" level and their abilities to interpret "the semantics of physics formulas". We believe that emphasizing the connections between mathematics and physics by focussing on acquaintances between the general mathematical expressions  $y = ax + b$  and  $y = ax^2 + bx + c$  on one hand and physics equations like  $F = ma$  and  $s = v_0t + \frac{1}{2}at^2$  on the other is crucial.

Scientific concepts represent, especially in the case of physics, the vocabulary of a unique language: the language of nature – mathematics. The concepts create meaningful "sentences" which many students find hard to grasp: the equations. Equations, physical laws, "formulae", or "mathematical representations of physical phenomena" are icons of our knowledge about the nature, but may appear as semantically blind general mathematical expressions to students

with weak conceptual understanding. A mathematical view of the world is intrinsic to physics and mathematical models put demands on students for understanding mathematics (Erickson, 2006; Oke & Jones, 1982a, 1982b).

Students solving practical tasks tend to work in either a mathematical mode or a physical mode (Erickson, 2006) and find it hard to e.g. allocate mathematical symbols a physical interpretation. Students may effortlessly identify the “interception” and “slope” in linear equations working in a mathematical mode ( $f(x) = ax + b$ ), but find it problematic when occurring in a physics formula ( $s = s_0 + v_0t$ ). Bagno, Berger, & Eylon (2008) found that many students fail to relate between a formula and its physical meaning, and to identify the formula's conditions of applicability.

School physics has a strong relationship to mathematics. However, the mathematics used even in upper secondary school physics is not very advanced. The physics curriculum in many countries includes only relatively simple arithmetic and algebra. However, the achievement test in TIMSS Advanced 2008 documented that for example Norwegian and Swedish students have noteworthy weak skills in manipulating algebraic expressions and equations, and that they only to a small extent can deal with fundamental quantitative concept in physics (Lie, Angell, & Rohatgi, 2010).

It is obvious that more needs to be done to identify efficient ways of teaching the mathematical modelling aspect of physics to students. We believe that physics teaching should put more emphasize on 1) interchanges between mathematical expressions (formulas) and the shape of the corresponding graphs, 2) physical interpretations of mathematical expressions (e.g. constants and variables of formulas), and 3) introducing physics formulas through mathematical modelling processes (teacher directed practical activities where students develop formulas from graphs fitting empirical data).

## References

- Angell, C., Guttersrud, Ø., Henriksen, E. K., & Isnes, A. (2004). Physics: Frightful, But Fun. Pupils' and Teachers' View of Physics and Physics Teaching. *Science Education*, 88, 683 - 706.
- Angell, C., Kind, P. M., Henriksen, E. K., & Guttersrud, Ø. (2008). An empirical-mathematical modelling approach to upper secondary physics. *Physics Education*, 43(3), 256-264.
- Bagno, E., Berger, H., & Eylon, B. S. (2008). Meeting the challenge of students' understanding of formulae in high-school physics: a learning tool. *Physics Education*, 43(1), 75-82.
- Beaton, A. E., & Allen, N. L. (1992). Interpreting Scales Through Scale Anchoring. *Journal of Educational Statistics*, 17(2), 191-204.
- Carlone, H. B. (2003). Innovative science within and against a culture of "achievement". *Science Education* 87, 307-328.
- Chonacky, N. (2006). Has computing changed physics courses? *Computing in Science & Engineering*, 8(5), 4-5.
- diSessa, A. A. (1993). Toward an epistemology of physics. *Cognition and Instruction*, 10(2 & 3), 105-225.
- Dufour-Janvier, B., Bednarz, N., & Belanger, M. (1987). Pedagogical Considerations Concerning the Problem of Representation. In C. Janvier (Ed.), *Problems of representation in the teaching and learning of mathematics* (pp. 109-122): Hillsdale: Lawrence Erlbaum.
- Erickson, T. (2006). Stealing from physics: modeling with mathematical functions in data-rich contexts. *Teaching mathematics and its applications*, 25(1), 23 - 32.
- Forsyth, R. A. (1991). Do NAEP Scales Yield Valid Criterion-Referenced Interpretations? *Educational Measurement: Issues and Practice*, 10(3), 3-16.

- Gilbert, J. K. (2004). Models and modelling: Routes to more authentic science education. *International Journal of Science and Mathematics Education*, 2, 115 - 130.
- Gilbert, J. K., & Boulter, C. (Eds.). (2000). *Developing Models in Science Education*. Dordrecht: Kluwer.
- GIREP (2006). Modelling in Physics and Physics Education Retrieved 19.12, 2007, from <http://www.girep2006.nl/>
- Greca, I. M., & Moreira, M. A. (2002). Mental, Physical and Mathematical Models in the Teaching and Learning of physics. *Science Education*, 86, 106 - 121.
- Guttersrud, Ø. (2008). *Mathematical Modelling in Upper Secondary Physics Education. Defining, Assessing and Improving Physics Students' Mathematical Modelling Competency*. Unpublished Ph.D thesis, University of Oslo, Department of Physics, Oslo.
- Hestenes, D. (1987). Toward a modeling theory of physics instruction. *American Journal of Physics*, 55(5), 440 - 454.
- Hestenes, D. (1996). Modeling Methodology for Physics Teachers. Retrieved from <http://modeling.la.asu.edu/modeling/MODELING.PDF>
- Lie, S., Angell, A., & Rohatgi, A. (2010). *Fysikk i fritt fall? Physics in free fall? (in Norwegian)*. Oslo: Unipub.
- Oke, K. H., & Jones, A. L. (1982a). Mathematical modelling in physics and engineering - part 1. Physics Education. *Physics Education* 17(5), 220-223.
- Oke, K. H., & Jones, A. L. (1982b). Mathematical modelling in physics and engineering - part 2. *Physics Education*, 17(6), 271-273.
- Osborne, J., & Collins, S. (2001). Pupils' views of the role and value of the science curriculum: a focus-group study. *International Journal of Science Education*, 23(5), 441-467.
- Wells, M., Hestenes, D., & Swackhamer, G. (1995). A Modeling Method for high school physics instruction. *American Journal of Physics*, 63(7), 606 - 619.
- Winsberg, E. (1999). Sanctioning models: The epistemology of simulation. *Science in Context*, 12(2), 275-292.

# Translating between mathematics and physics: Analysis of student's difficulties

Olaf Uhden

olaf.uhden@tu-dresden.de

Gesche Pospiech

gesche.pospiech@tu-dresden.de

Department of Physics, Technische Universität Dresden, Germany

## Abstract

Besides learning physical concepts and scientific methods it is also important to reflect the reality of physics as a science where mathematics and physics are closely intertwined. On the other hand, an understanding of the physical concepts forms the basis upon which new physical knowledge can be established. If one knows in detail the difficulties experienced by students during the translation process between mathematics and physics, one can decide how mathematics might be supportive and develop new teaching strategies that help to overcome their problems. In order to do so we videotape 15 to 16-year old students while solving special diagnostic tasks which are designed to address the translation process between mathematics and physics. Invited students work in pairs on these tasks and are requested to discuss the problems with each other and get a joint solution. The videos will be analyzed to extract and categorize students' difficulties, their interplay and its effect on the understanding of mathematics in physical context. Preliminary findings suggest that for students physical meaning and mathematical calculations are two different things. Also severe problems in dealing with units and performing mathematics with double fractions can be observed. One reason may lie in the notion of formulas as a mere tool.

## Introduction

*"...it is impossible to explain honestly the beauties of the laws of nature in a way that people can feel, without their having some deep understanding of mathematics."* (Feynman, 1992) There are many other physicists emphasizing like Feynman the deep interrelation between mathematics and physics. It is not the technical toolbox mathematics provides but rather the creative aspect producing new insights into physical structures that hints at a deep conceptual relation between both sciences. Einstein for example states that *"Our previous experience justifies the belief that nature is the realization of the most basic mathematical thoughts. [...] Experience remains certainly the sole criterion of usefulness of a mathematical structure for physics. But the truly creative principle is in mathematics"* (Einstein, 1956, p. 116, our translation). Considering discussions about the importance of "nature of science" for science teaching (Lederman, 1992), it should be obvious that also the interplay between mathematics and physics should be an essential part of science teaching.

Another aspect, which underlines the importance of taking care of mathematical problems in physics education, relates to knowledge transfer. It is amply documented, that transfer does not succeed to the desired extent, since knowledge and understanding is acquired context-specific (Brown, 1989). Accordingly, a transfer of the mathematical knowledge into physics domain can not be expected automatically. On the contrary, there are even special difficulties due to large differences in the use of and approach to mathematics by physicists. The use of

mathematical language in physics differs in many ways from its use in mathematics (Redish, 2005).

On the other hand, the problems and difficulties arising with the use of mathematics within physics education must not be ignored. The objection that the application of formulas and calculations would hinder an understanding of physical concepts, lead to routine and “senseless” computing activities and brings additional mathematical difficulties with it, has to be taken seriously. However, one can assume that these problems stem in large part on the way in which mathematics is involved in physics teaching. Already Richard Skemp, a pioneer in mathematics education research, pointed out the difference between instrumental and relational understanding (Skemp, 1976). By focusing on instrumental skills like rote manipulations and learning rules, it is not possible to achieve a deep (relational) understanding of mathematical concepts. But especially for knowledge transfer a relational understanding is indispensable. Therefore, it is particularly important in physics classes to stress this kind of understanding of the relationship between physical behavior and mathematics. Using the common physical text book problems this is probably not achievable, as the findings of problem-solving research suggest (Maloney, 1994).

An attempt to improve these shortcomings of traditional teaching on problem solving is made by Bagno et al. (Bagno et al., 2008). They developed a learning tool focused on the interpretation of formulas, based on findings that demonstrate a lack of understanding of physical formulas. They report on mainly three different aspects of the problem: Students have difficulties in specifying the conditions under which a formula can be applied, they can only give vague descriptions of the components of a formula and they have difficulties in manipulating the units. After having used the learning tool improvements could be identified. This involved the students’ abilities to specify the conditions under which a formula can be applied, and to recognize special cases of the formula.

In line with these findings and with the aim to deepen the knowledge about students’ understanding of the relation between mathematics and physics, it is important to deeper explore the interplay of the difficulties students’ experience with mathematical physics tasks. This provides a basis for the main goal of developing teaching and learning strategies that help students build a relational understanding of the interdependency of physical and mathematical concepts.

## **Theoretical Framework**

A widely used framework in mathematics education research to describe the stages and activities that occur during mathematical modeling or problem solving, is the modeling cycle (Blum & Leiß, 2006). Within this framework the world is separated into the mathematical model and the “rest of the world”. The former field contains the pure mathematical activities like calculations et cetera, whereas the latter includes the stages of building the qualitative model and its evaluation. The connection between the rest of the world and the mathematics is provided by the translation processes, i.e. mathematizing (“into the mathematics”) and interpreting (“out of mathematics”). These processes are crucial for knowledge transfer, are highly context specific and demand high cognitive abilities. Whereas the pure mathematical work – on which many of the ordinary physical text book problems put much emphasis – can be learned within mathematics classes, the translation processes establish the link between physics and mathematics education.

With the translation to and from mathematics the so called “Grundvorstellungen” (vom Hofe, 1992) – a theoretical concept used in mathematics education research to describe the translation between ideas or meaning and mathematical operations – emerge as they mediate between the mathematical and physical world. The term “Grundvorstellungen” might be best translated as “basic ideas” or “fundamental conceptions”. It refers to mathematical objects



(i.e. mathematical operations, symbols etc.) and the ideas and conceptions connected to them. For example, a basic idea of “addition” can be the operation of adding two amounts to get the whole amount as a result. On the other hand, one can think of “addition” as changing an initial state to a final state – as in the case of temperature changes. Obviously there is not only one correct basic idea of a mathematical operation. Rather it is important to activate the basic idea corresponding to the specific problem one deals with. Therefore one needs to have more than one fundamental conception available for activation. Enabling a flexible use requires experience and knowledge based on comprehension or, in other words, a relational understanding.

In the physical context these “Grundvorstellungen” have to be connected to an understanding of the physical concepts and be activated in accordance to the physical situation. Sherin (Sherin, 2001) investigated the meanings college students assign to formulas and classified them as so called “symbolic forms”. A symbolic form is an entity in a formula which is associated with a corresponding physical behavior, e.g. a fraction stroke with a variable in the denominator means that the resulting behavior is inversely proportional to this variable. But as it is the case with the “Grundvorstellungen”, there also exist more symbolic forms for one formal structure. Sherin claims for ongoing research in the same direction with students at a younger age (i.e. high school and secondary school) and for teaching strategies which strengthen the use of symbolic forms. Also an in-depth analysis of its interplay with students' strategies and difficulties is still owing.

## **Research design**

For investigating the process of translation and the resulting difficulties students experience thereby, we developed special mathematical physics tasks in order to address different aspects of translating between physics and mathematics. By working with these tasks the students are challenged to actively carry out the translation and to establish the connection between mathematics and physics not on a calculational but on a meaningful basis. More specifically the tasks contain amongst other aspects

- the creation of a formula on the basis of physical reasoning
- the interpretation of the special cases of a formula
- to draw conclusions based on a formula for physical behavior
- explaining the meaning of a formula

The theoretical assumptions about the nature of the connection between physics and mathematics guided the construction of the tasks which can be regarded as a didactical reconstruction of facets of theoretical physicists' work. The degree of difficulty was validated by the observations made in the pilot study which also gave hints for improvements and additional ideas. The physical topic is mechanics due to the fact that this is the topic with the highest degree of mathematics involved in secondary school.

Invited students worked in pairs on these tasks at an interactive whiteboard. This method of data acquisition allowed us to conduct the observation without a video camera because the whiteboard provides the possibility to record the speech and writings simultaneously. The students were requested to discuss the problems with each other and get a joint solution in order to animate them to speak aloud and express their ideas and thoughts. This makes it possible to follow their lines of reasoning and thought processes to some degree.

In total we observed 30 students from grades 9 to 10 – i.e. 15 to 16-years old – from different schools of higher education. Parameters like school grades in physics, mathematics and german classes, as well as a short questionnaire on content-related self-efficacy were controlled to describe the sample. The grades indicate a selection of mainly good students, but with more satisfactory grades than very good ones.

The recorded speech will be transcribed and placed in relation to the writings. The transcripts will be categorized and evaluated according to a framework of qualitative data analysis like the Grounded Theory (Glaser & Strauss, 2005). The main goal of the classification is focused on students' difficulties, their mutual interplay and their effect on students' understanding of the role of mathematics for physics.

### **Preliminary findings**

On the basis of the observation of all students and the evaluation of transcripts of the pilot study it is possible to express some preliminary insights. An evident impression is that the students often revealed a basically instrumental understanding when using mathematics in physics. This is demonstrated by their technical approach to conceptual problems. For example, a proportional relation in a formula was identified with physical behavior only after calculating with some numbers. Also the translation was orientated towards superficial aspects as the connection between a formula and the physical world was established by symbols and units. On this pathway formulas were chosen, interpreted and validated. Even more some students created a formula on the basis of suitable units in contradiction to the already uttered physical behavior. Strikingly the association of formulas with physical models or behavior was absent in most cases.

Furthermore, students' physical and mathematical reasoning do not seem to be well balanced. Many students concentrated either mainly on the mathematical or on the physical aspects. Thus they miss out on important and possibly helpful links. Also the coherence of both kinds of reasoning is often not kept in mind which leads to an overlooking of mistakes. Moreover, it eliminates the possibility to use physical and mathematical considerations in a supporting manner.

As a special issue demonstrates the strategy to check formulas with the help of units. Many aspects were revealed which could lead to difficulties so that the effect of the whole strategy seemed to be more confusing than helpful in many cases. Particularly striking were difficulties while dealing with fractions, the confounding of symbols of physical magnitudes with unit symbols (e.g. canceling down mass and meter in a fraction), the concretization of units (e.g. 'm' or 'cm'), as well as remembering the right units in general. For the last point it is noticeable that units seem to only be remembered instead of being linked with physical meaning (e.g. m/s as displacement per time). This is also indicating a more instrumental than relational understanding of physical units that leads to difficulties in selecting the right units.

### **Acknowledgement**

Thanks to the European Social Fund (ESF) and to the Free State of Saxony for the financial funding of this PhD-project.

### **References**

- Bagno, E., Berger, H., & Eylon, B.S. (2008). Meeting the challenge of students' understanding of formulae in high-school physics: a learning tool. *Physics Education* 43(1), 75-82
- Blum, W., & Leiß, D. (2006). How do students and teachers deal with modelling problems? In C. Haines, P. Galbraith, W. Blum & S. Kahn (Eds.), *Mathematical Modelling (ICTMA12): Education, Engineering and Economics*. Chichester: Horwood Publishing, 222-231
- Brown, J. S., Collins, A., & Duguid, P. (1989). Situated Cognition and the Culture of Learning. *Education Researcher*, 18(1), 32 – 42
- Einstein, A. (1956). *Mein Weltbild*. West-Berlin: Ullstein
- Feynman, R. (1992). *The character of physical law*. London: Penguin Press Science
- Glaser, B. G., & Strauss, A. L. (2005). *Grounded Theory: Strategien qualitativer Forschung*. Bern: Huber
- Hofe, R. vom (1992). Grundvorstellungen mathematischer Inhalte als didaktisches Modell. *Journal für Mathematikdidaktik*, 13 (4), 345-364

- Lederman, N.G. (1992). Student's and teacher's conceptions of the nature of science: A review of the research. *Journal of Research in Science Teaching*, 29(4), 331-359
- Maloney, D. P. (1994). Research on problem solving: Physics. In D. L. Gabel (Ed), *Handbook of Research on Science Teaching and Learning*. New York: Macmillan, 327-354
- Redish, E. F. (2005). Problem solving and the use of math in physics courses. *Proceedings of the Conference, World View on Physics Education in 2005: Focusing on Change, Delhi, India, August 21–26*.
- Sherin, B. (2001). How students understand physics equations. *Cognition and Instruction*, 19 (4), 479-541
- Skemp, R. R. (1976). Relational understanding and instrumental understanding. *Mathematics Teacher*, 77, 20-26

# Utilising technology to develop a collaborative approach to the teaching and learning of physics and mathematics in second level education in Ireland

Dr. Máire Ní Ríordáin, Dr. Jennifer Johnston

Dr. George McClelland and Prof. John O'Donoghue

National Centre for Excellence in Mathematics and Science Teaching and Learning

(NCE-MSTL), University of Limerick  
maire.niriordain@ul.ie & jennifer.johnston@ul.ie

*The aim of this research project is to design, implement and evaluate a collaborative teaching approach in physics and mathematics education in second level schools in Ireland. This is undertaken through the integration of a handheld graphic calculator into the teaching and learning of physics and mathematics in first year classes at second level education. Action research was the central methodology of this project. A key outcome of this project was the development of specific lesson plans to help facilitate the integration of both subjects. The study was evaluated through a teachers reflective log book and teacher interviews. The qualitative data reports the teachers' experience of the project. The integrated science and mathematics lessons were observed by an independent observer. The observer recorded how the lesson plans were implemented and assessed if the learning outcomes were achieved. The key findings emerging from this research project will be presented.*

## 1 Introduction

The aim of the research project was to design, implement and evaluate a collaborative teaching approach to develop students' conceptual understanding in physics and mathematics at post-primary education. This was assisted by the development and implementation of specific lesson plans (3 double science lessons and 4 single mathematics lessons) that integrated the teaching and learning of both subjects utilising technology. The implementation of the collaboration between the science and mathematics teachers was facilitated by the use of technology – the TI-Nspire (graphical calculator and data logger) that allowed real-life data to be collected, analysed and explored both in the mathematics and science lessons. The mathematics and science teachers involved in this project were supported in designing, implementing and evaluating innovative lesson plans which integrated Junior Cycle (lower second level education) science and mathematics topics which promote conceptual understanding. By improving the students' level of conceptual understanding of science it is envisaged that this will improve their mathematics ability; by improving students' mathematical skills it will facilitate the development of their conceptual understanding in science.

## 2 Methodology

The research focus of this project is on inquiry based learning and pedagogical enhancement, utilising technology, and with the aim of improving students' conceptual

understanding of motion. The overarching methodology employed in this study was action research. It was chosen as the methodology because it is useful when investigating how to improve learning and taking social action (McNiff and Whitehead 2006). Within this, case studies and several mixed research methods were employed. This innovative project was piloted in three second level schools in the Limerick/Tipperary region, in Ireland. One mathematics teacher and one science teacher worked in collaboration, with each other and with the NCE-MSTL team, in each of the participating schools. Teacher training in the use and integration of the technology into the teaching and learning of science and mathematics took place from September '09 to December '09. The active research of the integrated science and mathematics lesson plans took place from January '10 to March '10. First year post-primary education students of mathematics and sciences (approx. age 13-14 years old) defined the context of the study.

## **2.1 Instruments for data collection**

Qualitative data on the teachers' experience of the project was collected through a teachers reflective log book and teacher interviews. Data was collected by an independent observer on how the lesson plans were implemented. All mathematics and science lessons were observed, however due to time constraints a different individual observed each lesson. The observers also assessed whether or not the learning outcomes for each lesson were achieved.

## **3 Science Approach**

Research has highlighted the importance of building the development of scientific concepts and skills on concrete experience (Rosenquist and McDermott 1987). The science lesson plans were designed to promote the constructivist approach through the use of inquiry based learning (Piaget 1928; 1952). Brooks and Brooks (1993) stated that meaningful learning occurs when new knowledge and skills are embedded in context, and students make connections among idea. The lessons were designed to engage the students in the active use of concepts in concrete situations. Everyday objects and experiences from their everyday lives were used in the science lessons. The inquiry based approach helps the students close the gaps in their knowledge through repeated exercises that are spread out over time and are integrated with the subject matter of both the science and mathematics courses. To help the learner assimilate abstract concepts, it is essential to engage the learner's mind in the active use of the concepts in concrete situations (Arons, 1990). The concepts must be explicitly connected with immediate, visible, or kinaesthetic experience. Furthermore, the learner should be led to confront and resolve the contradictions that result from his or her own misconceptions (Arons, 1990). There are several learning difficulties that are involved in the development of the concepts of distance, speed and time. 'A powerful way of helping students master a mode of reasoning is to allow them to view the same reasoning from more than one perspective' (Arons, 1990). An effective way of reaching many students who have difficulty in relating position on a graph to motion is to lead them through direct kinaesthetic experience. Giving them problems in which they must translate from the graph to an actual motion and from an actual motion to its representation on a graph.

## 4 Mathematics Approach

The mathematics lesson plans were designed to promote a teaching for understanding approach through the use of rich mathematical tasks which provide students with the opportunity of specializing and generalizing in the mathematics class (Mason, 1999). A new mathematics curriculum, *Project Maths*, is being introduced in all post-primary schools in Ireland. Emphasis is being placed on student understanding of mathematical concepts, with increased use of contexts and applications that will enable students to relate mathematics to everyday experiences (Project Maths, 2008). Thus the mathematical approach adopted in this research project is consistent with the new mathematics curriculum being introduced.

### 4.1 Rich Mathematical Tasks

Mathematical tasks that are referred to as ‘rich’ are those that are most likely to engage students positively and effectively with their mathematical learning. Rich mathematical tasks were a critical component underpinning the mathematics pedagogy of this research project. The importance of incorporating ‘rich mathematical tasks’ into the teaching and learning of mathematics has been highlighted by many researchers (Boaler & Staples, 2008). They can be described as incorporating some of the following characteristics (Ahmed, 1987):

- Are accessible and extendable.
- Allow individuals to make decisions.
- Involve students in testing, proving, explaining, reflecting and interpreting.
- Promote discussion and communication.
- Encourage originality and invention.
- Encourage “what if?” and “what if not?” questions.
- Are enjoyable and contain opportunity to surprise.

By employing rich mathematical tasks it allows students to find something challenging and at an appropriate level to work on (Swan, 2005).

### 4.2 Specializing and Generalizing

Within the mathematics element of this project we were also concerned with how students approach problem solving. Mason (1999) emphasises the central core of mathematics as *Specializing* (constructing particular examples to see what happens), and *Generalizing* (detect a form; express it as a conjecture; then justify it through reasoned argument). Specializing involves trying specific examples in order to develop an understanding in relation to what a mathematical concept is proposing. Therefore, the purpose of specializing is to gain clarity as to the meaning of a question or statement, and then to provide examples which have some general properties in common – the process of generalizing (Mason, 1999). Generalizing has to do with noticing and describing properties common to several mathematics questions/problems. The mathematics teacher should employ questions which encourage students to think deeply about the problem/examples presented. By looking at the examples that the students have

completed, they should try to see what is common among them, guided by what the problem or text asks for or states (Mason, 1999).

## **5 The Interdependent Lesson Plans**

The active research of the integrated science and mathematics lesson plans took place during March and April, 2010, over the course of three weeks. What follows is a description of each of the lesson plans and they are presented in the order that facilitated the integration.

### **5.1 Science Lesson 1**

The first double lesson attempted to engage the students in the ideas and concept of motion. The teacher facilitated a discussion on speed drawing on their experiences from everyday life. With the teachers as the facilitator, the students would generate ideas on how to measure speed and how it can be represented. With household material the students built their own balloon rocket cars. The purpose of the balloon rocket car was to help the students take ownership in the design of their cars and it was used to aid the development of the concepts of distance, speed and time over the 3 weeks. At the end of the first lesson the student would have built and tested their balloon rocket cars and would have also generated ideas of how to measure speed using their cars, the TI-Nspire and the motion probe.

### **5.2 Mathematics Lesson Plan 1**

It was anticipated that students may have some experience of drawing and interpreting graphs from previous science lessons. However, the teachers involved in this research project felt that it was essential that students' basic graphical skills were well developed to ensure that the implementation of the other mathematics and science lesson plans were successful. Therefore, the purpose of the first mathematics lesson plan was to provide students with key skills (drawing and labeling axes; plotting coordinates; interpreting graphs) required for drawing graphs.

### **5.3 Science Lesson 2**

The second science lesson began with a recap of how speed could be measured leading to a discussion on how speed could be represented. Using their hand made cars they were asked to predict, analyse and test their ideas about motion. Through the aid of the motion probe and the TI-Nspire they tested their predictions and collected data on the handheld. Using the data generated the students drew a distance-time graph in their lab copies. With the aid of several other distances versus time graphs the students were challenged to apply their experience with the balloon rocket cars to interrupt the new graphs. Thus, to generate the relationship between distance, speed and time from their experience.

#### **5.4 Mathematics Lesson Plan 2**

The purpose of the second mathematics lesson plan was to develop further students' understanding of graphical concepts in relation to travel graphs (scale, units, speed, slopes, direction of lines). Mathematics Lesson Plan 2 also incorporated the use of data generated from the previous science lesson to draw distance-time graphs, while also encouraging discussion and explanation of variations in their findings in relation to the key concepts developed.

#### **5.5 Science Lesson 3**

The final double science lesson involved the students actively acting out their motion using the TI-Nspire and the motion probe. In the previous mathematics lesson students examined questions in relation to the direction of the motion and the slope. The active experience of acting out this motion helped the student connect the graph on paper to actual motion. For example, being able to distinguish between positive slopes, negative slopes, no motion etc., all concrete experiences. Thus they developed further the relationship between distance, speed and time by predicting and acting out the motion of the graphs.

#### **5.6 Mathematics Lesson Plan 3**

The overall aim of the lesson was that students themselves would generate the average speed formula through completion of mathematical rich tasks concerned with speed, distance and time. These tasks incorporated real-life applications, thus making the material relevant for student learning.

#### **5.7 Mathematics Lesson Plan 4**

The last mathematics lesson plan was concerned with furthering students' understanding of the concept of average speed through engagement in the different sets of distance and time data they had collected in the science lesson. Students were required to demonstrate key learning outcomes acquired from the previous science and mathematics lessons, while appreciating the application of mathematics in science and real life applications.

### **6 Results**

The following section will summarise some of the key findings emerging from the teacher's reflective journals and from the lesson observations. These are presented from the perspective of the subject area teachers i.e. science and mathematics, the students and technology concerns.

#### **6.1 Teacher Reflective Journal**

From the mathematics teachers' reflective journals it is evident that the teachers thought the tasks incorporated into the mathematics lesson plans were appropriate and consistent



with the learning outcomes stated. However, they strongly felt that there were too many tasks per lesson which had repercussions for time management and facilitating the integrated teaching approach. Similarly, the teachers felt that there was too much time between the specific mathematics lesson plans (a week on average) and they felt that it would be better if they were closer so as to facilitate reinforcement of previous learning. Although the teachers concerned liked the tasks presented in the lesson plans they found it difficult adapt to the new style of teaching. On a positive note, the teachers could see the benefits of this style of teaching for student learning and understanding, but it came at cost of lack of syllabus coverage and justifying spending such an amount of time on ‘just one topic’.

In general, the inquiry based approach of the science lessons was not adopted as expected by the authors. Teachers failed to give the students enough time to respond and come up with their own ideas and like the mathematics lesson they tended to be teacher dominant rather than student centred.

Both the science and mathematics teachers involved in this research project found positive outcomes for student learning and understanding. The teachers’ reflections portray students as engaged, interested, responding well and enjoying the mathematical and science activities. In particular, engagement was highly correlated with building, designing and personalising the balloon rocket car, while working collaboratively with peers. Similarly, the students responded well to the introduction of technology into the teaching and learning of the subject areas, ensuring relevance to their elevated use of technology in their personal lives. Moreover, the teachers felt that the integrated approach helped to develop students’ understanding of the relevance of mathematics *for* science and science *for* mathematics.

In terms of the teachers’ capability to integrate technology into the teaching and learning of science and mathematics, they depict in their reflections a lack of confidence in their competence and accordingly this impacted on the successful integration of the TI-Nspire into their lessons. For example, some of teachers would first do some of the tasks by hand on the whiteboard, copybook, etc. and then *repeat* the same activity using the TI-Nspire. Unsurprisingly, difficulties arose with the technology such as batteries running out, motion sensors, etc. All expressed an interest in further training to become more competent in the use of the technology in the classroom.

## **6.2 Observers’ Reflections**

The observers’ reflections on the mathematics/science lessons undertaken by the teachers reinforce the didactical style taking place in the classrooms. The lessons were dominated by teacher talk as opposed to the student-centred approach promoted by the lesson plans. Little discussion took place. There appears to be a difficulty in moving away from the ‘norm’ and ‘comfortable/safe’ approach utilised prior to the development of these lesson plans. The observations also expose that the mathematics teachers missed out on some key concepts within the lessons. Similarly, there was poor use of ‘mathematics language’ by the teachers and there appears to be a lack of confidence in their students’ ability to cope mathematical terminology and concepts. Naturally this has repercussions for

students' learning and understanding for both mathematics and science. On an encouraging note, some tasks within the lesson plans were done very well by individual teachers and this is a positive aspect to take forward. The observations also noted that the students responded positively to these tasks when done well. Conclusions emerging from the observations portray a lack of confidence by the teachers in adopting the new teaching approach but when done well, student learning and understanding was enhanced. Moreover, some of the teachers did struggle with the technology aspects of the lessons but the students were competent and confident in utilising the technology, while engaging them in learning and applying knowledge.

## **7 Conclusion**

All teachers involved in this pilot are interested in taking part in the second phase of the project. Preliminary findings have shown that the integration of science and mathematics teaching and learning at post-primary education facilitated authentic learning experiences for the students and teachers involved in this pilot study.

## **8 Acknowledgements**

The authors thank the local schools, teachers and students who took part in this study. We also acknowledge Texas Instruments for providing resources and assistance, which were an integral part of this project.

## **9 References**

- Ahmed, A. (1987). *Better Mathematics: A Curriculum Development Study*. London: HMSO.
- Arons, A. B. (1990). *Teaching Introductory Physics*. New York: Wiley.
- Boaler, J. & Staples, M. (2008). Creating mathematical futures through an equitable teaching approach: the case of Railside school. *Teachers College Record*, 110(3), 608-645.
- Brooks, J. G., & Brooks, M. G. (1993). *In search of understanding: The case for constructivist classrooms*. Alexandria, VA : Association for Supervision and Curriculum Development.
- Brooks, J. G. & Brooks, M. G. (1999). The constructivist classroom: the courage to be constructivist. *Educational Leadership*, 57 (3), 18-25.
- Mason, J. (1999). *Learning and Doing Mathematics (2<sup>nd</sup> Ed.)*. York: QED.
- McNiff, J. and Whitehead, J. (2006) *All You Need to Know About Action Research*, London: Sage
- Piaget, J. (1928). *The Child's Conception of the World*. London: Routledge and Kegan Paul.
- Piaget, J. (1952). *The Origins of Intelligence in Children*. New York: International University Press.

Project Maths (2008). Information available at [www.projectmaths.ie](http://www.projectmaths.ie).

Rosenquist, M. L. and McDermott, L. C. (1987). A conceptual approach to teaching kinematics. *Am. J Phys.*, 55 (5), 407-415.

Swan, M. (2005). *Improving Learning in Mathematics: Challenges and Strategies*. UK: DfES Standards Unit Publication.

# STUDENTS' USE OF MATHEMATICAL REPRESENTATIONS: SOLVING PROBLEMS IN KINEMATICS

Silvia M. Pérez

IDH, Universidad Nacional de General Sarmiento. Argentina  
sperez@ungs.edu.ar

M. Celia Dibar Ure

ICI, Universidad Nacional de General Sarmiento. Argentina  
celiadibar@yahoo.com

## ABSTRACT

We present a preliminary discussion of the strategies and mathematical representations (graphical, algebraic, numerical or linguistic) used by university students to solve a paper and pencil problem in kinematics: a car moving down a slope. Twenty one students, who were taking their first Physics course, were asked about velocities and times in different parts of the slope. Using a qualitative and exploratory methodology, we constructed categories starting from the actual data.

We find that all students quickly substitute numerical data, even if they have already written the equations in an algebraic form. This substitution seems to help recognize which are the unknown data and which data they need in order to solve the problem. Almost half of the students assume that the car's acceleration is  $g$ . This assumption transforms the problem so that it has one extra given data which leads these students to unexpected ways of going wrong. Some students can perceive their own errors. It is important to stress the metacognitive task that students are performing in registering that a solution is wrong.

We could reconstruct a "path" that most students seem to follow to solve the problem and we could also find some clues as to what elements the students use to solve a given problem.

## INTRODUCTION

Teaching, learning, communicating or doing research in physics implies using mathematical language. Teachers often express their doubts as to whether students know enough mathematics to learn Physics. But when they do know mathematics, can they use what they already know to solve problems? Students have difficulties in the use of mathematical language and these become evident when they solve problems. To do so, students must choose the right model, apply the equations, solve them and then interpret the results. This involves using the mathematical tools they have but adapting their use to Physics.

## APPROACH AND PERSPECTIVES

Our main research question is: how do students use mathematical tools when they first approach problems in physics? Other questions follow: what clues do they use to go about it? How do they check that they are on the right track? How do they use linguistic, graphical, algebraic and numerical representations?

We pretend to build a grounded theory (Glaser y Strauss, 1968; Turner, 1981) based on the analysis of the data provided by the students' answers rather than start from a given theory. We know that it is impossible to believe that our approach is not theory laden but we try to be as objective as possible when analysing the data. To do this we first discuss our expectations and

theories that may be related openly. At a later time, when the analysis of the data has been done, the results can be discussed with respect to related theories (Turner, 1981).

We present the first results obtained from analyzing the answers of university students to a problem in kinematics. This analysis is centred in the description of their use of mathematical language. We have chosen to study the answers to a typical problem of elementary physics as we are interested in knowing more about the process of mastering the use of the given equations (in this case  $x(t)$  and  $v(t)$  for constant acceleration) to solve a particular problem.

## **THE PROBLEM AND OUR STUDENTS**

The problem studied was designed after discussing previous results (Pérez & Dibar, 2009). It was solved by 21 students enrolled in the first physics course at Universidad Nacional de General Sarmiento. They had completed an introductory course in Mathematics and had finished the equivalent of an Introductory Calculus Course. Their knowledge of Physics from secondary school is usually very poor. Half of the students were enrolled in the General Physics course for the second time. Their mean age was 23.3 years. Only half of these students had enrolled at the university directly after secondary school. They were evenly distributed between men and women.

The problem was passed during a class. The students had previously studied kinematics and had solved some of the usual problems.

### **Problem**

*A group of friends is going downhill in a car when suddenly the motor stops. The driver puts on the break until the car finally stops still. They all decide that the best solution is to take off the break and let the car roll down the slope until the car acquires enough velocity for the motor to start on its own. They take the break off and after 6 minutes, when the car has rolled 54 m, the motor starts.*

- a) *What type of movement does the car have?*
- b) *What was the car's velocity when the motor got started?*
- c) *How long did it take to cover half of this distance?*
- d) *What was the velocity of the car at that moment?*
- e) *What was the mean velocity from the moment the break was taken off to the moment the motor started?*

*It is important that you hand in all that you write while you are trying to solve the problem, for example the rough copies.*

## **HOW WE STUDY THE DATA**

Using a qualitative and exploratory methodology, we constructed categories starting from the actual data (Glaser and Strauss, 1967, Turner). We carried out the analysis in three steps. The first step follows naturally from immersing into the data to let the most salient characteristics emerge. An exhaustive categorization followed. As the third step, instead of re categorizing, we looked for different “dimensions” to describe the answers in more depth.

### **First step**

The most salient characteristics after the first look at the data are:

- All students write algebraic equations but quickly substitute the given data. Their treatment of algebraic equations is usually adequate. With this substitution they can recognize (correctly or

not) which are the unknowns in order to solve the problem. They proceed thus until they have only one unknown data and they solve it. We had found this same procedure in a previous work (Pérez & Dibar, 2009)

- Ten of the 21 students assume the car's acceleration to be  $g$ . The problem now has one extra data, but none of these students realize this.
- Only two of the students make a mathematical error in the treatment of the algebraic representation.
- None of the students are lead astray due to the relatively elaborate way in which the problem was written, in an attempt to describe a real life situation.
- Thirteen students make schemes (graphic simplifications of the situation) similar to those that have been taught. The passage from the linguistic representation to the "scheme" enables them to start to elaborate a factic model (Lombardi, 1998) of the situation, to identify the given and the unknown data quite well.

### **Second step**

After the first look we carried out a classification by grouping the answers to describe how students tried to solve the problem and what tools they used, but always staying very close to their answers.

- *Completely correct answers*  
Six students solve the problems correctly.
- *"Correct" but using the acceleration of gravity,  $g$*   
Two of the students, although incorrectly assuming that the acceleration is  $g$ , solve the problem using the position and velocity equations for constant acceleration correctly. They proceed to answer the questions posed by the problem in a way by which they do not register their initial error and they do not arrive at contradictions.
- *Answers using  $g$  that show disorientation*  
Seven students assume that the acceleration is  $g$  and then seem to get lost while trying to solve the problem. Three of them work with the functions for  $x(t)$  y  $v(t)$  whilst four of them only use the equation for position. They treat the initial velocity as if it were a variable.
- *"Naive" answers*  
Six of the students seem to have a more naive vision about how to solve it. They use formulas like " $v = x/t$ ". They don't seem to know about time dependent magnitudes, but identify "the" velocity or "the" position with one of the problem's data.

### **Third step**

We found some aspects in the students' answers, that give light to the problem of using mathematics in physics:

- *Recognition of errors*  
While working within an algebraic representation or when interpreting some of the results obtained, 8 of the students show that they have detected that something is wrong and they correct it or abandon the problem altogether. They cross out what they have written or they make this awareness explicit by using words.  
Four of these errors refer to the signs of variables. For example a student obtains two different positive values of the time the car takes to descend, he then crosses out this result

and starts a new way to solve the problem. Another student obtains a negative value for the initial velocity and gives up.

Another student gets a negative value for time and corrects the equation. However, he later accepts a negative value for a velocity.

A student realizes that he obtains the same value for all velocities. He abandons what he is doing and tries to solve it by using dynamics and succeeds.

A student detects that something is going wrong with his algebraic expressions for calculating the velocity when he gets the same numerical value as when he calculated the position. He corrects this expression and solves the problem correctly.

Finally, 2 students have doubts because the units of the result turn out wrongly. One of them corrects the error and the other one just writes down that he thinks it should not be so.

- *Answers when one unknown is left out*

In the first classification of the answers we saw that 10 of the 21 students use  $g$  without questioning this choice. From their earliest experiences they have seen objects falling when nothing supports them or when placed in any kind of inclined plane. They have later learnt that in free fall the object accelerates with  $g$ . They don't seem to question that this may not be so in the case of an inclined plane.

This assumption leads them to ways of solving the problem which we have described earlier.

The main change introduced in this case is that one unknown disappears. The position equation has only one unknown (time) in a quadratic equation which the students solve easily and willingly. Curiously enough, no student arrives to the contradiction that would become apparent if they substituted all the data into the equation for the position of the car.

Four of the students do write the equation for position, but do not use the equation for velocities. Instead they treat the initial velocity as a variable, probably because the problem asks for a velocity. For them the velocity could then be a constant throughout the movement, an initial condition or a function of time.

## FIRST RESULTS

Through the three steps of analysis of the data we have been able to see their salient characteristics, the different ways of solving and the metacognitive activity involved in the recognition of errors and decision making about the value of a variable.

We can reconstruct a "path" that most students seem to follow to solve the problem.

The students generally

1. They read the problem, interpreting the linguistic representation.
2. They do a simplified scheme (graphic representation). They extract the essential data and unknowns.
3. They choose a type of movement and write the corresponding equations. Some write only one equation for the constant acceleration case.
4. They substitute numerical data. They make choices based on interpretations (i.e.  $v_0=0$ ). Almost half of them choose  $a=g$ . They solve the equations by a correct treatment of algebraic representations.
5. They interpret the results, taking into account possible errors. If there are none or if they don't detect them, they write briefly about the results of the problem using a linguistic representation.

This path that they follow, while respecting the particular differences, may suggest a model of what our students are doing to solve problems.

During the analysis of the data we also found some clues as to what elements the students lean on to solve the given problem. In order to advance, these clues or not completely defined rules provide the students intermediate “certainties” which help them arrive to the resolution. Some of them are usually taught explicitly during the physics courses. Others are adopted by the students (like strategies that were successful in solving previous problems).

Among the ones that are taught, we may point out:

- To make a scheme that represent the problem’s important data
- To write the dependence of functions explicitly (i.e.  $x(t=6 \text{ s})$ .)
- To discard the negative times obtained as solutions (in general)
- To check the units of magnitudes obtained through calculation.

Among those of the second type (found by the students):

- If the moving body falls “on its own”, the acceleration is  $g$ . This may be reinforced in problems where the acceleration is not asked for explicitly.
- If they are asked for a velocity at a given point, they tend to use it as the initial velocity,  $v_0$ .
- If the sign of the calculated velocity is negative, it may indicate that something is wrong.

The study of strategies that students use helps us understand what is useful and what is not on the way to solving a problem. It is here that we may see the mathematical tools interpreted in the light of physical concepts.

## DISCUSSION

We have seen that some of our students show confusion in the use of variables, constants and initial conditions as Redish (2005) alerts. In some cases it becomes evident when they detect their own errors, in others when the incorrect choice of  $g$  as the acceleration triggers multiple erroneous solutions.

The problem chosen forces the students to work with linguistic, graphical, algebraic and numerical representations (Duval, 1993). No difficulties appear with the treatment of algebraic representations or when the linguistic representation is converted into a scheme. However, students we classified as giving naive answers and those that use  $g$  as the acceleration have problems with the conversion to algebraic representations. In the first case because the algebraic model is wrong, in the second one because they work with only one of the equations.

If we start from what students actually do in order to solve a problem, their paths and strategies may allow us to understand how they are dealing with the problem and as well as to make some teaching suggestions.

We plan to go deeper into how the students deal with variables, constants and initial conditions. Although we have briefly described some of the difficulties they find with these, we need more information to interpret them fully.

## REFERENCES

- Duval, R. (1993) Registres de representation semiotique et fonctionnement cognitive de la pensée. *Annales de Didactique et de Sciences Cognitives*. 5. 37 – 65. IREM. Strasbourg. France
- Glaser, B. y Strauss, A. L. (1967) *The discovery of grounded theory: strategies for qualitative research*. Chicago, Aldine



Lombardi, O. (1998). La noción de modelo en ciencias. *Educación en Ciencias*, 2(4), 5-13.

Pérez, S.M. y Dibar, M.C. (2009). Cinemática: de los números a las representaciones algebraicas. *Enseñanza de las Ciencias*, Número Extra VIII Congreso Internacional sobre Investigación en Didáctica de las Ciencias, Barcelona. 145-148. <http://ensciencias.uab.es/congreso09/numeroextra/art-145-148.pdf>

Redish, E. F. (2005) [Problem Solving and the Use of Math in Physics Courses](#), *Proceedings of the Conference, World View on Physics Education in 2005: Focusing on Change*. Delhi. <http://umdperg.pbworks.com/Joe-Redish%253A-Selected-Publications>

Turner, B. A. (1981) Some practical aspects of qualitative data analysis: one way of organizing the cognitive processes associated with the generation of grounded theory. *Quality and Quantity*. 15, 225-247

## Mathematics in physics lessons: developing structural skills

Ricardo Karam<sup>1,2</sup>

karam@usp.br

Gesche Pospiech<sup>1</sup>

gesche.pospiech@tu-dresden.de

Maurício Pietrocola<sup>2</sup>

mpietro@usp.br

<sup>1</sup>Department of Physics, Technische Universität Dresden, Germany

<sup>2</sup>School of Education, University of São Paulo, Brazil

### Abstract

Many physics teachers complain that their students do not know enough mathematics. However, it seems that the domain of basic mathematics skills does not guarantee success in physics, once using mathematics in physics is much more complex than the straightforward application of rules and calculation. In fact, in spite of the deep interrelations between physics and mathematics, confirmed both by historical and epistemological studies, in the context of physics education, mathematics tend to be seen as a mere tool to quantify physical entities and express the relations between them. In order to face up to this inconsistency, we consider a distinction between technical skills – the ones related to the domain of basic rules of mathematics and normally developed in math's classes – and structural skills – which are related to the capacity of recognizing the structural role of mathematics in physical thought. We believe that one of the most important abilities to deal with phenomena in physics domain is to be able to use mathematics as a reasoning instrument. For that reason, we try to understand the physicist's use of this structural approach in a didactic context. University physics lessons given by a distinguished professor on Electromagnetism and Special Relativity were videotaped in order to investigate the structural approach in real classroom situations. The analysis of these lessons allowed us to identify a set of four structural skills which are defined and exemplified.

### Introduction

The deep interdependency between mathematics and physics is well acknowledged by several exponents of both fields. Many physicists have stressed the indispensable role of mathematics in physics. Among them, Galilei (1854, pp. 60) wrote that “the universe is written in mathematical language” and Einstein (1934, pp. 117) believed that “the actual creative principle in physics lies in mathematics”.

But mathematics also benefits from physics and this is recognized by many mathematicians. Kline (1960, pp. vii) stated that “mathematics is primarily man's finest creation for the investigation of nature”, while Poincaré (1958, pp. 82) underlined “physics not only gives mathematicians the occasion to solve problems; it makes them foresee the solution; it suggests arguments to them”.

In spite of this briefly outlined mutual interplay between mathematics and physics, it is possible to say that in the context of education, these two disciplines tend to be treated separately and the students hardly become aware of this successful interrelation. In physics classes, it is not uncommon to find mathematics being treated as a mere tool to quantify empirical relations and to solve standard problems by finding formulas in a “mathematical

toolbox”. In maths classes, physics tends to be seen as an application of previously defined mathematical abstract concepts.

We believe that there is a strong inconsistency between the historical interdependency and the educational independent approach of mathematics and physics which claims for a systematic research effort. Likewise, Hestenes (2003, pp. 104) states that “the challenge is to seriously consider the design and use of mathematics as an important subject for Physics Education Research”.

Aiming at contributing to this challenge, we propose a distinction between *technical* and *structural skills* (Pietrocola 2008) to analyze students’ and teachers’ use of mathematics in physics and the comprehension of their interdependence. The *technical skills* are related to the instrumental ability to apply mathematical rules and algorithms in physics, whereas the *structural skills* are associated to the use of mathematics to structure physical thought and to the recognition of the deep connection between the physical content and the mathematical formulation of a particular concept.

Our main goal is to characterize the latter ones and investigate how they can be approached in physics lessons. From the analysis of university physics lessons, we derived a set of four structural skills which are defined and exemplified.

## Method

Concerning the methodological design of our research, we decided to conduct a case-study. Our data consist of the recordings from two university level physics courses performed by a particular professor at the University of São Paulo: 13 lessons on Special Relativity and 35 lessons on Electromagnetism, which makes a total of approximately 70 hours of video. We focused our attention on the moments where the professor used mathematical structures to explain basic concepts and to solve problems.

It is important to mention that the lessons from this professor were not chosen by chance. This particular professor was chosen due to the fact that he is widely admired and recognized, both by his students and colleagues, for having a “different approach”, since he normally encourages his students to reason about the physical interpretation of the mathematical formalism. The hypotheses we had was that his approach would focus on highlighting the structural role of mathematics, instead of its technical aspect.

The analysis of the data led us to identify a set of four structural skills. In the next section, we define each one of them and present examples of how they were approached during the lessons.

## Structural skills

### ➤ *Mathematizing (from physics to mathematics)*

The first identified structural skill is called *mathematizing* and is related to the process of translating from the physical world (conceptions about nature, phenomenological observations and experimental data) to mathematics (mathematical structures and formulas). Being successful in this transfer process depends on being able to think mathematically, which involves not only a significant understanding of mathematical concepts and theories, but also the ability of abstracting, idealizing and modelling physical phenomena.

In fact, this very complex process is quite often taken for granted in physics lessons. We observed that the professor gave a special attention and dedicated a considerable amount of time to *mathematizing*. This approach normally took place in the introduction of a new idea or concept. Some sentences were extracted from the recordings and are commented below.

<p>M1: <i>This frame of reference is a reasoning instrument; it is not in nature, but in your mind.</i></p> <p>M2: <i>You make a mathematical cut in the wire, with your mind.</i></p>
--

Here we realize that the professor is concerned on highlighting that mathematics is a human construct which is not found in nature. It is an abstraction created by the human *mind*. This can sound obvious at a first glance, but from the professor's intention to mention it explicitly, it seems as if he wanted to stress that it is not. The *mathematical cut* from the second sentence is an attempt to make clear the distinction between a real and a mental cut (with an infinitesimally small length  $dx$ ) of the wire.

*M3: In order to maintain the symmetries of space and time this rule has to be a linear transformation.*

This statement was extracted from the Special Relativity course during the derivation of the Lorentz transformations. It reflects the professor's intention of *justifying* the use of a particular mathematical structure (linear transformation) due to the physical desire of maintaining the symmetries of space and time. We believe that being able to identify the essential aspects that justify the use of mathematical structures in physical phenomena is a crucial ability for a meaningful mathematization. In trying to describe the process of translating from physics to mathematics, Redish (2005) states that:

We map our physical structures into mathematical ones – create a mathematical model. To do this, **we have to understand what mathematical structures are available and what aspects of them are relevant to the physical characteristics we are trying to model** (Redish, 2005, pp. 7, our emphasis).

In general, we found that the development of the mathematizing skill was a conscious goal of the lessons, due to both the great amount of time dedicated and to the constant concern of mentioning it explicitly. However, whenever one mathematical expression/formula was reached, the professor tried to give it a physical meaning. That leads us to the second structural skill.

➤ *Interpreting (from mathematics to physics)*

After presenting or deriving a mathematical expression, either when introducing a new concept or solving a problem, the professor's focus was immediately directed to the physical interpretation of its meaning. We identified this skill as *interpreting* and noticed that it also played a central role in his lessons. Not a single time a formula was presented without an explanation of its physical meaning. This was done with the aid of both powerful schemas and an intensive use of gestures. We exemplify this approach with the sentences below.

*I1: What does this expression mean? What does it say?*

*I2: It is important that you realize the power of this expression. It has the instruction for you to draw the arrow at any place in space.*

We realize that the professor is claiming for a deep understanding of mathematical expressions. In the first sentence he asks his students to say what a particular equation means, as if it were possible to “read” it out loud. In the second, the power and meaning of the electric field's equation is explained.

*I3: What do you physically expect from the result? Test/play with the result. What if  $x$ ,  $y$  or  $z = 0$ ? Is it reasonable? Does it make sense? If you don't expect anything from an equation your lost.*

*I4: If you go far away for the bar, shouldn't it be like a dot? Your result must be coherent.*

These sentences show that identification of special/limit cases is an important strategy used by the professor to develop the skill of *interpreting*. After reaching a particular expression, he

usually encouraged his students to verify its consistency by comparing some results given by the expression with their previous physical expectations. His explicit remark that one should always expect something from an equation is mostly interesting.

*15: How did the information of the problem got into the calculation? [...] The shape is given by the integration limits.*

*16: I'm not asking you how to solve a double integral; I want you to know what you are doing when you integrate.*

The meaningful understanding of the formalism is once again emphasized in these phrases. It becomes clear that the professor wants his students to make a conscious use of mathematics instead of applying it as a mere tool. When he says that he doesn't want them to solve, but to know what they are doing when solving a double integral, it is clear that he considers the structural role hierarchically superior to the technical.

The interplay between mathematizing and interpreting was a constant presence in his lessons. However, in some particular moments, a deeper discussion between the relation between mathematics and physics was conducted and some essential aspects of this interplay were explicitly mentioned. Therefore, we decided to classify these moments in two other categories, namely derivation and analogies, which are described and analyzed below.

➤ *Derivation (logic/deductive reasoning)*

The idea of proof is in the core of mathematical reasoning. This notion, which was mainly developed by the Greek philosophers, involves starting from an "evident" set of axioms and, by logical deductions, being able to prove a certain theorem. This style of reasoning is widely used and exemplified in Euclid's Elements and can also be found in several Physics' masterpieces, such as Newton's Principia and Einstein's work on Special Relativity. In fact, Einstein explicitly mentioned the similarity between geometry and theoretical physics by saying that:

The theorist's method involves his using as his foundation of general postulates or principles from which he can **deduce** conclusions. His work thus falls into two parts. He must first discover his principles and then draw the **conclusions that follow from them** (Einstein, 1934, pp. 110, our emphasis).

Therefore, being able to fully understand logical derivations of formulas is an important ability which allows one to recognize how physical assumptions, such as the principles of minimal action or energy conservation, are "imposed" by physics during these derivations. Even though this approach was much less common during the lessons, we were also able to find moments where it was explicitly discussed.

*D1: Can you demonstrate this equality from a mathematical point of view? The answer is no!*

During a certain lesson of the Special Relativity course, the goal was to derive an expression which could transform the expressions of the electric and magnetic fields in a frame of reference to another which was moving uniformly relatively to the first. This was the answer given by the professor when one student demanded a mathematical reason for a particular equality during the derivation. The professor explained that the physical condition imposed is that the electromagnetism is covariant, i.e., that Maxwell's equations should have the same form in both frames. Therefore, the reason for assuming that two expressions should be equal comes from a physical principle and not from logical reasoning.

*D2: We can show that this law (Gauss') is more general. We can derive Coulombs' law from Gauss'. We show where does  $4\pi$  comes from.*

The emphasis on the words *show* and *derive* are evidences that the deductive aspect of physics is being approached. The greater generality of Gauss' law is expressed when the professor mentions that it can be used to derive Coulombs' law and to show where the *mysterious*  $4\pi$  comes from. Accordingly, Feynman (1965, pp. 26-3) states that "the real glory of science is that we can find a way of thinking such that the law is evident".

We strongly believe that derivations enhance students' knowledge about the origin of physics' equations, allow them to penetrate into the inner structure of physics' reasoning and avoid the rote memorization of senseless mathematical formulas. However, it should be conducted very carefully and consciously, justifying every step by mentioning each physical imposition, so that it doesn't become an artificial set of logical steps for the students.

➤ *Analogies (hidden similarities)*

Noticeably, one of the most fruitful resources of reasoning in physics is analogy, since the relation between the model and the modelled phenomenon is generally analogical. According to Hesse (1953, pp. 202), "an analogy in physics is a relation, either between two hypotheses, or between a hypothesis and certain experimental results, in which certain aspects of both relata can be **described by the same mathematical formalism**". In this sense, Steiner (1998, pp. 3) defends the idea that "the only way scientists found to arrive at the atomic and subatomic laws of nature was through mathematical analogies".

The discussion of formal similarities and the identification of unifying mathematical structures highlight the importance of analogical reasoning for physics' students and was also found in several moments of the lessons.

*A1: Today we learned some strategies to deal with distributions of things. This is very general, it can be with charge, mass, population, anything that needs to be distributed.*

*A2: The mathematics of these two equations is the same.*

At the end of the lesson on the mathematical description of charge distribution, the professor wanted to make clear that the strategy learned for that purpose was general and could be applied in other several cases. This conscious remark reflects his intention of catching students' attention for the role of analogical reasoning in physics.

*A3: Is there a Gauss' law for gravitation? Yes. What is the flux of  $g$  through this mathematical surface? It is the Earth's mass. Which is the analogue to mass in Gauss' law? The charge!*

*A4: Every time you work in hydrodynamic – bees, water air – the flux is something that passes through a surface. They took this mathematical formulation to use in many other cases. But there are important differences. The electrical field doesn't really flow, it doesn't have any velocity.*

Once again the intention of establishing connections and identifying hidden similarities becomes evident. In both cases, different physical contents are exposed to underline the formal similarities between them. However, it is important to notice that not only similarities but also differences are stressed, like in the case of the water flux having a velocity and electrical field not.

## Preliminary conclusions and perspectives

Our main result so far is the set of four structural skills, which were defined and exemplified. However, it seems that there is a significant difference between them, since *mathematizing* and *interpreting* were found in almost every lesson, whereas *derivation* and *analogies* took place in crucial points. In order to better resolve these differences we intend to analyze the interplay between the categories using a time scale. We are interested in investigating how does the professor switch from one approach to another and how much time is dedicated to each skill along the whole course.

The presented paper is part of an ongoing PhD research in Physics Education. Due to the concrete examples and the identified categories concerning the structural approach of mathematics in physics lessons, the conducted case-study turned out to be an appropriate strategy.

## Acknowledgements

We thank CAPES and DAAD for the financial support of this research.

## References

- Einstein, A. (1934) *Mein Weltbild*. Amsterdam: Querido Verlag.
- Feynman, R.P.; Leighton, R.B.; Sands M. (1965) *The Feynman lectures on physics*, Addison-Wesley.
- Galilei, G. (1864) *Il Saggiatore*. Firenze: G. Barbèra Editore.
- Hesse, M. B. (1953) Models in Physics. *The British Journal for the Philosophy of Science*, 4(15), pp. 198-214.
- Hestenes, D. (2003) Oersted Medal Lecture 2002: Reforming the mathematical language of physics. *Am. J. Phys.* 71 (2), pp. 104-121.
- Kline, M. (1960) *Mathematics and the physical world*. London: John Murray (Publishers) Ltd.
- Pietrocola, M. (2008) Mathematics as structural language of physical thought. VICENTINI, M. and e SASSI, E. (org.). *Connecting Research in Physics Education with Teacher Education* volume 2, ICPE – book.
- Poincaré, H. (1958) *The Value of Science*. New York: Dover Publications.
- Redish, E. (2005) Problem solving and the use of math in physics courses. Invited talk presented at the conference, *World View on Physics Education in 2005: Focusing on Change*, Delhi.
- Steiner, M. (1998) *The Applicability of Mathematics as a Philosophical Problem*. Cambridge, MA: Harvard University Press.

## Building quantum formalism in upper secondary school students

Marisa Michelini  
marisa.michelini@uniud.it

Lorenzo Santi  
lorenzo.santi@uniud.it

Alberto Stefanel  
alberto.stefanel@uniud.it

Physics Department, University of Udine, Italy

### Introduction

The mathematical formalism in quantum mechanics (QM) has a conceptual role, as historical and fundamental researches tell us (Auletta 2001; Styer et al. 2002; Newton 2004 Ghirardi 2004). Considering that several national curricula include QM (Cern 2002), teaching QM in upper secondary school cannot leave out of consideration the interconnection between formalism and concepts. In spite of this, even though research document students conceptions on QM (Zollman 1999), the role of formalism is concerned only in few outcomes.

Müller -Wiesner (2002) found out that students, following a traditional path, interpret  $\Delta x$  and  $\Delta p$  in the Heisenberg relations prevalently as: measurement, indeterminacy or disturbance. Similar results were obtained by Fletcher-Johnston (1999), which in addition specified that 90% of their sample of students “are not seeing uncertainty as a new concept”.

Niedderer’s group found out a “rather low level” of qualitative understanding of the wave function and of the Schrödinger equation. Typical student sentences sound like: “*The electron is in no position, its position can be described approximately by psi*”. The implied link between  $\Psi(x)$  and position was also analyzed: only about  $\frac{1}{4}$  of the sample used the wave function concept according to QM,  $\frac{1}{2}$  used prevalently a pure classical trajectory conception,  $\frac{1}{4}$  used some intermediate conception with elements of trajectory and statistics (Niedderer et al. 1995). The students' approaches to probability in QM are: algorithmic (instrument to solve problems); causal descriptive (understanding of the probability distributions as a step by step reconstruction); probability as inaccuracy (Niedderer et al. 1999). Bao and Redish (2002) evidenced a connection between difficulties about probabilistic interpretation of psi and a poor comprehension of classical probability. The Maryland PERG also found that many college students attribute a materialistic nature to the wave function (Steinberg et al. 1999). Singh (2001) stressed the difficulties of college students in: the use of the superposition principle, attributing a meaning to the wave function, distinguishing the state, its formal representation, the eigenvalue associated to it.

Starting from this scenario, several studies were carried out in Italian pilot classes on how upper secondary students construct quantum concepts (Stefanel 2001; Michelini 2008; Michelini et al. 2004; Michelini, Stefanel 2008, 2010), following a learning/teaching proposal on QM, developed in previous research (Ghirardi et al 1995,1997; Michelini et al. 2000).

The study here presented aims at showing how students face the quantum formalism and interconnect it with concepts.

### 2. Research questions

The present study focuses on the following research questions.

**RQ1.** How do students link concepts and the corresponding formal representation?

We are interested in what activates this link in particular about: the probabilistic interpretation of quantum measurements; the vector representation of a state and the superposition principle; the meaning of eigenvalue/eigenvector.

**RQ2.** How do students use quantum formalism to represent concepts?

Our goal is to explore how students manage and/or use a very basic formalism going deep into quantum concepts.



**RQ3.** Which mathematical aspects are resonant with students way of thinking/communicating QM? Our objective is to individuate which formal aspects can be more useful in conceptual organization of students .

### 3. Instruments, Methods, Context

We used eight different instruments to carry out the experiment, collected data and followed the students' learning processes. Here we will discuss in particular: Educational path; Worksheets for students; Pre/Post test; Final written composition made by students.

**3.1 Educational path.** The educational path introduces the basic QM formalism according to a Dirac approach presented in several papers (Ghirardi et al. 1995, 1997; Michelini et al. 2000; Michelini, Stefanel 2004; Michelini 2008). It aims at constructing the fundamental quantum concepts with: a vertical development, from phenomenology to formalism; an horizontal development, from the bi-dimensional vectorial space of light polarization (Michelini, Stefanel 2006), to generalization (Michelini, Stefanel 2004; Michelini 2008, Michelini et al. 2008). Here we focus on the steps related to the introduction of formalism.

The first step is the representation of the photon polarization state with an arrow. This arrow, treated as a vector, can be used to evaluate the probabilistic measurement previsions (Malus law), using a (squared) scalar product. Mutually orthogonal vectors are associated to states related to mutually exclusive polarization properties. The formal representation of the quantum linear superposition principle emerges as an expansion of a polarization state vector  $\mathbf{u}$  using two orthogonal state vectors  $\mathbf{h}$  and  $\mathbf{v}$ :  $\mathbf{u}=\psi_1\mathbf{h}+\psi_2\mathbf{v}$ . The amplitudes  $\psi_1$  and  $\psi_2$  are associated to the probability of transition from  $\mathbf{u}$  to  $\mathbf{h}$  (and  $\mathbf{v}$ ) states and give an alternative representation of states (the wave function formalism). Starting from this representation the non classical nature of quantum probability (quantum interference) emerges. Using the concepts of orthogonal states and the scalar product, the formal results are generalized just by running the index  $n$  from 1 to  $\infty$ .

The last step suggests to analyze a Polaroid as a selector of state, represented by a projector of vectors, then construct a more general operator:  $\hat{O}=\rho_1\mathbf{hh}\cdot+\rho_2\mathbf{vv}\cdot$ , useful to evaluate the expectation value of quantum observables (as polarization). The generalization of these results completes the path.

**3.2 Worksheet for students.** Five inquiry worksheets (WS) are used by students during the activity (Michelini M. et al. 2008): WS1-2-3 aim at exploring and constructing concepts; W4-5 aim at bridging concepts and formal representation. Table I summarizes objectives and main knots of WS4-5.

WS4 – Vectors and quantum states Knots	WS5 - Linear operators and physical observables Knots
<ul style="list-style-type: none"> <li>• Probabilistic interpretation of Malus law and the square of scalar product</li> <li>• State vector</li> <li>• Superposition principle</li> <li>• Role of probability amplitude</li> <li>• Quantum interference</li> <li>• Conclusions</li> </ul>	<ul style="list-style-type: none"> <li>• Superposition principle resume</li> <li>• Polaroid as projectors</li> <li>• Projectors: <math>\mathbf{vv}\cdot</math>, <math>\mathbf{hh}\cdot</math></li> <li>• Operator: <math>\hat{O}=[g1(\mathbf{vv}\cdot)+g2(\mathbf{hh}\cdot)]</math></li> <li>• Linear operators and physical observables</li> <li>• Expectation value of an observable</li> <li>• Eigenvectors and Eigenvalues of a linear operators</li> </ul>

Table 1. The conceptual knots considered in the worksheets WS4 and WS5.

**3.3 The Test.** The questionnaire, used as pre/post test, provides 15 items: 2 open-ended questions, 13 multiple choice questions (only an exhaustive answer) and the choice explanation. The first seven questions are about concepts, and were discussed in previous works (Michelini, Stefanel 2008, 2010); other three questions are about the photon phenomenology; the remaining five questions are about the formalism. Here we focus on item 8, about the probabilistic interpretation of  $\Psi$ , and on the item 14, about the physical meaning of eigenstates and eigenvectors.

**3.4 The final examination simulation.** Two months after the end of the experimentation, the following open-ended question was posed during an official simulation of the final examination:

*Discuss the meaning of the association operator-physical observable in QM, in particular showing: the role of operators in the evaluation of the expectation value of a physics observable of a system; the meaning of eigenvalues and eigenvectors of the operator.*

**3.5. Analysis methodology.** The frequency of answers was evaluated for multiple choice questions. The open answers, including the final written composition, were analyzed in three steps: individuating the answer categories; classifying each answer in a category according to the main elements; evaluating the frequency for each category.

**3.6 The context.** The educational path was proposed to 17 students, 18 years aged, in a final year class of an upper secondary school in Udine. Our sample, the same of a previous work focused on conceptualization (Michellini, Stefanel 2010), is composed by the 16 students attending the entire module. According to the teacher initial evaluation, the level of students was middle-high; they attended a five years course of physics, having experience in the construction of concepts from experiments, knowing polarization phenomenology.

## 4. Data and results.

**4.1 WS4-Steps1-2.** Students consider the following situation: a photon beam interacts with two Polaroids aligned with the beam. They are requested to A) evaluate the probability  $P$  of photon transmission and B) correlate it with the scalar product of the unit vectors  $\mathbf{U}$  and  $\mathbf{W}$ , forming an angle  $\theta$  and representing the permitted directions of each of the two Polaroids. Then C) they are suggested to represent the state of the photon transmitted by the first Polaroid with a vector  $\mathbf{u}/U$  and D) are requested to indicate if this association is sufficient to reproduce the experimental results and E) if the unit vector  $\mathbf{u}$  can be effectively used to represent the photon state.

A) All students evaluated  $P$  as  $P=\cos^2\theta$ , B) connecting this results with  $(\mathbf{U}\cdot\mathbf{W})^2$  (11/16 of students), or repeating  $\cos^2\theta$  (5/11); C) choice that photon state is defined only by  $\mathbf{U}$  (16/16). D) They consider sufficient the association state and  $\mathbf{u}$  vector to reproduce the experimental results. E) The motivations categories exemplify three ways of students' approaches to formalism: G1) geometrical modality, the framework is the elementary plane geometry ("Yes, we need to know only the angle") (8/16); physics/operative correspondence, the reference is a physical apparatus ("Yes, because the first Polaroid does not depend on the second") (5/16); G3) sentence/conceptual modality, the reference is the state concept ("When I know the photon state, I can reproduce the experimental results for each Polaroid orientation") (3/16).

**WS4-Step3.** The question posed to students is: "The probability  $P$  represents the probability of transition between the two states of the photon: Clarify this assertion in light of the basic formalism that has been introduced". The emerged categories of answers are: A) formula-" $P=(\mathbf{U}\cdot\mathbf{W})^2$ " (2/16); B) Mix of G1-geometrical and G3-conceptual modalities-"The probability  $P$  is represented by the probability of a photon to make a transition from state  $\mathbf{U}$  to state  $\mathbf{W}$  in relation to the transmission angle  $\theta$ " (3/16); C) G3-conceptual modality-"If the photon is transmitted, it makes a transition to the  $\mathbf{w}/W$  state; if it is not transmitted, it makes a transition to the state mutually exclusive with respect to the  $\mathbf{w}/W$  state" (5/16); D) no answer (6/16).

**WS4-Conclusions.** At the end of the worksheet, students are requested to: A) "Resume the conclusions obtained in this worksheet discussing briefly the case of the  $45^\circ$  polarization state (represented by vector  $\mathbf{u}_{45}$ ), considered as superposition of  $h$  and  $v$  states, represented by  $\mathbf{h}$  and  $\mathbf{v}$  unit vectors"; B) "Conclude resuming the physics meaning of the superposition principle and its formal expression".

Students did not answer to each question separately, but with a single sentence for the two, referring to light polarization. Four categories of answers are recognized: CA) Superposition (" $\mathbf{U}_{45}=\Psi_1\mathbf{v}+\Psi_2\mathbf{h}$ : the unit vector  $\mathbf{u}$  can be seen as superposition of  $\mathbf{v}$  and  $\mathbf{h}$ . The product  $\mathbf{u}\cdot\mathbf{u}=1$ .  $\Psi_1$  e  $\Psi_2$  characterize all the possibilities of the photon that is in a superposition of states" (6/16); CB) Formula (incomplete/incorrect) (2/16); CC) Sentence ("The vector  $\mathbf{U}_{45}$  must be considered as a state

of superposition of states represented by mutually exclusive vectors ( $\mathbf{h}$ ,  $\mathbf{v}$ )" (6/16); No answer (2/16).

**4.2 WS5** –We consider only the following question: “Do you recognize a correlation from this formal result [a projector acting on a vector] and the action of a Polaroid on a photon beam prepared in a state represented by  $\mathbf{u}$ ’, when the permitted direction of the Polaroid is along  $\mathbf{V}$ ?”.

The category of students answers are: O1) functional link (5/16)-"Yes, because through the polaroid pass only photons with  $v$  polarization and  $(\mathbf{v}\mathbf{v}\cdot)$  projects  $\mathbf{u}$  on  $\mathbf{v}$ . In both cases the photons in the orthogonal states do not pass"; O2) Identification (4/16)-"it represents probably the phenomenon of polarization..."; O4) Geometrical (4/16)- "Bigger is the angle between  $\mathbf{u}$  and  $\mathbf{v}$  (lower is the projection), lower will be the probability that the photon will be transmitted"; O4) Change of state (2/16)-"the polaroid makes photons change from state  $\mathbf{u}$  to state  $\mathbf{v}$ "; O5) No answer (1/16).

**4.3 Test.** For what concerns item 8, all students, after the module, associated  $\Psi(x)$  to a probabilistic information. For what concerns item 14, students prevalently recognized the physical meanings of eigenvectors (13/16), and only in few cases considered eigenvectors as particular states of the system that are rarely realized (2/16), generic states of the system (1/16). Students considered eigenvalues as: numbers associated to the probability to obtain the results of the measurement of an observable  $A$  (8/16); numbers that do not have immediate physical meaning (2/16); the possible values that are obtained measuring an observable  $A$  (5/16). Only less than 1/3 recognized the meaning of eigenvalues, emerging prevalently as an association with probability.

**4.4 Simulation of the Final Examination.** From the final open written composition we just resume some results: about 60% of the sample shows competence in autonomously managing operators, recognizing their role in QM; a large majority of students was able to identify what an eigenvector is, prevalently associating to it its physical meaning (Eigenvectors are: "possible states" "after the measurement" (9/16)) or its geometrical interpretation ("Eigenvectors are the vectors that, applied to the operator, results in the vectors themselves multiplied by some values" (8/16)). 11/16 students recognized also the role of eigenvalues (a better performance than the one of the test); only 5/16 identified eigenvalues with probability amplitudes, states, expectation values.

## 5. Conclusions

A study on how upper secondary school students face quantum mechanics formalism was conducted with 17 *eighteen year old students*, in a class of an Italian school. The educational path proposed a research based on the Dirac conceptual approach to quantum theory and his basic formalism, starting from polarization phenomenology and generalizing the results in other contexts. The data were collected from different sources: worksheets filled by students; pre/post test; a written composition made by students during the simulation of the final examination.

From data it emerges that students do not have difficulties to analyze the phenomenology of polarization and to manage the related two-dimensional vector space. Students need a phenomenological context, in order to anchor their conceptual and formal thinking development and where they can recognize the plausibility and the meaning of the introduced formal instruments/tools. These processes emerged when students linked probabilistic previsions and scalar product, Polaroids, projectors. Nevertheless, students needed to explore different phenomenologies to generalize what they learn in the anchoring context. In our study the learning outcomes were mainly referred to the anchoring context of polarization (**RQ1**).

We individuate four modalities about how students approach and use the formalism (**RQ2**):

- The **formula modality** (The quantum rules are reduced to a mathematic formula)
- The **geometrical modality** (The quantum rules acquire meaning because they can be geometrically interpreted)
- The **descriptive/conceptualized modality** (The need to give a description in words of quantum rules and concepts prevails on their formal representation)
- The **physics correspondence** (between quantum concept and mathematic representation)

The students approaching formalism according to the first modality, evidenced initially a geometrical modality. They did not evidence effective connection between concept and formalism. The second and third modalities are natural ways of thinking for some students, appearing as bridges toward the construction of a mathematical representation of concepts in many cases.

The mathematical aspects resonating with students way of thinking (**RQ3**) are: the scalar product and the probability of transition; the state vector and the linear combination of the superposition principle;  $\Psi$  to correlate vectorial formalism and probability of transition; eigenvectors as possible states after a measurement. On the other side, the eigenvalue concept and the explicit link between mutual exclusive properties and orthogonal states are the main critical formal aspects. It seems to be related to the geometrical/concrete modality by which the formalism is approached.

## References

- Aiello Nicosia M. L. et al. (1997) *Teaching mechanical oscillations using an integrated curriculum*, IJSE, 19, 8, 981-995
- Auletta G. (2001) *Foundations and Interpretation of QM*, Singapore: World Scientific.
- Bao L., Redish EF (2002) Understanding probabilistic interpretations of physical systems: A prerequisite to learning quantum physics, *AJP* 70 (3), 210-217
- Cern (2002) <http://teachers.web.cern.ch/teachers/archiv/HST2001/syllabus/syllabus.htm>
- Fletcher P., Johnston I. (1999) *Quantum Mechanics: exploring conceptual change*, in Zollmann D. Eds (1999), 28-31.
- Ghirardi G.C. (2004) *Sneaking a look at God's Cards*, Princeton University Press USA.
- Ghirardi G.C., Grassi R., Michelini M. (1995) A Fundamental Concept in Quantum Theory: The Superposition Principle, in Carlo Bernardini et al. eds. *Thinking Physics for Teaching*, NY: Plenum, 329-334.
- Ghirardi G. C., Grassi R., Michelini M. (1997) Introduzione delle idee della fisica quantistica e il ruolo del principio di sovrapposizione lineare, *LFNS*, XXX, 3-Sup., Q7, 46-57.
- Michelini M. (2008) Approaching the theory of QM, in *Frontiers of Physics Education*, R.Jurdana-Sepic et al eds., Rijeka: Zlatni, 93-101
- Michelini M., Ragazzon R., Santi L., Stefanel A. (2000) Proposal for QM in secondary school, *Phys. Educ.* 35 (6) 406-410.
- Michelini M., Ragazzon R., Santi L., Stefanel A. (2004) Discussion of a didactic proposal on QM with secondary school students, *Il Nuovo Cimento*, 27 C, 5, 555-567
- Michelini M., Santi L., Stefanel A. (2008) Worksheets for pupils involvement in learning QM, in *Frontiers of Physics Education*, Jurdana-Šepić R. et al eds., Rijeka: Zlatni, 102-111
- Michelini M., Stefanel A. (2004) *Avvicinarsi alla Fisica Quantistica*, Udine: Forum.
- Michelini M., Stefanel A. (2006) Hands-on sensors for the exploration of light polarization, in G. Planinsic, A Mohoric eds, *Informal Learning and Public Understanding of Physics*, Ljubljana: Girep, 202-208
- Michelini M., Stefanel A. (2008) Learning Paths Of High School Students In QM (2008), in Jurdana-Sepic R., in *Frontiers of Physics Education*, Rijeka: Zlatni, 337-343
- Michelini M., Stefanel A. (2010) in Santoro G. ed, *New Trends in Science and Technology Education*, Bologna: Clueb, 307-322.
- Müller R, Wiesner H (2002) Teaching QM on an introductory level, *AJP* 70 (30), 200-209
- Newton R.G. (2004) What is a state in quantum mechanics?, *AJP* 72 (3), 348-350.
- Niedderer H., Bethge T, (1995) *Students' conceptions in quantum physics*, University of Bremen.
- Niedderer, H., Deylitz, S. (1999) *Evaluation of a new approach in quantum atomic physics in high school*. In D. Zollman (Ed.), 23-27
- Singh, C. (2001) Student understanding of quantum mechanics. *AJP*, 69 (8), 885-895
- Stefanel A. (2001) Interazione di fotoni con polarizzatori e cristalli birifrangenti per l'introduzione del concetto di stato quantico, *LFNS*, XXXIV, 1-supplemento.
- Steinberg R., Wittmann M. C., Bao L. and Redish E. F. (1999) *The influence of student understanding of classical physics when learning quantum mechanics*, in D. Zollman (Eds) (1999), 41-44.
- Styer D.F. et al. (2002) Nine Formulations of Quantum Mechanics, *AJP* 70, 288-297
- Zollmann D. Eds. (1999) *Research on Teaching and Learning QM*, NARST, [www.phys.ksu.edu/perg/papers/narst/](http://www.phys.ksu.edu/perg/papers/narst/).

# Mathematics as a resource in understanding the peculiar characteristics of magnetic field

Carlo Cecchini<sup>1</sup>  
cecchini@dimi.uniud.it

Marisa Michelini<sup>2</sup>  
marisa.michelini@uniud.it

Lorenzo Santi<sup>2</sup>  
santi@fisica.uniud.it

Stefano Vercellati<sup>2</sup>  
stefano.vercellati@uniud.it

Mathematics<sup>1</sup> and Physics<sup>2</sup> Department, University of Udine, Italy

## Abstract

Despite that mathematics is the basic language used by physicist to construct formal entities, at high school level sometimes this is poorly implemented, as the case of the naïve definitions of important entities like the pseudovector (axial vector) and the limited use of the study of the symmetries for example in the analysis of electromagnetic systems. In this paper two simple experimental contexts are proposed in which students investigate the pseudovectorial nature of electromagnetic field vector and a simple formal explanation of its nature starting from the analysis of its behavior.

## Introduction

Mathematics provides to physicists powerful ways to describe the phenomenological world through formal entities, with properties that constitute tools for the analysis and allows researchers to deduce important conclusions starting from the individuation of simple elements observable into the physical systems. In particular, in this framework, one of the most important theoretical tool is the Neother's first theorem (Noether et al 1918) that, in its simplest formulation, relates the presence of symmetries in a physical system to conservation laws: symmetries in classical and modern physics have a pivotal role in the description of the physical systems, so the knowledge of how formal entities are transformed by symmetry operation is crucial (Foot & Volkas, 1995; Kozlov & Valerij, 1995; Mohapatra & Senjanovi'c, 1981; Redlich, 1984).

The role of symmetries in high school physics education is often underestimated and this is due to a not so strictly definition of the formal entities, that points only to the definition of the structure of the entities and not to the way in which these entities are transformed by symmetry operations. The main example is the definition of 'vector', without stressing the difference between polar and axial vector. This distinction becomes relevant only in the higher level courses, creating so an intellectual gap between student's studies in undergraduate and graduate mathematics (Kolecki, 2002). In the student learning path, this gap seems to be a "no man's land" and represents a huge difficulty for students, so a specific activity that allows students to face the difference between axial and polar vectors has to be introduced.

To analyze the symmetries of the electromagnetic system is pivotal to know the transformation properties of the electromagnetic quantities under space inversion, charge conjugation and time reversal (Rosen, 1973). In particular Pierre Curie (1894) was one of the first scientists that demonstrate that the electric and magnetic vectors are transformed in a different ways under the space inversion highlighting the different nature of the two vectors: electric field vector transforms as a "normal vector" (as position, velocity and acceleration vectors) and the magnetic field vector (Roche, 2001) transform as an axial vector -or pseudovector- (as angular momentum vector).

In this work, that is a part of a larger work of research, we highlight the role of the formalism in the description of a quantity such as the magnetic field vector  $\vec{B}$ , proposing two experimental context in which its pseudovectorial nature its explored.

### Experimental exploration of the pseudovectorial nature of the magnetic field vector

We propose two contexts to introduce at high school student level the idea of the magnetic field vector as a pseudovector entity: the study of the magnetic field generated by a coil and the study of the effect of the magnetic field on a moving point charge (Lorentz force).

In the case of the magnetic field generated by a coil, experimentally, we observe experimentally that a compass set in the center of the coil indicates the presence of a magnetic field having direction coincident with the axis of the loop and the versus given by the right-hand rule.

In a reference system with the  $xy$  plane parallel to the plane of the coil, we investigate the transformation proprieties of the formal entities describing the system.

In particular, let us consider the magnetic field vector in the center of the coils ( $\vec{B}$ ) and a general position vector  $\vec{p}$  (as shown in Figure 1a). After rotating the system around the  $x$  axis, the compass shows that the magnetic field vector in the centre of the coils transforms in the same way of the position vector (Figure 1b).

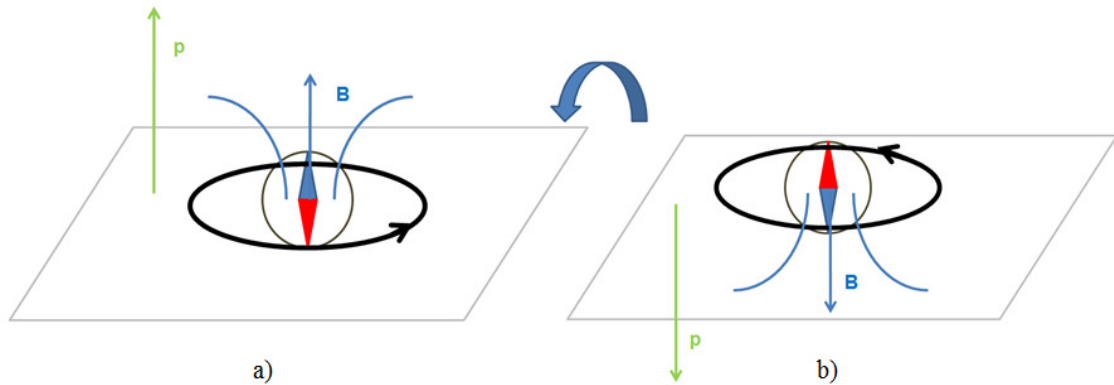


Figure 1: Rotation of a coil

If we consider instead a specular reflection transformation of the system respect to the  $xy$  plane, the compass shows that the transformation rule of the magnetic field under this symmetry transformation differs from the transformation rule for the position vector (Figure 2b).

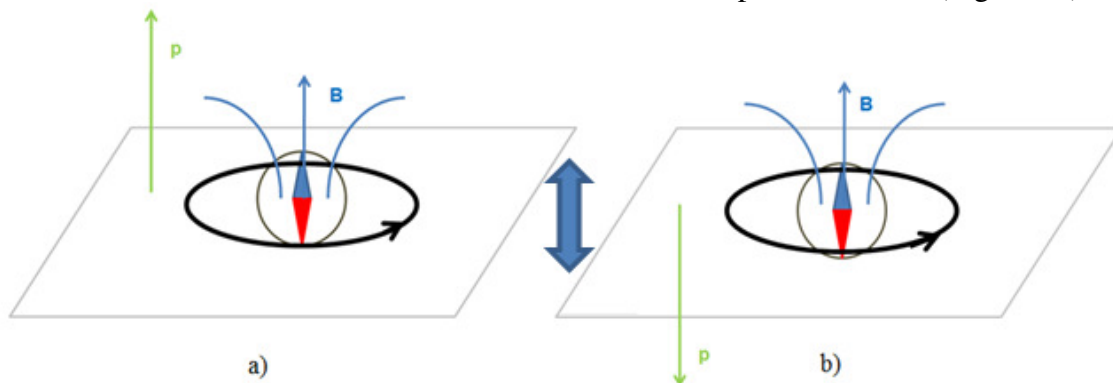


Figure 2: Symmetry transformation of coil

The case of the Lorentz force can be experimentally explored considering a moving charge between two Helmholtz coil. If any dissipation phenomena is neglected, the motion of charge can be one of the following three types: circular uniform, helicoidally uniform (with step, radius and speed of traveling constant) or rectilinear uniform.

In each one of these types the magnitude of the charge speed is constant during the motion, while the type of trajectory depends on the orientation of the starting velocity. In addition, the examination of the phenomena leads to the conclusion that there is a force ( $\vec{F}$ ) acting perpendicular to the velocity vector ( $\vec{v}$ ):  $\forall \vec{v} \in \mathbb{R}^3 \quad \vec{F} \perp \vec{v}$  at every point of motion.

Moreover, because of the constant step of the helix, we deduce that the force acts only in the plane perpendicular to the axis of the helix, and the parallel velocity component to the helix remains constant. Also, depending on the motion of the charge, we see that the helix axis is parallel to the axis of the uniform circular motion and coincident with the direction of the rectilinear uniform one.

These results allow to individuate a constant entity built up from the relevant vectors dynamically describing the system:  $\frac{\vec{v}}{v} \times \frac{\vec{F}}{qv}$ . A simple reasoning shows that this vector is essentially equivalent to the magnetic field vector.

Rotating the system around the  $x$  axes (Figure 3), the magnetic field vector and a general position vector transform in the same way.

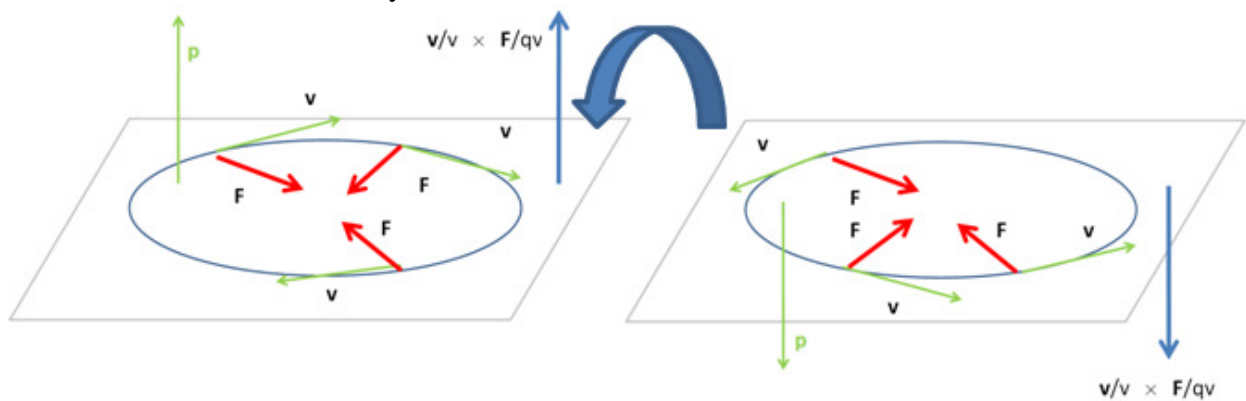


Figure 3: Rotation of a simple electromagnetic system

If we consider instead a reflection respect to the  $xy$  plane the two vectors transform in different ways.

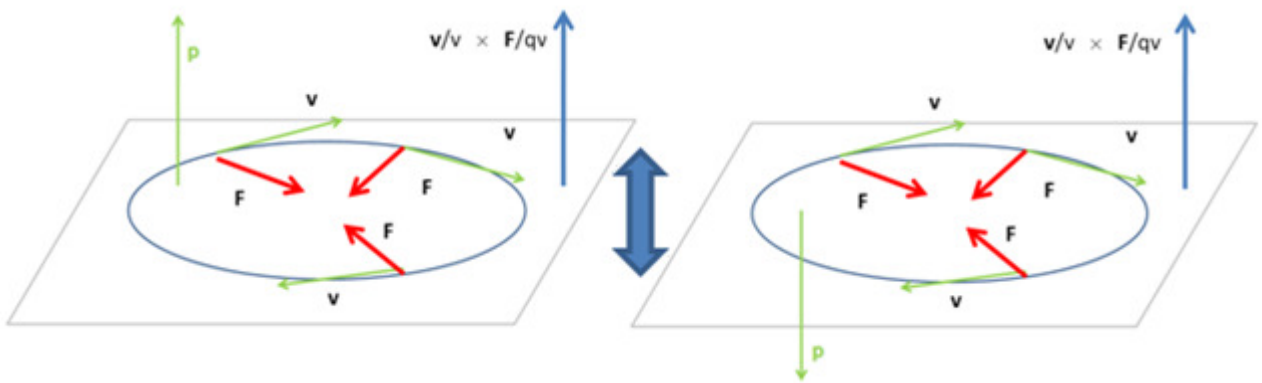


Figure 4: Symmetry transformation of a simple electromagnetic system

So, in these examples, the magnetic vector transforms “normally” under the rotations of the system, but not under reflections.

### Introducing pseudovector to high school students

In low level course physics, concerning three dimensional space, vectors are defined as abstract objects that are represented and characterized by: magnitude, direction, versus and (eventually) an application point. As concern operation with vectors, in particular, two external products are defined: the scalar product and the vector product. The first one associates to the two vectors a scalar quantity and the vector product associates to the two vectors a third vector (not belonging to

the initial vector space) and having perpendicular direction to the plane that carries the two starting vectors and its verse is established using the right-hand rule.

More formally, a vector  $\vec{v}$  is the element of a vector space, i.e. an object that can be added or subtracted to similar items and multiplied by the scalar. Given an n-dimensional Euclidean space and a set of n linearly independent vectors ( $\vec{u}_1 \dots \vec{u}_n$ ), any vector of the space can be written as a linear combination of these n linearly independent vectors:  $\vec{v} = a_1 \vec{u}_1 + \dots + a_n \vec{u}_n$ .

The  $\{\vec{u}_i\}$  set is called a complete base for the vector space considered and every vector of the space may be represent as the n-tuple of the real numbers  $\{a_i\}$  so  $\vec{v} \equiv (a_1, \dots, a_n)$ .

From the other side, geometric transformation as rotation and symmetry rotation are formally functions that map between two vector spaces (or - as in our case- from one vector space to itself) and, if we limit our analysis to the case of a linear transformations, they preserve the properties of the linear combinations of vectors. In particular linear geometric transformations can also be seen as a base change in the vector space.

If we use a different complete base, for example  $\{\vec{w}_i\}$ , we would have  $\vec{v}_w = b_1 \vec{w}_1 + \dots + b_n \vec{w}_n$  so  $\vec{v} = (b_1, \dots, b_n)$ .

In particular:

$$\begin{aligned} \vec{v}_w &= b_1 \sum_{i=1}^n c_{1i} \vec{u}_i + \dots + b_n \sum_{i=1}^n c_{ni} \vec{u}_i = \sum_{i=1}^n b_1 c_{1i} \vec{u}_i + \dots + \sum_{i=1}^n b_n c_{ni} \vec{u}_i = \sum_{j=1}^n \sum_{i=1}^n b_j c_{ji} \vec{u}_i \\ &= \sum_{j=1}^n \sum_{i=1}^n c_{ji} (b_j \vec{u}_i) = \sum_{j=1}^n \sum_{i=1}^n c_{ji} \vec{v}_w = \begin{pmatrix} c_{11} & \dots & c_{1n} \\ \vdots & \ddots & \vdots \\ c_{n1} & \dots & c_{nn} \end{pmatrix} \begin{pmatrix} b_1 \\ \vdots \\ b_n \end{pmatrix} = \vec{v}_w \end{aligned}$$

So linear geometric transformations can also be seen as a base change in the vector space. In particular, they can be represented by a matrix in the case of a transformation that maps from a space in itself.

In the case that the two bases  $\{\vec{w}_i\}$  and  $\{\vec{u}_i\}$  are orthogonal, the  $\{c_{ij}\}$  matrix is also orthogonal; i.e. it is a square matrix with real entries whose columns (and rows) are orthogonal unit vectors. In particular the determinant of this type of matrix is equal to  $\pm 1$

A reflection respect to a particular plane is a transformation of the vector space in itself (endofunction and isomorphism) that maps every single point of the vector space in one and only one point of the same space (bijective) without altering the distance between two starting points and the two reflex points (isometric).

So is possible to define a linear application  $f$ , representable as a matrix, that connect to each point  $P$

of the space to his transformed and result for reflection  $\vec{f}(\vec{P}) = \begin{pmatrix} 1 & 0 & 0 \\ 0 & 1 & 0 \\ 0 & 0 & -1 \end{pmatrix} \begin{pmatrix} P_x \\ P_y \\ P_z \end{pmatrix} = \begin{pmatrix} P_x \\ P_y \\ -P_z \end{pmatrix}$  and

for the considered rotation  $\vec{f}(\vec{P}) = \begin{pmatrix} -1 & 0 & 0 \\ 0 & 1 & 0 \\ 0 & 0 & -1 \end{pmatrix} \begin{pmatrix} P_x \\ P_y \\ P_z \end{pmatrix} = \begin{pmatrix} -P_x \\ P_y \\ -P_z \end{pmatrix}$ .

We notice that the first matrix as determinant equal to  $-1$  and the second one has determinant  $+1$ .

Experimentally we observe the strange behavior in the case of reflection, and in particular, considering other type of transformation, can be show that for all transformation that has a representative matrix having determinant equal to  $+1$ , the magnetic field vector transform as a 'normal vector', for the other (that have determinant equal to  $-1$ ) the transformation rules are different. In particular, concerning the reflection respect to the xy plane, experimentally:

$$\begin{pmatrix} B_x \\ B_y \\ B_z \end{pmatrix} \rightarrow \begin{pmatrix} -B_x \\ -B_y \\ B_z \end{pmatrix} \text{ while if we apply the "standard" rule: } \begin{pmatrix} 1 & 0 & 0 \\ 0 & 1 & 0 \\ 0 & 0 & -1 \end{pmatrix} \begin{pmatrix} B_x \\ B_y \\ B_z \end{pmatrix} = \begin{pmatrix} B_x \\ B_y \\ -B_z \end{pmatrix}.$$



Since  $\vec{B}$  behaves differently from  $\vec{v}$  under particular transformation, they must be two different formal entities and this difference is highlighted in these particular context.

We go now to investigate the formal nature of  $B$ . Considering a coil carrying a uniform electric current oriented in any way in space (relative to a orthonormal reference system  $xyz$ ), from the Biot-Savart law the magnetic field vector is defined as:

$$\vec{B} = \frac{\mu_0}{4\pi} \int \frac{I d\vec{l} \times \hat{r}}{r^2}$$

That in the case of the magnetic field generated in the center of the coil, can be rewritten as:

$$\vec{B} = \frac{\mu_0 I}{4\pi r^2} \int d\vec{l} \times \hat{r} = \frac{\mu_0 I}{4\pi r^2} 2\pi r (d\vec{l} \times \hat{r}) = \frac{\mu_0 I}{2\pi r} (d\vec{l} \times \hat{r})$$

Posing  $k \equiv \frac{\mu_0 I}{2\pi r}$ , we obtain  $\vec{B} = k(d\vec{l} \times \hat{r})$ .

To discover the nature of  $B$  we must then go to investigate the nature of the vector product  $d\vec{l} \times \hat{r}$ .

The vector product is usually defined as an application that maps from  $(\mathbb{R}^3 \times \mathbb{R}^3)$  in  $\mathbb{R}^3$  so at two vectors will be associated a third vector that does not belong in the starting space.

In particular the components of  $\vec{B}$  are of the type  $B_x = k(l_y r_z - l_z r_y)$  with cyclic permutation of the index. As can be seen the  $x$  component of  $\vec{B}$  depends only on the  $y$  and  $z$  components of the vectors  $\hat{r}$  and  $\vec{l}$ . To emphasize this fact we can propose a change of notation:  $B_{yz} \equiv B_x$  (and similar).

Calculating all possible  $B_{ij}$  values and grouping them into a matrix we obtain:

$$B = \begin{pmatrix} B_{xx} & B_{xy} & B_{xz} \\ B_{yx} & B_{yy} & B_{yz} \\ B_{zx} & B_{zy} & B_{zz} \end{pmatrix} = \begin{pmatrix} 0 & B_z & -B_y \\ -B_z & 0 & B_x \\ B_y & -B_x & 0 \end{pmatrix}$$

This new notation allows to rewrite the magnetic field as an antisymmetric matrix with zero trace, that is uniquely associable to a set of three numbers  $\{B_x, B_y, B_z\}$  that, in the three dimensional space, with an abuse of notation are usually graphically represented as a vector  $\vec{B}$  having components

$$\begin{pmatrix} B_x \\ B_y \\ B_z \end{pmatrix}$$

The advantage given by this new representation is strictly connected to the rule of transformation. In fact matrix under basic transformation, transform according to a rule that differs from the one used for the vectors. In particular they transform following the law  $B' = {}^T S B S$ ; where  $B'$  is the transformed of  $B$  and  $S$  is the usual transformation matrix for vectors and  ${}^T S$  is the transposed matrix of the matrix  $S$ . So, in the case of reflection,

$$B' = {}^T S B S = \begin{pmatrix} 1 & 0 & 0 \\ 0 & 1 & 0 \\ 0 & 0 & -1 \end{pmatrix} \begin{pmatrix} 0 & B_z & -B_y \\ -B_z & 0 & B_x \\ B_y & -B_x & 0 \end{pmatrix} \begin{pmatrix} 1 & 0 & 0 \\ 0 & 1 & 0 \\ 0 & 0 & -1 \end{pmatrix} = \begin{pmatrix} 0 & B_z & B_y \\ -B_z & 0 & -B_x \\ -B_y & B_x & 0 \end{pmatrix} \rightarrow \begin{pmatrix} -B_x \\ -B_y \\ B_z \end{pmatrix}$$

and in the case of rotation

$$B' = {}^T S B S = \begin{pmatrix} -1 & 0 & 0 \\ 0 & 1 & 0 \\ 0 & 0 & -1 \end{pmatrix} \begin{pmatrix} 0 & B_z & -B_y \\ -B_z & 0 & B_x \\ B_y & -B_x & 0 \end{pmatrix} \begin{pmatrix} -1 & 0 & 0 \\ 0 & 1 & 0 \\ 0 & 0 & -1 \end{pmatrix} = \begin{pmatrix} 0 & -B_z & -B_y \\ B_z & 0 & -B_x \\ B_y & B_x & 0 \end{pmatrix} \rightarrow \begin{pmatrix} -B_x \\ B_y \\ -B_z \end{pmatrix}$$

That are both consistent with the experimental exploration.

In the end, to find an agreement between experiment and theory, the magnetic field cannot be represented by a vector, but by a 3x3 matrix. Formally this is expressed by saying that the magnetic field is a tensor of order two.

## Conclusions

In the path we proposed, starting from experimental exploration of phenomena, the students face a situation in which the “standard” representation of the magnetic field fails and, through the use of the formal description provided by mathematics, they review the definition of the formal entity. In this way the experimental framework allows students to stress the difference between vector and pseudovector (i.e. polar and axial vector) and the formal approach applied to the specific situations allow them to bridge one of the main highlighted gaps in the student studies, providing them a formal description in which they face the ‘real’ formal nature of the magnetic field.

**Acknowledgment** to professor Pietro Corvaja and Sebastiano Sonogo (University of Udine – Departments of mathematics and physics) for the help and the fruitful discussions.

## References

- Foot R, Volkas R R, Neutrino physics and the mirror world: How exact parity symmetry explains the solar neutrino deficit, the atmospheric neutrino anomaly, and the LSND experiment, *Phys. Rev. D* 52, 6595–6606 (1995).
- Joseph C. Kolecki, An Introduction to Tensors for Students of Physics and Engineering, Tech. report, NASA Glenn Research Center, Cleveland, September (2002).
- Kozlov, Valerij V, Symmetries, topology and resonances in Hamiltonian mechanics, (Book) Berlin, Germany: Springer-Verlag, Inc , 1995.
- Mohapatra R N, Senjanović G, Neutrino masses and mixings in gauge models with spontaneous parity violation, *Phys. Rev. D* 23 (1981) 165.
- Noether E, Invariante Variationsprobleme. *Nachr. D. König. Gesellsch. D. Wiss. Zu Göttingen, Math-phys. Klasse* 1918: 235–257, (1918).
- Redlich A N, Parity violation and gauge non-invariance of the effective gauge field action in three dimensions, *Phys. Rev. D* 29 2366 (1984).
- Roche J, Axial vectors, skew-symmetric tensors and the nature of the magnetic field, *Eur. J. Phys.* 22 193 (2001).
- Rosen J, *Transformation Properties of Electromagnetic Quantities under Space Inversion, Time Reversal and Charge Conjugation*. American Journal of Physics, 1973. 41: p. 586-588.

## **The interplay of physics and mathematics in a graduate quantum mechanics course for physics teachers**

Bat-Sheva Eylon  
b.eylon@weizmann.ac.il

Elisheva Cohen  
elisheva.cohen@weizmann.ac.il

Esther Bagno  
esther.bagno@weizmann.ac.il

Department of Science Teaching, Weizmann Institute of Science, Israel

### **Abstract**

The present study was carried out in the context of a QM course for physics teachers participating in the Weizmann-Rothschild MSc program for excellent teachers. The physics courses in the program were especially designed for the teachers, and the interplay of mathematics and physics played a central role. The study investigated the goals of the course as conceived by the instructor, the intended plan for its implementation, the changes that were introduced along the semester in response to the feedback and the learning outcomes. The data-sources included observations, interviews, group discussion, oral and written feedback and a conceptual questionnaire based on the QMVI and the QMCS [1, 2]. The findings indicated that the instructor made a very clear distinction between the goals of this course and those of a graduate QM course for future scientists. The instructor reduced the level of mathematics and emphasized the conceptual ideas behind the mathematics ("developing sense of understanding"); he adapted a historical approach and elaborated on the logic behind the formulas. During the course both the instructor and the TA supported the teachers in mathematical aspects and responded dynamically to their needs by changing the assignments and the assessments. In spite of the reduced mathematical level, teachers' achievement in the conceptual questionnaire was similar to those of other groups reported in the literature. The teachers indicated that the course developed their confidence in coping with mathematical challenges and made them more aware of their students' needs.

### **Introduction**

Designers of advanced courses for physics teachers, who graduated from university many years ago, must address primarily teachers' mathematical knowledge. Instructors either adapt their teaching to this background or complement the essential mathematical knowledge as well as the skills needed to use this knowledge in physics. For example, in the Modeling project Hestenes, (2003), in order to describe physical events, teachers learn modeling skills. In addition, learning science involves interaction between physics and mathematics. However, both research and teaching experience indicate that learners, at all ages and levels, lack the ability to construct the mathematical models of physical processes or to describe the physical meaning of mathematical constructs. Clement et al. (1981) report on the pitfalls freshman engineering majors encounter when they are asked to construct equations to match situations described in words. Bagno et al. (2007) carried out diagnostic studies showing that high-school students face difficulties describing the physical meaning of formulas. Cohen et al. (1983), found that both high school students and their teachers often fail in qualitative

reasoning on DC circuits despite the fact that they are able to apply correctly the relevant mathematical algorithms. Rebmann and Viennot, (1994) discuss the difficulty of many university physics students in applying and interpreting algebraic sign conventions consistently in a variety of topics.

The study described in this paper was carried out in the context of the Rothschild-Weizmann MSc program for excellent teachers. This program was established to provide an opportunity for excellent active teachers to get advanced training in their disciplinary field and in science education. The program aims to promote teachers' enthusiasm and professional standing and to form a community of excellent leading science teachers. Presently the program operates in the fields of secondary physics, chemistry, biology and mathematics. The courses of the program have been especially designed for these teachers, and the role of mathematics and its interplay with physics has been a central issue that concerned the physics instructors in the program. In this paper we focus on the QM course given in this program to the first group of teachers.

## Research questions

1. What were the goals of the course and what was its intended content and pedagogy?
2. What were the changes in the course that were introduced along the semester?
3. What were the learning outcomes of the course?

## Method

### The Setting

**The Course:** The QM course was the first course in the 3 years program. It lasted 14 weeks - 4 hrs lecture and 1hr recitation each week. In addition, 3 PhD physics students served as tutors (1 tutor per 2-3 teachers), each week for 2 hrs. Before the course, the teachers attended a 20 hour workshop reviewing the mathematical background needed for the course. The teachers were required to hand in a total of 8 HW assignments.

**The Teachers:** Eight experienced high-school physics teachers participated in the course. They completed their formal studies over 15 years ago. Seven had a BSc in physics and took an undergraduate course in QM. One teacher had a BSc in mathematics, but has been teaching high school physics for many years. Since graduating, the teachers attended occasionally short teacher courses. The topics they teach include mostly classical physics, and some introduction to 20<sup>th</sup> century physics. The teachers continue to teach and come to study two days in the first two years of the program and one day in the third year. The QM course was the first course in the program.

**The Instructor and the TA:** The instructor of the course is a physics professor at the WIS, with many years of experience in teaching QM to graduate physics students. The TA is a PhD student at the physics department. He holds an MSc degree in theoretical mathematics. The design and teaching of the course was a new experience to both of them.

### Data sources

The following data sources were collected: 1. **Observations** of all classes and recitations by the researchers. 2. **Interviews and informal talks** prior, during and after the course with the

teachers, the instructor and the TA. 3. **A group discussion** with the students, the instructor and the researchers at the end of the semester. 4. **An oral exam** at the end of the course. 5. **A QM survey** administered two months after completing the course. The survey consisted of 10 conceptual questions taken from the QMVI, Cataloglua and Robinett, (2002), and the QMCS, Mckagan, and Weiman (2006). These questionnaires are usually given to both undergraduate and graduate physics, engineering and chemistry students. The questions related to topics such as probability density, particle behavior of waves, discrete energy levels and tunneling. The students were asked to explain each answer. The questions were chosen by the instructor as representing the knowledge he believed the students should have acquired during the course.

## Findings

### What were the goals of the course and its intended content and pedagogy?

The teachers judged initially the course in light of their previous experience with teacher workshops that they attended. These workshops were usually related directly to the topics that they taught in school, while this course seemed initially to be unrelated to their work: *...why do we need this course, how would it help us?"* Moreover, they did not expect a heavy work load *"... we thought that we'll come, hear and that's about it."*

The instructor made a very clear distinction between the goals of this course and those of a graduate QM course for future scientists, *"... I don't think that a teacher should know second quantization...Landau levels. This is interesting and nice, ...but my consideration is what a teacher who won't deal with research needs to know.... I won't go to the same direction as the continuing studies we teach here (at the WIS) to our "regular" students, but would go to directions I assumed could be useful for the teachers in their physical outlook as teachers..."* *"...in regular courses we don't care so much for the understanding of the students, because we believe that the understanding will come later on... here we probably have to work differently... since they won't get another chance to think and to do."*

The following goals of the course came up in the interviews:

1. Deepening and updating the teachers' knowledge. In particular, developing conceptual understanding ("sense of understanding").
2. Providing opportunity to see how scientists think.
3. Promoting teachers' confidence in their physics knowledge.
4. Developing physics thought processes.
5. Contributing to school teaching (e.g. enhancing understanding of the topics of waves and its relationship to geometrical optics).

Following the considerations described above, the QM graduate course, which tends to be very mathematical, has been fitted to this special group. The instructor debated with himself what approach to take: *"...there are two kinds of textbooks: there is the kind that first gives the formal tools...and I felt it was too abstract...at the beginning I wanted to do...I see the abstract structure of the QM, but then I thought: what if this won't "catch"?"*

Following these considerations the following didactical plan emerged:

1. **Focus on developing "sense of understanding"**: The instructor and the TA emphasized conceptual ideas, such as the wave behavior of a particle, the meaning of the uncertainty principle, qualitative description of wave functions in a potential well and the meaning of eigen-functions and of eigen-values.

2. **Historical presentation and logic behind formulas:** "... I did the teaching more or less using an historical approach. I began with de Broglie, I talked about Schrödinger, and so on." "...this way is full of stories, and stories are an interesting thing, if the teachers would like to pass them on (to their students.)
3. **Lower level of mathematics:** The instructors fitted the mathematics to the teachers: What level of mathematics is needed to get the teachers to a "sense of understanding"? How to demonstrate physics thought processes that are heavily based on mathematical reasoning? What level of mathematics is required to promote teachers' confidence in their ability to cope with unfamiliar topics in their teaching (e.g. in guiding project-based learning)?
4. **Assignments:** The teachers were asked to hand in HW assignment, on the average, once in two weeks "*just listening to lectures without "hard work" on applying the knowledge is not effective.*"
5. **The content:** The intended content included atoms, (including periodic table), photons, interaction between atoms-photons and molecules.

### What were the changes in the course that were introduced along the semester?

Overall, the major goals listed above, as well as the basic approach did not change. On the contrary, the instructor and the TA became more and more convinced that the general approach that they have developed has a potential to achieve the goals. The instructor and the TA responded dynamically to the teachers' needs and the researchers' feedback. They changed the structure of the course, and the support given to the teachers, as well as the assignments and the assessments. The following are some of the changes in relation to the intended curriculum described above:

1. **Focus on developing "sense of understanding":** Along the course it became clear what were the challenges that stood in the way of achieving this goal:
  - **"Seeing the big picture":** It seemed along the course, that some of the teachers do not see the big picture although they could understand specific points. This surprised the instructor and he decided to give them some complementary classes at the end of the semester devoted to the big picture. The students thought that this was very helpful: "*...at least for me it was very helpful. I think there is a place to do this 2-3 times during the semester, and this way it helps to keep connected...*" The teachers also stated that they would consider implementing this approach at school.
  - **The assessment:** The instructor was very interested to use the exam as another opportunity for learning and internalizing the central ideas that he tried to convey. Hence, it was very important to him that the students would go over the HW assignments in depth since through these assignments he attempted to highlight the important aspects that he taught. Consequently, he decided to give an oral exam in which the teachers are asked to explain one of the HW assignments and to answer questions relating to this assignment. In their feedback the teachers reported that this form of assessment was very effective in helping them internalize and deepen the various goals mentioned.
2. **Historical presentation:** The implemented approach was similar to the intended one.
3. **Reduced level of mathematics:** Although expecting deficiencies in teachers' mathematical knowledge, the instructor and the TA were not aware of the scope of missing background. The TA said "*...A lot of the time was dedicated to math, and so*

*it was clear that the materials I wanted to teach at the moment was not taught....how much can you cheat a person , if you cover the subject without explaining the mathematics?." Hence, during the course both the instructor and the TA supported the teachers in mathematical aspects.*

4. **Assignments:** The first HW assignments consisted of standard, albeit relatively easy, problems given in graduate courses. The teachers had difficulty to cope with these exercises, they did not know *"how to start solving the problem...."*. In discussing this issue between the instructor and the researchers, a new format of problems was developed. This format explicated the rationale of the solution method, as well as the motivation for giving the particular problem. In addition, the teachers got detailed guidance how to solve the problems. As time went on, the teachers became more proficient mathematically, and as described below, felt more confidence in the next courses. In order to devote more time to practicing the knowledge acquired in the lecture, a change was introduced in the regular way of running recitations at the WIS: *"... the tradition (at the WIS) is that the recitation is an addition, not exactly a new theoretical material, but an expansion of the same subject."* In response to the teachers' feedback, it became very clear that what is needed is helping them with the homework assignment *"The HW assignment is critical. It is their real experience with the subject. I need to model the HW on the board. To give a similar exercise, a close one. Not the same, but in fact, choosing the HW and choosing the exercises in class are assignments with a great correlation."*
5. **The content:** The pace of teaching had been reduced *"...in the regular WIS courses, I must finish the subject, and that's it..."*. Eventually, he skipped the topics of molecules and photons. He added, on the other hand the classical hydrogen atom: *"...I saw this helped them a lot. They saw how a classical atom looks, and how the quantum atom looks. And they could compare one to another..."*
6. **Additional changes**
  - **Lots of support.** In response to the needs of the teachers, 3 PhD physics students served as tutors (1 tutor per 2-3 teachers), each week for 2 hrs. In addition, all the instructors were available for the teachers almost 7/24 via e-mail, phone or at the office.
  - **Work in groups:** The teachers formed work groups *"...very important. The work in groups helps us and unifies us..."*

### What were the outcomes of the course?

The findings suggest that the course contributed to the teachers' knowledge in quantum mechanics; their capability of coping with other mathematics - based graduate courses and to their high-school teaching.

**Teachers' knowledge in quantum mechanics:** Analysis of the 10 conceptual questions gathered out of the QM survey, showed that teachers gained substantial knowledge in quantum mechanics. Comparison of 5 of the questions to results of research done on 5 other groups yielded no significant difference. Moreover, as can be seen in the table, the average of the WIS teachers for all 10 questions (55.5) is the same as the average of the second best group of the 5 groups

	WIS teachers (8)	MOD PHY (33)	Ug QMI Fa00 (14)	Gg QMI (13)	Q CHEM (14)	Ug QMI Sp00 (15)
--	------------------------	-----------------	---------------------	----------------	----------------	---------------------

Total average	55.5	28.5	45.4	55.5	29.7	58.3
---------------	------	------	------	------	------	------

Since the teachers were concerned about the final exam they asked to replace it with an oral exam. In the interviews conducted after the completion of the course, the teachers reported on a "sense of understanding". *The recitation before the exam with the instructor and the TA was very fruitful, and helped us in organizing the material. We saw the whole picture. It contributed to a deeper understanding* and "... an oral exam requires thinking and understanding beyond formulas".

**Ability to study other mathematics-based graduate courses:** Teachers felt that as a result of the quantum mechanics course they are equipped with general tools applicable to other courses as well: "...today in the statistical mechanics course we saw Gaussians, and we saw vector products, and we saw differential equations, and no one even blinked..."

**Teaching high-school physics:** The extensive work, gave teachers confidence in their intellectual ability. Although the subjects taught in the QM course are beyond high school syllabus, the teachers said they are not afraid to relate to topics from the course in their teaching.

*"I think this course made a real contribution. "...I have more answers for the students in the content level..., not that I teach QM, but this is a subject that always comes up. When students approach me on recess I feel much more confident... Many times I add small things in class and tell my students: this is not a thing you will be tested on ..."*

The frustrations associated with the learning, allowed the teachers to feel empathy toward their students: *"The QM course, as opposed to other courses, put us in the position of students. "...After 15 years of teaching, to sit in a student's seat, and to see the other side.... I think that this is the first year in which my beliefs have been changed. I've changed things..."*

## Conclusions

This paper described a possible way of implementing a graduate course for teachers that caters to their needs and takes into account their deficient mathematical background. Based on his experience with the first group of teachers, the instructor decided to precede the teaching of the physics courses with a more extensive mathematics course. This remedy together with the special didactics that was used in the QM course may serve as a model for designing teacher graduate courses that deal effectively with the interplay of mathematics and physics.

## Acknowledgements

Special thanks to S. Levit the instructor of this course for his vision and creative approach; to S. Kotler the devoted and responsive TA, to S. Kapon for her insightful ideas, and to the teachers who made this possible.

## References

Bagno, E., Eylon, B. and Berger, H. (2007). Meeting the challenge of students' understanding formulas in high-school physics - a learning tool. *Physics Education* 43(1), 75-82.

Cataloglua, E., R. and Robinett, W. (2002). Testing the development of student conceptual and visualization understanding in quantum mechanics through the undergraduate career. *Am. J. Phys.* 70(3) March, pp. 238-251.



Clement, J., Lochhead, J. and Monk, G. S. (1981). Translation difficulties in learning mathematics, *Amer. Math. Monthly*, **88**, 286.

Cohen, R., Eylon, B. and Ganiel, U. (1983). Potential difference and current in simple electric circuits: A study of students' concepts. *Am. J. Phys.* 51(5) May, pp. 407-412

Hestenes, D. (2003). Oersted Medal Lecture 2002: Reforming the mathematical language of physics. *Am. J. Phys.* 71(2) February, pp. 104-121.

---

Rebmann, G. and Viennot, L., (1994). Teaching algebraic coding: Stakes, difficulties and suggestions. *Am. J. Phys.* **62**, 723–727.

Mckagan, S. B., and Weiman, C. E. (2006). Exploring student understanding of energy through the quantum mechanics conceptual survey. *AIP Conference Proceedings 818 Feb.*, pp. 65-68.

---

## 2.2 – Analogies : a key to understanding physics

---

Organizer  
Friedrich Hermann

# Analogies: a key to understanding physics

*Friedrich Herrmann (Chairman)*

*Karlsruhe Institute of Technology, Germany, f.herrmann@kit.edu*

*Wu Guobin*

*University of Shanghai for Science and Technology, China, wugb6688@126.com*

*Michael Pohlig*

*Karlsruhe Institute of Technology, Germany, pohlig@kit.edu*

*Hans Fuchs*

*Zürcher Hochschule für Angewandte Wissenschaften, Winterthur, Switzerland,  
hans.fuchs@zhaw.ch*

*Michele D'Anna*

*Liceo cantonale, Locarno, Switzerland, danna@liceolocarno.ch*

*Joel Rosenberg*

*Lawrence Hall of Science, U.C. Berkeley, jrosenberg@berkeley.edu*

## Introduction

*Friedrich Herrmann*

What is an analogy? In physics, by analogy we mean that two or more subfields can be described by means of the same mathematical structure. Any analogy can be resumed in a table that can be seen as a kind of dictionary. The entries of this dictionary are:

physical quantities  
relations between these quantities  
physical phenomena  
words that describe the phenomena  
models  
technical devices  
particles  
fields  
...

When teaching we often use analogies: between the electric and the magnetic field, between a capacitor and a coil, between sound waves and electromagnetic waves, between translational and rotational movements, between Newton's law of gravitation and Coulomb's law. However, there are also dormant analogies. No profit is taken of them. And this profit could be considerable.

We shall present a far-reaching analogy between four sub-fields of science: mechanics, electricity, heat and chemistry. Thus, our dictionary is quadrilingual.

The analogy is based on the fact that each of these scientific domains has its own characteristic extensive or substance-like quantity: momentum (mechanics), electric charge (electricity), entropy (heat) and amount of substance (chemistry) [1,2,3,4,5]. The analogy can be extended to phenomena and processes that are related to the transmission and storage of data [6,7].

The advantages of using this analogy are:

- The physics curriculum is more compact;
- physics is easier to understand;
- the barrier to neighboring disciplines is lowered.

Physics courses based on this analogy have been developed for all levels of education: Elementary School [8] Junior High School [9], Senior High School [10] and University [11,12]. Moreover, there are Web based courses that take advantage of the analogy [13,14]. In recent years, the approach had a substantial impact on official curricula.

Courses have been tested and are now applied in several countries. Just now a test phase is beginning in China.

Wu Guobin from the University of Shanghai for Science and Technology is a key person for introducing the *Karlsruhe Physics Course* in China.

Michael Pohl is a teacher in Karlsruhe. He also gives lectures for future teachers at the Karlsruhe Institute of Technology.

Hans Fuchs is a Professor at the Zurich Institute for Applied Science. He is the Author of several text books.

Michele D'Anna is a teacher and teacher educator at Locarno, Switzerland. He is developing an integrated science course.

Joel Rosenberg is actually working at Lawrence Hall of Science at Berkeley, USA. He is working on a project for energy education.

Friedrich Herrmann is the coordinator of the *Karlsruhe Physics Course* project.

### *Literature:*

- [1] G. Falk, F. Herrmann, G. Bruno Schmid, "Energy forms or energy carriers?," Am. J. Phys. 51, 1074 –1077 (1983).
- [2] G. Bruno Schmid, "An up-to-date approach to physics," Am. J. Phys. 52, 794 – 799 (1984).
- [3] F. Herrmann and G. Bruno Schmid, "Analogy between mechanics and electricity," Eur. J. Phys. 6, 16-21 (1985).
- [4] F. Herrmann, "Eine elementare Einführung in die Physik des Drehimpulses," MNU 39, 274-282 (1986).
- [5] F. Herrmann, "The absorption refrigerator as a thermal transformer," Eur. J. Phys. 30, 331-336 (2009).
- [6] F. Herrmann, P. Schmälzle and G. Bruno Schmid, "Information and its carriers," Phys. Education 20, 206-221 (1985).
- [7] F. Herrmann and G. Bruno Schmid, "An analogy between information and energy," Eur. J. Phys. 7, 174-176 (1986).
- [8] G. Falk and F. Herrmann, *Das Energiebuch* (Hermann Schroedel Verlag, Hannover, 1981).
- [9] F. Herrmann, *Der Karlsruher Physikkurs, Ein Lehrbuch für die Sekundarstufe I* (Aulis, Stark-Verlagsgesellschaft, Freising, 2010) (free English version at: [http://www.physikdidaktik.uni-karlsruhe.de/index\\_en.html](http://www.physikdidaktik.uni-karlsruhe.de/index_en.html))
- [10] F. Herrmann, *Der Karlsruher Physikkurs, Ein Lehrbuch für die Sekundarstufe II* (Aulis, Stark-Verlagsgesellschaft, Freising, 2010)
- [11] G. Job, *Neudarstellung der Wärmelehre* (Akademische Verlagsgesellschaft, Frankfurt am Main, 1972)
- [12] H. Fuchs, *The dynamics of heat* (Springer Verlag, New York, 1996)
- [13] H. Fuchs, *Physics as a system science*, [http://www.zhaw.ch/~fusa/PSS\\_VLE\\_C/index.html](http://www.zhaw.ch/~fusa/PSS_VLE_C/index.html)
- [14] W. Maurer, *Physik der dynamischen Systeme*, <http://www.pegaswiss.ch/>

# Teaching physics with substance-like quantities

Wu Guobin

The point of departure is a certain class of physical quantities: The extensive quantities or, as we like to call them, *substance-like quantities*. Among the substance-like quantities are electric charge, momentum, entropy, amount of substance and energy. What is a substance-like quantity? The value of such a quantity refers to a region of space. This is different from for example temperature, pressure or electric field strength: These quantities refer to a point – not to a region of space. Each extensive quantity  $X$  obeys a balance equation, which, in its integral form, reads:

$$\frac{dX}{dt} = I_X + \Sigma_X$$

The whole equation also refers to a region of space.  $dX/dt$  is the time rate of change of  $X$ .  $I_X$  is the current intensity of  $X$ ; it refers to the surface of the region. Finally,  $\Sigma_X$  is the production rate of  $X$ . The validity of such an equation allows us to imagine  $X$  as a measure of the amount of a substance or fluid. By “imagine” we do not mean, that electric charge, momentum or energy are substances. We mean that we can speak about each of these quantities in the same terms as when speaking about a substance. In other words: We are applying a model when dealing with these quantities, the *substance model*.

According to this model, the change of the value of  $X$  has two causes: First, there may be a flow through the boundary surface of the considered region, and second there may be production or annihilation of  $X$  within the region of space. Thus, the equation establishes a balance of the quantity  $X$ .

For some substance-like quantities, the term  $\Sigma_X$  is always equal to zero. These quantities can change their value within the region only by a flow through the boundary surface. They are called “conserved quantities”.

When using the extensive quantities as a basis for structuring the course, we can take advantage of a far-reaching analogy between the various parts of physics.

We shall construct a table in order to show how the analogy works. First, there are the extensive quantities electric charge  $Q$ , momentum  $p$ , entropy  $S$  and amount of substance  $n$  (first column of the table). To each of these substance-like quantities corresponds an intensive quantity (second column): electric potential  $\varphi$ , velocity  $v$ , absolute temperature  $T$  and chemical potential  $\mu$ . Moreover, to each of the extensive quantities a flow or current exists (third column): the electric current  $I$ , the momentum current or force  $F$ , the entropy current  $I_S$  and the substance current  $I_n$ . Notice, that each line of the table corresponds to a particular subfield of science: electricity, mechanics, thermodynamics and chemistry.

The important thing is, that the table not only contains physical quantities, but also relations between these quantities. Many of the relationships that exist between the quantities of one subfield of science (one line in the table) have a counterpart in another subfield. An example is shown in the fourth column of the Table. These are the balance equations that we had just introduced: The electric

	extensive quantity	intensive quantity	current	balance equation	energy	energy flow
electricity	$Q$	$U$	$I$	$\frac{dQ}{dt} = I$	$E$	$P = U \cdot I$
mechanics	$p$	$v$	$F$	$\frac{dp}{dt} = F$	$E$	$P = v \cdot F$
thermodynamics	$S$	$T$	$I_S$	$\frac{dS}{dt} = I_S + \Sigma_S$	$E$	$P = T \cdot I_S$

charge is a conserved quantity, so, there is no production term. The momentum balance is recognized as Newton's second law. This law can be read in the following way: The momentum of a body changes when a momentum current is flowing into or out of the body. Force turns out to be nothing else than a momentum current. Finally, there is the entropy balance. Here the sigma-term is not zero, since entropy can be produced.

Notice, that the table can be considered a kind of dictionary between four different languages.

There are more entries into the table. There is for instance a generalized capacity. Everybody knows the electric capacity. But there is also a capacity for momentum. It turns out that this is the mass. And there is also an entropy capacity, which is, apart from a factor  $T$ , equal to the well-known heat capacity.

Next, there is a generalized resistance. The electric resistance is well-known, but there is also a mechanical and a thermal resistance. An electric current flows in a resistor from high to low electric potential. We can express this fact by saying: The electric charge goes by itself from high to low electric potential. In the same way we can say that momentum goes by itself from high to low velocity in a process with mechanical friction. Entropy flows by itself from high to low temperature and a chemical reaction runs by itself from high to low chemical potential.

But where in this table is the energy? Do we have to create another line with the energy as a substance-like quantity? The answer is no, since there is no corresponding intensive quantity. Actually, the energy does not define a new field of physics. On the contrary: Energy is important in the whole of physics, in each of the fields defined by these four lines. So, in our table, we do not need a new line for the energy, but a new column – with the energy in every line. In our dictionary metaphor, energy is an “international word”. It is the same in each of the four languages.

Let us now consider one more column with equations. Each of these equations represents a description of an energy transport. It is customary to say that energy is transmitted in one or the other “form”, according to which of the equations describes the transmission. The first equation corresponds to the so-called electric energy. If the pertinent relation is that of the next line, then the energy exchange is called “work”. The next equation describes a transport in the form of heat and the last one corresponds to chemical energy.

We consider a last example that shows the working of the analogy. We have seen, that electric charge flows by itself from high to low electric potential. However, often it happens that one wants the charge to go from low to high potential. This can indeed be realized. We have to “force” the electric charge. We need to “pump” it from low to high. We need an “electricity pump”. The technical name for “electricity pump” is battery or generator. An electricity pump brings electric charge from low to high electric potential.

Momentum goes by itself from high to low velocity. In order to bring it from low to high velocity, we need a “momentum pump”. The technical name is motor.

Entropy goes spontaneously from high to low temperature. To bring it from low to high temperature we need an entropy pump, technically called a heat pump.

When taking this analogy seriously, the extensive quantities of the second column are to be treated as basic quantities. For our teaching we can conclude:

- electric charge from the beginning;
- momentum from the beginning;
- entropy from the beginning.

These are interesting conclusions. Normally electric charge is introduced at the beginning of the teaching of electricity. Momentum, however, is considered only late in the mechanics syllabus, in the context of collision experiments. And entropy, at least in schoolbooks, is not treated at all, and even in University physics it is introduced rather late in the thermodynamics lecture.

The power of our concept is that phenomena, processes, devices, which in the traditional curriculum appear to be completely independent, turn out to be only different realizations of one and the same basic structure.

## Analogy of energy transports

*Michael Pohlig*

The equations  $P = U \cdot I$ ,  $P = v \cdot F$ ,  $P = T \cdot I_S$  and  $P = \mu \cdot I_n$ , (see the table in the previous section) document, that energy never flows alone. There is always another current of a substance-like quantity, like electric charge, momentum, entropy or amount of substance. One more relation of this kind, is  $P = \omega \cdot I_L = \omega \cdot M$ . In this case the substance-like quantity that comes along with the energy is angular momentum. The flow of the angular momentum is usually called torque.

These equations suggest that we can create a vivid and useful picture of an energy transport. We name such pictures or diagrams “energy flow diagrams”.

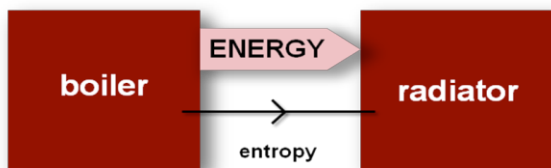


Fig. 1. Energy flow diagram. The energy carrier is entropy.

Fig. 1 shows the energy transport from a boiler to a radiator in a central heating system. We call the boiler the “energy source” and the radiator the “energy receiver”. Together with the energy there is a flow of entropy. Entropy is the “energy carrier”. We say entropy carries energy from the boiler to the radiator.

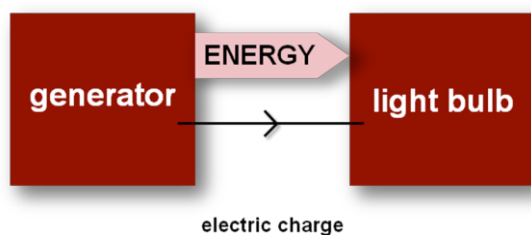


Fig. 2. Energy flow diagram. The energy carrier is electric charge.

In Fig. 2 the energy source is a generator and the energy receiver is a light bulb. Electric charge carries energy from the generator to the light bulb. This diagram is not complete, however. After the energy carrier electricity has “unloaded” its energy within the light bulb it returns to the source. Therefore we draw another arrow for the electric charge that goes back to the generator, Fig.3.

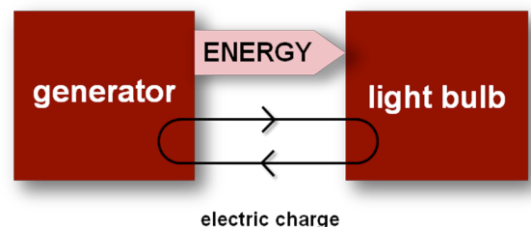


Fig. 3. Energy flow diagram. The energy carrier electric charge flows back to the source.

In Fig. 4 the energy source is a turbine and the energy receiver is a generator. Now the energy

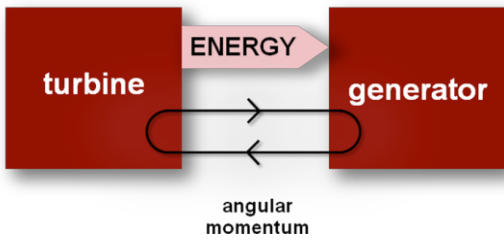


Fig. 4. Energy flow diagram. The energy carrier is angular momentum. The generator is an energy receiver.

carrier is angular momentum. Comparing figures 3 and 4 we see, that the generator acts simultaneously as an energy source and an energy receiver. This observation leads us to introduce yet another symbol, Fig. 5.



Fig. 5. Energy transloader

The generator receives energy with the energy carrier angular momentum and gives it away with the carrier electric charge. Within the generator energy is “unloaded” from angular momentum and “loaded” on the electric charge. That is why we call the generator an energy transloader.

Energy is often transloaded several times in succession. An example is shown in Fig. 6.

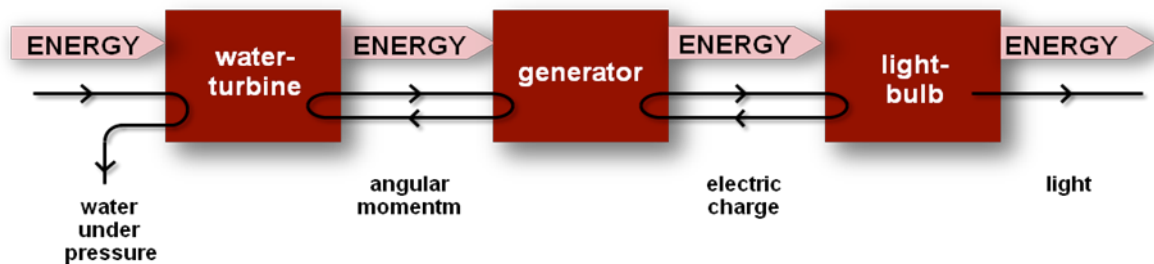


Fig. 6. Several energy transloaders in succession.

If the energy transloaders are connected the energy carrier at the exit of the first one must match the one at the entrance of the second. The rule for chaining energy transloaders is the same as that for playing domino.



# Origin of Analogical Reasoning in Physics

*Hans U. Fuchs*

Analogical reasoning is a form of figurative thought. Its precise meaning is very much subject to what philosophical stance one might take. Traditionally, analogy, like metaphor, is considered more of an embellishment of language than a serious (scientific) form. More recently, however, analogy has been recognized in cognitive science and cognitive linguistics as a fundamental and indispensable form of thought underlying much of human creativity.

Here, a definition of analogy motivated by recent advances in cognitive linguistics and in research into conceptual structures in continuum physics is presented. In this approach, analogy derives from the fact that human figurative thought leads to structuring of different phenomena with the help of the same recurring experiential gestalts, called Force Dynamic Gestalts (FDGs). FDGs are structured on the basis of image schemas (i.e., recurring patterns of experience or experiential gestalts) that are projected metaphorically onto objects of human thought. The basic aspects of FDGs created in this manner are quantity, quality (intensity) and force (or power). By employing FDGs, different phenomena are made similar to the human mind.

This similarity is made use of in analogical reasoning. The best known example of this form of analogy is Sadi Carnot's comparison of heat engines with waterfalls. Here, quantity (of fluid) is projected onto heat whereas level differences (differences of intensity) and power of a fall of fluid become temperature differences and power of heat, respectively.

## Schematic Structure, Metaphor, and Roots of Analogy

Analogies are the result of a creative process. Cognitive science in general, and cognitive linguistics in particular, have taught us that thought is *figurative*: we use recurring experiential gestalts to structure our understanding of the world [1,2,3,4]. When the same structures (commonly *image schemas* [5,6,7]) that result from the embodied nature of our mind are *metaphorically projected* onto different phenomena, the human mind sees these different phenomena as *similar*. Such similarities are exploited in the production of *analogy* [8]. As a consequence, similarity is the result of this creative process, it is not preexisting out there in nature independently of the human mind and used post hoc to express an analogy.

To give an example, if we speak of *anger*, we use a schema called FLUID SUBSTANCE to describe and reason about aspects of this phenomenon. We may say that anger grew in him, that there is a lot of anger present in this group of people, that he passed his anger on to others, etc. At the same time we conceptualize of the intensity of anger: steaming anger, mild anger, etc., which makes use of the SCALE or VERTICALITY schema (the intensity of anger is high or low). The use of these schemas for phenomena that, by themselves, have nothing to do with fluid substances or verticality, is called a metaphoric projection (see Fig. 1).

Since we use the same schemas to conceptualize other phenomena such as pain, justice, light, fire, etc., these phenomena obtain a degree of similarity in the human mind (see Fig. 1) where the similarity is one of conceptual structure. The mapping of this structure from one field to another is called analogy. [8,9]

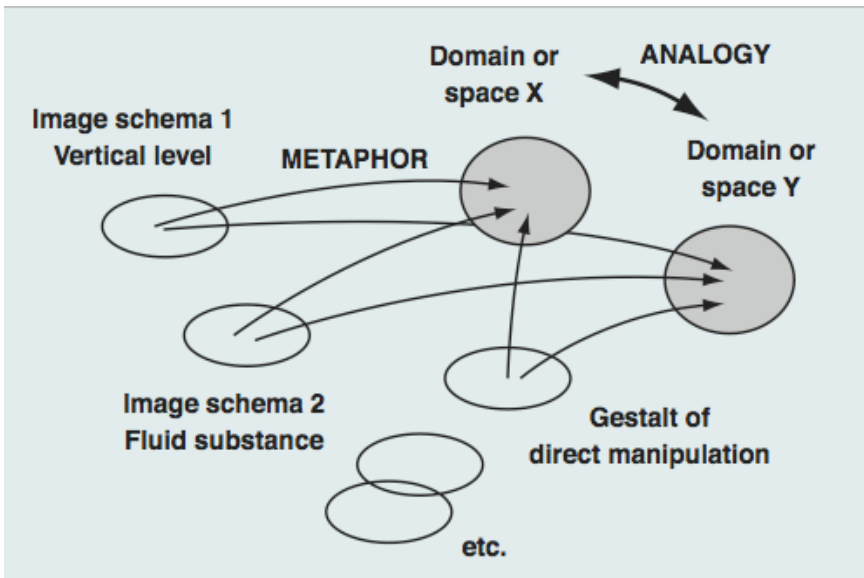


Fig. 1. The creation of similarity as a result of the metaphoric projection of a small number of image schemas upon different phenomena. This apparent structural similarity allows structure mapping—a general form of analogy. [8]

### Force Dynamic Gestalt

One of the most pervasive experiential gestalts created in the perception of complex phenomena (justice, heat, anger, electricity, motion...) is what I call Force Dynamic Gestalt (FDG). [8] We first perceive these phenomena as wholes, then we begin to differentiate them, i.e., we create aspects. This differentiation happens more or less unconsciously; only when we begin to reflect upon our understanding of these phenomena do we become aware of the common aspects of the FDG. Natural language demonstrates that we use three figures to structure the gestalt [10]:

1. Quality or intensity
2. Quantity or size
3. Force or power

There are additional (sub-)structures. Essentially, several or all of the schemas identified by Leonard Talmy [11] in his theory of force dynamics (hindering, causing, letting, balance...) are employed. Furthermore, schemas such as the CONTAINER schema are used to extend the conceptualization of the FLUID SUBSTANCE schema (substances are contained somewhere, and they flow into and out of these containers).

As an example, consider how we speak (and according to cognitive linguistic, how we reason) about the phenomenon of justice. Here are some common expressions:

- *Quality, intensity, level*  
I have always found that mercy bears richer fruits than strict justice. (A. Lincoln)
- *Object, quantity, (fluid) substance*  
Justice denied anywhere diminishes justice everywhere. (Martin Luther King, Jr.)
- *Force or power*  
The healing power of justice.

The FDG which I have identified in the examples presented here can be seen to exist in our stories that make up our culture. As we will see, science is part of this culture.

### *Image Schemas and Other Schematic Structures*

As mentioned before, (image) schemas play a fundamental role in embodied understanding [5,6,7]. The concepts of *quality* (intensity...), *quantity* (object, substance...) and *force* (power) originate in recurring experiences that lead to the formation of *image schemas* and other basic experiential gestalts. For us, the most important are:

- Scale and verticality
- Object, (fluid) substance
- Direct manipulation

There are many more, and their form, meaning and status in theories of the human mind are subject to intense current research [7].

### Application of the Theory of the FDG to Physics

If we consider macroscopic physics in the form of a theory of continuous processes (continuum physics, [12-14]), we can identify the same basic structure of human conceptualization, i.e., the Force Dynamic Gestalt, that appears in the field of human interactions as well [9]. Take the phenomenon of electricity where we speak of a quantity of electricity (charge) being contained in elements and flowing from element to elements. The intensity of electricity, i.e., the difference of the electric potential between different elements is considered the driving force for the flow of charge. Electricity can be used to drive other processes (motion, heat, chemical change), it obviously can effect change. We construct a measure of the power of electricity to conceptualize and quantify this aspect of causation. Naturally, the power of a process is related to the quantity flowing through a given potential difference [15: Chapter 2].

The same structure of reasoning is employed in fluids, chemistry, motion, and heat [15,16-21]. In summary, the concepts of *quality* (intensity...), *quantity* (object, substance...) and *force* (power) are rendered in the form of the concepts of *potential difference*, *fluid substance*, and *energy*:

- Scale and verticality: POTENTIAL
- Object, (fluid) substance: FLUID SUBSTANCE
- Direct manipulation: ENERGY

*Reasoning* based upon these figurative structures leads to a feeling for the *relation* between the three. For an early and important example of this conceptual structure, let us discuss Sadi Carnot's thermodynamics.

### *Sadi Carnot: The Power of Heat*

In the introduction to his book, *Reflexions sur la puissance du feu*, Carnot gave a vivid description of how we can understand thermal processes [22]. Here is a short excerpt:

*Réflexions sur la puissance motrice du feu.* D'après les notions établies jusqu'à présent, on peut comparer avec assez de justesse la puissance motrice de la chaleur à celle d'une chute d'eau [...]. La puissance motrice d'une chute d'eau dépend de sa hauteur et de la quantité du liquide; la puissance motrice de la chaleur dépend aussi de la quantité de calorique employé, et de ce qu'on pourrait nommer, de ce que nous appellerons en effet la hauteur de sa chute, c'est-à-dire de la différence de température des corps entre lesquels se fait l'échange du calorique.

Clearly, this is the FDG of thermal processes, with the aspects of quantity, intensity, and power of heat well differentiated [15: Introduction].

## The Concept of Power

Carnot's thermodynamics can be used to introduce the concept of power in a general manner. Waterfalls takes the role of a physical archetype that can be employed in every field of macroscopic physics. Contained in the image is the formal result that the power of a process (here, the power of a fall of water) equals the product of the flow of the proper fluid substance (here, water) and the difference of levels (here, the difference of the gravitational potential) through which the substance flows (see Fig. 2).

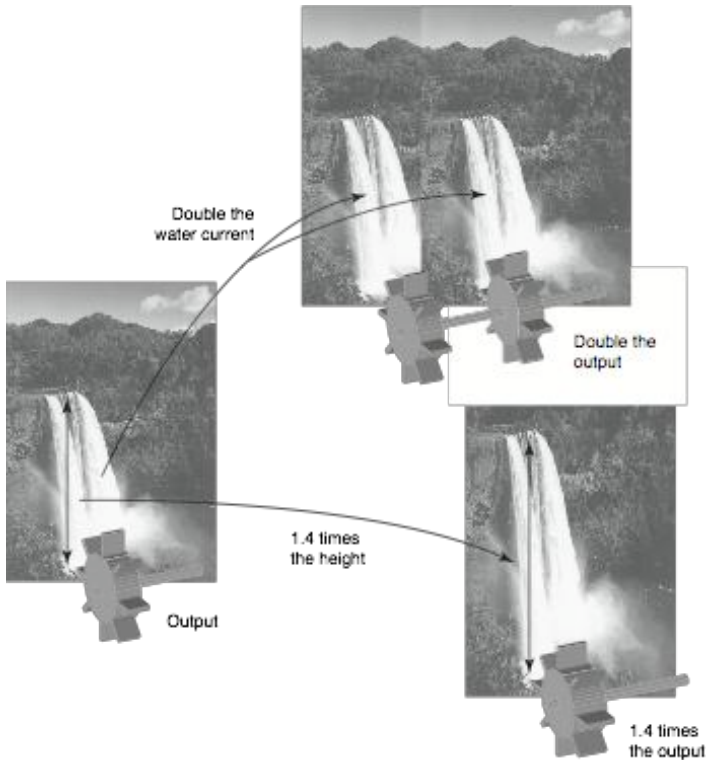


Fig. 2. The power of a fall of water equals the product of the current of water (mass) and the difference of the levels (gravitational potentials) through which the water falls. Figure taken from [23].

## Summary

To summarize the foregoing, the fact that we humans perceive phenomena in the form of the *Force Dynamic Gestalt* allows us to compare different processes in a particular manner. Perception in the form of an FDG leads to the formation of a conceptual structure for a particular range of phenomena. This structure consists of the aspects of the gestalt among which the three most prominent are *intensity*, *quantity*, and *power*. The aspects arise out of a set of tools of thought which is made up of image schemas and other elements of figurative (embodied) understanding. The projection of a schema upon a particular phenomenon is called a metaphor that leads to examples of linguistic metaphorical expressions.

To give a prominent example, we conceptualize of thermal phenomena in terms of the *intensity of heat* (temperature of temperature differences), *quantity of heat* (entropy), and *power of heat*.

Since the same structure is employed to conceptualize vastly different phenomena, these become structurally similar to the mind's eye. As a result we can map the structure of one field upon another. In physics, this leads to a particular form of structure mapping, i.e., analogical reasoning where the structures of theories of phenomena such as fluids, electricity, heat, motion, and chemical

change are directly compared (see Fig. 3). The structure that is mapped is that of the Force Dynamic Gestalt.

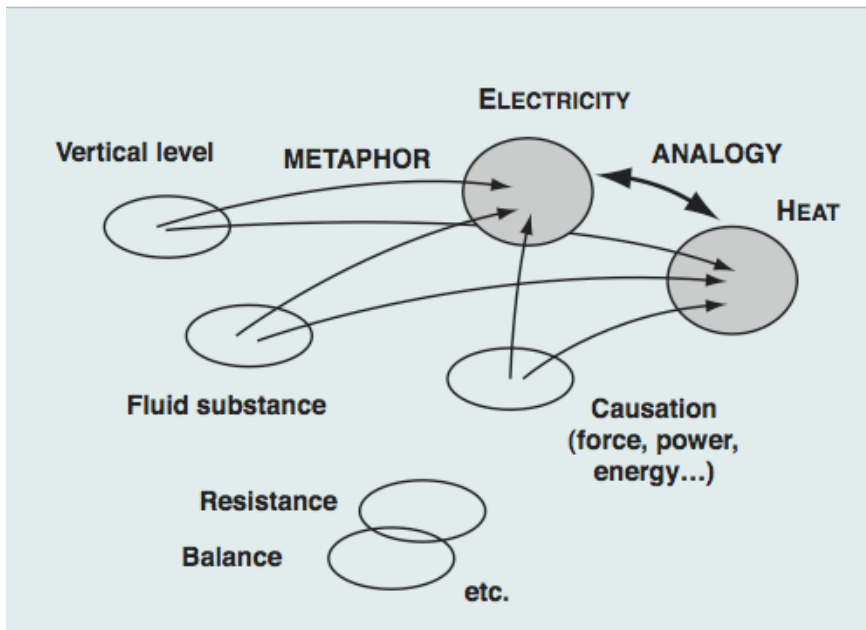


Fig. .: Applying the same FDG with its metaphoric projections to different physical phenomena leads to analogical structures (the metaphoric structure of one subject can be mapped upon another field).

### Literature:

- [1] Arnheim R. (1969): *Visual Thinking*. University of California Press. Berkeley, CA.
- [2] Lakoff G. and Johnson M. (1999): *Philosophy in the Flesh: The Embodied Mind and Its Challenge to Western Thought*. Basic Books, New York, NY.
- [3] Johnson M. (2007): *The Meaning of the Body*. The University of Chicago Press, Chicago.
- [4] Gibbs R. W. (1994): *The Poetics of Mind. Figurative Thought, Language, and Understanding*. Cambridge University Press, Cambridge UK.
- [5] Johnson M. (1987): *The Body in the Mind. The Bodily Basis of Meaning, Imagination, and Reason*. University of Chicago Press, Chicago.
- [6] Lakoff G. (1987): *Women, Fire, and Dangerous Things. What Categories Reveal about the Mind*. University of Chicago Press, Chicago.
- [7] Hampe B. (2005): *From Perception to Meaning. Image Schemas in Cognitive Linguistics*. Mouton de Gruyter, Berlin.
- [8] Fuchs H. U. (2007): From Image Schemas to Dynamical Models in Fluids, Electricity, Heat, and Motion. An Essay on Physics Education Research. Zurich University of Applied Sciences at Winterthur (<https://home.zhaw.ch/~fusa/LITERATURE/Literature.html>).
- [9] Gentner D. (1983): Structure Mapping: A Theoretical Framework for Analogy. *Cognitive Science* 7, 155-170.
- [10] Fuchs H. U. (2006): System Dynamics Modeling in Fluids, Electricity, Heat, and Motion. GIREP Invited Talk, Amsterdam. In E. van den Berg, T. Ellermeijer, O. Slooten: *Modeling in Physics and Physics Education*. Proceedings of the GIREP Conference 2006, August 20-25, Amsterdam. (ISBN 978-90-5776-177-5)
- [11] Talmy L. (2000): *Toward a Cognitive Semantics. Volume I: Concept Structuring Systems*. The MIT Press, Cambridge, Massachusetts.
- [12] Fuchs H. U. (1997): The Continuum Physics Paradigm in physics instruction I. Images and models of continuous change. Zurich University of Applied Sciences at Winterthur.
- [13] Fuchs H. U. (1997): The Continuum Physics Paradigm in physics instruction II. System dynamics modeling of physical processes. Zurich University of Applied Sciences at Winterthur.

- [14] Fuchs H. U. (1998): The Continuum Physics Paradigm in physics instruction III. Using the Second Law. Zurich University of Applied Sciences at Winterthur.
- [15] Fuchs H. U. (2010): *The Dynamics of Heat. A Unified Approach to Thermodynamics and Heat Transfer*. Second Edition, Springer, New York (First Edition: 1996).
- [16] Falk G. and Herrmann F. (1981): *Das Energiebuch*. Hermann Schroedel Verlag, Hannover.
- [17] F. Herrmann and G. Bruno Schmid (1985): Analogy between mechanics and electricity. *Eur. J. Phys.* **6**, 16-21.
- [18] F. Herrmann (2010): *Der Karlsruher Physikkurs*, Ein Lehrbuch für die Sekundarstufe I. Aulis, Stark-Verlagsgesellschaft, Freising (free English version at: [http://www.physikdidaktik.uni-karlsruhe.de/index\\_en.html](http://www.physikdidaktik.uni-karlsruhe.de/index_en.html))
- [19] F. Herrmann (2009): The absorption refrigerator as a thermal transformer, *Eur. J. Phys.* **30**,331-336.
- [20] Job G. and Herrmann F. (2006): Chemical potential – a quantity in search of recognition. *Eur. J. Phys.* **27**, 353-371.
- [21] Job G., Rüffler R. (2010): *Physikalische Chemie*. Vieweg und Teubner Verlag.
- [22] Carnot S. (1824): *Reflexions sur la puissance motrice du feu et sur les machines propres a developper cette puissance*. Bachelier, Paris.
- [23] Borer, Frommenwiler, Fuchs, Knoll, Kopacsy, Maurer, Schuetz, Studer (2010): *Physik – ein systemdynamischer Zugang*, 3. Auflage, h.e.p. verlag, Bern.

# Experiments

*Michele D'Anna and Joel Rosenberg*

Presented here are demonstration experiments that show the far-reaching analogy between different sub-fields of science, as described in previous parts of this symposium. Five sub-fields are covered: 1) hydraulic, 2) mechanical, 3) thermal, 4) electrical, and 5) chemical. For each sub-field, two experiments are described:

A) an intensive potential difference driving the flow of an extensive, substance-like quantity, with the process tending towards equilibrium; and

B) an external intervention pumping the extensive quantity from low to high potential, creating a potential difference that could successively act as a driving force for another process.

Videos of the experiments can be seen online at

[http://www.youtube.com/view\\_play\\_list?p=9B638811E36695C4](http://www.youtube.com/view_play_list?p=9B638811E36695C4).

## 1) Hydraulic (Pressure/height difference drives a fluid flow)

### *Equipment:*

- Two tanks connected by tubing
- Tubing clamp or 2-way stopcock
- Hand-cranked generator and low-voltage (12V or less) fluid pump
- Optional: Flow indicator
- Optional: Blue food coloring

*Hydraulic A)* Two tanks are connected at their bottoms by tubing that is closed by a clamp or valve. With both tanks on the same table, one tank is filled higher than the other, creating a hydrostatic pressure difference between them. When the clamp/valve is opened, the hydrostatic pressure difference between the ends of the tubing causes fluid to flow until the water level is equal in both tanks. A flow indicator can show the flow through the tubing.

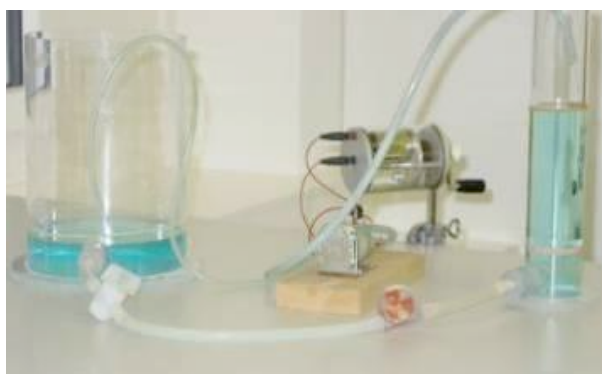


*NOTE:* It is possible that students will not be familiar with hydrostatic pressure. This can either be addressed directly, or it can be ignored and the experiment interpreted as a fluid height difference tending to disappear.

*SUGGESTION:* The equipment can be as simple as two empty plastic bottles. Cut off the bottoms of the bottles, connect tubing to either the caps or bottlenecks, and suspend each bottle on a ring stand.

*Hydraulic B)* Water is pumped from one tank to the other, creating a pressure/height difference. An electric hand-cranked generator connected to a low-voltage fluid pump does the fluid pumping.

*NOTE:* A good question to ask is: "Where does the water that's being pumped into the second tank come from?" It is obviously coming from the first tank, but this question helps set up the analogy, for example with mechanics, which is the next demonstration.





**SUGGESTION:** A purely mechanical fluid pump could be used, or even just a cup to bail water from one tank to the other. For this and all of the following experiments, electrical devices driven by electricity pumps (the hand-cranked generators) were chosen to create an additional constant from one sub-field to the next.

## 2) Mechanical (Velocity difference drives a momentum flow)

### *Equipment:*

- Two cars and 1 meter track
- Putty (for inelastic collision between cars)
- Electric toy train locomotive and 1 meter rail
- Hand-cranked generator
- Wood board (balsa or similar, light but long and stiff)
- Six round metal rods, each 6-8cm long
- Red (or other visible) tape

**Mechanical A)** Two toy cars are set on a horizontal track, one with putty on the end facing the other car. The car without putty is set in motion and when they collide the putty joins them together. The first car slows down while the second speeds up. This can be explained as a momentum flow from the car that is moving to the car initially at rest as the velocity difference disappears.



**NOTE:** The key idea is that both cars end up at the same velocity immediately after impact (but before slowing down due to friction and air resistance).

**Mechanical B)** An electric toy train locomotive is on a train track, and the track is connected to a hand-cranked generator. Turning the generator runs the locomotive motor (a "momentum pump"), which causes momentum to accumulate in the locomotive and create a velocity difference. Question: "Where does the momentum come from?" Students might say the table, the Earth, or nothing at all. At that point, the track is put on a long piece of balsa wood (or similar), which is itself on top of six round metal rods that "insulate" it mechanically from the table. A piece of red tape on both the table and on the balsa show that when the locomotive goes one way, the track/wood goes the other way. In this case it is much clearer that the momentum accumulating in the locomotive comes from the track.



**SUGGESTION:** Not all locomotives will move using a hand-cranked generator. Bring a generator to a hobby shop and try some small trains out to see which work.

## 3) Thermal Systems (Temperature difference drives an entropy flow)

### *Equipment:*

- Hot plate
- Stir plate
- Copper cylinder
- Pyrex dish (must be able to withstand adding a hot metal cylinder)
- Room temperature water-
- Temperature sensors

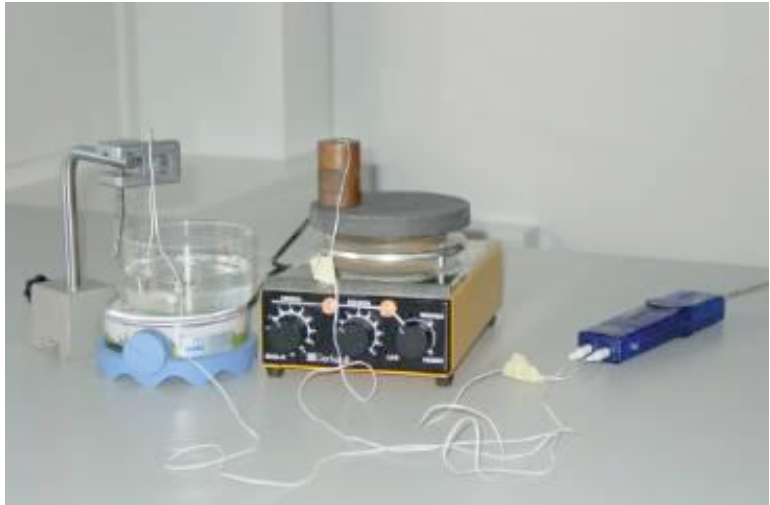


- Tongs
- Peltier device with metal blocks connected to opposite sides
- Hand-cranked generator
- Optional: Thermal conductivity paste (better contact between sensors and Peltier)

*Thermal A)* A metal cylinder is heated on a hot plate, and then moved to a room-temperature water bath in a pyrex dish on a stir plate. Temperature sensors show that the temperature difference disappears as entropy flows from the copper cylinder to the water.

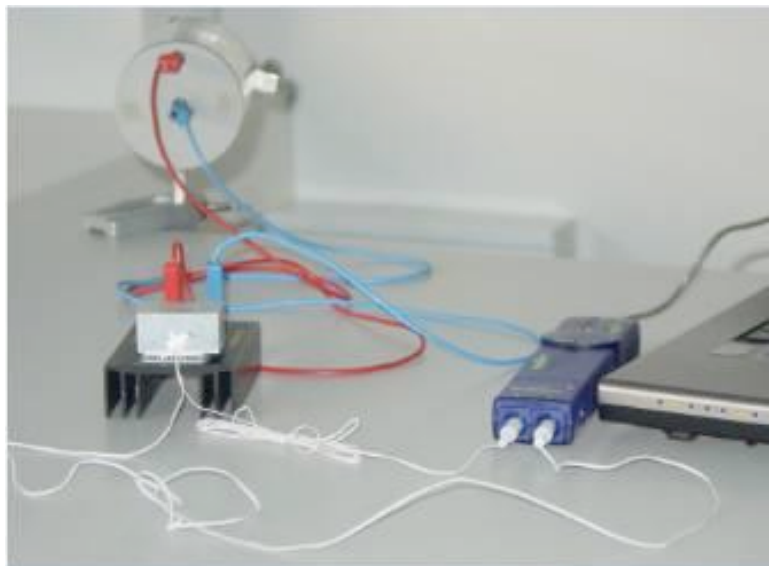
*NOTE:* Like the cars that are still rolling when the velocity difference disappears, the copper cylinder and water are still warm once the temperature difference disappears.

*SUGGESTION:* Instead of temperature sensors, thermometers can be used, or even just a finger -- but don't touch the hot metal cylinder! Also, water can be heated instead of the metal cylinder.



*Thermal B)* A Peltier device is run by a hand-cranked generator. Temperature sensors show a difference being created, with one side getting hotter and the other side getting colder.

*NOTE:* The Peltier device can be looked at as a variation on a refrigerator or air conditioner, though they work by different physical mechanisms. These devices are all types of "entropy pumps" (usually called "heat pumps").



#### 4) Electrical Systems (Electric potential difference drives a charge flow)

*Equipment, including low-cost suggestions:*

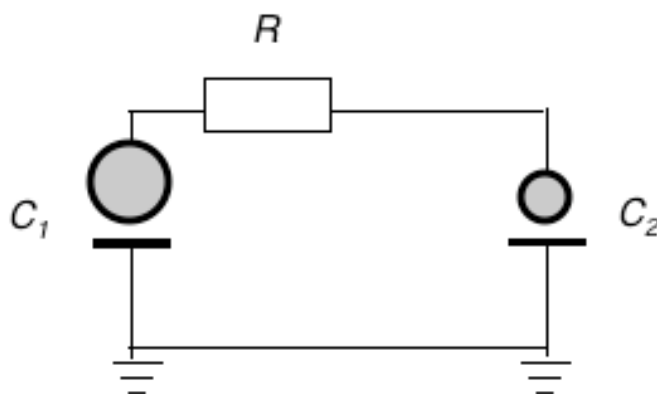
- Static hollow metal spheres on insulating bases
- Two 7.5kV demonstration static voltmeters
- Plastic rod and wool cloth for producing static
- Two +/- 5V centered demonstration voltmeters
- 1.0F 5V capacitor, and 0.22F 5V capacitor
- connecting wires
- 6V 3W light bulb, fan, or other device to run

*Electrical A)* This experiment can be done in two ways.

The first version is more expensive, but easier to understand as an analogy to previous experiments. Two hollow spheres are connected to two (expensive) kilovolt-range voltmeters. One sphere is charged by repeatedly rubbing the rod with the cloth, then running the charged rod along the sphere. When the sphere is charged to around 6kV, it is touched to the uncharged sphere and the electric potential difference between them disappears.

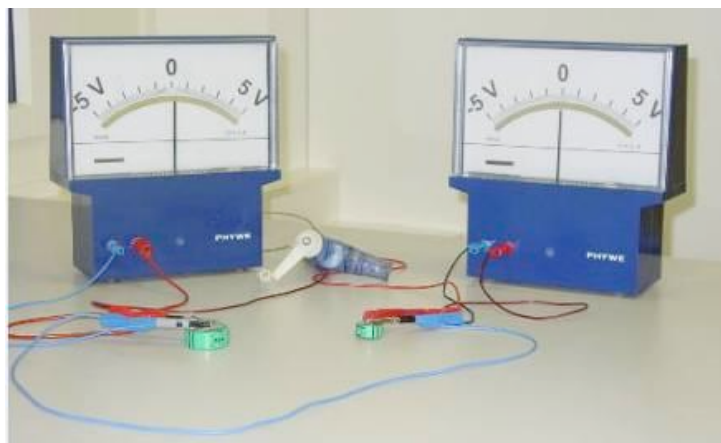


The second version is less expensive and uses two large capacitors, such as 1.0F and 0.22F, and two plus/minus 5V-range voltmeters. The top plate of each capacitor can be considered to act like the spheres in the first version (see schematic diagram). This second version is less obvious, since the plates in the capacitor are hidden. But because the voltage is lower (5V), the voltmeters are much less expensive. Also, since the current is higher, this setup can be used to power a small 6V, 3W light bulb, a fan, or other low-voltage electrical devices.



*Electrical B)* This experiment uses the second version (capacitor setup) from Electrical A. The capacitors are connected to a hand-cranked generator, and to the two 5V-range voltmeters. The "pumps" charge from one capacitor plate to the other, creating an electric potential difference.

**SUGGESTION:** Supercapacitors have high capacitance and are fairly inexpensive.

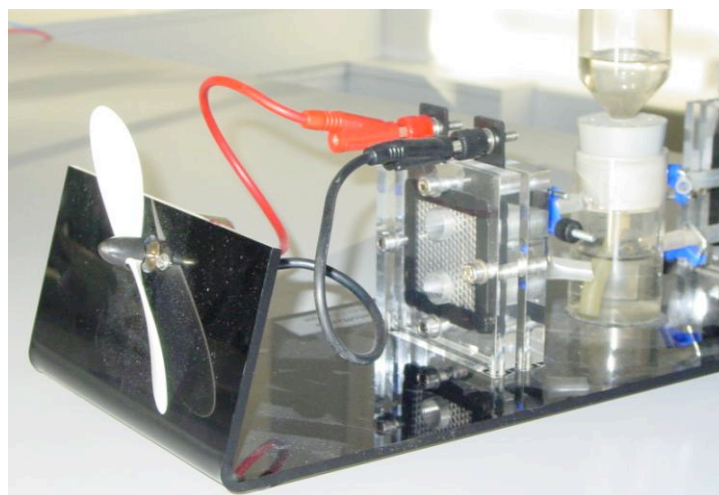


## 5) Chemical Systems (Chemical potential difference drives an amount of substance flow)

*Equipment, including low-cost suggestions:*

- Fuel cell and hydrogen storage
- Electrolysis device
- Dilute sulfuric acid,  $H_2SO_4$  (when diluting water always ADD ACID to water!)
- Hand-cranked generator
- Optional: Voltmeter

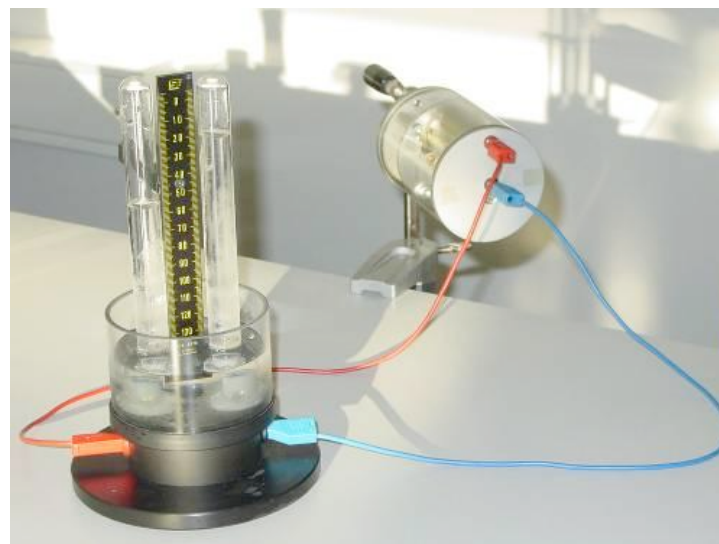
*Chemical A)* A hydrogen fuel cell is used to make a fan motor turn. The chemical potential difference of dihydrogen (generated and stored previous to demo) and dioxygen (from atmosphere) compared with water disappears as they react in the fuel cell to produce water.



*NOTE:* In chemistry education, the reaction between dihydrogen and dioxygen is sometimes said to "happen by itself." This is the equivalent of the chemical potential difference between reactants and products disappearing. The concept of chemical potential as a driving force for an "amount of substance" flow is explained in Job & Herrmann [1].

*SUGGESTION:* Many toy companies sell inexpensive fuel cells.

*Chemical B)* An electrolysis apparatus is filled with water, to which some drops of dilute sulfuric acid are added to ensure electrical conductivity of the solution. The apparatus is powered by a hand-crank generator that splits water into dihydrogen gas and dioxygen gas. The products have a higher chemical potential than water [1]. During generation, bubbles can be seen in each test tube.



*SUGGESTION:* It is possible to create a hydrolysis setup in much less expensive ways than purchasing an electrolysis device.

## Summary comments

The main structural analogy can be seen in all variations of the experiment -- an intensive difference drives an extensive flow towards equilibrium, and a pump can be used to create intensive difference. Of course, there are distinctions between the subfields, and further refinements are required for understanding each subfield on its own. Some examples:

- Momentum and electrical charge can both assume positive and negative values, which is different from a volume of water. But there's also a difference between mechanics and electricity, in that momentum has a directional, vector character [2], while charge is a scalar quantity.
- In thermodynamics, entropy can be produced but never destroyed [3]. This can be pictured in the thermal experiment, where entropy is created by the hot plate, transferred to the metal cylinder, then further transferred in part to the water. Entropy production is always connected with "irreversibility."
- In chemistry, amounts of substance can be produced and destroyed, depending on whether they are reactants or products in a given reaction [4].

In all of the experiments we use a "spy" to observe physical quantities of the system as indications of change. Sometimes we observe an extensive quantity (e.g. with the fluid flow indicator), and

sometimes an intensive quantity (e.g. with the thermometer). An extension idea is to consider which quantities are being observed, and what those quantities indicate.

The demonstration experiments can also be extended to include the generalized resistance and capacitance for each sub-field (see table below). Capacitance, given an input of an extensive quantity in your system, tells you how much the intensive quantity does change. Resistance, given an intensive difference, acting as a driving force, tells you the intensity by which the extensive quantity flows. Resistance is also related to dissipative processes.

In order to link quantitative aspects of the various sub-fields, energy can be included in the descriptions of the experiments as another extensive quantity. It is better to solidify the main structural analogy, and then refine it for each sub-field while also tying everything together with energy.

Science sub-field	Pump	Resistance	Capacitance
Hydraulic	Fluid pump	Fluid resistance	Tank shape
Mechanical	Motor	Mechanical resistance (friction)	Inertial mass
Thermal	Heat pump (Peltier device)	Thermal resistance (insulation)	Heat capacity
Electrical	Battery or generator	Electrical resistance	Electrical capacitance
Chemical	Electrolyzer	Reaction resistance	Buffer capacity

*Literature:*

[1] G. Job and F. Herrmann, "Chemical potential -- a quantity in search of recognition", Eur. J. Phys. 27, 353-371 (2006). [http://www.physikdidaktik.uni-karlsruhe.de/publication/ejp/chem\\_pot\\_ejp.pdf](http://www.physikdidaktik.uni-karlsruhe.de/publication/ejp/chem_pot_ejp.pdf)

[2] F. Herrmann and G. Schmid, "Statics in the momentum current picture", Am. J. Phys. 52, 146-152 (1984). [http://www.physikdidaktik.uni-karlsruhe.de/publication/ajp/Statics\\_momentum\\_currents.pdf](http://www.physikdidaktik.uni-karlsruhe.de/publication/ajp/Statics_momentum_currents.pdf)

[3] G. Falk, "Entropy, a resurrection of caloric, a look at the history of thermodynamics", Eur. J. Phys. 6, 108 (1985). [http://www.physikdidaktik.uni-karlsruhe.de/publication/ejp/Entropy\\_resurrection.pdf](http://www.physikdidaktik.uni-karlsruhe.de/publication/ejp/Entropy_resurrection.pdf)

[4] H. Fuchs, *The Dynamics of Heat, The Dynamics of Heat – A Unified Approach to Thermodynamics and Heat Transfer, 2nd Edition*, Springer, New York, 2010.

[5] G. Job and R. Ruffler, "6. Konsequenzen der Massenwirkung: Säure-Base-Reaktionen", *Physicalische Chemie*, Wiesbaden, Vieweg + Teubner, 2010. <http://job-stiftung.de/pdf/skripte/Stoffdynamik/6.pdf>

## 2.3 – Challenges in primary and secondary science teachers education training

---

Organizer

Marisa Michelini - Physics department – University of Udine – Italy

Rosa Maria Sperandeo Mineo - Department of Physics and related technology- University of Palermo - Italy



## Symposium

### Challenges in Primary and Secondary Science Teachers Education and Training

Coordinators

Marisa Michellini(1) and Rosa Maria Sperandeo-Mineo (2)

(1)*Physics Department- University of Udine, Italy*

(2) *Department of Physics and Related Technology- University of Palermo, Italy*

[marisa.michellini@uniud.it](mailto:marisa.michellini@uniud.it); [sperandeo@difter.unipa.it](mailto:sperandeo@difter.unipa.it)

#### **Introduction**

GIREP Seminar in 2003 gave an important contribution to the problem of *Quality development of teacher education and training*, after the Barcellona Girep Conference in 2000 on *Physics Teacher Education Beyond 2000*. A number of important problems are yet unsolved and a wide research work has been carried out and documented (Abell, 2007). The Working Group3 (WG3) of the EU-Project STEPSTWO (2008) is now facing this topic with the aim of sustaining Physics Teacher Education in universities, notably with regard to the trends in European Teacher Education, in order to reinforce the study of physics subject before university.

This Symposium aims at contributing to analyze and discuss some of the main problems of teacher education and training in physics, both in institutional perspective and in relationship to the curriculum updating and school reforms, by taking into account some main results of WG3 analysis. The professional development and the research perspective are the main aspects here considered for primary as well as secondary teachers.

Teacher education systems are very different in the European Countries: the Bologna process involves a revision of the University missions and the decision related to the link between academic and professional education. The Ministries of Education are discussing this question and it emerges the need of a comparison for some agreements, mainly in the perspective of the school reforms promoted in different countries.

At operative level, the main problems in teacher education are related to strategies and methods to develop Pedagogical Content Knowledge (PCK) (Shulman 1987) both in pre-service and in-service teacher education (Park, 2008). Some related main problems are: the lack of competences in content knowledge (CK); the difficulties of novices in putting in practice pedagogical knowledge (PK) in relationship with CK, the general difficulty to integrate PK and CK for PCK development, planning skills and coherence in teaching/learning paths. Open research questions are: how to stimulate and assess the development of appropriate PCK that includes methodological competences related to experimental exploration, modelling and building formal thinking as well as the ability to promote argumentation in discourse or teaching/learning approaches stimulating meta-reflection.

In the context of the WG3 analysis of the European situation (STEPSTWO, 2008), it has been pointed out that few physics departments and schools of education are actively engaged in the recruitment and professional preparation of physics teachers. Moreover, few institutions demonstrate strong collaboration between physics departments and schools of education and Programs do little to develop the physics-specific pedagogical expertise of teachers in order to achieve a cultural base in science education of teachers of all school levels.

The main problem is how to realize Programs for teacher education supplying educational tools for different situations and contexts aimed at improving teaching competences. Some relevant results have been pointed out by research and Examples of Good Practice. Some of these, mainly connected with pre-service teacher education will be analyzed in this Symposium.

Pre-service education requires to directly face teaching/learning problems of specific subjects. This objective can be achieved by means of teaching activities in which the planning as well as the reflection on didactical proposals are integral parts of the process. Moreover, the direct involvement is considered to be effective only when it is operative and tasks and goals to be reached are clearly defined.

The *Green Paper on teacher education in Europe* (Buchberger, 2000) highlights the crucial role of designing learning situations in which Trainee Teachers (TTs) can find opportunities to develop structures of meaning, knowledge and activities for a didactical reconstruction of the disciplinary contents, integrated with pedagogical competences, methodologies and teaching practices. This aspect will be outlined in the various contributions to the Symposium.

## **1. Challenges in Secondary Science Teachers Education**

### *1.1 Relevant elements of the challenge*

The analysis of the Eurydice reports (1998, 2003) and the first results of WG3 analysis point out many relevant similarities and differences about two main points concerning Pre-Service Secondary Teachers Education. The first involves the structure of the Programs that, although having different characteristics, involve 5/6 years of university education and can be classified into two big categories: a) sequential education, where the pedagogical education follows the disciplinary education; b) parallel education where disciplinary and pedagogical education develop in parallel along the whole period of university instruction. Both the structures present advantages and disadvantages. However, almost all the countries are searching for new Programs and mainly new methods. The second point involves the nature and level of TTs' physics knowledge; in fact, very often, their subject-matter understanding seems not the conceptual understanding they will need to develop in their future pupils.

In these last years, the idea of science education, at all school levels, is strongly changing and consequently a new way of thinking about teacher education is developing. It involves a new framework where the professional preparation of a science teacher is analysed in terms of *professional profile* in the context of jobs for "Human Talent Management" (Tigelaar et al., 2004). Such a profile is frequently described in terms of *competences* and this new word has been also used in most of the new international normative. The usual framework of literature assumes that teacher competences should include:

- Ability to address, master and manage specific knowledge/methods related to the area of interest.
- Capability to integrate different kinds of knowledge/methods in a flexible net.
- Ability to transform such a net of knowledge/methods in a synergic attitude into concrete doing.

This involves that the profile of an effective science teacher is strictly connected with practices. By comparing and contrasting data from partner's of WG3, the following problems have been identified:

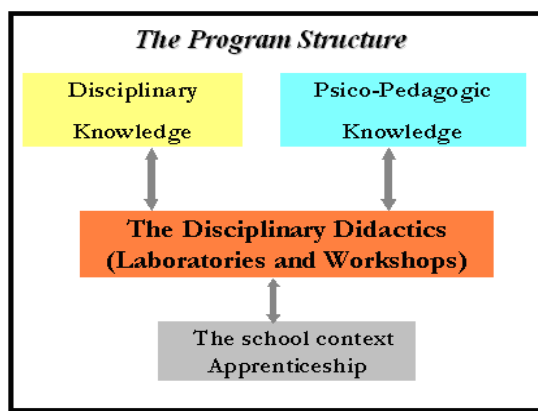
- Lack or insufficient knowledge of the discipline(s) which are supposed to be addressed in the teaching process.
- Lack of reflective practice, especially epistemological reflection about how science is constructed (Knowledge of the Nature of Science).
- The knowledge of the discipline supplied by the university curricula is, in many cases, focused on contents (laws, theories and models), more than on those processes which characterize the discipline and on connections with the real phenomena.
- Compartmentalization of the discipline that fails to make physics more relevant to students, more easily learned and remembered, and more reflective of the actual practice of physics.

- Problems of teaching methods, that are essentially based on a lecture format and content approaches that are often thought as exemplifications of university courses.

Such problems have been analysed by many research papers that tried to identify the main knowledge and abilities grounding the competencies of physics teachers. These identified requirements that would be explicitly addressed in the goals, objectives, readings, and assignments included in pre-service preparation. It becomes relevant to identify Examples of Good Practice supplying evidences and monitoring the growth of the TTs' knowledge, skills and attitudes.

### 1.2 An Example of Good Practice

The interaction between CK and PCK has been the focus of several EU funded Projects. They developed guide lines for Programs and methods supporting the acquisition of the complex set of competences required to physics teachers. Looking at the Italian context, an example of good structure of TT Program is described in Fig. 1.



The structure stands at the center of the training process the laboratory of disciplinary didactics that integrates in a specific context the disciplinary knowledge and the pedagogical knowledge. The analysis of the school contexts, where TTs develop their apprenticeship, participates in the design of appropriate teaching approaches of well defined disciplinary fields, by interconnecting it with the curriculum and with the particular objectives chosen by the school.

Figure 1. Structure of a possible Program for Secondary Physics Teacher Education

Each laboratory/workshop is intended as a prototypal laboratory involving a particular disciplinary content and showing:

- the possible space (of objects, facts, observations, ...) to navigate in order to successfully give meaning to the related conceptual content ;
- the set of landmarks that can guide the individual understanding;
- the conceptual knots pointed out by Physics Education Research (PER);
- the models of common sense knowledge pointed out by PER;
- the critical details made evident in classroom practice.

The laboratory mainly involves TTs in activities, such as

- analysing pupils' reasoning in order to point out mental models connected with their common sense knowledge;
- defining teaching and/or learning goals based on content analysis and diagnosis of students' prior knowledge;
- designing lessons using PER-based instructional strategies;
- designing problematic situations;
- designing experiments and modelling approaches.

The main results of such laboratories focused on disciplinary didactics are published in many papers (see for example: Sperandeo-Mineo et als., 2006; Aiello et als., 2001). General results can be identified in:

- TTs' awareness of deficiencies in their own knowledge of physics and pedagogy;
- appreciation of the need about a clear perception of their students' knowledge;



- deepening of TTs' knowledge of physics and physics pedagogy;
- a systematic research-based approach to the design of specific lessons.

Concerning the used methodology, we should like to outline the role of meta-reflection on their own learning in deepening of knowledge of physics as well as in pointing out the learning knots of the specific topics.

## **2. Challenges in Primary Science Teacher Education**

### *2.1 Some elements of the challenge*

Physics today does not attract young people; some ideas for such a lacking of interest meet a general consensus as, for example, that physics would be more appreciated if pupils start studying it early, or that it is taught superficially by only presenting facts and rules. If our mission is to increase the relevance of scientific knowledge for all citizens, we have to offer a good pre-service education to primary school teachers to this purpose. This is a challenge for all the European Universities and also for the Italian Universities, which have just started their own reform too, so as to conform to the Sorbonne and Bologna agreements.

Relevant elements of such a challenge are:

- The lack of TTs' competencies of in CK.
- The difficulties of novices in putting in practice PK in relationship with an appropriate CK.
- The general difficulty to integrate PK and CK for the PCK development.
- Competence in the construction of coherent teaching/learning paths.

Several EU funded projects have addressed such main problems of teacher education from different viewpoints: hand-on experiment, lab-work, contributions from ICT and ET, informal education,.... in order to gain possible common frameworks based on experimented Examples of Good Practices.

### *2.2 An Example of Good Practice*

An experiment has been carried out in the Degree Course of Primary Teacher Education at the University of Udine, that implemented the development of an *Exploratory Laboratory*, involving experiments and analysis of cognitive paths of both TTs and pupils, before an overall view relating to the specific subject. This work moves from the assumption that pre-service training requires education in the discipline, through the teaching of the discipline itself, and that this objective can be achieved by involving TTs in teaching/learning activities in which the planning as well as the reflection on didactical proposals are an integral part of the process.

Various strategies, based on such hypotheses and characterized by being set in real situation and realizing operative involvement, have been selected. Not completely defined instruments have been offered, since the elaboration and the planning phases are considered a part of the intervention, therefore integrating professional and disciplinary education.

The basic tasks were made by some activities of the "Games, Experiments, Ideas" exhibition (GEIWEB, 1999; Michelini, 2003, 2004) for informal learning. The physics fields explored in the different sections of the exhibition (especially the one on thermal phenomena where on-line sensors are used for real-time acquisition and plotting of evolution of temperature) offered different didactical proposals to be analysed and elaborated in order to plan single experimental activities or differently organized learning paths.

As far as methodology is concerned, TTs were requested to perform their activities carrying out the PEC cycle: prediction of what is going to observe, verification of hypotheses by means of experimentation, comparison of hypotheses with the experimental results and, if needed, formulation of a new hypothesis. No specific instructions were given about the kind of predictions to be made (qualitative as well as quantitative).

The GEI materials have shown to be suitable for the adopted formative intervention, since they favour the personal involvement of TTs, their “putting themselves to the test”, their “learning by experiencing”. Physics education in a context that results funny and very similar to everyday life, confers to the discipline a power of link with common experience which makes the student recognize its cultural value as well as its utility. It gives to physics relevance in improving the personal capacities of observation and the understanding of common phenomena. Finally, the didactical materials of the exhibition are valuable guides for formalization and abstract thinking.

The analysis of results has been centred on the improvement of critical and planning capacities for the construction of professional competences in physics education (Michellini, 2003, 2004), with particular care on the planning of single experimental activities, of explorative experimental chains and of maps and conceptual networks for the definition of paths for the management of formal instruments, either for personal exploration or for didactical proposal definition.

TTs have shown explicit consciousness of the needs of acquiring practical and disciplinary competences, as well as those of assuming methodological and didactical abilities. This stimulated their interest for physics and for its learning and, consequently, teaching to pupils during their apprenticeship. The observation of children and, then, their guiding in the visit to the exhibition supplied TTs with essential didactical elements. On the other hand, the personal involvement in experimental activities introduced them to the development of a scientific and rigorous way of considering real phenomena. In this sense, the activities based on the GEI exhibition have stimulated the acquisition of consciousness of the role played by instruments and methodologies in the learning/teaching process (as in the cases of the construction of appropriate didactical paths).

### **3. Conclusion and some general implications**

In conclusion, we outline some suggestions or keywords for a possible/plausible EU common framework for teacher education. Firstly some main objectives that should be aimed at and secondly some framework features which have to be taken seriously into account.

A broad objective is to have science teachers firmly convinced of the necessity and value of enriching their disciplinary content knowledge and of transforming it into a pedagogical content knowledge suitable for teaching. Another objective is to have science teachers with sound competencies in the infusion of Educational Technologies across the curriculum. A teacher with such competencies uses personally these tools and understands how and when they are appropriate in science education. For example: - integrated use of real-time lab-work and modelling activities to foster/support links between phenomenology and formal thinking; - extensive use and construction of dynamic images in order to exploit visual knowledge so as to facilitate the study of familiar and complex physics phenomena and of their mathematical description. These types of approaches, not related to a specific subject but of transversal nature, require in teachers a deep awareness of the approach rationale and sound skills to guide toward convergence the open class dynamics that is usually triggered.

Amongst the main framework features to cope with, the coherence with the 1999 Bologna declaration is important. The university disciplinary curricula are not yet completely shaped by it, so it is crucial to have a teacher education resonant with “promotion of the necessary EU dimension in higher education”. The results of educational research should be transformed into ingredients of the training Programs, aiming at improving the impact of research on ordinary class practice. The interaction with education authorities (local or central) is crucial to: define priorities, strategies and contents of science education innovation; build, test and propose models/materials; foster and support the take-up of innovations

## References

- Abell S K, Lederman NG (eds), (2007) *Handbook of research on science education*, Lawrence Erlbaum Associates, Mahawa, NY
- Aiello M.L., Sperandeo Mineo R.M. (2001). Educational reconstruction of physics content to be taught and pre-service teacher training: a case study. *International Journal Of Science Education*, vol. 22; p. 1085-1097, ISSN: 0950-0693
- Buchberger A V, (2000). *The Green Paper on teacher education in Europe, EU Community*
- Eurydice (1998) *Thematic bibliography of teacher training: Eurydice Web Site*
- Eurydice (2003) *The teaching profession in Europe: Profile, trends and concerns*. Key topics in education in Europe Volume 3. Brussels: European Commission /EURYDICE
- GEIWEB, (1999)-<[www.uniud.it/cird/Gei](http://www.uniud.it/cird/Gei)>; S Bosio, A Di Pierro, G Meneghin, M Michelini, P Parmeggiani, L Santi, A multimedial proposal for informal education in the scientific field: a contribution to the bridge between everyday life and scientific knowledge, European Multimedia Workshop, Lille, 1998; SciEd21 Book, K Papp, Z Varga, I Csiszar, P Sik eds, Szeged University, Hungary 1999
- Michelini M (2003) *New approach in physics education for primary school teachers: experimenting innovative approach in Udine University*, Inquiries into European Higher Education in Physics, H Ferdinande, E, Vaicke, T Formesyn eds., European Physics Education Network (EUPEN), vol.7, p.180 (ISBN 90-804859-6-9)
- Michelini M., (2004) *Physics in context for elementary teacher training*, in Quality Development in the Teacher Education and training, in *Quality Development in the Teacher Education and Training*, Girep book of selected papers, PT\_F8, Forum, Udine, 2004, p.389-394 [ISBN: 88-8420-225-6]
- Park S Oliver S J, (2008). Revisiting the conceptualization of pedagogical content knowledge (PCK): PCK as a conceptual tool to understand teachers as professionals, *Research in Sci Ed*, 38, 261-284
- Shulman LS, (1987), Knowledge and teaching of the new reform, *Harvard Educational Review*, 57, 1-22
- Serandeo Mineo R.M., Fazio C, Tarantino G. (2006). Pedagogical Content Knowledge Development and Pre-Service Physics Teacher Education: A Case Study. *Research In Science Education*, vol. 36; p. 235-268,
- STEPSTWO (2008) <http://www.stepstwo.eu/>
- Tigelaar, D. E. H., Dolmans, D. H. J. M, Wolfhagen, I. H. A. P., & Van der Vleuten, C. P. M. (2004). The Development and Validation of a Framework for Teaching Competences in Higher Education. *Higher Education*, 48, 253-268.

## **Prospective primary teachers and physics Pedagogical Content Knowledge's**

Marisa Michelini, Alberto Stefanel

Research Unit in Physics Education, Dept. of Chemistry, Physics and Environment,

University of Udine

marisa.michelini@uniud.it, alberto.stefanel@uniud.it

### **Introduction**

The knot of the construction of a culture in which science is an active and integrated part of the cultural baggage of the future citizen, that will call to do socially relevant choices, is a challenge that is played from the early years of schooling (Hubisz 2001; Lederman 2001; Euler 2004; Michelini 2005). From the first years of schools, in fact, mature, in the large majority of children, the separation between scientific knowledge, school learning, everyday knowledge at the origin of many of the difficulties of learning in the scientific field (McDermott, Redish 1999; Duit 2009) and the disaffection towards the scientific study and more in general over and above the actual value of science. It originates in the ways in which science is offered from kindergarten and primary. To affect this situation requires an effective teacher formation and preparation (Buchberger et al. 2000; Michelini 2001, 2003). Main problems in primary teacher training are: the lack in competence in Content Knowledge (CK) on scientific topics and on formalization; difficulties for the novice in putting into practice the Pedagogical Knowledge (PK) in relationship to CK; generalized difficulties in integrating PK and CK within a specific subject to build the related Pedagogical Content Knowledge (PCK) (Shullman 1987; Michelini 2004; Abell 2008, Berry et al 2008).

From the wide spectrum of research results it emerges that primary school teachers education requires a significant integration between the specific subject matter and pedagogical field (Patchen, Cox-Peterson 2008; Samarapungavan 2008; Schwarz 2009). In particular, knowledge of student's conceptual difficulties, competence on strategies effective to face it in classrooms, ownership on teaching methods are necessary (Corni et al 2004; Viennot 2003; Abd-El-Khalick et al 2004).

Relevant open questions remaining on how to test the PCK developed by teachers, how to promote competences related to phenomenological exploration, modeling and building formal thinking, how to construct competences in recognizing student learning paths and processes (Baxter, Ledermann 1999; Park, Oliver 2008).

The analysis of educational proposals and classroom works designed by prospective primary teachers give just some general information about their orientation to the teaching action, to their orientation to the student's learning path, in the use of laboratory, in the way they suggest to propose the contents to the pupils (Corni et al 2004; Samarapungavan et al 2008). Some researches has been oriented to establish detailed criteria for PCK evaluation (Loughran et al. 2008; Mavhunga, Rollnick 2011) or develop standard tools for formative and large-scale evaluation of teaching skills developed by trainees (Schuster et al 2008, 2009; Juttner 2011; Tepner, Witner 2011). These researches focused on the needs to analyze specific competences on CK from one side, and PCK from the other side. The need for collect integrated data on the two competencies it emerge as an open research problem (Schuster et al 2008, 2009, Juttner 2011).

To give a contribution in the evaluation of primary school teachers competencies, and in particular in the integrated analysis on CKs and PCKs related to the same knots, we designed some questionnaires based on PCK methodology, to study how prospective primary teachers during a formative module face CK and PCK with regard the main conceptual knots on: Kinematics and relative motion; Dynamics; Thermal processes, Energy, Equilibrium of fluids.

Here we present the design and the general structure of these questionnaires. A selection of items is also discussed to exemplify the typology of implementation of the items itself, how are presented the different situations analyzed, how sort of answers we obtained in the first experimentation. Final conclusion and remark close this paper.

## Design and structure of the questionnaires

In literature about PCK evaluation and assessment some typologies of questions are more used to evaluate specific PCK competences, as: attitude to a direct instruction versus an inquiry based approach; what type of activity a teacher use to propose a specific content; how a teacher should deal with specific classroom situation for instance created by pupils questions or sentences (Shuster et al 2009; Tepner, Witner 201). The way to present the question is also an important aspect of the design of PCK questions, usually proposing specific situations, a story setting, a classroom case-based or a problems-based situation. Some authors recently, suggesting the needs to explore CK as well PCK competencies, proposing a separate use of CK questionnaires as well as PCK questionnaires (Tepner, Witner 2011; Jüttner 2011). In this way it is not possible to individuate if a PCK problem is rooted in a lack of competence on the related CK, or if a learning problem about CK appear only considering PCK question, but not a CK question.

Our purpose was to design an integrated tool which can be used to explore at the same time CK as well as PCK related to the same specific knots, obtaining punctual information about the correlation between CK and PCK.

A research based path was followed, to design the CK-PCK questionnaires for primary teachers. We individuate subject related knots from literature about the different topics of interest, and in particular the literature about tutorials for basic physics teachers (Arons 1996; Vicentini 1996; Viennot 2002, 2003; McDermott 1996; Whitmann et al. 2004). In Parallel, we collected a set of CK questions and typical student's answers from literature about educational path and students learning (McDermott, Redish 1999; Duit 2009).

The process of selection of items, therefore, started collecting a wide range of questions and a first selection of knots and questions. Then we check the questions selected and the objectives of the Physics Education for primary courses. This give use indications on how integrate or modify some questions to cover effectively the field of interest.

A preliminary version of each item was sub-posed to a cross control by tree different researchers. From this control it emerged the final version of each item. Finally we selected a set of items to include in the final version of the questionnaire. Usually the final version follows 2-3 draft versions. A further revision of the PCK questionnaires was performed after a first experimentation. The questions that gave rise to ambiguous interpretations, not allowing us to explore the specific knot that was focused by the question have changed, replacing or modifying substantially the ones that gave not-significant results.

The questionnaire for each topic concern 5-15 content knots, summarized in the table 1, and it propose 10-15 items subdivided in 2-8 questions. Here we give just some examples, referring to other works for the discussion of individual questionnaires and analysis of results and achievements in relation to different disciplines (Michelini et al. 2011a,b).

<b>Kinematic</b>
The CK knots explored about Kinematic are the following: Need of the system of reference to describe the motion (Malgrande, Saltiel 1986; Viennot 1994); Analyze the velocity using displacement for fixed time intervals (Karplus 1997); Graph of motion (Beichner 1994; Sokoloff, Thornton 1999; McDermott 1999, Sperandeo et al 2002)
<b>Relative Motion &amp; Dynamic</b>
The CK knots concerning relative motion regards: Composition of velocity, relative motion and description of trajectory and velocity in different reference systems (McDermott, Shaffer 2002). Parabolic projectile motion (Hestenes et al. 1992; Beichner 1994); Principle of independence of motion; Description of the motion in different reference systems; Coriolis acceleration in a rotating reference system (Malgrande, Saltiel 1986; Viennot 1994 Sokoloff et al 2004; Wittman et al 2004)
The CK knots related to force are: the effects of a force acting on a body put on a frictionless plane (a disk on the ice); The dynamical analysis of the inclined plane motion; The inertia principle and the inertial forces; The dynamic of a bouncing ball (Hestenes et al. 1992; McDermott 1996;

Wittman et al 2004; Sokoloff et al. 2004)
<b>Fluids</b>
The CK knots explored concerning statics of fluids, regards: the role of density in the distribution of different liquids in a tube; the physical processes at the base of siphon functioning; the buoyancy and the hydrostatic force; the buoyancy and the role of relative density; the atmospheric pressure; the communicating vessels; the emission of a liquid from a container; the nature of the hydrostatic pressure and the Pascal principle; the compressibility of air (Viennot 2002; Heron et al. 2003, 2010).
<b>Thermal phenomena</b>
The knots explored in the case of thermal phenomena: The thermal dilatation coefficient ; The distribution of liquids in a tube; The volumic dilatation; Thermal equilibrium of mixed mass of water initially at different temperatures; Thermal equilibrium of interacting mass of water initially at different temperatures; Phase transitions, Role of the mass in the heating (Tiberghien 1986; Sciarretta et al. 1990).
<b>Energy</b>
The knots explored in the case of energy are: Transformation of Kinetic energy in Internal energy; Conservation of energy , Energetic analysis of process (bouncing ball); Combined Energy transformations (wind mill); Transformation of Kinetic energy-Gravitational Potential energy ; Transformation of Kinetic energy-Elastic potential energy (Driver, Warrington 1986, McDermott 1996; Millar 2005; Heron et al 2008)

**Table 1.** Conceptual knots and contexts explored in the CK-PCK questionnaire for the different topics.

### **The structure of the single item and of the questionnaires**

In the majority of cases (from 50% to 70%), each item is divided in two parts: The first (CK part) explores how a specific subject knot is analyzed by the prospective teachers; a second part (PCK part) explores how typical students answers on a specific question are discussed by them. From 30% to 50% of the items of each questionnaire regard only CK and usually concern that conceptual knots that we know from literature to be particularly problematic for novices.

Each item concerns a specific content knot and the related different learning problems of students. It present:

- A) the problematic situation, usually illustrated with a figure as a map, a graph or a diagram (as in the questions on kinematic reported and more extensively discussed in other work of the present book – Micheline et al. 2011a), a cartoon suggesting the situation (fig. 1), a picture representing a real situation or a photo of a real situation (fig. 2), a schematic representation of the situation (fig.3), some figures reproducing typical students pictures (fig. 4).
- B) then just in the PCK items the typical students answers, as emerged in literature (McDermott, Redish 1999; Duit 2009),
- C) one or two questions that poses to the prospective teachers the subject related knot,
- D) finally, for the PCK items, usually two questions: the first concerning the analysis of the students answers and related learning knots, the second requesting how they can propose in classroom each of knots identified in the answers of the previous questions. In the next paragraph we exemplify some typical items of our questionnaire.

The students answers are often reported from literature, but in some cases, some simulated answers of students was constructed when the real answers including at the same time more than one learning knot, or are too long and do not show clearly the knot faced by the items.

The entire questionnaire provides a picture of the competencies acquired by teachers in the first training on the conceptual knots for the different subjects and the more important aspects remaining open. The PCK questions, which also included a reflection on the main learning problems of children and how to deal with in class, provide also an output on the didactic competencies, in particular about:

- the recognition of the students learning knots

- the identifications on what kind of aspect can be face with pupils to address each specific knots
- the methodology and the strategy they suggest to adopt, in particular if they adopt a direct didactic centered on teacher explanation, or they involve pupils in an open discovery learning environment, propose to pupils some simple experiments and observation, involve actively them in the exploration
- the activity they just suggest, or delineate in an operative way, or plan as effective proposal of intervention in the classroom to face each knot with pupils, focalize on the knot to be faced or the proposal is too generic.

The PCK questionnaires also provide useful feedback of the impact of university training modules that we designed, and indications on how to change them to improve the training proposal where it was less effective.

### Examples of items.

In the present paragraph we exemplify the different typology of items proposed in the PCK questionnaires in particular for what concern the modality of the presentation of the situations and of the specific questions posed, giving also some general results about each items, when proposed to two groups of 234 university students (prospective primary teachers) in the academic years 2008/09 and 2009/10. Here, we propose items concerning the different subjects explored, giving a scenarios also about contents explored, referring for other paper for more deep discussion (Michelini 2011a, b).

#### *Example 1. Relative motion and reference frame.*

The item illustrates the situation with a cartoon in which Donald Duck is chasing, with a club in hand, Fethry Duck. It also specifies that "Duck Fethry runs with a speed of 7 m / s. Donald Duck is moving at a speed of 5 m / s.

In the CK part of the item, you are asked to indicate reasons for each answer: 1) how quickly Donald Duck sees Duck Fethry, 2) how quickly Duck Fethry sees who pursues, 3) How are these two speeds up with each other, 4) if to answer you must specify one or more reference frame and 5) such as.

The PCK part require to discuss the following answers given by three students to question 3: "S1: The two speeds are equal, to ask how quickly Duck Fethry flees from Donald Duck is like asking how Donald Duck quickly Duck Fethry lags behind with respect to Donald Duck. S2: The two velocity has the same magnitude but opposite sign, because the two velocity vectors are oriented in opposite directions. S3: I cannot speak only about the speeds. I need also to talk about how I defined the reference frame of Duck Fethry and Donald Duck one. For example, if Duck Fethry is running back, escaping from Donald Duck, the two speeds will have the same sign.

The CK questions bring into play the recognition and explanation, which three reference frames are required: the first is that the road, to refer the seeds indicated Donald Duck and Duck Fethry, the second is Donald Duck Don solidarity and the third is in solidarity with Fethry Duck. To answer in the sign of the speed also requires the elaboration of a positive direction with respect to which the two characters move in each of the references indicated.

The assumption of implicit reference frames has been the way in which almost all prospective of the sample (90%) answered to the three questions in this item. They have also focused on only one (48%) or two (27%) reference frames for what concerns the question four. Finally the 60% of answering prospective teachers they have mainly (402%) focused on the correctness of student



Figure 1. The situation related to relative motion is presented with a cartoon.

answers, looking at the content aspects involved, rather than discuss the knots underlying the students answers, as the remaining 18% done.

### Example 2. Coriolis acceleration.

The third example concerns the relative motion questionnaire and precisely the Coriolis acceleration in a rotating system. It concerns the CK part as well the PCK part, proposing the question with a photo of a real situation (a photo from the video: “The Coriolis force”, at [http://www.youtube.com/watch?v=\\_36MiCUS1ro](http://www.youtube.com/watch?v=_36MiCUS1ro))

Alberto, Giacomo, Rossella e Stefano are on a carousel. The carousel rotates clockwise. Stefano launch a ball toward the center of the carousel. The CK part is the open ended question: "Who reaches the ball? Explain".

The PCK part presents the answers to the question of the students:

Rossana: "The ball moves in rectilinear motion, then the ball goes straight to Alberto"

Giacomo: "As the ball moves, the carousel rotates and then the ball will come to Rossana"

Alberto: "It depends on the speed with which Stefano throws the ball. In any case, is not straight at me, but to his right. "

This item brings into play the identification of the reference frame in motion, of the role that plays the Coriolis acceleration in the phenomenon observed and hence the direction in which the ball is deflected.

It offers an important context, because a large majority of the everyday dynamical processes observed in relative motion phenomena concern rotating systems and are due to the Coriolis acceleration, rather than the centrifugal acceleration, as it was mistakenly led to believe.

In the answers to the CK part, the 64% of the sample indicated that the ball follow a curved trajectory because of the Coriolis acceleration, divided equally among those who say that the ball comes to Giacomo, and who to Stefano. In this large group 22% give more explanation, making reference to the speed drive of the rotating carousel or constructed the trajectory in the rotating frame with a step by step construction. Other 12 % answered that the ball will arrive to Alberto, because Rossana launches the ball in this direction, while 5% sentences that the problem is undetermined because the answers is depending from the speed of the carousel as well as the velocity of the ball. As regards the PCK part, the 67% of the answering students analyzed each student prevision or in terms of content correctness or simply in term of their own accord with the opinion of students. A percentage less than 5% individuate almost a knot in the sentences.



Fig. 2. The carousel turns in a anti-clockwise direction while Stefano launch the ball the direction of Alberto. To who will arrive the ball? (Picture from the video “The Coriolis force”, at [http://www.youtube.com/watch?v=\\_36MiCUS1ro](http://www.youtube.com/watch?v=_36MiCUS1ro))

### Example 3. Water and oil in the U-tube and the role of density.

The item suggests a situation where: "Water and oil are arranged in a U-tube as shown", usually given in textbooks as an example or exercise on the physics of fluids (see e.g. Halliday et al. 1981). The situation is illustrated with a picture of the section of the U-tube and two quantities of water and oil, represented with appropriate color and eight in the two branches. The item proposes two parts. In the first one, two CK type question are posed: "1) Why is the branch containing oil higher than the one containing water? 2) Determine the density of the oil [Use the following data: water  $\rho = 1.0 \cdot 10^3 \text{ kg m}^{-3}$ ,  $Z_1 = 11.2 \text{ cm}$ ,  $Z_2 = 12.1 \text{ cm}$ ].



In the second part, a problem solving situation suggested by a female student is presented, including CK and PCK sections: "A female student use a very long U tube so she can put a big amount of oil (about 8 liter). Her objective is to move the water column just in the left arm of the U tube.

Her schoolmates say: Paolo: it is sufficient add a quantity of oil equal to the volume of the elbow of the U; Sara: you don't will be successful in any case; Luca: it is sufficient to put a quantity of oil equal to two times the weight of the water".

The requests are: "3) What kind of answer give you to the problem? 4) How you comment the answer of Paolo, Sara e Luca?

In a first formulation, the item was proposed illustrating the U-tube and requiring only a draw as the two quantities of the liquids would be willing. The difficulty to face a so open question, evidenced in a first implementation, suggested to formulate this final version.

The two parts of the item are closely related on a subject related point of view and in particular the questions 1) and 3) need to recognize the different density of the liquid from the situation shown in the figure and that actually takes place when water and oil are putted in a U-tube The question 2) if one side is proposed as a simple exercise, the other seeks specifically to enable this recognition. From the cognitive point of view the experiment proposed by the child brings into play the idea that to determine the disposition of liquids is their weight, rather than their relative density, as underlying the suggestions of Paulo and Luca. The observation of Sara, who correctly predicts the negative outcome of the experiment, leaving open the exploitation of the explanation, it stimulates the comments to provide it, although not explicitly requesting it.

Only 12% dealt with the simple exercise proposed again underlining the great difficulty coping with even simple exercises that require the use of mathematical formalism. 28% identified the role of density in the two situations discussed and useful, but only 10% knew how to use this concept to answer the questions. 60% answered the questions proposed focusing on the concept of weight. The comments to suggestions of children, expressed mainly on the disciplinary aspects of teaching are rather more than those related to disciplinary skills highlighted in the previous answers and not go beyond general indications to suggest unspecified experiments

#### **Example 4. The buoyancy of solids in fluids, pressure in a fluid and the Pascal principle.**

The item, redesigned by similar open ended question proposed to investigate the students' ideas on the waterline (Heron et al. 2003), proposes the following situation: "Five compact objects, the same shape and volume but of increasing mass ( $m_1 < m_2 < m_3 < m_4 < m_5$ ), are left in a tank containing water. The object of mass  $m_5$  sinks, while the object of mass  $m_2$  floating on the water (the upper surface of the object is located at the free surface of water). Two students in a class have the following drawings to illustrate how you arrange the objects in the water ". The item requires to "Comment on each of the two illustrations, pointing which learning knots and how they could intervene in the classroom to overcome them". The item is of type PCK, since the two pictures are typical drawings made by students in response to the question, but in an indirect way it explores CK also.

The answer to this question requires the recognition that an object thrown into the water or sink, if its average density is greater than water, or floats if its density is less than that of water.

It is expected therefore that the objects 3-4-5 sink, or sink up to 4 and 5 and the object 3 can float in any position, in equilibrium with the water, as the authors have suggested the same question (Loverude et al. 2003). It can also be handled if it is not explicitly recognized the role of the density

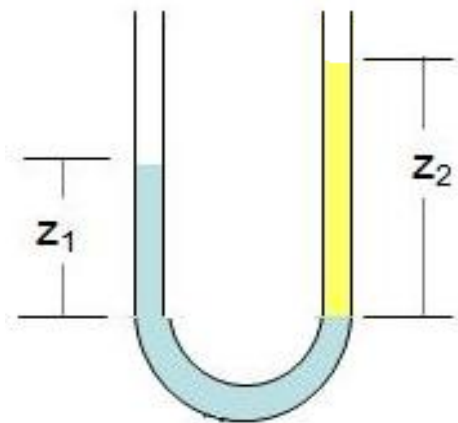


Figure 3 The figure shows how a certain amounts of water and oil arrange themselves in a U-tube.

of water, taking into account the fact that when a body is thrown into water or sinks or floats and then taking into account the fact that all the cubes "heavier" of the cube 3 must necessarily sink. 68% of the sample chose the picture B), providing an explanation, in little more than half the cases, based on the concept of density in (20%), the concept of weight (15%). 19% chooses the drawing B) by adding that the cubes arrange themselves at different depths in order of increasing weight.



Fig.4 The pictures illustrate that typical patterns of students, about the results of immersion of objects of equal shape and volume but different mass.

### Example 5. The constancy of temperature at a phase transition.

About thermal phenomena, here we present a classroom context, where three children, Marco, Stefano, Rossana, face the everyday life situation: "When the water boils in a pot, what happens to its temperature?"

Marco says: "Continues to rise, because the water continues to be heated"; Stefano explains: Continue to rise, but very little (about 1-2 ° C); Rossana says: It remains constant".

Related to these assertions, the requests are: to discuss each answer, to indicate the related knots and how it is possible to modify and/or support the learning. To address this question it is necessary to take into account the constancy of the temperature at the phase transition. The assertion of the children bring into the field typical beliefs, that the temperature rise during the phase transition, or that come up, but in a different way with respect to the heating phase.

The question was answered by the 70% of the sample that has framed the situation as a case in which the temperature does not change. The predictions of the three students were mainly analyzed in terms of discipline, highlighting the correctness or not, according to the CK question.

### Conclusions

The need to train the prospective primary school teachers, both as regards content and disciplinary competences (CK), as well as those related to pedagogical content knowledge (PCK), requires specific training activities. The evaluation of competences developed in training requires tools specifically designed to assess both CK on each specific knot, for the PCK and their relationship. Therefore, PCK-questionnaires were designed, based on different physical content (kinematics and relative motions, dynamics, statics of fluids, energy and thermal phenomena). These questionnaires were implemented in the context of a University module for the formation and preparation of prospective primary school teachers on the physics education.

The questionnaires were constructed with a number of items, each of them focuses on a conceptual knot of the main disciplinary subject concerning the University courses. The design of the questionnaires started from a re-analysis of the typical questions developed from the literature, investigating the learning processes of students, about the different topics. These questions have been reformulated in general by providing some type CK, which is to explore the conceptual knot from the point of view of discipline, and a second PCK part which require the analysis and discussion of the typical student responses.

The formulation of each question followed a long process of discussion among researchers to get to the final shared formulations and in some cases to a redesign after a first implementation, especially in the cases where the questions had given rise to ambiguous interpretations, or where the results

had few significant. Particular attention has been dedicated in the design of each question, to how present the situation proposed with appropriate maps, graphs, charts on which to build graphics, or sketch the responses. The integration each item of a part on CK and a related part on PCK give the opportunity to collect information about how CKs and PCK affect each other. The results of the implementation of the questionnaires showed the effectiveness of the instruments made, both in providing information on the outcome of training, and also a feedback to the prospective teachers on the issues unresolved, or on their main training needs. The proposed questions have been shown to be effective in identifying specific learning knots conceptual of future teachers, in particular giving useful indications on how to change the formation. They have also made it possible to show that lack in the PCK, are not only related to problem about specific CK, but also to a lack of focus in the educational activities of defined learning objectives.

## **Bibliography**

- Abd-El-Khalick F et al. (2004) Inquiry in science education. *Science Education*, 88(3), 397-419.
- Abell, S. K. (2008). Twenty years later: Does pedagogical content knowledge remain a useful idea? *International Journal of Science Education*, 30(10), 1405-1416.
- Arons A. B. (1996) *Teaching Introductory Physics*, Wiley, NY.
- Baxter J. A. & Lederman N. G. (1999). Assessment and measurement of pedagogical content knowledge. In: J. Gess-Newsome & N. Lederman (Eds.), *Examining PCK*, 147-161.
- Beichner, R.: Testing student understanding of kinematics graphs. *A.J.P.* 62, pp.750-762, 1994
- Berry A, Loughran J., van Driel J.H. (2008) Revisiting the Roots of Pedagogical Content Knowledge, *International Journal of Science Education*, 30 (10) pp. 1271–1279.
- Buchberger F., Campos B.P., Kallós D., Stephenson J. (eds) (2000) *Green Paper on Teacher Education in Europe*, TNTEE Publications, Umea, Sweden.
- Corni F., Micheli M., Stefanel A. (2004) Strategies in formative modules for phys. educ. of primary teachers, in *Quality Development in TE&T*, M. Micheli (ed.), Forum: Udine, 382-386.
- Driver R and Warrington L. (1985) Students' use the principle of energy cons., *PE* 20, 171-175.
- Duit, R. (2009) Bibliography „STCSE“, <http://www.ipn.uni-kiel.de/aktuell/stcse/stcse.html>
- Euler, M. (2004) The role of experiments in the teaching and learning of physics. In *Research on Physics Education*, E. F. Redish & M. Vicentini eds., IOS, Amsterdam, pp.175-221.
- Halliday D., Resnick R. (1981) *Fundamental of Physics*, vol. 1. Chap. 16 Fluids, Wiley, NY.
- Hestenes D., Wells M., and Swackhamer G. (1992). *FCI*, *The Phys. Teac.* 30, 141-151.
- Hubisz, J.L. (2001) Physics? Yes, but when?, *AAPT Announcer* 31(4): 8.
- Jüttner M. (2011) How to Measure PCK Science Teachers, Symposium in Esera Conference 2011, at [http://www.esera2011.fr/images/stories/ESERA\\_2011\\_Detailed\\_Prog\\_SOP\\_Symp.pdf](http://www.esera2011.fr/images/stories/ESERA_2011_Detailed_Prog_SOP_Symp.pdf)
- Karplus, R., (1997), Science teaching and the development of reasoning, *JRST*, 14(2): 169-175.
- Lederman, L. (2001) *Physics First*, APS Forum on Education Newsletter, Spring 2001; online at: [/units/fed/spring2001/index.cfm](http://units/fed/spring2001/index.cfm).
- Loverude M. E., Kautz C. H., and Heron P. L. (2003) Helping students develop an understanding of Archimedes' principle. I. Research on student understanding, *A. J. P.* 71 (11), pp. 1178-1187.
- Loughran J., Mulhall P. and Berry A. (2008) Exploring Pedagogical Content Knowledge in Science Teacher Education, *International Journal of Science Education*, 30 (10) pp. 1301–1320.
- Mavhunga E., Rollnick M. (2011) Development and pre-piloting a tool for measuring of topic specific PCK in chemical equilibrium, Panel talk Esera Conf.2011, at [http://www.esera2011.fr/images/stories/ESERA\\_2011\\_Detailed\\_Prog\\_SOP\\_Symp.pdf](http://www.esera2011.fr/images/stories/ESERA_2011_Detailed_Prog_SOP_Symp.pdf)
- McDermott L. C. (1996) *Physics by Inquiry*, Wiley, NY.
- McDermott L.C. (1999) Students' conceptions and problem solving in mechanics, in A. Tiberghien, et al. (eds.), *Connecting Research in Phys. Educ. with Teacher Education*, An I.C.P.E. Book
- McDermott L.C., Shaffer P.S. (2002) *Tutorials in Introductory Phys.*, Prentice, Upper Sadle River.
- McDermott, L. and Redish, E.F. (1999) Resource Letter, 'PER-1: *A.J.P.* 67 (9): 755–767.

- Michelini, M. (2001) Supporting scientific knowledge by structures and curricula which integrate research into teaching, in *PhyTEB 2000*, R. Pinto, S. Surinach eds., Elsevier, Paris, p.77.
- Michelini M. (2003) New approach in physics education for primary school teachers, in *Inquiries into European Higher Education in Physics*, H. Ferdinande et al. EUPEN, vol.7, p.180.
- Michelini M. ed. (2004) *Quality Development in Teacher Education and Training*, Forum, Udine.
- Michelini, M. (2005) The learning challenge: A bridge between everyday experience & scientific know. Planinsic G. ed., *Informal learning and public understanding of physics*, Ljubljana, 18-38.
- Michelini M. Santi L., Stefanel A., Vercellati S. (2011a) Community of prospective primary teachers facing the relative motion and PCK analysis, in *Giper Reims sel. paper.*, in this book.
- Michelini M. Santi L., Stefanel A. (2011b) PCK approach for prospective primary teachers on energy, *Girep Congres, Jyväskylä, Finland* 1.-5. August 2011.
- Millar, R. (2005). *Teaching about energy*. Dep. of Educ. Studies, Res. Paper 2005/11. York.Univ..
- Park S. and Oliver J.S. (2008) Revisiting the Conceptualisation of Pedagogical Content Knowledge (PCK): PCK as a Conceptual Tool to Understand Teachers as Professionals, *38 (3)*, 261-284.
- Patchen T. and Cox-Petersen A. (2008) Constructing Cultural Relevance in Science: A Case Study of Two Elementary Teachers, *Science Education*, 92(6), 994-1014.
- Samarapungavan A, Mantzicopoulos P, Patrick H (2008) Learning Science Through Inquiry in Kindergarten, *Science Education*, 868-909.
- Shaffer P.S. and McDermott L.C. (2005): A research-based approach to improving student understanding of the vector nature of kinematical concepts, *Am. J. Phys.* 73 (10), 921-931.
- Schwarz, C. (2009). Developing preservice elementary teachers' knowledge and practices through modeling-centered scientific inquiry, *Science Education*, 93 (4), 720-744.
- Sciarretta R., Stilli R., Vicentini M. (1990) Le proprietà termiche della materia. I- II. *LFNS XXIII.*
- Schuster D., Cobern W. W., Applegate B., Schwartz R. S., and Undreiu A. (2008) Assessing PCK Of Inquiry Science Teaching, <http://www.wmich.edu/science/inquiry-items/papers.html> .
- Schuster D., Cobern W. W., Applegate B., Schwartz R. S., and Undreiu A. (2009) Assessing PCK of Inquiry Physics Teaching, Invited Talk, AAPT winter Conference Chicago 2009.
- Shulman L. (1987). *Knowledge and teaching: Foundations of the new reform*, *Harvard Educ. Rev.*, 57(1), 1Y22.
- Sokoloff, D.R., Thornton, R.K., (1999) Learning motion concepts using real-time microcomputer-based laboratory tools, *Am. J. Phys.* 58 (9), p. 858-867.
- Sokoloff D. R., Thornton R. K., Laws P. W. (2004) *Real Time Physics*, Wiley, NY.
- Tepner O., Witner S. (2011) Chemistry Teachers' Content Knowledge and Its Correlation to PCK, [http://www.esera2011.fr/images/stories/ESERA\\_\\_2011\\_Detailed\\_Prog\\_SOP\\_\\_Symp.pdf](http://www.esera2011.fr/images/stories/ESERA__2011_Detailed_Prog_SOP__Symp.pdf)
- Tiberghien A: (1986) Rassegna critica sulle ricerche che tendono a chiarire il significato dei concetti di calore e temperatura per gli allievi dai 10 ai 16 anni, *LFNS*, XIX, 2, p. 140.
- Vicentini M., Meyer M. (1996) *Didattica della fisica*, La Nuova Italia, Firenze.
- Viennot L. (2002) *Enseigner la physique*, De Boeck, Bruxelles.
- Viennot L. (2003) *Teaching Physics*, London: Kluwer Publishers.
- Wittmann M.C., Steinberg R.N., Redish E.D. (2004) *Activity –Based Tutorials*, Wiley, NY.

## **Problems in teaching physics in primary and secondary school, as seen by young Polish she-teachers**

Magdalena Sadowska<sup>1)</sup>, Anna Kamińska<sup>2)</sup>

1) *Institute of Physics, Nicolaus Copernicus University, 87100 Toruń, Poland*

2) *Institute of Physics, Pomeranian Academy, 76200 Słupsk, Poland*

**Abstract:** In recent years, in spite of the availability of information on Internet and educational TVs, Physics became one of the less popular subjects in Polish schools. Reasons are numerous, and should be searched first of all in the system of Physics teachers training. Questioning young teachers on their problems is one of the way to reach the relevant solutions.

### **Introduction**

The educational problem of faint interest in Physics lies not only on the side of pupils but also on the teachers' one. Teaching is frequently done in a boring manner: mainly textbook reading during lessons, instead of real experiments [1] or multimedia teaching methods [2]. Lesson are schematic, with no innovative scenarios, like role-playing, reporting, competitions and so on. A negative perception of Physics creates a kind of a negative feedback – in lower secondary school (Gymnasium) Physics lessons are reduced to the very minimum of 4 hours in total, in the whole 3-years cycle. A way of overcoming this difficulty would be making physics interdisciplinary, i.e. teaching Science, with element of Biology, Geography, Astronomy, instead of Physics alone. Unfortunately, no Polish university prepares teachers to such a role.

Another problem are poorly equipped laboratories, usually possessing only old experiments, with no explanations or teaching scenarios. Innovative textbooks would be required and new experimental set-ups. To overcome this problem we prepared new experiments, from electromagnetism [3] to computer guided laboratories [4]. We proposed some innovations for the textbook at the first level of Gymnasium [5], like introducing elements of the Material Science, Astronomy, Chemistry. The tradition teaching only kinematics, with numerous mathematical formula, essentially to be remembered, is too boring. A new list of experiments desired has been recently announced by the Ministry of Educations. Again, explanations and scenarios are needed [6].

### **Problem no. 1: bureaucracy**

M. Sadowska: "I have been teaching since 5 years and I've experienced two changes of national curriculum in Mathematics and one change in Physics. There is a lot of bureaucracy in Polish system of education. It means that Polish teachers have to create lot of documents – different types of plans such as: educational plan, preventive plan, result plan, corrective plan etc. Changes in national curricula lead to changes in teacher's documents. Instead of preparing new interesting lessons teachers have to create new documents. Those changes make the work with students much more difficult because materials become out of date and the teacher is obligated to create new ones. Using the word 'material' I mean worksheets, Power Point presentations, tests etc. It is easier to improve the 'old' material than create a new one (which is time-consuming) that is obligated by changes in educational law.

### **Problem 2: quality of textbooks**

First, there is a lot of educational publishers in Poland that in many different ways try to convince teachers to select their textbooks. There are several handbooks for students being more or less on the same educational level; moreover the same publisher frequently sells two different types of handbooks.

The changes in curriculum result in "small" changes in handbooks. Publishers delete some chapters from the old textbooks, sometimes without making appropriate corrections or explanations. Publishers want to be on time with new student books. Textbooks are written quickly because they must be available for students very fast. Quick changes in books cause that they are inaccessible and fuzzy for students. There is possibility that in handbooks there are misprints, misleading conceptions i.e. inaccurate drawings or photos, chapters without good introduction, chapters without examples or with very difficult examples etc. Moreover lot of books have only one or two authors who are not able to notice some shortcoming in handbooks.

Lets analyse first lesson about electromagnetism for third class of low secondary school that is published in two very popular handbooks. First textbook is published by "Gdańskie Wydawnictwo Oświatowe", its authors are Krzysztof Horodecki and Artur Ludwikowski [6].

Comments about this lesson:

1. In paragraph „Magnetic poles of magnets” there are written names of poles without any experiment, in previous paragraph there is no introduction about magnetic poles. The student has to believe that there are two types of magnetic poles and he/she doesn't have any proofs that author of textbook are right. And what about magnetic monopolies?
2. A misleading fact is that the north magnetic pole is marked by blue and south magnetic pole is marked by red. We know that in some countries the north pole is marked by green. In my school laboratory I have magnet which north pole is marked by red and south pole is marked by blue.
3. There are misleading photographies. We can't see on which picture magnets attract themselves and on which they repel.
4. A picture shows arrangement of iron filings in magnetic field. The student doesn't know how magnet is arranged under a paper because the magnet is not shown.
5. A picture shows that lines of the magnetic field disperse not only from magnetic poles but also from sidelong of the magnetic pole. Has this picture been checked with the scientific literature?
6. The Student reads only about ferromagnetic materials. After reading this paragraph he/she doesn't know about another material's types, I mean diamagnetic and paramagnetic. There is a lack of information that magnetic characteristic changes with temperature's change. It would be much easier to start speaking about "magnetic" and "non-magnetic" materials at the very beginning.

A second textbook is published by "OPERON", its author is Roman Grzybowski [7].

Comments about lessons in that book:

1. There is a picture that shows magnets. There are letters describing magnetic poles but in this paragraph there is no comment about poles. The student must go further to find information about magnetic poles.
2. There is lot of schemes how to make experiments. In my opinion there should be also photos showing how to make them because students have to do them by themselves. Description of making experiments are quite good.
3. *Definition: Magnetic field exist in space in which magnetic forces act on a moving charge.* Such a definition of the magnetic field, via Lorentz force, is scientifically correct and is used in several university textbooks. However, it is very difficult and student can't understand it.

### **Solution of the problem no 2: "quality of textbooks"**

Our Department of the Education of Physics proposes solution in this case. We prepared a handbook of Physics called "*Torunski poręcznik do fizyki*". It was written as supplementary material that is useful for students of low-secondary schools (Gymnasium). Authors of this



textbook would like to help students in creating their knowledge about the world. Next to obligatory material in *"Torunski porecznik do fizyki"* authors present the current knowledge, its use in everyday life, technology, medicine etc. This handbook doesn't focus on requirements of national curriculum but on the interdisciplinary of Physics and its practical use. Aims of the textbook are: interest students in Physics, increase of learning motivation, stimulate to getting knowledge about modern science and technology. They hope that students understand meaning of learning and technological progress instead of formal school knowledge. At the end of the textbook authors underline that adults should know f.e. what kind of diagnostic devices and physical phenomenon are used in medicine.

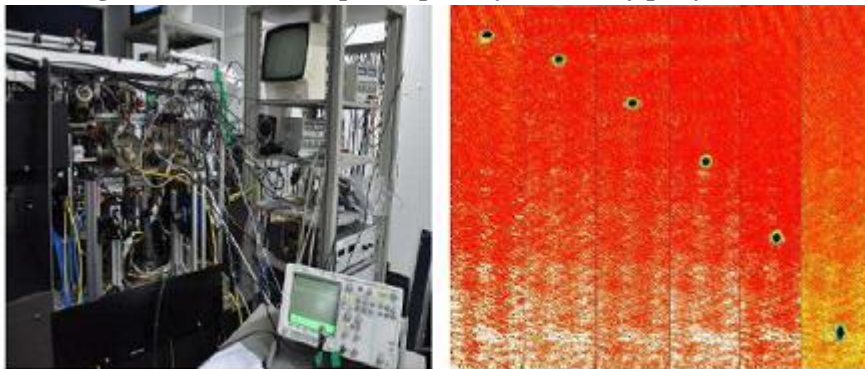
Example of lesson about state of matter

In every traditional textbook there is a list of state of matter that consists: solid, liquid and gaseous state. None of handbook doesn't show or present different state of aggregation. Textbook should show the modern knowledge about science so it might present others state of matter such as: plasma, liquid crystals, condensate of Bose - Einstein. This information students find in *"Torunski porecznik"*. Moreover they can see f.e. different use of liquid crystals (see fig.1).



Fot. 1.16 Nietypowe stany skupienia: a) szkło nie ma struktury krystalicznej, stąd jest czasem klasyfikowane jako ciecz „przechłodzona”; b) ciekłe kryształy, stosowany w niektórych wyświetlaczach telefonów i monitorach TV; c) „silly putty” – polimer silikonowy, plastyczny lub sprężysty, w zależności od szybkości deformacji; d) super lepka, samoprzelewająca się ciecz – raz rozpoczęte przelewanie będzie trwało tak długo, dopóki nie wyczerpie się zapas cieczy w górnej szklance; e) nitiol – stop niklu i tytanu wykazujący pamięć kształtu: zgięty, wyprostuje się w strumieniu ciepłego powietrza z suszarki do włosów.

**Fig.1. State of matter: glass as overcooled liquid, liquid crystals, "sally putty" and other [5].**



Fot.1.17 a) Aparatura służąca wytworzeniu najniżniejszego stany skupienia – kondensatu Bosego – Einsteina (laboratorium FAMO w Toruniu); b) spadanie kondensatu podlega tym samym prawom grawitacji, co spadanie kamienia.

**Fig.2. Apparatus for creating condensate of Bose - Einstein used in FAMO laboratory in Torun.**

After few lessons with *"Torunski porecznik do fizyki"* twenty students of Zespół Szkol in Kalisz (Poland) noted it. They could give notes from one to five and one it was the worse of note and five - the best.

Element of textbook	Graphics	Number of figures and photos	Number and quality of graphs	Number of examples of solve problems	Number of examples from everyday life	Strikeout of definitions and formulas	Language of narration	Together
<b>Average note</b>	4,6	4,6	3,7	3,8	4,2	4,5	4,5	<b>4,3</b>

**Tab.1.** Students' note of the textbook - "*Torunski porecznik do fizyki*". Analyzes was made by M.S.

### **Problem no 3: Physics' laboratory in school**

In schools' laboratories there are old experimental sets that are usually incomplete. There is also a problem that young teachers have difficulties because studies do not prepare them to work in school with old sets. Schools are not able to buy new ones because in their budgets always are some more important expenditures. There is also a possibility that an experiment set is available in school but the teacher does not use it because she/he doesn't have facilities to make experiment (e.g. he/she has: lesson in a classroom not in a laboratory, too little time). In school laboratories experiments controlled by computers are completely absent. In my city (Kalisz) in a low-secondary school I have not even seen such an experiment. Some of high-secondary schools have experiment sets such as COACHLAB or PASCO but in Polish schools it is very sporadic.

Another problem is fact that some of experiments should be done by students (it is obligatory because it is written in national curriculum). It is often impossible because school laboratory has one or two sets but in class there is about 25 – 30 students.

### **Solution of the problem no : "Physics' laboratory in school"**

#### ***Exhibitions***

Polish Universities try to help schools in this problem opening their laboratories, organizing lessons for students of lower-secondary schools or exhibitions for children and teenagers. Nowadays science exhibitions are integral part of every popular-scientific events.

In Poland the first exhibitions was organized by Pomeranian Academy in Slupsk in 1998. The first exhibition was visited by fourteen thousands people for two weeks. The interest was so big that it was organized virtual exhibition called "Physics and Toys" (see on web <http://dydaktyka.fizyka.umk.pl/zabawki1/index-en.html>). Lots of materials were prepared and put into the web but unfortunately there is no publications so far.



**Photo 1.** The exhibition *Physics and Toys*, Primary School number 5 in Slupsk. (AK)



### ***Teaching electromagnetism with a new experimental set***

I started (M.S.) my work with the new electromagnetic set produced at Nicolaus Copernicus University in May 2009. After few (4 -5) lessons I observed that students were very interested in simple experiments that they could see or make.



**Photo 2.** Students of Zespół Szkół in Kalisz during lessons were making experiments with the new set. (M.S.)

Students asked me before lesson what kind of experiments we would make during the lesson and were motivated to come to Physics lesson. The school year was finishing so I could repeat some parts of material and make experiments. We made about 25 experiments from the list, see [http://dydaktyka.fizyka.umk.pl/Low-Tech\\_kit/html](http://dydaktyka.fizyka.umk.pl/Low-Tech_kit/html).

After this few lessons I asked my students about their opinion about this experiments. Lots of them write that:

- Experiments are very interesting.
- Instructions are clearly.
- I don't have to ask the teacher to help me in making experiment.
- Experiments help me to understand some phenomena.
- I can see that knowledge of Physics is helpful in life.

### **Summary and conclusions**

The most important difficulty in teaching physics in Poland as seen by young she-teachers is bureaucracy.

Other problems which make teaching physics difficult are: the classes are too numerous (sometimes 34 students), school labs are old-fashioned, not sufficiently equipped in computers and experimental sets, the quality of textbooks still leaves a great deal to be desired.

Summarizing we can claim that one of problems is also lack of complex actions that would integrate printed word with multimedia material (f.e. CD-discs) or Internet version of book and finally the lack of exercises for self-learning. Not only our research [9] shows that it is necessary to use "blended-learning".

In spite of all difficulties and problems the view of kids faces making their own discoveries is priceless ☺☺ .

### **References**

[1] See, for example, interactive lessons [http://dydaktyka.fizyka.umk.pl/nowa\\_strona/?q=node/142](http://dydaktyka.fizyka.umk.pl/nowa_strona/?q=node/142)

[2] A. Karbowski, P. Miszta, G. Karwasz, Multimedia textbook on electromagnetism, <http://dydaktyka.fizyka.umk.pl/TPSS/flashFizyka/Elektromagnetyzm.swf>

- [3] M. Sadowska, Electromagnetism, lesson scenarios,  
[http://dydaktyka.fizyka.umk.pl/TPSS/Pliki/Elektromagnetyzm\\_scenariusze\\_lekcji.pdf](http://dydaktyka.fizyka.umk.pl/TPSS/Pliki/Elektromagnetyzm_scenariusze_lekcji.pdf)
- [4] M. Sadowska, PASCO instructions,  
[http://dydaktyka.fizyka.umk.pl/TPSS/Pliki/Elektromagnetyzm\\_scenariusze\\_lekcji.pdf](http://dydaktyka.fizyka.umk.pl/TPSS/Pliki/Elektromagnetyzm_scenariusze_lekcji.pdf)
- [5] G. Karwasz, K. Rochowicz, M. Sadowska, Toruń textbook for physics, Part I, Gimnasium, Mechanics  
[http://dydaktyka.fizyka.umk.pl/TPSS/Pliki/Porecznik\\_1.9.pdf](http://dydaktyka.fizyka.umk.pl/TPSS/Pliki/Porecznik_1.9.pdf)
- [6] K. Gołebiowski et al., 14 experiments for gimnasium, Instructions  
[http://dydaktyka.fizyka.umk.pl/nowa\\_strona/?q=node/143](http://dydaktyka.fizyka.umk.pl/nowa_strona/?q=node/143)
- [7] K. Horodecki, A. Ludwikowski, Fizyka dla gimnazjum 3, GWO, Gdańsk 2008
- [8] R. Grzybowski, Fizyka. Podręcznik 3, OPERON 2008.
- [9] A. Kamińska, *Efektywność dydaktyczna środków multimedialnych w nauczaniu fizyki*, PhD, UMK Toruń, 2009

# **Building a PCK Proposal for Primary Teacher Education in Electrostatics**

Marisa Michellini and Alessandra Mossenta

*Research Unit for Physics Education- Udine University, Italy*

## **Introduction**

Scientific learning implies the challenge of bridging everyday experience and scientific knowledge. Physics Education Research (PER) studies for overcoming conceptual knots in scientific learning suggest to introduce primary school pupils in science education very early, along with the first experiences of interaction with the surrounding world to develop observation and interpretation of phenomena (Michellini 2010). To motivate and promote learning in secondary school, the suggestion is to teach physics in a differentiated way according to the context in which it is applied, taking into account the different approaches, angles of attack, perspectives with which learners look at phenomena, students' spontaneous reasoning and models, learning processes. This produces a task in teacher education: PER has to support with materials and suggestions the professional development of teachers in acquiring new competencies, required by the evolution of our society: the main teachers needs are a reflection on the subject focused on learning goals, a planning of the rationale for innovative teaching/learning paths, a capability to manage learning contexts, an expertise in learning processes analysis. This implies the possibility to provide prospective teachers with the fundamentals of science education in a way allowing them to manage these elements in games, stories, questions of curious children, moments of organized analysis, adapting the subject related content and its teaching to the different perspectives of the pupils (Michellini 2003).

To reach this professionalization for teachers pre-service and in service training aims to integrate content knowledge (CK) and pedagogical knowledge (PK) in order to achieve Pedagogical Content Knowledge (PCK) (Shulman, 1986), a process during which prospective teachers must be supported in their reflections on concepts and methods for incorporating CK and PK. PER materials, as research outcomes and prototypes of teaching/learning paths, can be offered to the teachers as a support for school work planning; they can be supported in their planning and learning analysis to produce a fertile classroom environment, coherent proposals in teaching activity, attention to learning processes.

In this paper we discuss a research based formative intervention for prospective primary teachers (PPT) on electrostatics inspired by these issues.

## **A path on electrostatics**

Electrostatics is the context where some fundamental electromagnetic concepts as charge, (electric) field and potential are introduced; moreover, as our path highlights, it offers the opportunity to deal with the concept of state, the conservation principles, the analysis of microscopic properties in systems through macroscopic phenomena. Electricity is a common topic even in primary school and a field where a broad research pointed several learning difficulties, particularly with regard to electrodynamics (Duit , 2009). This difficulties appear to be linked to difficulties in electrostatics (Benseghir & Closset 1996, Eylon & Ganiel, 1990); therefore research was carried out about the students' reasoning in interpreting simple electrostatics phenomena as electrification by friction and contact, induction and transfer of charge (Furiò et al. 2004, Guruswamy et al. 1997, Duit, & von Rhöneck, 1997). Charge emerged as conceived according to four models: entity created by friction, electric atmosphere, fluid (the most used one), charged particles; the models of charge transfer take into account only charge amounts or Coulomb force; the concept of electric potential turns out to be one of the greatest sources of learning difficulties in both electrostatics and

electrodynamics. Research reveals that learning difficulties are deeply rooted in high levels of education, and poses the challenge of trying to prevent the establishment of deeply rooted reasoning rather than to change it at high age level. It is important to give students opportunities for scientific interpretation of the phenomena in parallel with their first exercises of interpretation, also to form the habit in the physics scientific method that will be a core part in education. Carrying out these activities with students involves training teachers to handle them, so it is necessary not only to fill gaps in subject content resulting from a lack of knowledge, but rather to realize the pedagogical content knowledge (PCK) that would make effective their class activities.

For this scope, focusing on the research on learning processes and on the learning problems, some validated ways of working with pupils and an educational path are produced (Mossenta 2010) and presented to PPT. The concept of charge construction is the main goal, starting from the learning and subject-related knots, in the framework of the Model of Educational Reconstruction (Duit MER-2006). The proposal is organized as a macroscopic exploration of charging processes to individuate properties and states related with a preparation of the observed system. Charge mobility and conservation are analyzed in this context. An introduction of the concept of potential linked to its role in electrostatic phenomena is carried out by means of measurements by on line sensors: the need of the potential emerges from the analysis of some processes of charge transfer, taking also into account the conservation of charge. Focused on the macroscopic properties of the electric interactions, the first part of the proposal aims to build the first level of a coherent interpretation of electrostatics phenomena (fig. 1); the second part has the methodological objective of developing the habit of looking at the experiences as involving global systems (fig. 2). The experiments were planned as starting tools for thinking in developing knowledge in electrostatics; we investigate the effect of the planned chain of experiments in producing the construction of a conservative quantity describing the state of systems, the electric charge, and how it is expressed, particularly among prospective teachers of primary school.

The hypothesis to check is that a training too focused on content rather than provide elements of knowledge produces uncertainties in the management of everyday problems that are not yet known in the training and non-standard examples. Instead, to provide specific operational tools by proposing validated ways and paths that will be experienced with a personal and direct involvement could help prospective teachers to use their teaching skills in context, identifying the value that each issue has for the students and taking the most appropriate educational decisions.



Figure 1: Experiments and materials for the first part of the proposal (Part 1)

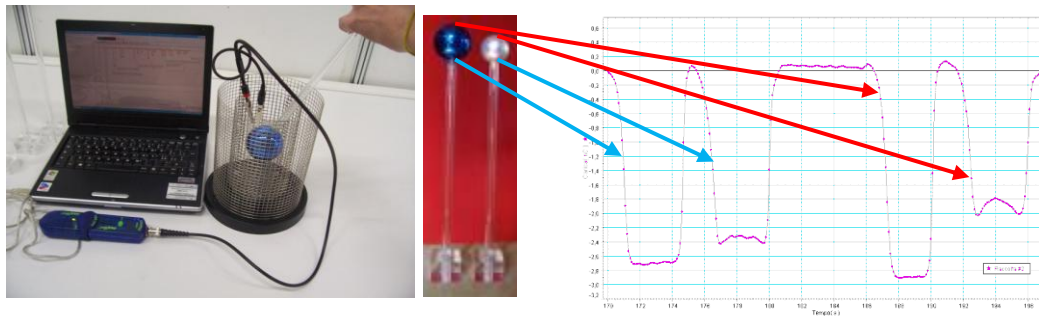


Figure 2; Experiments and measurement with a charge sensor: second part of the proposal (Part 2)

### Context, sample, instruments and methods

We developed a Module of Formative Intervention (MIF) starting from the implementation of the part 1 with pupils and the consequent individuation of a coherent proposal based on Conceptual Laboratories of Operative Exploration (CLOE). A pilot study of the part 2 was carried out with high school students in the perspective of a vertical curricular proposal. The research inquiry learning based MIF was organized from Part 1 + Part 2 for PCK teacher formation. To assess the validity of the hypothesis an activity was proposed to two groups of PPT, group A and group B,  $NA = 64$ ,  $NB = 11$ . The activity was on the same content (on the first part of the path in electrostatics) but implemented according different ways: presenting the proposed experimental teaching path in the first case, with a traditional treatment of the content in the second; then a questionnaire was filled in with questions similar to those already reported in the literature on charge transfer (Guruswamy et al, 1997), asking the questions in the form of identifying ways for an implementation in teaching in the first group (GA), in the form of justification of the claims in the second (GB). The path on the charge transfer was proposed and a second questionnaire was submitted to Group A, with Rogersian interviews of small group of tree PPT to complete data from questionnaire. PPT were asked to comment on the students' ideas on the same phenomena (as emerged from the literature) and to identify educational strategies to correct any identified incorrect idea. These materials provide an analysis of the conceptual change induced by the activity and of the level of expression of the activity effectiveness as regards the acquisition of both disciplinary and pedagogical skills (PCK).

The first part of the questionnaire, common to both groups in its content, proposed six situations of charge transfer: four between metal spheres of equal sizes, two between metal spheres of different sizes. In the first questionnaire students were asked for previsions about the final charge on the spheres in the different situations shown by pictures as in fig. 3 (Q1: What will be the final charge on the spheres in the different situations shown?); then students in Group A were asked about explanations for students (Q2: How would you explain your prevision to a student?) and students in Group B were asked about their own explanation.



Fig. 3: Picture in the questionnaire to ask for the transfer of charge (situation a).

The proposed situations before the contact between the spheres of the same size are:

- a) Sphere A:  $+8 \mu\text{C}$ ; sphere B:  $+2 \mu\text{C}$ .
- b) Sphere A:  $+8 \mu\text{C}$ ; sphere B:  $-2\mu\text{C}$
- c) Sphere A:  $+8 \mu\text{C}$ ; sphere B:  $0\mu\text{C}$
- d) Sphere A:  $-8\mu\text{C}$ ; sphere B:  $+2 \mu\text{C}$  .

Here we analyze this part and the first item in the second part of the questionnaire of GA:

“A child says that there is a transfer between two identical metal objects until each has half of the net initial charge. Do you agree? Which ideas led the children to answer this in your opinion?”

### Research questions

To make a comparison between the two ways to give to the prospective teachers PCK elements, we define the following Research questions:

RQ1: What are the students’ ideas about the transfer of charge in the two groups? Are they local or global, coherent in the different situations proposed? Is it possible to distinguish between the two ways of teaching, as concerns the nature and the features of the students ideas?

RQ2: Do prospective teachers modify their own explanations taking into account the pupils perspective when requested of an explanation for children? In which way?

RQ3: What are the ideas of the prospective teachers about the processes of interpretation in pupils? Do they assume the creativity of pupils as a source to be driven by a careful interpretation of phenomena?

What strategies can be helpful in an effective activity in developing PCK?

### Data and data analysis

Q1: What will be the final charge on the spheres in the different situations shown?

**In situation a**, where the two spheres of the same size were positively charged before their contact, the majority of students (89% of GA and 73% of GB) make a prevision of the same final quantity of charge ( $+5 \mu\text{C}$ ) on each sphere. The other 7/64 GA students (11%) foresee an unchanged situation, explained by the repulsion between charges of the same type: “In this situation the two charges repel because have the same sign”; the other 3/11 GB students (27%) do not answer. Students in majority admit a transfer of charge between the two objects differing only in the amount of their charge; a few students reveal a reasoning according to the Coulomb’s law, preventing a transfer if systems charged with the same kind of charge are involved. All answers are consistent with the conservation of charge.

Situation a: Charge before the contact: Sphere A: $+8 \mu\text{C}$ ; sphere B: $+2 \mu\text{C}$ What will be the final charge on the spheres? ANSWERS	GA N=64	GB N=11
A: $+5\mu\text{C}$ ; B: $+5\mu\text{C}$ .	57 (89%)	8 (73%)
A: $+8\mu\text{C}$ ; B: $+2\mu\text{C}$ .	7 (11%)	
Not answered		3 (27%)

Table 1: Answers about the final charge on spheres in situation a before the contact: Sphere A:  $+8 \mu\text{C}$ ; sphere B:  $+2 \mu\text{C}$ .

**In situation b**, (Sphere A:  $+8 \mu\text{C}$ ; sphere B:  $-2\mu\text{C}$  before their contact), it is possible to recognize the same reasoning concerning the transfer of charge as before; moreover, a few students imagine the neutralization of the less charged sphere as the final state of the systems,

or the same number of charges on each sphere, or claim the idea of an exchange of the signs of the charges on the spheres.

56/64 (88%) students of GA and 6/11 (55%) of GB make a prevision of a net charge equal to the two spheres, with three different representations:

- 43/64 (67%) students of GA and 4/11 (36%) of the GB state a final charge of  $+3 \mu\text{C}$  on each sphere (b1);
- 7/64 (11%) students of GA suggest  $+3 \mu\text{C}$  on the sphere A,  $-2\mu\text{C}$  and  $+5 \mu\text{C}$  on the B (b2);
- 6/64 (9%) students of GA and 2/11 of GB state  $+4\mu\text{C}$  and  $-1\mu\text{C}$  on each sphere (b3).

The representations b2 and b3 are the results of different reasoning about the processes involved in the transfer of charge, the representation b1 involves one of the two previous processes and the idea of disappearing of opposite charges.

8/64 students (13%) in GA and 2/11 in GB give different predictions: relating both spheres (with the same number of charges or an exchange of the charge signs, 3 students) or looking to one sphere, that becomes neutral (3 students in GA, 1 student in GB); 3/11 students (27%) of the GB do not answer. 60/64 students (94%) in GA and 7/11 (64%) in GB give answers consistent with the conservation of charge.

Situation b: Charge before the contact: Sphere A: $+8 \mu\text{C}$ ; sphere B: $-2 \mu\text{C}$ What will be the final charge on the spheres?		MATERA N=64	UDINE N=11
Same amount of charge on each sphere	A: $+3\mu\text{C}$ ; B: $+3\mu\text{C}$ (b1).	43 (67%)	4 (36%)
	A: $+3\mu\text{C}$ ; B: $-2\mu\text{C}$ & $+5\mu\text{C}$ (b2).	7(9%)	
	A: $+4\mu\text{C}$ & $-1\mu\text{C}$ ; B: $+4\mu\text{C}$ & $-1\mu\text{C}$ (b3).	6 (9%)	2
Neutralization of the less charged sphere	A: $+6\mu\text{C}$ ; B: $-2\mu\text{C}$ & $+2\mu\text{C}$ .	3	1
Unchanged situation	A: $+8\mu\text{C}$ ; B: $-2\mu\text{C}$ .	2	
Same number of charges on each sphere	A: $+4\mu\text{C}$ ; B: $-2\mu\text{C}$ & $+2\mu\text{C}$ .	1	
Exchange of sign of the charge	A: $-2\mu\text{C}$ ; B: $+4\mu\text{C}$ .	1	
	A: $-8\mu\text{C}$ ; B: $+2\mu\text{C}$ .	1	
	A: $+4\mu\text{C}$ ; B: $+6\mu\text{C}$ .		1
	Not answered		3 (27%)

Table 2: Answers about the final charge on spheres in situation b before the contact: Sphere A:  $+8 \mu\text{C}$ ; sphere B:  $-2 \mu\text{C}$ .

**In situation c** (Sphere A:  $+8 \mu\text{C}$ ; sphere B:  $0\mu\text{C}$  before their contact) can be recognized the same patterns of reasoning as before. 58/64 (91%) students in GA and 5/11 (45%) in GB state an equal net charge of  $+4 \mu\text{C}$  on the two spheres; 5/64 students (8%) in GA and 3/11 (27%) in GB give different predictions: the situation is expected to be unchanged (2 students in GA and 1 in GB), "The sphere B hasn't got charge and doesn't take anything from A" (GA); the spheres are expected to be charged of the same amount of the two kinds of charge, "by induction":  $+4 \mu\text{C}$  on the sphere A and  $-4\mu\text{C}$  on the B (1 student in GA and 1 in GB);  $+8 \mu\text{C}$  on the sphere A and  $-8\mu\text{C}$  on the B (1 student in GA); finally, the states of the sphere are exchanged for a total transfer of charge,  $0\mu\text{C}$  on the sphere A and  $+4 \mu\text{C}$  on the B (1 student in GA),  $0\mu\text{C}$  on the sphere A and  $+8 \mu\text{C}$  on the B (1 student in GB). 1 student of GA and 3 in

GB do not answered. 60/64 students (94%) in GA and 6/11 (55%) in GB give answers consistent with the conservation of charge.

Situation c: Charge before the contact: Sphere A: +8 $\mu\text{C}$ ; sphere B: 0 $\mu\text{C}$ What will be the final charge on the spheres? ANSWERS	GB	UDINE N=11
A: +4 $\mu\text{C}$ ; B: +4 $\mu\text{C}$ .	58 (91%)	5 (45%)
A: +8 $\mu\text{C}$ ; B: 0 $\mu\text{C}$ .	2	1
A: +4 $\mu\text{C}$ ; B: -4 $\mu\text{C}$	1	1
A: +8 $\mu\text{C}$ ; B: -8 $\mu\text{C}$ .	1	
A: 0 $\mu\text{C}$ ; B: +4 $\mu\text{C}$ .	1	
A: 0 $\mu\text{C}$ ; B: +8 $\mu\text{C}$ .		1
Not answered	1	3 (27%)

Table 3: Answers about the final charge on spheres in situation c before the contact: Sphere A: +8  $\mu\text{C}$ ; sphere B: 0  $\mu\text{C}$ .

Q2 (GA only): How would you explain your prevision to a student?

**Situation a).** As regards the explanation that the 57 prospective teachers stating a final charge of +5  $\mu\text{C}$  on each sphere would pose to the pupils, 44/57 students explain identifying a final state of the system of the spheres corresponding to the configuration of charge reported (category A); 8/57 express only a process that does not need the idea of final state (category B). 37/57 students in both categories explain describing a process. The majority of explanations involves the macroscopic systems of the spheres as acting entities. The state expressed in category A can be equilibrium, without explaining the meaning of this concept, (A1) or the same number of charges (A2). The majority (37/57 students, category A1) of students explain the prevision as corresponding to a state of equilibrium to be reached: of these 37 students, 26 (Category A1.1) describe a process that leads from the initial state to the final state of equilibrium: for 25 students it is a transfer, for 1 a distribution: "nothing happens because like charges repel; brought towards a forcing, the charges realized a distribution balancing each other". A total of 21 students would explain referring to an action of the spheres (the sphere more charged sales/transfers charge), 4 of the charge (the charge moves "to achieve an equilibrium") and 1 student does not introduce an agent ("there was a transfer of charge from A to B reaching an equilibrium of charges"). 11 students (Category A1.2) indicate only the correspondence between the configuration written in the previous answer and the equilibrium, in the form of a final state: reached by the spheres ("the two spheres reach a state of equilibrium", 9 students), or by the charges (1 student: "charges will balance"), or after the contact (1 student "as the ball has a smaller number of +, the contact will make to achieve an equilibrium between the charges"). 7 students (Category A2) indicate the final state as corresponding to the same number of charges (amount of charge) on each sphere: 5 (Category A2.2) state it without indication of a process leading to this state: 2 consider it an aim of the spheres ("the spheres want to achieve the same number of charges") and 3 describe it as a situation resulting from the contact: "after the two spheres touched there will be the same number of positive charges". 2 other students (Category A2.1) consider the same number of charges as a final result: of the process of charge transfer or of the process of cession by the more charged sphere. 8 students (Category B) do not indicate a final state but identify a process able to account for the result: it is an equitably distribution of charges (4 students), a collection and sharing in an equal way of the charges by the balls (3), a situation described step by step without specifying the subject of actions: after the contact there is an amount of charges then divided into the two spheres (1). 1 student indicates only the transfer of charge from the sphere more charged, thus providing an explanation not exhaustive for the



situation stated before. 2 students do not explain, 2 students give an explanation inconsistent with the situation stated for the spheres: it is the same explanation given by the 7 students who state a final situation unchanged, as there will not be transfer because of the repulsion between like charges (not already noted in the literature, Guruswamy et al, 1997).

ITEM A EXPLANATION STRUCTURE	PREVISION: A: $+5\mu\text{C}$ ; B: $+5\mu\text{C}$ ; How would you explain your prevision to a student? CONTENT	NUMBER OF ANSWERS
FINAL STATE 16 (25%)	CHARGE EQUILIBRIUM "Spheres want to reach a charge equilibrium"	11
	SAME AMOUNT OF CHARGE "After the spheres touched there will be the same number of positive charge"	5
FINAL STATE AND PROCESS TO REACH IT 28 (44%)	TRANSFER OF CHARGE TO REACH EQUILIBRIUM "The sphere A, more charged, transfers a part of its charge to the sphere B, creating a charge equilibrium"	25
	TRANSFER OF CHARGE TO REACH THE SAME AMOUNT "The sphere A wanted to transfer some charges to the sphere B to reach the same charge"	2
	CHARGE DISTRIBUTION MAKING EQUILIBRIUM "Charges spread making each other equilibrium"	1
PROCESS ACCOUNTING FOR THE PREVISION 8 (13%)	EQUAL DISTRIBUTION OF CHARGE "The two spheres touch and the positive charges realize an equal distribution"	4
	CHARGE COLLECTION AND THEN SHARING OUT "The two spheres collected all charges and then shared out them equally between themselves"	4
PARTIAL EXPLANATION	TRANSFER OF CHARGE FROM A TO B	1
NO CONSISTENCY (3%)	"In this situation the two spheres have the same kind of charge, so they cannot touch/repel"	2
NOT ANS. (3%)		2

Table 4: answers about the explanation for pupils in situation a: prevision of a final situation with the same amount of charge on each sphere

**Situations b, c, d.** The analysis of the answers for the situation b, c, d, shows that among the 26 students in the category A1.1, 24 students show consistent answers in situations b and d (which differed only in the signs of the charges on the spheres). 21 students converge towards a model that explains the prediction concerning the final charge on the spheres as a sale/transfer by the spheres (as they did in situation a, now adding the idea of cancelling of opposite charges), but with differences: 18 students refer to a one-way transfer by the sphere ("the two spheres, after they touched, reach an equilibrium state generated by the fact that two charges are cancelled and 3 charges are transferred to the sphere B"), and 4 express a two-ways transfer: "to achieve an equilibrium between the two spheres the sphere B transfers a charge - to the sphere A and in turn the sphere A will transfer 4 charges + to the sphere B. So we will have that the charge - that there is in both spheres cancel a +, then you will have in the sphere A 3 charges + and 3 charges in the sphere B". 2 students consider for the situations b/d that there will be a transfer until the neutralization of the less charged sphere ("Touching the spheres, the sphere B takes 2 positive charges from the sphere A and becomes neutral"), and an unchanged situation c for the neutrality of one of the two spheres ("The sphere B has no charge and takes nothing from the sphere A and so it remains neutral"). 3 other students of the category A1.2 take the wording b3 (1 of them explains with a process where the sphere A gives to B and takes from it charges), 1 the b2 (explained with a transfer for the equilibrium without introducing the idea of neutralization) and 7 the b1: 2 of them express a process. For

5/7 students of category A2, equilibrium is identified with the same number of charges, and two other students introduce processes to explain, besides the two who already had made it in the situation a. One of the students maintaining the explanation based on the same number of charges images for the situation b a charge of  $+4\mu\text{C}$  on the sphere A,  $-2\mu\text{C}$  and  $+2\mu\text{C}$  on the sphere B, explaining: "the spheres want to reach the same number of charges, or elements" without taking into account both the effect of neutralization and the conservation of charge. In situation d this student introduces a kind of mathematical procedure: "making the algebraic sum the number of charges equals". Among the 8 students in the group B, 5 maintain the models expressed in situation a, 1 does not provide an explanation, 2 give inconsistent answers, the 3 who had thought of a distribution charges in the situation a report the same model in the following situations (1 does not provide explanation), 2 among the of 4 who had looked at a collection and sharing by the two spheres in the situation a mostly use the same model (shifted to a transfer in case c), 2 give inconsistent answers, like the rest of the 9 students who in situation a predicted a situation unchanged (6 of them explain with a transfer to reach equilibrium the situations b and d, with a distribution the situation a) or gave inconsistent answers.

10/64 students (16%) express their explanations using explicit expressions of intention, obligation, desire, characterizing in an animistic way the behavior of physical entities: in 8 cases, these explanations claim only final states of the spheres, "the spheres want to achieve equilibrium" in 2 cases the explanation is a description of a process. A lower level of animism can also be seen in the feature of the spheres or the charges of making actions, as sale or transfer, reported by most students.

### **Explanation of predictions in GB**

In Group B, answers related to the same final amount of charge on each sphere are explained with processes as in Group A: for some students (attractive) forces are the starting point for the transfer, in some cases the idea of equilibrium is expressed only in situation a and not transferred in the other situations where the systems are not seen in the same condition of charge after their contact. 2/11 students explain their predictions in situations a and c with a charge transfer process to reach equilibrium, "the charge passes from the more charged sphere to the less charged until the two balance each other"; this transfer becomes a two-ways transfer in situations b and d, to reach a final state of  $+4\mu\text{C}$  and  $-1\mu\text{C}$  in situation b (with reversed signs in the situation d). Other 2/11 students express the same processes but connect them to the attractive interaction between charges in situations b and d: "The spheres have opposite sign, so they attract, there is a direct interaction and they exchange charges". Situation a highlights in one of these answers the learning problems related to the concept of interaction: "The sphere A gives some charges to the sphere B that B acquires and there is an interaction in both directions". In situation a other 2 students refer to a final state that the spheres must reach: in 1 case it is the equilibrium, in 1 it is undefined: "achieving a similar state"; 1 other student explains through a process of distribution: "on the two spheres the same amount of charge distributes". These 3 students in the remaining situations, not always complete, express previsions of different final charges on the two spheres, with explanations based on the greater influence of more charged sphere (2 students), or without explaining. 3/11 students do not answer at all. Answers in GA are more coherent across the different proposed situations than answers in GB; the processes expressed are the same, but some students in GB cannot find an explanation at all.

### **Second part of the questionnaire (GA)**

The first question in the second part of the questionnaire asked students (N=61) for a discussion about a pupil' claim when asked about the transfer:

A child says that there is a transfer between two identical metal objects until each has half of the net initial charge. Do you agree? Which ideas led the child to answer this in your opinion?  
Q1: Do you agree?

51/61 students agree with the proposed claim, 7/61 do not agree, 3/61 did not answer.

Q2: Which ideas led the child to answer this in your opinion?

14/61 (23%) students see in the pupil's answer the same process they imagine to use as explanation (equally divided into transfer "Charges transfer until the spheres are equally charged, cancelling 2 charges" and spread out "Charges spread out equally, with a cancelling of two positive charges by the two negative charges"); 14/61 report that pupils have the idea of final state, justified (differently from their explanations) by the features of the observed system (equal size of the spheres: "Spheres with an equal diameter will reach equilibrium" "Equal spheres suggest the idea of equal charges"); 9/61 (15%) students say that pupils find their idea as a possibility validated by the final state of equilibrium, as a constrain for the system "Because in this manner there will be an equilibrium between spheres"; 12/61 (20%) claim that children think according mathematical procedures "He takes 2 from 8 and obtains 6 and then divides equally", 2 students think that pupils can answer in this way because they know the issue "Because the child knows that if two bodies with different charges are in contact an equilibrium between charges are created". The answers "no" aims to give to the children a model different from transfer; 2 students wrote only the ideas of children: one, a process; the other a mathematical procedure.

## **Discussion**

In all cases the GB students show greater difficulty responding than GA students (27% cannot make predictions on the final state): they seem to be blocked. The learning problems arisen in the largest group are also found in the smaller group; mostly they are the learning difficulties / misconceptions highlighted in the literature. Traditional treatment of the contents (even if very good and rigorous) does not seem to help students' reasoning, in GB: the students of this group show difficulties in connecting theory and the proposed simple new situations. The explanations are almost always written in the same way in the groups, although in the GA students were asked how to explain the topic to children: teachers tend to propose to their students the theoretical formulation they learned during their instruction, or their explanation; alternatively, they use terms bringing to mind animism of entities/objects and fairy-tale narrative ways in introducing the processes. In Group A explanations are mostly referred to a process and to states, and this feature increases examining more than one situation. A minority of students gives explanations taking into account the Coulomb force applied to the charges on the spheres as they were single point-like charges instead of groups of charges interacting. A few students use terms as "induction" giving them an explicatory value, without a real understanding of their meaning. On the contrary, two ideas drive their explanations, one explicit, equilibrium as an aim, an habit, and the conservation of charge. When asked about the pupils' ideas, some students admit that pupils can relate (but only for similarities) features of the observed systems and state of charge; others refer that the pupils' ideas are related to a mathematical procedure not supported by reasoning.

## **Conclusions**

The way to teach prospective primary teachers (PPT) by proposing a subject related content knowledge does not provide them of better tools more than a discussion that brings out the same concepts from simple experiments designed after a reconstruction of the pedagogical content perspective (MER).

PPT invent simple models when they put themselves in teaching perspective. This models are often local, not coherent, different for different situations. PPT suggest explanations based on

a final goal that systems have (a state, not explicit), but they do not pay attention to the meaning that students attribute to the concepts (equilibrium, assumed to have a unique meaning and not described) or to the multiple interpretations. The different processes individuated in reaching the goal are possible freedom dimension of the processes. The conservation of charge, employed in explanations in an implicit way, is not recognized as a constraint that can help in selecting the final states and the processes admitted: an opportunity to support reasoning to be recognized.

When asked about students' ideas, PPT attributed to the pupils math procedures instead of reasoning and propose their invented models to enrich their ideas: there is a need of qualitative reasoning both as personal explanations and as teaching tool.

If the sentence of the student is considered wrong PPT refuse the model or suggest a procedure: they suggest the idea of the possibility of one way only for interpreting situations, or prefer the product (the value obtained whit a mathematical procedure).

In the second part of the questionnaire the idea of equilibrium is not more only a goal but become a condition for individuating the final state of the observed systems: it expresses the need of a driver for equilibrium: the idea of potential as a quantity regulating the process of charge exchange.

We argue that a macroscopic approach (as the one proposed to PPT) is useful to see how we can infer information on micro-world from phenomena analysis. Emerges that to explain changes is a fertile task to recognize states and processes, and relevant quantities for the interpretation. In this context there are critical situation that are fertile for conceptual discussion and for clarification of some crucial concepts as potential. As concerns the pedagogical approach in building formal thinking, emerges that the link between CK and PK cannot be leaved solely to PPT: an important support in analysis of reasoning and micro-level planning have to be given to the students. Searching for a rationale for the discussion of the concepts is an important task both in teacher formation and in planning school activities.

## References

- Benseghir A. & Closset J.L., 1996, The electrostatics – electrokinetics transition. Historical and educational difficulties, *International Journal of Science Education*, 18 (2) 179 -191
- Eylon B. & Ganiel U., 1990, Macro – micro relationship: the missing link between electrostatics and electrodynamics in students' reasoning, *International Journal of Science Education*, 12 (1) 79 -94
- Duit, R. (2009). Bibliography STCSE – Teachers' and Students' Conceptions and Science Education. Kiel, Germany: IPN – Leibniz Institute for Science Education (<http://www.ipn.uni-kiel.de/aktuell/stcse/stcse.html>)
- Duit, R., & von Rhöneck, C, Learning and understanding key concepts of electricity, from *Connecting Research in Physics Education with Teacher Education*, edited by Tiberghien, A., Jossem, E.L., and Barojas, J, 1997,1998 I.C.P.E.
- Duit R., 2006, Science Education Research - An Indispensable Prerequisite for Improving Instructional Practice, ESERA Summer School, Braga, (2006) at <http://www.naturfagsenteret.no/esera/summerschool2006.html>.
- Furió, C., Guisasola, J. & Almudí, J. M. 2004, *Canadian Journal of Science, Mathematics and technology education*, 4 (3) 291 - 313
- Guruswamy, C., Somers, M. D. & Hussey, R. G., 1997, *Physics Education*, 32 (2) 91 – 96
- Shulman L. S. 1986 *Educational Researcher*, 15( 2) 4
- Michellini M, ed. 2003, *Quality Development in the Teacher Education and Training*, Girep book of selected papers, Forum, Udine [ISBN 88-8420-158-6]
- Michellini M, 2010, *Building bridges between common sense ideas and a physics description of phenomena to develop formal thinking*, *New Trends in Science and Technology Education*. Selected Paper, vol. 1, eds. L.Menabue and G.Santoro, CLUEB, Bologna 2010, ISBN 978-88-491-3392-9, p.257-274
- Mossenta A, Michellini M, *Conservation of Charge to understand potential using on-line charge measurements*, in *Multimedia in Physics Teaching and Learning*, Michellini M, Lambourne R, Mathelisch L eds, SIF, Bologna 2010 and in *Il Nuovo Cimento*, 33 C, 3, 2010 NIFCAS 33(3) 1-238 (2010) (DOI 10.13932/ncc/i2010-10620-3) NIFCAS 33(3) 1-238 (2010) [ISSN 2037-4909] p.205

# Physics Learning Tasks for Students with Special Educational Needs: Disabled and Gifted

Josef Trna, Eva Trnova & Lucie Makydova  
Faculty of Education, Masaryk University  
Brno, Czech Republic  
[trna@ped.muni.cz](mailto:trna@ped.muni.cz)

## **Abstract**

*The educational development of every individual student seems to be a future imperative also in physics education. Each student can be considered as a learner with special educational needs. A physics learning task is one of the most effective educational instruments in physics education. Disabled and gifted students are students with special educational needs. Disabled students with specific learning disabilities meet many problems when they solve physics learning tasks. That is why effectiveness of physics educational process decreases. The study presents research results of concrete symptoms of Specific Learning Disabilities during the solving of physics learning tasks. The research outcomes are presented in the form of the list of symptoms of these disabilities and examples of symptoms from a case study of a student with dyscalculia. Innovations of learning tasks for disabled students are presented as therapy including compensatory aids for the solving of physics learning tasks. Physics learning tasks for gifted students should be presented in a special form useful for a development of this giftedness. Cognitive motivation is an important part of the student's giftedness. The study presents research results of physics learning tasks for gifted students based on the motivational factor analysis in physics education. Physics experiments strongly motivate ungifted and gifted students. A physics learning task based on an experiment has a strong motivational influence. This kind of learning tasks is unfortunately rare in physics education. Special forms of these learning tasks were created: problem physics learning tasks, play physics learning tasks and modification physics learning tasks. Learning tasks based on physics experiment can be widely used within all teaching phases. These physics learning tasks upgrade students' motivation and should be used for development of giftedness.*

## **1 Introduction**

Many students have educational problems. A future imperative in education seems to be the individual educational development of every student. Each student can be considered as a learner with special educational needs. We should prepare an appropriate educational technology also in science and physics education. This study tries to open the problem of individual approach in development of every student in physics and in science education.

## **2 Physics learning tasks**

Learning tasks are very important educational and also motivational tools in physics education. Not every learning task can be an effective educational stimulus. Talyzinova said: "...without problems, without tasks, neither skills nor knowledge can be acquired" (Talyzinova, 1988, p. 76). We define the learning task as a specific requirement set to students. Learning tasks have specific forms. Elementary tasks demand only memory reproduction of knowledge. Complicated tasks call for creative thinking. Learning tasks perform different roles in education. These roles are primarily linked to the teaching phase: motivation, exposition, fixation, diagnostics and application (Vaculová, Trna & Janík, 2008).

We can use more sorts criteria such as: the level of calculations during task solution (quantitative and qualitative learning tasks), the form of setting and solution (verbal,

numerical, graphic and experimental learning tasks), and the teaching phase (motivational, expository, fixation, diagnostics and application learning tasks). Tollingerova classified learning tasks on the basis of Bloom taxonomy into five categories. The sort criterion is difficulty of cognitive operations needed for learning task solution (Tollingerova, 1970):

- Learning tasks demanding memory reproduction of knowledge when students use memory operations
- Learning tasks demanding simple mental operations with knowledge such as analysis, synthesis, comparison, and categorization
- Learning tasks demanding complicated mental operations with knowledge such as induction, deduction, interpretation, transformation, and verification
- Learning tasks demanding knowledge interpretation when students interpret not only the results of their own solution but also its progress, conditions and phases
- Learning tasks demanding creative thinking based on the previous operations, ability to combine these operations into wider complexes and come to new solutions

Physics learning tasks play important role in physics education, but also in teaching/learning of students with special educational needs: especially disabled and gifted.

### **3 Specific learning disabilities in physics education**

Most frequent specific learning disabilities in physics education are:

- Dyslexia
- Dysgraphia
- Dyscalculia
- Combined disabilities - e.g. syndrome ADHD - Attention Deficit Hyperactivity Disorder which often co-exist of hyperactivity and attentional fatigue (Biederman, 1998)

We focus on dyscalculia in this study.

Dyscalculia is defined as a genetically-linked learning disability which affects a person's ability to understand, remember, or manipulate numbers or number facts (Dehaene, 1997). The term is often used to refer specifically to the inability to perform arithmetic operations, but it is also defined as a more fundamental inability to conceptualize numbers as abstract concepts of comparative quantities. Exteriorization of dyscalculia has these forms:

- Inability to read a sequence of numbers (e.g. turning 23 into 32)
- Difficulties with arithmetic (e.g. confusing the signs: +, -, / and x)
- Difficulty with tables and mental arithmetic
- Difficulty with measurement guessing (e.g. distance )
- Inability to acquire sequences, mathematical concepts and formulae
- A phobia of mathematics topics and coherences in extreme stage

Students with dyscalculia can be endowed with over-sensitivity to noise, light, and smell. On the other hand they are not able to filter and tune out unwanted impressions. They might have a well-developed sense of imagination, possibly as cognitive compensation to mathematical disability.

### **4 Physics learning tasks for students with specific learning disabilities**

Students with specific learning disabilities meet a lot of problems when they solve learning tasks in physics education. That is why the effectiveness of the educational process dramatically decreases.

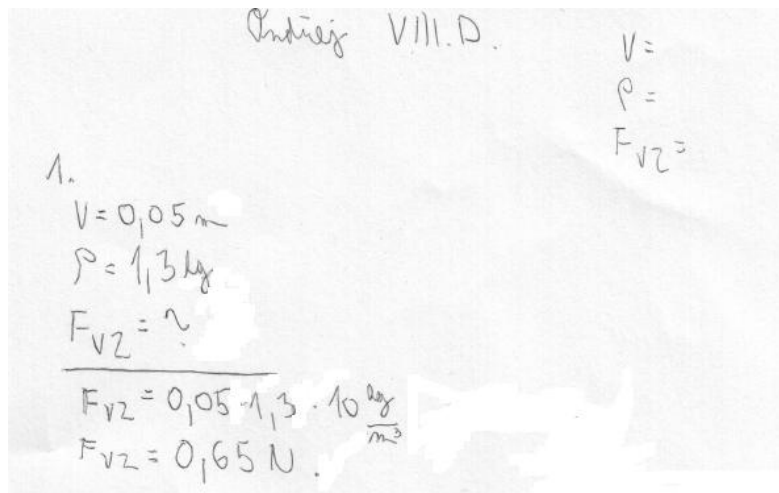
Our research outcomes are presented in the form of the list of symptoms of dyscalculia disability and examples of symptoms from case study of the student with dyscalculia.

Innovations of physics learning tasks for these students are demonstrated as therapy including compensatory aids for the solving of physics learning tasks.

We present three examples of the solving of physics learning task from one student. His name is Ondrej. We studied his development of his solving of physics learning task during three years. This case study covered his age from 13 to 15 years:

**Example 1 (eighth grade)**

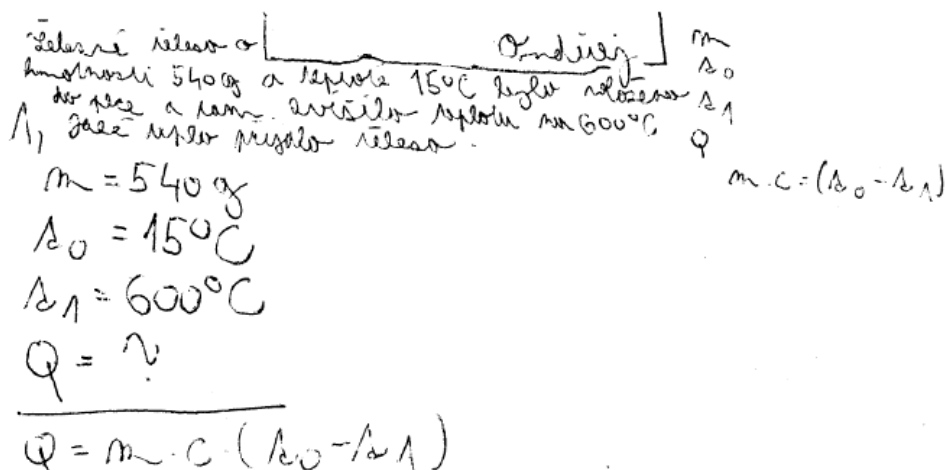
Calculate the lifting force which upholds a body with a volume of  $0,05 \text{ m}^3$  in air. The air density is  $1,3 \text{ kg/m}^3$ .



**Figure 1. Lifting force**

**Example 2 (early ninth grade)**

An iron body of mass 540 g and temperature of  $15^\circ\text{C}$  was put into a heating furnace of  $600^\circ\text{C}$ . Calculate the accumulated heat.



**Figure 2. Accumulation of heat**

**Example 3(late ninth grade)**

What was the heat loss of 3 kg water, if the water temperature changed from 90 °C to 25 °C?  
What work was done by a lift truck, if a box of mass 300 kg was taken up to the height of 2 m?

4.  $Q = m \cdot c \cdot (t_0 - t)$

$m = 3 \text{ kg}$   
 $t_0 = 90^\circ\text{C}$   
 $t = 25^\circ\text{C}$   
 $c = 4,18 \frac{\text{J}}{\text{kg} \cdot ^\circ\text{C}}$   
 $Q = ? \text{ J}$

---

$Q = m \cdot c \cdot (t_0 - t)$   
 $Q = 3 \text{ kg} \cdot 4,18 \frac{\text{J}}{\text{kg} \cdot ^\circ\text{C}} \cdot (75^\circ\text{C})$   
 $Q = 934,5 \text{ J} = 934,5 \text{ kJ}$

*Temperaturunterschied zwischen 90, 25 Grad.*

1.  $m = ?$   
 $m = 300 \text{ kg}$   
 $h = 2 \text{ m}$   
 $W = ?$

---

$W = m \cdot g \cdot h$   
 $W = 300 \text{ kg} \cdot 9,81 \frac{\text{m}}{\text{s}^2} \cdot 2 \text{ m}$   
 $W = 5886 \text{ J} = 5,886 \text{ kJ}$

**Figure 3. Heat and work**

The students’ main problems with dyscalculia when he solved physics learning tasks were:

- Difficulties with arithmetic
- Difficulties with conversion of physics units
- Difficulties with data processing
- Inability to remember and use of physics-mathematics concepts, rules and formulae
- Difficulties with self-reflection of the solving of a physics learning task
- Inability to explain the solution of a learning task

An open question is to find the “therapy” which leads to students’ success in the solving of physics learning tasks. No common therapy for dyscalculia has been properly verified to be effective (Henderson, Came & Brough, 2003). Our proposal of educational therapy in the form of teaching/learning methods/strategies is:

- To provide disabled students with the solution of a physics learning task as an example
- To provide disabled students with special aids such as a structured overview of formulae and units, aids for the conversion of physics units etc.
- To use a simple and transparent graphic form of given physics learning tasks
- To limit the time needed for solving of physics learning tasks
- To use more qualitative, verbal, graphic and experimental learning tasks

We identify a set of research questions for our future research and development activities:

- To discover typical and frequent problems of disabled students in process the solving of learning tasks
- To study cognitive structures of understanding of physics formula by disabled students
- To state rules for diagnosis and evaluation of knowledge/skills of disabled students
- To produce compensating aids for disabled students

**5 Giftedness in physics education**

Gifted students are also students with special educational needs in physics education (Amatrong, 1998). Cognitive motivation is an important part of the student’s giftedness.



Specific learning tasks suitable for development of giftedness should be created. We discovered that a physics learning task based on an experiment has a strong cognitive motivational influence for gifted students. That is why the educational application of this type of physics learning tasks is important for development of gifted students. Physics learning tasks based on an experiment are unfortunately rare in physics education.

## 6 Physics learning tasks for gifted students

Three specific kinds of learning tasks based on an experiment for gifted students were created: problem physics learning tasks, play physics learning tasks and modification physics learning tasks. These physics learning tasks combine together and upgrade students' cognitive motivation and should be used for development of giftedness.

### 6.1 Physics learning tasks for gifted students - problem physics learning tasks

Problem based teaching is a significant innovation of science and physics education. Motivational effectiveness of problem learning tasks results from increasing students' cognitive needs and their consequent satisfying by way of students' active cognitive working (Trna & Trnova, 2006). Psychological base of increasing cognitive needs is "perception and conceptual conflict" (Berlyne, 1997). This conflict becomes an incentive which causes strong motivation and thus students become active which heads towards conflict elimination and satisfaction of the need. An induction of that conflict has several variants:

- Surprise
- Paradox
- Doubt
- Uncertainty
- Difficulty

An example of problem physics learning tasks follows (Trna, 2008):

#### ***Problem cylinder***

*We glue a coin on the base of a polystyrene cylinder. The coin has the same diameter as the cylinder. Height of the polystyrene cylinder will be adapted so that only the coin extends from the surface of the water. We turn the cylinder coin down and place it in the water again. How deep will the cylinder with the coin dip?*

- (a) *the height of an extending polystyrene is the same as the height of the coin*
- (b) *polystyrene will not extend from the surface since the coin pulls it to the bottom*
- (c) *the higher part of polystyrene than the coin will extend from the surface*

***Correct solution of physics learning task:*** (a) *This is about Archimedes' principle application. Weight of the cylinder does not change during turning and therefore buoyant force and volume of the sunken part of the cylinder will be the same.*



**Figure 4. Problem cylinder**

## 6.2 Physics learning tasks for gifted students - play physics learning tasks

We define a toy as an object which displays a feature that is remarkably emphasized (elasticity, colour, distinctive behaviour etc.). The toy in the role of hands-on activity stimulates the needs to have sense and muscle activities. The relaxation function of the play is also remarkable. There are many toys manufactured commercially but students can create their own. We can form the play learning task (to discover a principle of the toy etc.) and apply it to gifted students. An example of play physics learning tasks follows (Trna, 2007):

**Balance on a surface:** *We put a high block of polystyrene on the water surface in a vessel with its big sidewall. The block in a stable position is lying on the surface. Then we sink a load (screw, nut etc.) into the centre of a small base of the second block, same as the first one. If we put the second block with its big sidewall down on the water surface, it surprisingly stands up on its small base. Explain the base of the demonstrated phenomenon.*

**Correct solution of physics learning task:** *Surprising behaviour of the second block is caused by lowering of the centre of block mass thanks to the load.*

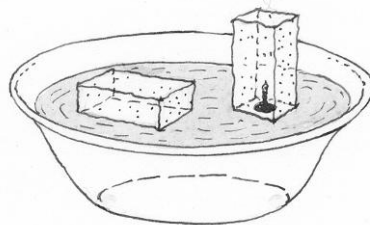


Figure 5. Balance on a surface

## 6.3 Physics learning tasks for gifted students - modification physics learning tasks

Strong motivation and support of creativity development is brought by physics learning tasks which contain creation of modifications. Students' learning task is to create similar experiment or, on the contrary, an experiment with additional physics phenomenon. These learning tasks are appropriate especially for gifted students to develop their creativity. An example of modification physics learning tasks follows (Trna, 2005):

**Buoyant hydrostatic force:** *Create experimental equipment for measuring of the buoyant hydrostatic force made from polystyrene.*

**Correct solution of physics learning task:** *The equipment is presented on the figure 6.*

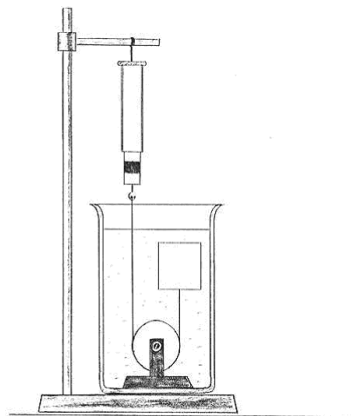


Figure 6. Buoyant hydrostatic force

## 7 Conclusions

Disabled and gifted students must be considered as learners with special educational needs in physics education. It is possible to assume that the individual educational development of every student will be a future imperative in physics education. Learning tasks are an important part of physics education also for students with special educational needs. Because of the quick increase of physics and science education efficiency, information about special educational needs must be inserted into both pre-service and in-service physics teacher training. Physics teacher has the crucial role in this innovation of educational technology. Physics teacher must be forearmed by wide professional spectrum of knowledge, methods, aids etc.

## 8 References

- Amatrang, T. (1998). *Awakening Genius in the Classroom*. Alexandria, VA, USA : Association for Supervising & Curriculum Development.
- Berlyne, D.E. (1997). Notes on Intrinsic Motivation and Intrinsic Reward in Relation to Instruction. In: Clarizio, H.F., Craig R.C., Hebrens, W.A. : *Contemporary Issues in Educational Psychology*. London.
- Biederman, J. (1998). "Attention-deficit/hyperactivity disorder: a life-span perspective". *The Journal of Clinical Psychiatry* 59 Supl. 7: 4–16.
- Dehaene, S. (1997). *The Number Sense: How the Mind Creates Mathematics* New York : Oxford University Press.
- Henderson, A., Came, F., and Brough, M. (2003). *Working with Dyscalculia*. Learning Works International Ltd.
- Talyzinova, N. F. (1988). *Utvareni poznovacich cinnosti zaku*. Praha : SPN.
- Tolingerova, D. (1970). Uvod do teorie a praxe programovane vyuky a vycviku. *Odborna vychova*, 21, p.77-78.
- Trna, J. (2008). Hands-on Activity as a Source of Motivational Effectiveness of Learning Tasks in Science Education. In *Hands-on Science 2008. Formal and Informal Science Education*. Braga : Univ. Braga. pp. 78-82.
- Trna, J. (2005). Motivation and Hands-on Experiments. In *HSci2005. Hands-on Science in a Changing Education*. Rethymno : University of Crete, pp. 169-174.
- Trna, J. (2007). Motivational Problem Exercises Based on Simple Experiments. In *Science and Technology Literacy in the 21st Century. Volume II*. Cyprus : University of Cyprus, pp. 15-24.
- Trna, J., Trnova, E. (2006). Cognitive Motivation in Science Teacher Training. In *Science and Technology Education for a Diverse World*. Lublin : M. Curie-Sklodovska university press, p. 491-498.
- Vaculova, I., Trna, J., Janik, T. (2008). Ucebni ulohy ve vyuce fyziky na 2. stupni zakladni skoly: vybrané výsledky CPV videostudie fyziky. *Pedagogicka orientace*, 8(4), pp. 59-79.

## Acknowledgements

The paper was created and supported within the project projects "Special Needs of Pupils in Context with Framework Educational Program for Primary Education"(MSM0021622443).

# Chapter 3

---

Topical Aspects

### 3.1 - History and Nature of Science

---

# CULTURAL CONTENT KNOWLEDGE – THE REQUIRED ENHANCEMENT FOR PHYSICS TEACHERS

Igal Galili

*The Hebrew University of Jerusalem*

*igal@vms.huji.ac.il*

## **Abstract**

Involvement of the History and Philosophy of Science is considered of making physics knowledge cultural. The materials produced within the HIPST project suggested historical excursions to some topics of school physics curriculum. They intend to upgrade teachers' knowledge of the subject matter. The concepts chosen to be addressed were of central importance for learning. We exemplify these units by two that address the concept of optical image and that of weight. Making knowledge cultural is defined and advocated as important.

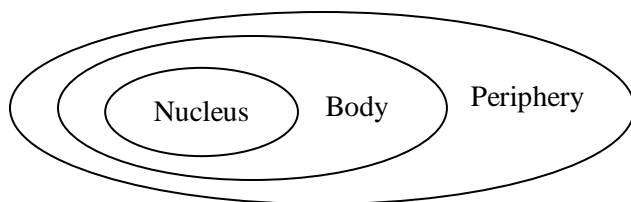
## **Introduction**

One may identify two tendencies in physics education. The first is the steep reduction of student population in physics classes. The second is prevailing orientation to problem solving, modeling and numerical account. The two tendencies can be related. Both demonstrate polarization of the educational system between professional occupation with science (the one which requires computational account) and the other dealing with qualitative account of Nature. The former matches the image of normal science (Kuhn's sense of "puzzles resolving"), whereas the latter represents the general interest to the world around, its account by physics concepts, ideas, and rules, in a way, approaching humanities and arts. The situation might resemble the prophecy of C.P. Snow (1962) regarding the Two Cultures as essential feature of our society.

Neither of these trends represents alone the entire nature of physics as a human endeavor. The conceptual, more holistic approach was the intention of the founders of physics who strived to reveal the regularity of the world and its organization and thus explain natural phenomena. This goal attracts wider population of students than we currently have in physics classes. Within this agenda the role of the history and philosophy of science (HPS) becomes central. It bridges between science and humanities. How exactly it could be done in pedagogically effective and physically meaningful way is not a trivial question. HIPST (History and Philosophy in Science Teaching) European project served us a framework to investigate the way which would not only involve HPS material but could essentially contribute to students' construction of the qualitative disciplinary knowledge of physics.

## **Background**

Facing the abundance of materials in physics curriculum, any teacher or learner needs a sort of hierarchical and functional structure of pertinent knowledge. Lacking such presents a major obstacle to the novice in physics. Tseitlin and Galili (2005) suggested a structure for a fundamental theory in physics that comprises three areas of knowledge elements (Fig. 1): nucleus, body and periphery.



**Figure 1.** The structure of a theory perceived as a culture

*Nucleus* incorporates the central principles – the paradigm of the theory, its fundamental principles and concepts of ontological and epistemological nature. The *body* incorporates various applications of the nucleus: solved problems, explained phenomena, algorithms for problem solving, phenomena explanations, experiments, apparatus and machinery and so on. *Periphery* incorporates all kinds of elements in opposition to the nucleus, its rivals from the past (old theoretical claims, concepts), present (alternative theories and learners' misconceptions) and future (the more advanced theories surpassed the claims of the nucleus).

Currently, the generic curriculum in physics is *disciplinary* restricted to the contents of nucleus and body. Adding periphery makes the knowledge in certain domain *cultural* and creates *discipline-culture* representing cultural content knowledge (CCK) (Galili, 2010). This approach was illustrated in a special course of optics for high schools (Galili & Hazan, 2004, 2009). Within the HIPST project, we also treated subjects of classical mechanics aiming to create CCK in this domain (HIPST, 2010).

To establish the required format we analyzed the discussions at our national meetings of physics teachers and considered the previous research experience of applying HPS materials (Matthews, 1994). It appeared to us that:

1. Physics teachers generally lack background knowledge both in history and philosophy of science. This should not surprise since teachers' training program and the standards of knowledge have no such requirements. Apparently, the situation in Israel repeats the one in Europe (Buchberger et al., 2000) and the US (AAPT, 1988). This is despite the claim of the *Benchmarks for Science Literacy* (AAAS, 1993) that the history of science should be included in science teaching.

2. The lack of background is often accompanied with the view that HPS are irrelevant and take students astray to wrong ideas, surpassed barriers, and obsolete problems, views not valid any more. This popular view among educators implies the need of those who design the HPS-based materials to demonstrate the relevancy of the suggested.

3. Finally, the teachers stated that the overloaded curriculum does not leave them any space to deviate from the material that is tested in the matriculate examination prevailed by problem solving and lacking aspects that would draw on the HPS. This orientation of the assessment rules out, in views of many, the HPS from physics classes. This view matches the pessimistic comment by Monk and Osborne (1997):

*... even materials produced for teachers, for example, those produced in the UK ... are not used. Attempts to produce restructured courses that put history at the center of the enterprise ... have enjoyed only marginal success ...*

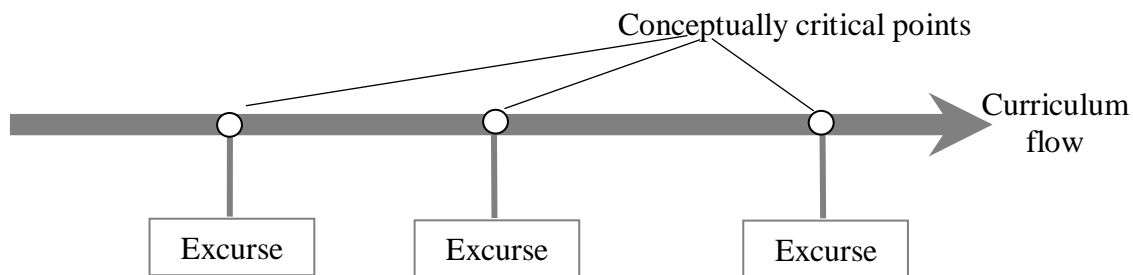
The same can be said about textbooks. Despite the renowned examples from the past (Mach, 1893; Taylor 1941, Rogers 1960, Rutherford et al., 1970) the contemporary

textbooks for schools and universities did not follow their course. Many HPS based materials are left in oblivion and the question *why* deserves an answer from those who continue to believe in the great potential of the HPS in physics education.

### **Excuse to the HPS as a suggested genre of making knowledge cultural**

In light of this background we understood that on our contribution to match the following constraints:

1. to display and comprehensively explain that the developed materials are relevant to the adopted curriculum;
2. to present, as far as possible, self-explained materials, in the sense of minimal contextual dependence on the external resources;
3. to preferably address the conceptually “critical points” (Viennot, 2004) of the curriculum (those determine students' success in general sense).



**Figure 2.** Schematic presentation of incorporation of historical excuse into curriculum.

We saw *historical excuse* to be an appropriate genre matching these constraints. Figure 2 may represent the idea of reinforcement of regular curriculum with provided excurses.

We appealed mainly to physics teachers helping in upgrading their knowledge of the aspects usually out of textbooks. After familiarizing with the contents of a particular excuse, the teacher will be in a position to integrate this knowledge to the way he or she presents the considered topic in his/her instruction. Thus, we suggested neither additional topic nor additional unit to be included in teaching. The change should be of quality rather than quantity matching the time constrain.

Our excurses included:

1. Description of the conceptual history of a certain concept;
2. Elaboration of historical and philosophical aspects of provided description, including aspects of the nature of science;
3. Elaboration on the relevance of the considered topic for the curriculum, including research evidence of students' difficulties and pertinent misconceptions.
4. Advises of activities and teaching method;
5. Short list of resources and further reading and expanding of the knowledge.



The produced modules aim to familiarize teachers with knowledge usually missed in their training although directly dealt with the subject. The scientific discourse displayed formation of the physical concepts and their introduction.

Addressing the historical discourse creates *diachronic dialogue* including contribution from different times, countries, worldviews, values, manners and norms of knowledge organization. And despite of all these differences these contributions created the *space of learning* (Marton *et al.*, 2004) essential for students understanding.

By its nature such a dialogue includes elements of knowledge obsolete and incorrect from the modern point of view. One may thus distinguish in physics history elements of two types. The elements of the first are often mentioned. They passed the "test of time" for their correctness. Such are the laws of lever, the buoyancy law (both by Archimedes), Pascal law of pressure in fluids, Eratosthenes measurement of the Earth radius, Aristarchus measurement of size and distance to the Moon, discovery of electron by Thomson. There are however other elements which are incorrect, in the modern view. Such are Aristotelian theory of motion, the medieval theory of impetus, Tycho Brahe's system of the world, Descartes' theory of motion, caloric theory of heat and Alhazen's theory of vision.

It is the latter type, however, that creates the cultural content knowledge (CCK), enlarging the space of learning. By this act the teacher presents the considered concept in its variation, which is the way to effectively and meaningfully learn it. In a way, one may say that ignoring the history of type I is *not* essential (it does not contrast concepts). However, ignoring the history of type II may indicate technical, superficial knowledge without mastering the genuine meaning of the concept.

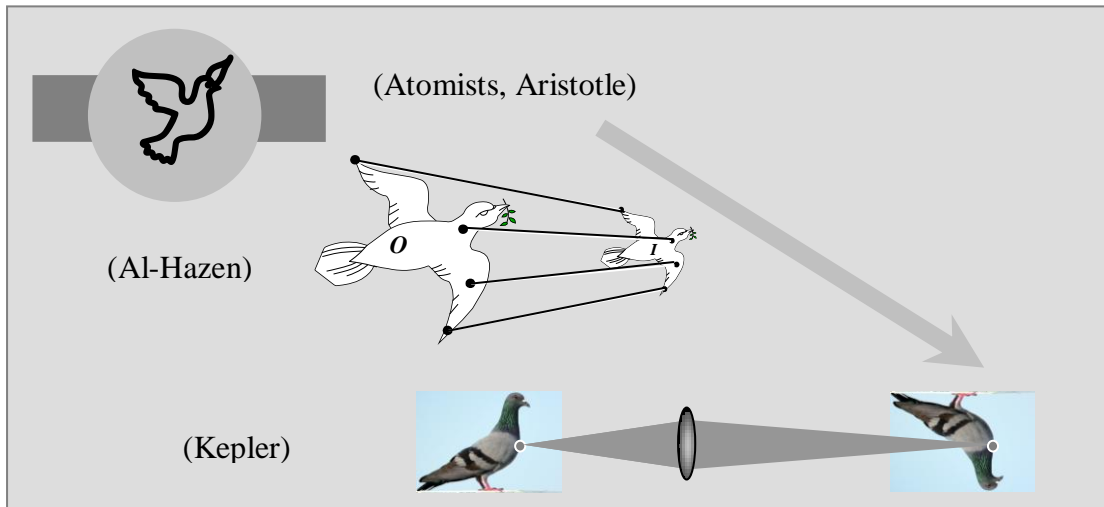
Excuse to the conceptual history of physics inevitably includes the type II history which belongs to the periphery of the discipline-culture structure (Fig. 1). We may say that excuse to the conceptual history replaces a formal concept by a *conceptual knot* – an inclusive construct incorporating various accounts, aspects and ideas suggested by the bright minds of the past while addressing the same issue.

## **Examples**

### ***Excuse to the history of optical image***

This excuse elaborates the genesis of physics knowledge regarding optical image and vision. Several theories were in use to account for optical image (Lindberg 1976). The excuse displayed the knowledge evolution from the Hellenic theories (Pythagorean active vision, Atomists' eidola, Plato's hybrid theory, and Aristotle's media stress), to the Hellenistic theory of Euclidean and Ptolemy's rays of vision, and the medieval theory of Al-Hazen (11<sup>th</sup> c). The story arrived to the theory of Kepler (17<sup>th</sup> c), currently taught at school – geometrical optics. Within the excuse, the history of light ray is traced from being the central concept of vision and light to an auxiliary concept in the wave theory.

In the debate between intromission and extramission theories, during more than two thousand years, the extramission theory was refuted by Al-Hazen in the 11<sup>th</sup> century and served as an intermediate stage before Kepler's account (Fig. 3, Table 1). The excuse utilizes art representations of image transfer and image transformation in a plane mirror.



**Figure 3.** Transformation of the model of image transfer (Corresponds to Table 1).

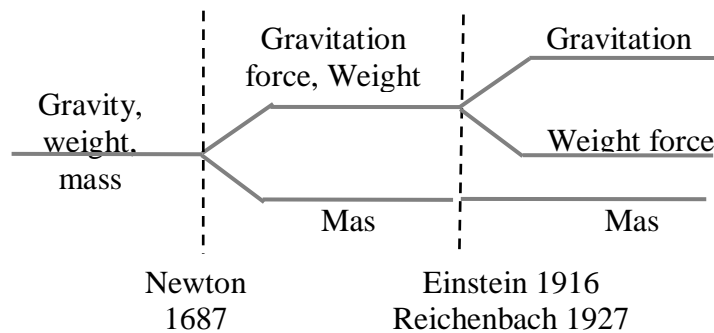
**Table 1.** Ontological changes in the intromission theory of optical image

Holistic <b>eidola</b> transfer into the eye of the observer (Atomists, Aristotle)	$\Rightarrow$	Points of an object are mapped to its image by single <b>rays</b> of light (Al-Hazen)	$\Rightarrow$	Points of an object are mapped to its image by light <b>flux</b> (Kepler)
---	---------------	--	---------------	--

Relevance of these contents for physics education follows several researches reporting about misconceptions that students held regarding vision and image creation and transfer (Galili & Hazan, 2000). The schemes of knowledge students hold show certain similarity to the conceptions of scientists in the past. Thus, pre-instructed students often show holistic understanding of image (similar to Atomists and Aristotle), whereas novice learners show the misconception of image transfer by means of a single ray per image point (Al-Hazen). It was checked experimentally that addressing the old theories of vision, in other words, cultural curriculum, has remedial effect on students' misconceptions (*ibid.*) and their views about the nature of science (Galili & Hazan, 2001).

### ***The excursion to the history of weight concept***

The excursion to the history of weight concept goes through the whole history of physics from its dawn to modern. In this conceptual knot of physics, weight can be presented as formed in three major steps: 1) weight is the characteristic feature *of the body* causing its heaviness and falling; 2) weight is the gravitational force acting on the body from another body and is different from mass, and 3) weight is the result of weighing the body, distinguished from the gravitational force (Fig. 4).



**Figure 4.** Conceptual evolution of the weight related concepts in physics history.

The definition of weight changed through the history showing complexity of the subject matter. Following genesis of the concept and corresponding epistemology the learner reveals the full picture, making the concept more meaningful due to variation in the appropriate *space of learning*. The story ultimately arrives to modern physics and the split between gravitation and weight (*operational definition* of weight) as implied from the principle of equivalence of Einstein (Reichenbach 1927/1958).

A special feature of this discourse is that this story continuous (Galili, 2001). One may see the split between the authors: those who keep with the Newtonian definition (e.g., Young & Freedman, 2004) – the majority in some countries, versus those who define weight operationally (e.g., Marion & Hornyack, 1982; Keller et al., 1993) – the majority in other countries. Seemingly, the cultural presentation comparing the approaches may lead to some consensus.

The excursion relates the ontological change (equivalence principle) with the epistemological change in physics in the 20<sup>th</sup> century, the introduction of the positivistic philosophy. Within this vision, Mach (1893/1989) performed revision of the classical mechanics, later extended by Bridgman (1927/1952) with the claim that the *operational definition* determines the meaning of any concept by means of measurement. The contemporary philosophy of science established a more mature requirement of two definitions: theoretical (nominal) and operational (epistemic) (Margenau, 1950). The issue is not new, neither in physics, nor in philosophy, but is still under debate in physics education.

The relevancy of the subject to physics teaching at different levels of instruction was reported in several studies (e.g., Galili & Kaplan, 1996; Galili & Lehavi, 2003; Gönen 2008). Appropriate discussion and new teaching may provide remedy to students' confusion. CCK of weight, by presenting the central role of measurement understood in physics, may lead to students' appreciation of the philosophy of science as the way which makes the scientific knowledge reliable and objective.

## Conclusion

We argued that physics knowledge of certain topic becomes cultural – cultural content knowledge –when it obtains a structure of discipline-culture. This way the history and philosophy of science is effectively introduced into physics curriculum. We have illustrated here the meaning of this conception by presenting modules on the topics of optical image and weight concept. Further empirical study is required to show that

adoption of these materials in teacher training can contribute to their professional competence and cause the change of the way they present the topics of conceptual importance in physics classes.

## References

- AAAS (American Association for Advancement of Science) (1993). *Benchmarks for Science Literacy. Project 2061*. Oxford University Press, NY.
- AAPT (American Association of Physics Teachers) (1990). *Course Content in High School Physics*. AAPT publication, College Park, MD.
- Arons, A. B. (1990). *A guide to introductory physics teaching*. Wiley, New York.
- Bridgman, P. W. (1927/1952). *The Nature of Some of Physical Concepts*. Philosophical Library, New York.
- Buchberger, F. Campos, B. P. Kallos, D. & Stephenson, J. (Eds.) (2000). *Green Paper on Teacher Education in Europe Thematic Network on Teacher Education in Europe*. Umeå Universitet, Umea, Sweden.
- Duit, R., Gropengießer, H., & Kattmann, U. (2005). Towards science education research that is relevant for improving practice: The model of educational reconstruction. In H.E. Fischer (Ed.), *Developing standards in research on science education* (pp. 1–9). London: Taylor & Francis.
- Galili & Hazan, (2004, 2009). *Theory of light and vision in broad cultural approach*. Parts 1-3. The Hebrew University of Jerusalem, Israel (In Hebrew).
- Galili, I. & Hazan, A. (2000). The influence of a historically oriented course on students' content knowledge in optics evaluated by means of facets - schemes analysis. *American Journal of Physics*, 68 (7), S3-15.
- Galili, I. & Hazan, A. (2001). The effect of a history-based course in optics on students views about science. *Science & Education*, 10 (1-2), 7-32.
- Galili, I. & Kaplan, D. (1996). Students Operation with the Concept of Weight. *Science Education*, 80(4), 457-487.
- Galili, I. & Lehavi, Y. (2003). The importance of weightlessness and tides in teaching gravitation. *American Journal of Physics*, 71(11), 1127-1135.
- Galili, I. (2001). Weight versus gravitational force: Historical and educational perspectives. *International Journal of Science Education*, 23, 1073–1093.
- Galili, I. (2010). History of Physics as a tool for teaching. In M. Vicentini & E. Sassi (eds.), *Connecting research in Physics Education with Teachers Education*. I.C.P.E. book, pp. 153-166.
- Gönen, S. (2008). A Study on Student Teachers' Misconceptions and Scientifically Acceptable Conceptions about Mass and Gravity. *Journal of Science Education and Technology*, 17, 70-81
- HIPST (2010). <http://hipstwiki.wetpaint.com>
- Keller, F. J., Gettys, W. E., & Skove, M. J. (1993). *Physics* (pp. 99-100). McGraw Hill, New York.
- Lindberg, D. (1976). *Theories of Vision Form Al-Kindi to Kepler*. The University of Chicago, Chicago.
- Mach, E. (1893/1989). *The Science of Mechanics*. The Open Court, La Salle, Illinois.
- Margenau, H. (1950). The role of definitions in science. In *The Nature of Physical Reality* (pp. 220-244). New York: McGraw-Hill.
- Marion, J. B. & Hornyack, W. F. (1982). *Physics for Science and Engineering*, Saunders New York, Vol. 1, p. 129.
- Marton, F., Runesson, U. & Tsui, A. B. M. (2004). The Space of Learning. In F. Marton, & A.B.M. Tsui (Eds.), *Classroom Discourse and the Space of Learning* (pp. 3-40). Mahwah, New Jersey: Lawrence Erlbaum.
- Matthews, M. (1994). *Science teaching: the role of history and philosophy of science*. New York: Routledge.
- Monk, M., & Osborne, J. (1997). Placing the history and philosophy of science on the curriculum: A model for the development of pedagogy. *Science Education*, 81(4), 405–424.

- Morrison, R. C. (1999). Weight and Gravity – The Need for Consistent Definition. *The Physics Teacher*, 37, 51-52,
- Reichenbach, H. (1927/1958). *The Philosophy of Space and Time* (p. 223). Dover, New York.
- Rogers, E.M. (1960). *Physics for Inquiring Mind*. Princeton University Press, Princeton, NJ.
- Rutherford, F.J., Holton, G. & Watson, F.G. (1970). *The Project Physics Course*. Holt, Rinehart, & Winston, NY.
- Snow, C.P. (1962). *The Two Cultures and the Scientific Revolution*. Cambridge University Press, Oxford.
- Taylor, L.W. (1941). *Physics. The Pioneer Science*. Dover, NY.
- Tseitlin, M. & Galili I. (2005). Teaching physics in looking for its self: from a physics-discipline to a physics-culture. *Science & Education*, 14 (3-5), 235-261.
- Viennot, L. (2004). Physics in Sequence: Physics in Pieces? In D. Grayson (Ed.), *What physics should we teach?* Proceedings of ICPE/SAIP, International Physics Education Conference (pp. 77-90). Durban, South Africa: University of Natal.
- Young, H. D. & Freedman, R. A. (2004). *University Physics* (pp. 459-460). Pearson, Addison Wesley, New York.

# Teaching physical concepts using the history of physics

Ivan S. Ruddock

Nonlinear Spectroscopy and Sensing  
Department of Physics, SUPA,  
University of Strathclyde  
Glasgow G4 0NG, UK

Tel: 0141-548-3268; Fax: 0141-552-2891; Email: i.s.ruddock@strath.ac.uk

## 1. Introduction

Physics graduates are valued for the generic or “soft skills” they have accumulated during their courses and their ability to see the links between disparate areas of science. Employers frequently rate these attributes more highly than specialist knowledge; but how do students see the “big picture”, or answer the question “how did we get to here from there?”, when they are being taught increasingly specialised material as their degree courses progress through the years?

An approach adopted in the University of Strathclyde is described in this paper, and is the basis of a level 4 class, *Physical Concepts*. In Scotland, higher education’s academic levels are in a range of 1 → 5 in line with the descriptors established and published by the Scottish Credit and Qualifications Framework (SCQF) [1]; 1 → 3 is equivalent to the Bologna Bachelor, 1 → 4 is the Scottish “honours” Bachelor and 1 → 5 is the Scottish integrated Master. *Physical Concepts* is compulsory for students of the honours BSc course in Physics with Teaching in which the Postgraduate Certificate in Education is awarded along with the degree and qualifies the graduate as a secondary school teacher. It has also proved to be a popular option for mainstream physics students. The aim of *Physical Concepts* is to track the development of key concepts in physics and review how this shapes the current understanding of the subject. At the end of the class, the intention is that students have a better appreciation of physics as an evolving subject rooted in practical usefulness but with a coherent and self-contained structure of concept and theory. *Physical Concepts* is an example of a “soft skills” class that is necessary to satisfy the SCQF’s requirements for a degree course and as well as the Core of Physics of the UK’s Institute of Physics which outlines the content of a course eligible for accreditation [2].

## 2. Concepts in physics

Public interest in relatively fundamental physics is frequently raised by the media, usually in response to either large amounts of funding being requested or spent, or by some potential hazard suddenly becoming topical; but if concepts are important, are they being addressed in undergraduate degree programmes? University courses and the school curriculum can lead to a piecemeal understanding of physics in which demonstrable competence in completing exercises disguises deficiencies in the understanding of basic concepts. The products of this system are comfortable with quantitative tests yet insecure with qualitative questions. When asked to explain something, students and even their teachers sometimes find it difficult to separate the “wood” (the underlying concepts) from the “trees” (the equations to perform the calculations). This view is echoed by Paul Hewitt, author of *Conceptual Physics*, who described being a physics student in an article in *Physics World*, the Institute of Physics members’ magazine: “*This was my experience as a student. In every physics course I took, the first two stages hardly existed (stage 1 – informal hands-on experience, stage 2 – explanations and definitions). There were no activities, very little time was spent on concept development, and we went directly to stage 3 – applications. It was problem solving from day*

*one. I was trained to solve problems based on concepts that I did not understand. I never developed a gut feel for concepts until graduate school, and these were not honed until I began teaching.” [3]*

Conceptual understanding, or the lack of, has been an issue in physics education for many years. The usual method to monitor the impact of teaching in a specific area is via analytical quantitative tools known as concept inventories. The first of these was the well known Force Concept Inventory pioneered by David Hestenes, Department of Physics and Astronomy, Arizona State University [4]. With *Physical Concepts* being designed for the BSc in Physics with Teaching, this issue is revisited in section 4. Conceptual understanding is also seriously tested in the undergraduate research project oral examination, the PhD viva-voce examination and certain types of job interviews. It is only fair to students that they have as much experience and practice in analysing and discussing fundamental ideas as possible.

### **3. History as a resource for physical concepts**

#### **(a) *How did we get to here?***

Physics has developed via the resolution of opposing theories, sometimes completely contradictory or mutually exclusive. In the “official” history of physics, established theories have been modified and overthrown as experimental evidence has emerged, frequently driven by improvements in instrumentation. This view of the development of physics provides the basis for a useful exercise – *How did we get to here?* – that attempts to identify the ways in which the subject has progressed. There are many possible choices of fundamental topic that emerged from two opposing theories, models or concepts. Examples include both the early corpuscular v wave theory of light debate (17th – 19th century) and the quantum era debate (19th – 20th century), the big bang v steady-state view of the universe, the existence of the ether, the infinite v finite speed of light, the heliocentric v geocentric models of the solar system, thermal radiation and early quantum theory, and the ages of the Sun and Earth. In performing this exercise, students write a paper and give a presentation describing, where appropriate, the physics, the evidence on both sides of the debate, the main protagonists and their roles, and what finally decided the outcome of the argument.

#### **(b) *Infamous predictions***

“*Prediction is very difficult, especially about the future*” is a well known quotation variously attributed to Niels Bohr and others. Everyone is tempted into making rash predictions on the basis of existing knowledge, and depending on the reputation of the individual, these are remembered and quoted when proven to be incorrect. The analysis of the original justification for a specific prediction provides the basis for a novel exercise in linking together disparate areas of physics. For example, Thomas Edison [5]: “*Fooling around with alternating current is just a waste of time. Nobody will use it, ever.*” This quotation leads to the promoters of D.C. and A.C. current (Edison v George Westinghouse and Nikola Tesla), the opposing arguments in the 19th century “current wars”, the physics of the advantages and disadvantages behind D.C. and A.C. power transmission and voltage control, the development of D.C. and A.C. electrical machines - the induction motor in particular, the perceived relative risks of D.C. and A.C. power, and 21<sup>st</sup> century applications of D.C. such as short distance power transmission and railway traction. Similarly, “*.....so far as astronomy is concerned, we must confess that we do appear to be fast approaching the limits of our knowledge*” from Simon Newcomb, Canadian-born American astronomer in 1888 [6], challenges students to identify what was known in 1888, what technical developments since then have enabled new facts and theories to be established (radio and X-ray astronomy etc), and what important observations have been made since 1888 (nebulae being external galaxies, expansion of the universe etc.).

Unfortunately, some well known quotations are wrongly recorded, attributed, or just confused, although they remain valid for the purposes of a student exercise. For example: “*There is nothing new to be discovered in physics now. All that remains is more and more precise measurement.*” This is frequently linked to Sir William Thomson (Figure 1), Lord Kelvin from 1892 in partial recognition of his efforts in helping to defeat Gladstone’s Irish Home Rule Bill of 1886 [7]. However, this appears to have arisen from a comment by Michelson when he was justifying the need for greater precision in interferometry and spectroscopy [8] in which he mentions the views of someone else, probably Kelvin: “*The more important fundamental laws and facts of physical science have all been discovered, and these are so firmly established that the possibility of their ever being supplanted in consequence of new discoveries is exceedingly remote. Nevertheless, it has been found that there are apparent exceptions to most of these laws, and this is particularly true when the observations are pushed to a limit..... Such examination almost surely leads, not to the overthrow of the law, but to the discovery of other facts and laws whose action produces the apparent exceptions..... Many (other) instances might be cited, but these will suffice to justify the statement that ‘our future discoveries must be looked for in the sixth place of decimals.’*” Although he referred specifically to the isolation of argon by Rayleigh and Ramsay in 1894, in the last sentence he clearly pointed to Kelvin who had recently written: “*I often say that when you can measure what you are speaking about, and express it in numbers, you know something about it; but when you cannot express it in numbers, your knowledge is of a meagre and unsatisfactory kind; it may be the beginning of knowledge, but you have scarcely, in your thoughts, advanced to the stage of science, whatever the matter may be.*” [9,10]

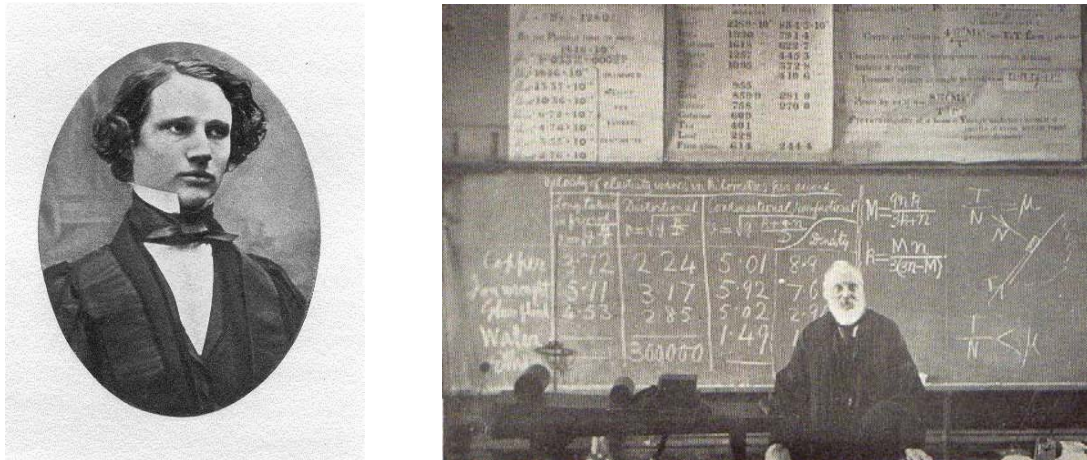


Figure 1. Left: William Thomson aged 22 in 1846, the year he was appointed to the chair of natural philosophy in Glasgow. (Photograph from A. Gray, *Lord Kelvin: An account of his scientific life and work*, London: Dent (1908).) Right: Lord Kelvin aged 75 at his last lecture in 1899, the year he retired from the same post. (Photograph from S.P. Thompson, *The life of William Thomson, Baron Kelvin of Largs*, London: Macmillan (1910).) During his long career, in which he wrote extensively, gave countless public lectures and made numerous speeches, he naturally provided many examples of unfortunate predictions.

Due to Kelvin’s fame, which dated from his contribution to the success of the Atlantic telegraph cable in the 1860s, nearly every public utterance he made was recorded. He could almost be regarded as a one-man resource because with the benefit of hindsight, some of his predictions inevitably proved to have been unwise; for example: “heavier than air flying



machines are impossible”, “X-rays will prove to be a hoax”, or “radio has no future”. Indeed, it might have been Kelvin that Arthur C. Clarke was thinking of when he wrote: "*If a distinguished but elderly scientist states that something is possible, he is almost certainly right. When he states that it is impossible, he is very probably wrong.*" [11]

#### **4. *Physical Concepts at the University of Strathclyde***

The class, *Physical Concepts*, normally has a weekly one hour meeting during a twelve week semester with extra time allocated for presentations. The usual format of each meeting is for the lecturer to give an introductory talk which is then followed by brainstorming and group discussion. Each session finishes by reporting back from the groups and notification of the next assignment which is frequently based on the theme of the meeting. The class is assessed by essays and oral presentations including peer assessment of the latter.

Some of the tasks undertaken by *Physical Concepts* students have already been outlined above in Section 3, but there are additional activities in which they are exposed to concepts in physics. In detail, these are:

1. *What is physics?:-* From Wikipedia’s History of Physics or similar, each student chooses a development which he/she considers to be a major breakthrough in physics. A short paper is written that briefly describes the physics of the development, explains its importance, sets it in context historically, identifies its relationship with other areas of physics and highlights any subsequent applications and implications. A 3 minute summary of the topic is then delivered without visual aids or notes. This serves as an icebreaker and helps students become familiar with speaking in front of each other.
2. *Conceptual testing:-* Groups of students devise simple multiple choice questions to test conceptual understanding of a topic on basic physics such as classical mechanics and DC circuits.
3. *Demonstrating physical concepts:-* Groups of students examine in turn sets of physics demonstration apparatus or toys such as the simple pendulum, Cartesian divers, the fine beam tube and “lunar basketball” (ExecuToys Space Game) [12]. They attempt to identify the basic physics that the apparatus is demonstrating – in each case there are many different principles involved – and then report back with each group offering one for each apparatus in turn until all their ideas are exhausted. In the case of the fine beam tube for example, there is thermionic emission, electrostatic force and acceleration, transverse magnetic force, centripetal force and acceleration, energy transfer to residual gas, relaxation and emission of fluorescence. Each of these topics can be drilled down further to yield even more fundamental physics.
4. *Explaining physical concepts:-* This activity was specifically included for the benefit of the Physics with Teaching students. Topics are selected from the Scottish Qualifications Authority’s syllabus for the Advanced Higher Physics examination taken in the final year in school [13]. For each chosen topic, a paper and presentation are prepared clearly explaining the concepts involved in the appropriate Content Statement, identifying a strategy by which it can be introduced and answering some “awkward questions” that might be posed by a school pupil. For example, the Content Statement for Moment of Inertia (Advanced Higher Unit 1, Section 1.3 Rotational dynamics) is “*Explain that the moment of inertia of an object depends on the mass of the object and the distribution of the mass about a fixed axis. State that in the absence of external torques, the angular momentum of a rigid object is conserved. State that the rotational kinetic energy of a rigid body depends on its moment of inertia and angular velocity.*” The corresponding awkward questions that the student is expected to address could be (i) *a flywheel has the mass concentrated near the rim but a discus used in athletics has it at the centre – is this*

- anything to do with moment of inertia?, (ii) what about the small weights on the rim of a car's wheel – what are they for?, (iii) has any of this topic to do with riding a bicycle?
5. *Physical concepts in the public domain*:- Students identify which concepts in physics, or with an underlying physics basis, are currently important issues as far as the general public, media and government are concerned. Examples recently considered include the Large Hadron Collider and the Higgs boson, the safety of electric power cables, storage of nuclear waste, the return to the moon, high speed rail travel, asteroids, energy – wind, solar, biomass.
  6. *Incorrect explanations and analogies*:- There are many cases in physics where the established explanation or analogy given in textbooks has been incorrect for decades. One such incorrect explanation concerns single-mode optical fibres. Virtually every textbook in optics and fibres published in the past 30 or more years contains a statement such as: “When the fibre is thin enough so that only one mode (a ray in the axial direction) satisfies this condition, the fibre is said to be single-mode” [14] or “The axial mode propagates a given fibre length in the least time” [15]. The underlying issue with this approach to explaining modes and modal dispersion is that there is no such concept as an axial ray in an optical fibre [16]. This author has only identified one textbook containing a diagram showing the correct zigzag path for the ray in a single-mode fibre [17]. An example of an incorrect analogy, this time in most elementary textbooks, is in polarised light where the action of crossed polarisers on light is frequently compared to that of crossed picket gates on a vibrating rope or similar [18]. While this serves to demonstrate light extinction, it does not assist with the understanding of how a polariser works or what happens when a third polariser is placed at 45° between them. There are many websites [19] dealing with misconceptions in physics, criticism of textbooks and pseudoscience which are great resources for exercises of this kind.

## 5. Conclusions

An undergraduate class focusing on the development of concepts in physics and how they shape current understanding has been outlined. In it, students gain an appreciation of concepts and their linkages by examining the contributions of important individuals, by their testing and experimental demonstration, by explaining selected examples in the secondary school syllabus and by analysing concepts underlying current issues in the public domain. The class also provides extensive experience of group discussion, essay writing and presentations.

## 6. References

- [1] The Scottish Credit and Qualifications Framework (SCQF), [www.scqf.org.uk](http://www.scqf.org.uk).
- [2] The Institute of Physics, [www.iop.org](http://www.iop.org).
- [3] Physics World, pp. 16-17, September 2004.
- [4] D. Hestenes, M. Wells and G. Swackhamer, *The Physics Teacher* **30**, 141 (1992).
- [5] C. Cerf and V.S. Navasky, *The Experts Speak: The Definitive Compendium of Authoritative Misinformation*, New York: Villard (1998).
- [6] S. Newcomb, *The Sidereal Messenger*, **7** 69 (1888).
- [7] C. Smith and N.W. Wise, *Energy and Empire*, Cambridge: Cambridge University Press (1989), pp. 802-811.
- [8] A.A. Michelson, *Light Waves and their Uses*, Chicago: University of Chicago Press (1903), pp. 23-24.
- [9] Sir William Thomson, *Electrical Units Of Measurement, Popular Lectures and Addresses*, London: Macmillan (1889), vol. 1 p. 73.
- [10] *Oxford Dictionary of Quotations*, 4<sup>th</sup> edition, Oxford: Oxford University Press (1992).
- [11] A.C. Clarke, *Profiles of the Future: An Inquiry into the Limits of the Possible*, London: Gollancz (1962), p. 25.
- [12] Available from many online retailers (October 2010).
- [13] The Scottish Qualifications Authority (SQA), [www.sqa.org.uk](http://www.sqa.org.uk).

- [14] F.L. Pedrotti, L.M. Pedrotti and L.S. Pedrotti, *Introduction to Optics*, 3<sup>rd</sup> edition, Upper Saddle River, NJ: Pearson Prentice-Hall International (2007), section 10.4 on p. 249 and figure 10.9, p. 254.
- [15] C.A. Bennett, *Principles of Physical Optics*, Hoboken, NJ: Wiley (2007), figure 4.38, p. 170.
- [16] I.S. Ruddock, *Eur. J. Phys.* **30** 303 (2009).
- [17] R.G. Seippel, *Optoelectronics*, Reston, Va: Reston Publishing Co. (1981), figure 7.11, p. 155.
- [18] See for example: P.G. Hewitt, *Conceptual Physics*, 8<sup>th</sup> edition, Reading, Mass: Addison-Wesley (1998), figure 28.31, p. 531.
- [19] At the time of writing (October 2010), the following websites are large resources for discussion of pseudoscience, misconceptions in physics and criticism of textbooks:  
<http://www.lhup.edu/~dsimanek/home.htm>,  
<http://www.eskimo.com/~billb/miscon/miscon4.html>

# **Approaching the concept of atmospheric pressure : an interview based on Torricelli's barometer.**

Pascal SAUVAGE, Cécile de HOSSON  
Laboratoire André Revuz, Université Paris Diderot - Paris 7

## **Abstract**

The ambition of our study is to highlight spontaneous reasoning involved in hydrostatic problems and to identify key steps in students' learning processes that could be useful for teaching hydrostatics. More specifically, this article aims at observing and modifying the spontaneous reasonings involved in the interpretation of Torricelli's experiment (the mercury barometer). Our study consists of three forty-minute interviews during which several experiments are either performed or presented to a student. The sequence of experiments has been designed by taking into account the History of Sciences, especially regarding the role of the atmospheric pressure. The analysis of the interviews confirms a marked tendency towards localized reasoning established in previous research, while clarifying its nature : according to the students, the test-tube mercury either floats on that of the container or is drawn upwards by the effect of capillarity. Our study also modulates previous research about the concept of vacuum, both in itself, and applied to Torricelli's experiment and suction pumps: whereas they consider that this vacuum cannot physically exist, they spontaneously use the concept to interpret and predict the phenomenon of suction. Also, the students retain a notion of “vacuum” corresponding to a total absence of matter. The interview designed and carried out for the experiment aims not only to observe students' difficulties, but also to modify them. For two of the three students, the sequence does indeed contribute to an understanding of the significance of the role played by the air surrounding the tube. This study is also an interesting example of the role that History of Science can play for Teaching Sciences in *anticipating* reasoning strategies or difficulties on one hand and *providing ideas* to modify reasoning on the other.

## **Introduction**

The ambition of our study is to highlight spontaneous reasonings involved in hydrostatic problems and to identify students' key learning steps, in order to contribute to the understanding of problems involved in teaching hydrostatics. In order to do this we chose a problem which is both classic and rich: Torricelli's experiment.

Torricelli's barometer experiment consists of a one-meter glass tube filled with mercury, stood upside-down in an unsealed container also filled with mercury. This experiment is a common illustration of the hydrostatic equation  $\Delta P = - \rho g \Delta h$ . However, as is the case in most of the other problem of hydrostatics, several of its more complex physical characteristics are masked by the mathematical simplicity of this equation.

The aim of this study is firstly to observe students' strategies in their interpretation of Torricelli's experiment. Given previous research results which strongly suggest that students fail to understand the experiment from a systemic point of view, we aim to identify more closely their localized reasoning. Secondly, we aim to develop a strategy which will allow teachers to modify their students' reasoning, leading them towards a systemic point of view.

Three individual interviews were carried out. They consisted of several experiments which were either presented to the students or performed in front of them. The sequence of experiments

was designed by considering not only previous research about students' spontaneous reasoning concerning Torricelli's experiment, but also the historical development of the question, and of scientists' responses.

### **Historical guideline**

Ancient Greek scientists considered the phenomenon of suction to be a consequence of the Aristotelian doctrine, 'Nature abhors a vacuum'. However Galileo reported, in *Two new sciences* (1638), that a suction pump could not lift water more than about 10 meters.

In 1644, Evangelista Torricelli transformed the technical problem of the water-pumps into a scientific question by proposing a new experiment using mercury. Torricelli suggested two new hypotheses : firstly, that the space above the mercury is a vacuum; secondly, that air has mass. These hypotheses led to the interpretation that it is the weight of the air outside, pushing on the mercury in the container, which maintains the height of the column.

Each of Torricelli's two assumptions raised controversies among the scientific community and several experiments were designed to assess them. These consisted in modifying the environment of Torricelli's device: in Pascal's experiment (1648), it is placed at different heights in the atmosphere [1]; in Boyle's experiment (1660), it is performed in a suction device [2]; in Mariotte's experiment (1676), it is placed at different depths in water [3]. It is the explicit analogy between water and air established in Mariotte's experiment which definitively confirms Torricelli's interpretation.

### **Research background**

Several studies analyse students' reasoning concerning aspects of the experiment. The unifying concept of "fluid" doesn't always seem to be operational for students: although most rightly assert that pressure increases with depth in liquids [4], some incorrectly think that atmospheric pressure increases with altitude [5]. However, some difficulties arise which apply both to liquids and gases: the pressure in a fluid is usually confused with the forces exerted by the fluid [4]; pressure is often associated with the volume of fluid surrounding an immersed solid, and not only with depth (or altitude) [6], and its effects are widely seen as directional (usually down) [7, 4, 8]. "Vacuum" is another problematic concept for students. While a high percentage of young people struggle to admit the existence of an absolute vacuum [9], any degree of "vacuum" is commonly considered to have mechanical properties, most importantly, that of aspiration [10, 11].

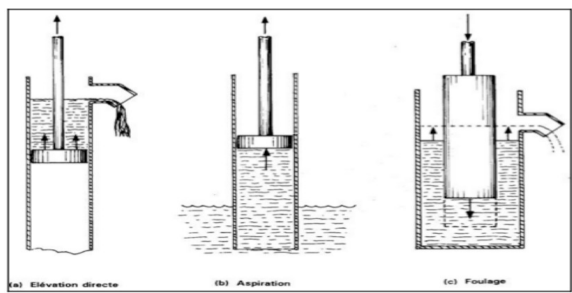
Elements of the History of Science can be useful for anticipating students' difficulties and providing ideas for teaching sciences. In 2009, Hosson & Caillarec [12] used Pascal's experiment to study students' understanding of Torricelli's experiment. They asked the students why the height of the column of mercury changed at different altitudes. Over three-quarters of the 128 students surveyed did not explicitly take the air outside the device into account in their explanation. Indeed, instead of using a systemic point of view, they tended to use localized reasonings, based on the following elements of the experiment: the content of the space above the mercury, which, according to the students, would dilate or contract; the column of mercury which would dilate or contract, like in a thermometer; and the mercury in the container which would support the mercury in the tube. In the end, as was the case for scientists in the 17<sup>th</sup> century, the study found that Pascal's experiment alone was not sufficient to convince students of the mechanical influence of the air.

Hence, two questions emerged: firstly, how to confirm and complete these results, and secondly, how to lead students to take into account the mechanical effect of air. Like the previous study, ours will be based on a framework drawn from the History of Science: this time, using Boyle's experiment to illustrate and clarify Torricelli's experiment to students.

### **The interview**

An interview was designed based on a series of experiments, either performed or presented to the student. This series was conceived to distinguish the relevant variables (density of the liquid,

maximum height of the column of liquid, outside air) from the non-relevant ones (length of the tube, size of the container), and to demonstrate the relationships between the relevant variables. The series of experiments presented to the three students were identical, as was the process used to elicit responses at each step. This process consisted of a first stage, designed to identify students' spontaneous responses, in which an experiment was set up and they were asked Q1) to predict its results, and Q2) to explain their prediction. The experiment was then performed, and a second set of questions was asked, aiming to lead them to modify their spontaneous reasoning: Q3) to observe the experiment, Q4) to compare their observation to their prediction, and Q5) to interpret this comparison.



The question to be resolved during the interview is presented at the beginning. Three different types of pumps are presented and it is stated that it is impossible for the second one, a suction pump, to raise water above a certain height (which is not given at this stage). The student is then asked why; all the following experiments are designed to develop a systemic understanding of this phenomenon.



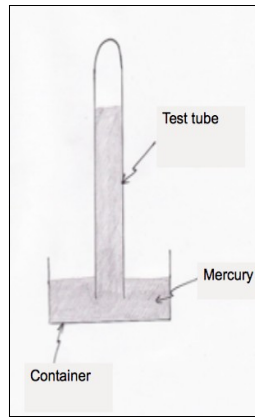
First, the suction pump is illustrated experimentally using a syringe. The student is asked the series of questions Q1-Q5, beginning with Q1 : “What will happen if the syringe piston is pulled?”



Torricelli's experiment is then presented, using water instead of mercury. The key Q1 is : “What happens if the tube filled with water is stood upside-down in a container of water?”

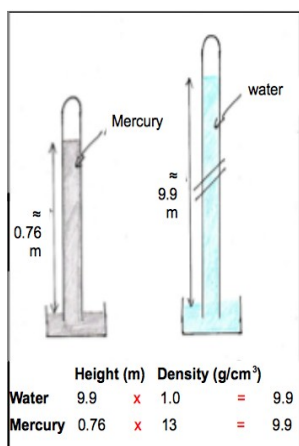


The student is asked what will happen if the tube is stood upside-down in a much smaller container. The following Q1 is: “What will happen if the experiment is performed with longer and longer tubes?” The answer is not given at this stage.

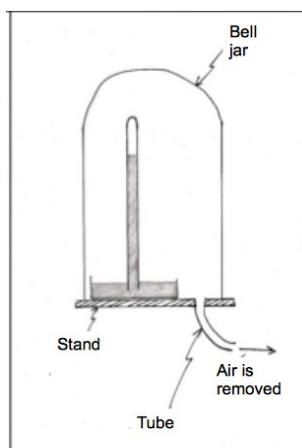


The following step asks the student to predict the result if the water is replaced with mercury. After the presentation of the actual observation the student is asked: “What is above the mercury?”

The following stage asks the student to combine his previous findings to make a new prediction. The diagram of Torricelli's original experiment, using mercury, suggests the following Q1 : “Do you think that, as for the mercury, the column of water will stop at a maximum height?” The student is asked whether the column of water is taller or less tall than the column of mercury.



The final experimental step concerns the influence of modifications of the air pressure (Boyle's experiment). Q1: "What will happen if there is more / less air inside the bell jar?"



This qualitative approach is followed by a quantitative complement in which the influence of the air is highlighted thanks to a simple calculation inspired by the hydrostatic equation; the student is asked what physical element could be the same in both experiments.

In the last step, we come back to the initial questions. The first of these was : "What is the height limit for suction pumps?" ; the second was "How can the limitation of the suction-pumps be explained?"

The interview was carried out with three students. Having based the outline of the interview on anticipated errors drawn from previous studies, most importantly those of Hosson & Caillarec [12], we selected students of the same level in order to remain coherent with these results. The three students are third-year University students of primary teaching. They all studied the concept of pressure in upper secondary school and hydrostatic laws during their first year of university.

## Results and discussion

A first series of results confirms previous results established by Hosson & Caillarec [12]: As in their previous research, none of the students surveyed here spontaneously mentioned the effect of the air outside the device; they also preferred local reasoning to a systemic approach. More specifically, during Boyle's experiment, we confirmed that students explained the phenomenon by suggesting a dilation / contraction of the column of mercury or of the matter in the space above the column.

Our study focussed on identifying different forms of local reasoning:

- As regards interpretations centred on the column of mercury, one of the students explained that water rises higher than mercury because the "*cohesive force*" between glass and water is stronger than that between glass and mercury. This interpretation brings to light a confusion between Torricelli's experiment and the notion of capillarity.

- With regard to the explanations centred on the mercury in the container, two students considered that as the liquids in the tube and the container are the same, their density is the same, and thus the column of mercury does not sink. This interpretation highlights a confusion between Torricelli's experiment and Archimedes' principle.

- Moreover, all three students predicted that the water inside the tube would overflow when the tube was stood upside-down in a much smaller container. This prediction reveals a misunderstanding of the role of the liquid in the container, probably due to a confusion between the properties of static liquid and those of solid matter.

This series of results highlights students' willingness to refer to different phenomena of fluid mechanics, (including Archimedes' law), whose limits, however, they do not perceive clearly. They are heavily influenced by their prior knowledge – even when it is imperfectly understood – and attempt to use known patterns in order to interpret an unfamiliar phenomenon.



Another series of results modulates previous research about the concept of vacuum, both in itself, and applied to Torricelli's experiment:

- Previous research suggests that students struggle to admit the existence of an absolute vacuum [9]. Our research confirms this idea and attempts to identify the nature and origins of this difficulty. We thus asked them to define a vacuum; the three students responded that "*a vacuum is when there is nothing*". This conception is inconsistent with the scientific point of view. Indeed, for example, the space above the column of mercury - usually qualified as *a vacuum* - is actually mercury gas whose particle density is around  $10^{13}$  atoms/cm<sup>3</sup> - extremely dense compared to the "vacuum" in a particle accelerator, where the particle density is around  $10^7$  molecules/cm<sup>3</sup>. It seems that students do not grasp the concept of partial vacuum, but represent it as a total absence of matter.

- Studies concerning younger students found that properties such as suction were attributed to vacuums [8]. While this was not precisely repeated in our study, we did notice that students spontaneously used the concept of a vacuum to justify the suspension of the column of liquid when there is no space above: in the case of the syringe, one of the students explained that "*when the piston is pulled, an empty space is created, but it is instantaneously filled with water*". Surprisingly, however, when an empty space actually *is* observed in Torricelli's experiment with mercury, it was hard for the three students to admit that was a vacuum. In the end, whereas for the Greek scientists 'Nature abhors a vacuum', it seems that for the students, 'Nature *forbids* vacuum' : it is an "impossibility" which physical systems must "work" to avoid. The concept is seen as artificial, although students admit that it allows the prediction of correct results.

This study also suggests that a "teaching interview" like this one, drawing on the History of Science for its design, could also be an effective tool for leading students to modify their initial responses. Whereas before the presentation of Boyle's experiment, the three students used local reasoning to interpret Torricelli's experiment, after Boyle's experiment, two of the three students were finally able to apply a systemic point of view: "*If there is more air inside the bell, the pressure will increase; thus, the air will push on the surface of the liquid in the container and the liquid will be pushed up inside the tube*". The third student, while concluding that air must play some role, was not able to interpret rightly Torricelli's experiment.

This discrepancy between the first two students and the third merits further analysis. Indeed, these first results suggest that there may be a parallel between scientific developments in the 17<sup>th</sup> century and students' approaches. Indeed, in both cases, there seem to be pre-existing conditions (correct understanding of the nature of vacuum, ability to apply a mechanical approach) to the understanding of Torricelli's experiment. This hypothesis will require further examination, either by a more specific analysis of the interviews already conducted, or by a survey of a greater number of students.

## **Conclusions and perspectives**

Our study provides several interesting analyses of spontaneous reasoning that could be useful for teaching not only Torricelli's barometer, but also hydrodynamics:

- in order to interpret Torricelli's experiment, the students used spontaneous reasoning inspired by their previous academic knowledge. Although this is a common and a productive learning strategy, it also causes misunderstandings. In terms of teaching, this suggests that in order to explain how Torricelli's experiment works, it could be useful to clarify why it is neither an example of floating or of capillarity. More generally, it suggests that the comprehension of a phenomenon could perhaps be aided by a comparison with others which produce similar results, but are based on fundamentally different principles.

- As the concepts of vacuum and suction occur frequently in studies of hydrodynamics, it is important to be aware of the fact that these notions often remain difficult for students. Two main ideas emerge. Firstly, students are ill equipped to accept the idea of a partial vacuum. Secondly, the



notion of “suction” remains, suggesting to students that a vacuum “pulls” fluids, rather than a more correct interpretation in which it simply “pushes” less than its environment. This seems to suggest that an approach to hydrodynamics would benefit from a better understanding of the vacuum.

Concerning the effects of the interview, we show that the designed series of experiments decisively modify the spontaneous reasoning of two of the three students, leading them to adopt a systemic point of view. Hence two questions emerge: why is Boyle's experiment decisive for one student and not for the other? Could there be a relationship with the effects of Boyle's experiment on the 17<sup>th</sup> century scientific community?

A detailed comparison between each step of the three interviews and a specific study of the historical context of Boyle's experiment should allow us to answer these questions soon.

## References

- [1] PASCAL, B., *The Physical Treatises*, (Columbia University Press, New York, 1937).
- [2] BOYLE, R., *New experiments physico-mechanical touching the spring of the air and its effects*, (London, 1660).
- [3] MARIOTTE, E., *Nature of air*, A Source Book in Physics (McGraw-Hill, New York, 1953).
- [4] KARIOTOGLOU, P. & PSILLOS, D., *Pupils' pressure models and their implication for instruction*, Research in science and technological education **11**, 95-108 (1993).
- [5] TYTLER Tytler, R. T., *Students' conceptions of air pressure: Exploring the nature of conceptual change*, International journal of science education **20**, 929-958 (1998).
- [6] VIENNOT, L., *Teaching physics*, (Springer, USA, 2003).
- [7] ENGEL CLOUGH, E. & DRIVER, R., *What do children understand about pressure in fluids?*, Research in science and technological education **3**, 133-144 (1985).
- [8] SMITH, P. S. & FORD, B. A., Project Earth Science: Meteorology, Arlington, VA: National science teacher association (1996).
- [9] NUSSBAUM, J., *The particulate nature of matter in the gaseous phase*, in R. Driver, E. Guesne & A. Tiberghien (eds.) Children's ideas in science, (Open University Press, London, 1985), 124-144.
- [10] SÉRÉ, M. G., *The Gaseous State* in R. Driver, E. Guesne & A. Tiberghien (eds.) Children's ideas in science, (Open University Press, London, 1985), 105-123.
- [11] DE BERGE, K. C., *Students' thinking in relation to pressure-volume changes of a fixed amount of air: The semiquantitative context*, International journal of science education **14**, 295-303 (1992).
- [12] de HOSSON C. & CAILLAREC B. (2009). Students' ideas about Blaise Pascal experiment at the Puy de Dôme Mountain. *Latin American Journal of Physics Education*. 3 [2], 207-213.

# The History of Physics as Part of the History of Culture

Dorothy Sebestyen  
Obuda University, Budapest, Hungary  
[sebestyen.dora@kvk.uni-obuda.hu](mailto:sebestyen.dora@kvk.uni-obuda.hu)

## Abstract:

*The course which I intend to present here is The Cultural History of Physics. At our university this is an optional course for the students of electrical engineering, following the compulsory, two-semester Physics course.*

*Studying the history of physics can contribute to deepening the students' understanding of physics, which has fundamental importance in the course of their studies and on the other hand it provides an opportunity for wide-ranging cultural educational lectures.*

*The first part of this paper intends to introduce this subject briefly. In the second part, examples of testing the students' knowledge will be presented. It will be highlighted how distance learners can be inspired to use the coursebook, or the Internet at home.*

## I. Introduction

Peculiar sequences of thought can be called into action by discovering the fact that Galileo, Kepler, Rubens, Descartes and Shakespeare were contemporaries. Although these personalities were far from one another in space and activity, they can get on well together side by side in the course of history of physics which is embedded in the general history of culture. I consider it especially important assignment that nowadays, when an incredible amount of information hits our students, we should show them orientation points of general culture. So we could arouse their intellectual interests in addition to their knowledge of profession.

Seeing that the character of this subject is essentially different from Physics, it seems to be an important question, how the students' knowledge, especially the knowledge of the distance learners can be evaluated.

## II. The structure of the subject of "The Cultural History of Physics"

The history of physics is always a subjective course, but in this case it has a *special* subjectivity: because in this one semester long course we try to *complement* a compulsory introductory physics course. In case of the topics which were discussed before in physics, we do not touch upon the physical laws in detail, instead of this, description of the characters of the physicists, of their connections, and of their contemporaries is given, their interests are mentioned or their thoughts are quoted.

### The chapters of "The Cultural History of Physics" course:

- Ancient physical and technical results
- Interests in mathematics and physics in the Middle Ages
- Relationship between art and optics in the 15th - 17th centuries
- Geniuses of the classical and „the celestial” mechanics in the 16th-17th centuries
- Discoveries in the field of electromagnetic phenomena in the 17th-19th centuries
- From the nature of heat to the heat engines of the 19th century
- The “classical” models of atomic structure
- Leading characters of special relativity and quantum mechanics
- History and fundamental phenomena of acoustics using a computer program
- Interests in the history of condensed matters from the discoveries to the applications
- History of nucleus from radioactivity to the use of nuclear energy
- Historical overview of the fundamental particles and interactions
- Hungarians in the history of physics

### III. Chronological tables

To characterize the course I would like to highlight the role of the chronological tables extended to some famous contemporaries from the other areas of culture.

At the beginning of each chapter a chronological table is presented about the actual period. These tables show the physicists' portraits, the time of their births, length of their lives, the main points of their activity and their contemporaries (painters, writers, composers, besides other physicists). Of course the possibility of the selection is very limited and subjective. Here we can see an example of these tables. (Figure 1)

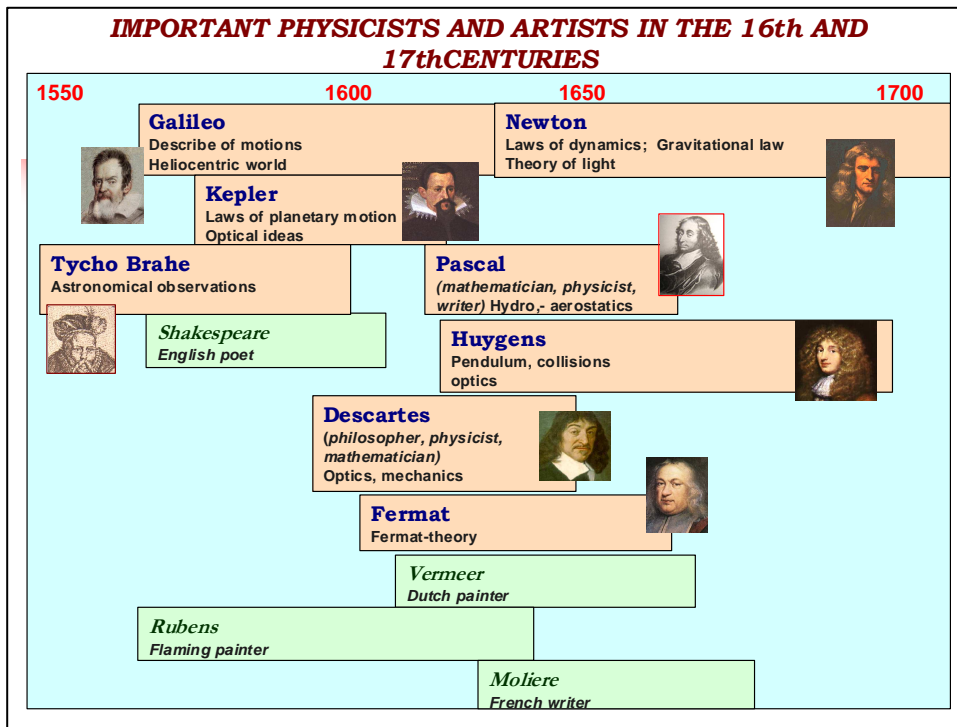


Figure 1

### IV. Details from the presentation of the period of geniuses.

Let me present here some special details from the chapter of the geniuses of the 16<sup>th</sup> and 17<sup>th</sup> centuries as examples in order to illustrate the character of the course.

I would like to put more emphasis on Tycho Brahe's interesting life, because I can use my remarkable experiences and informational materials acquired in the excursion which was organized during the time of the GIREP conference held in Lund, moreover I can show the very interesting illustration from his book and my photo of his tomb in Prague.

The next examples emphasize the wider cultural aspects mentioned in connection with Galileo, Pascal and Newton, among others.

To make colorful the history of Galileo's life and the results he achieved I can use the following, among others. To highlight the fact that 400 years after Galileo, we sometimes happen to follow Aristotle's way of thinking, I ask my students the following questions:

- 1) A cyclist moving with uniform velocity on a horizontal -section of road, throws a golf-ball up in the air. Find the right answer from among the next ones:
  - a) The ball falls back in front of the cyclist.
  - b) The ball falls back into the hand of cyclist.
  - c) The ball falls back behind the cyclist.

- 2) Assume that you have to hit a small sandbag ( $V = 0,5 \text{ dm}^3$ ) by a bow. The sandbag is dropped from a loophole which is at the same height as you are. The arrow must be shot out at a trumpet –call at the moment of the dropping. In which direction do you aim?
- A little bit over the sandbag
  - Exactly at the sandbag
  - A little bit under the sandbag

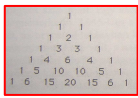
The two paintings, *The Moon* and *The Jupiter*, created by Donato Creti in 1711, were painted to commemorate Galileo's discoveries. These are parts of a series in which stars and planets are depicted, and which was produced by the painter on the basis of his own observations through a telescope.

One of Galileo's apprentices, Viviani found that the genius of Galileo was the scientific equivalent to Michelangelo's art. He declared that Michelangelo's spirit moved from his old dying body into the newborn Galileo's body during the days between the death of the former and the birth of the latter. So Viviani did his best to arrange what was later realized that the tombs of Galileo and Michelangelo are in the same church in Florence.


In honour of the hosts of this conference, I would like to show you one of the slides that present Blaise Pascal, as the next example from the lectures of our course. (Figure 2) Knowing his versatility, his activity as writer and philosopher is also mentioned beside his achievement in mathematics and physics. According to a famous Hungarian poet, who also dealt with topics of linguistics, the most beautiful sentence of the world literature is the next one by Pascal: "The eternal silence of these infinite spaces frightens me." (*Le silence éternel de ces espaces infinis m'effraie.*)


**Blaise Pascal (1623 – 1662)**

**His scientific results**




**In Mathematics:** Pascal's theorem (geometry)  
Pascal's triangle  
Probability Theory  
Pascal's calculator: the Pascaline





**In Physics:** hydraulic press – based upon the  
Pascal's law  
measurement of air pressure



**According to a famous Hungarian poet, who also dealt with topics of linguistics, the most beautiful sentence of the world literature is the next one:**  
**"The eternal silence of these infinite spaces frightens me."** (*Le silence éternel de ces espaces infinis m'effraie.*)




Figure 2

I would like to review briefly my student's "multimedia like" presentation about Newton's life-work, which complemented my lecture. His presentation was full of original ideas: it started by a route from our university to Newton's birthplace by Google Earth, then followed some details from the French "Once upon a time" cartoon series about Newton's life. A scene from the feature film, *The Da Vinci Code* called the audience's attention to the tomb of Newton, and the presentation was closed by a picture sequence about the scientist accompanied by details from the *Carmina Burana*.

## V. Testing the students' knowledge.

As this is an optional subject with a rather special character, at the end of the course we cannot use the usual testing. So the written examinations determine the mark, which is a midyear mark, but there is a possibility to hold a short lecture (like the previously mentioned Newton-presentation) to get a better mark. To the distance learners a possibility is suggested: they can receive a maximum "satisfactory" mark by solely work done at home. This work has two parts: an essay about a physicist (its length has a limit and the reference is compulsory) and an individually different question series. To answer these questions the students have to browse the course-book. Here I show some examples of the types of these tests.

1. While the birth date and death date of the physicist are not important, I think that it is important to know the century, the given physicist lived in, to know about the length of his life, and to estimate who were his contemporaries.

In which century was Galileo born and how long did he live?

- |          |       |
|----------|-------|
| A. 16th  | 1. 45 |
| B. 17th  | 2. 78 |
| C. 18th. | 3. 85 |

Who met or could have met Maxwell?

- |                |            |           |
|----------------|------------|-----------|
| A. Shakespeare | D. Eötvös  | G. Rubens |
| B. Joule       | E. Liszt   | H. Monet  |
| C. Watt        | F. Faraday | I. Kelvin |

2. It is worth calling students' attention to physicists who worked in several fields of physics or also other areas.

There was a person who was an English physicist, medical doctor, painter, musician, linguist at the same time, and he lived at the beginning of the 19th century. Who was it?

- A. Newton
- B. Huygens
- C. Young
- D. Fresnel

3. Physicists and concepts or laws which are connected to their names occur in several classifications.

„Associations" – Connect the physicists with ideas!

- |               |                           |
|---------------|---------------------------|
| 1. TELLER     | A. TOTAL REFLECTION       |
| 2. COPERNICUS | B. ENTROPY                |
| 3. BLACK      | C. PULLEY                 |
| 4. KEPLER     | D. SUN-CENTERED THEORY    |
| 5. CLAUSIUS   | E. HYDROGEN BOMB          |
| 6. ARCHIMEDES | F. SPECIFIC HEAT CAPACITY |

4. It would be good if, in addition to answering the question itself, the students could find out what makes the other names familiar to them.

Who was the BCS-theory named after?

- |              |             |                |
|--------------|-------------|----------------|
| a. Becquerel | d. P. Curie | g. Schrödinger |
| b. Békésy    | e. Cooper   | h. Schrieffer  |
| c. Bardeen   | f. Chadwick | i. Strassmann  |

5. Questions related to arts.

In which century and where did painters start to depict mirrors on their paintings, or to use them in creating their work?

List 5 physicists and 4 famous artists who were born in the 18th century.

**The crossword puzzle as a possible means of playful assessment.**

The level of knowledge can be also checked in a playful way, by a crossword puzzle.

In the next example the questions remind us of the connection between physics and the other areas of the culture. (Figure 3) The main question is to find the missing word in Pythagoras' saying: „All things are *numbers*”.

	<b>1.</b>	L	E	O	<b>N</b>	A	R	D	O		
			<b>2.</b>	H	<b>U</b>	Y	G	E	N	S	
	<b>3.</b>	T	H	O	<b>M</b>	S	O	N			
		<b>4.</b>	G	A	<b>B</b>	O	R				
<b>5.</b>	K	E	P	L	<b>E</b>	R					
		<b>6.</b>	V	E	<b>R</b>	M	E	E	R		
	<b>7.</b>	F	R	E	<b>S</b>	N	E	L			

Figure 3

- Besides being the one of the greatest painters, he formulated the law of action-reaction at first.
- Whose biography can be written under this title: „From the pendulum clock to the longitudinal light wave through the rings of Saturn”?
- Two great physicists had this same name; one of them later became Lord Kelvin.
- He created the theory of spatial imagery, which also gave inspiration to S. Dali.
- He had written the laws of motion of the planets, and also created a camera obscure, and using it, later painted a landscape.
- Who was the Dutch painter, who could know Huygens personally?
- French physicist, the lenses which are used in the lighthouses bear his name.

**VI. Conclusions**

It is a great adventure to investigate the history of the discoveries in physics and the great physicists' lives.

The history of physics can help a lot in studying the main laws of physics: it is easier to understand them knowing the life of the physicist, and the historic and cultural background of the discovery. It helps to raise interest in *getting further knowledge* in physics and in the cultural surroundings of the discoveries. It is easier to remember the laws of physics using associations from the stories. We can confirm that there is only one integrated culture, showing the important parallels between science and art.

Finally let me quote a true saying, which can be the motto of each physics course, especially of the course of The Cultural History of Physics:

„A student is not a vessel to be filled, but a lamp to be lit.” (Variously quoted as a Hebrew saying, or as an adaptation of a quotation by Plutarch.)

#### **References**

[1] Simonyi K., A fizika kultúrtörténete, *Budapest, 1998*

[2] <http://www.mindentudas.hu/szabog/index.html>

# **A study on criteria used by students to infer the physical reality of objects: building categories of analysis**

Fábio Marineli

Federal University of Goiás, Brazil – fmarineli@jatai.ufg.br

Maurício Pietrocola

University of Sao Paulo, Brazil – mpietro@usp.br

## **Introduction**

Research in Science Education has shown the importance of considering the nature of science as an integral part of scientific understanding (NIAZ, 2009; SCHWARTZ and LEDERMAN, 2008; GIL-PÉREZ *et al*, 2001). Many of these studies disclose students' perception of a science that rarely exceeds a naive empiricism, one that bestows scientists the domain of a safe method to explore nature. This commonly accepted concept places the content of science as revelations about the internal organization of the world.

Furthermore, in teaching material texts and in the words of teachers, the belief in the existence of an "essential reality" not directly perceived by the senses arises. This reality, obscured by the limitations of our perception, is the source of ultimate truths. Then, the role of a scientist is to accomplish this through a safe method, supported by experimentation and logical thinking.

This concept of science reflects an empirical-positivist idealization and has profoundly influenced teaching, forging a distorted view of the nature of scientific activity and the knowledge it produces. This concept contrasts with the important aspects of scientific activity effectively carried out, deserving emphasis in science education. Millar (1989) highlights two of these aspects: characterizing scientific activity as a human activity and the eminently provisional character of scientific ideas.

The statute of objects in the scientific theories and laws is another aspect of the nature of science to be considered. Ideas such as electric fields, energy and photons can only be perceived by means of a creative imagination, guided by the modern theories of science. These require disengaging the immediate senses and increasing theoretical belief. One of the goals of physics education should be to provide the means to conceive and deal with the entities within the theories and models (OGBORN & MARTINS, 1996).

Considering them as mere abstractions, or treating them as day-to-day objects could distort the physical knowledge, hence possible learning problems or difficulty in using such knowledge outside the classroom (PIETROCOLA *et al*, 2001). Thus, part of the physics education requires an ontological attitude shift (FINE, 1986) to conceive objects and criteria that can justify their existence in theories or models.

This paper presents part of a research project that investigates the criteria used by undergraduate physics students to confer reality to such entities in physics theories, because besides the content of theories, we understand that understanding the nature of these theories and the objects that are part of the scientific representation of the world, are also part of the scientific education of future teachers.

## **Realism**

The everyday and science reality are characterized differently in epistemological terms (BERGER and LUCKMANN, 1984). This is an important divisor to address realism as a philosophical problem. The usual day-to-day life we experience is within a stable set of objects and relationships identified as an "immediate reality." People from the same social group tend to perceive it similarly and rarely reflect on this. Its *dynamic stability* (permanence



in mutability) relays its own existence and autonomy, thereby considering it a “Reality”, unique, unchanging and permanent (BERGER and LUCKMANN, 1984).

In the scientific sphere the relationship with the entities is not the same as with everyday life. Many of the entities that comprise the representation of the world of science are far from the senses. This results in questions whether our assumptions about the world, which use these entities, are able to deal with the structure of the world, if they are the reflections of structures that exist independently of our theories.

On this theory/science objects relationship with the world, the scientific realism upholds that scientific theories truly describe the world, affirming the existence of entities postulated by the theories (LECOURT, 1999). This view is based on the idea of an external world that is independent of our knowledge and experience, which science seeks to attain substantial and correct information of its aspects.

Contrarily, anti-realism upholds that scientific theories are merely useful tools to obtain observable predictions. The meaning of science does not result from attempting to represent a world that exists independently of us, but rather from pragmatic virtues of the theories. These do not necessarily address the world as it is, but if a theory worked properly it could be accepted.

There are many arguments upholding realism and anti-realism, e.g., if what is deemed important emphasizes the predictive success of Science, the realist trend is more suitable, however, if it is to show the possibility of one event explained in different ways, then the anti-realists arguments are better. Both scientific realism and anti-realism propose to assign a meaning to empirical science, understanding it within a philosophical construct that allows to construct its global interpretation and analyze its foundation and purpose (PLASTINO, 1995), but neither are free of problems.

### The research

This research addresses the criteria used by undergraduate Physics Education students in assigning levels of reality to objects in different concepts and views of the world. To achieve this objective, we applied a questionnaire<sup>1</sup> to undergraduate students in their final semesters of Physics Education at the University of Sao Paulo, Brazil. The questionnaire was adapted from Pinheiro’s work (2003), who conducted a similar research with high school students. The Likert scale was used to assign levels of reality to the objects, also a justification presented for the chosen level of reality.

Our questionnaire comprised three “classes” of objects/entities: the first (Class 1) consists of objects typically considered “real” in the usual sense, present in everyday life; the second (Class 2) consists of abstract domain entities; the third (Class 3) consists of entities from the scientific area. Table 1 displays the entities used in the questionnaire.

Objects/Entities	Class	Source
Cotton, air, scent, chair, star, melody, lightning	Class 1	“Everyday”
Friendship, thought, dream	Class 2	“abstracts”
Atom, caloric, gravitational field, electron, magnetic force, mass, relativity of time, spin	Class 3	“scientific”

**Table 1 – Objects and/or entities.**

This questionnaire was administered to students of the Physics Teaching Methodology II course, at the University of São Paulo, in the 2nd semester of 2003, and

<sup>1</sup> Due to lack of space, the questionnaire is not presented in this work.

answered by 33 students. Generally, the students take this course at the end of their undergraduate course.

## **Results**

The students answered the questionnaire indicating the intensity degree of reality for a particular entity, then justifying their choice. In a previous work (MARINELI and PIETROCOLA, 2009) we presented the number of responses given by the students, for each level of reality in the Likert scale, for the entities in Table 1.

Then, to understand the students' criteria to assign the degrees of realities to the entities, we analyzed the justifications provided, which were grouped into 11 categories. Some of the categories were suggested by Pinheiro's work (2003), while others emerged from our own analysis.

The students' justifications were usually words or short phrases. When there was more than one type of justification in the student's response, it was classified in more than one category.

The categories are listed below.

### ***Category A – C x A (concreteness / materialness / solidity x abstraction / idealization / imagination)***

The responses categorized here are fixed on "concreteness", on the materialness or solidity of an entity to justify the high levels of reality or, conversely, on abstraction, the idealization and imagination to justify the lower levels. They are always intersubjective aspects (and not intrinsic to a single individual). Some of the justifications categorized are: "Concreteness", "It is materialness", "Abstraction", "functional idealization"<sup>2</sup>.

### ***Category B – Description / Characterization***

This category comprises answers that make some kind of description of the entity, or somehow characterize it, as a justification for the degree of reality attributed. Examples: "Image, index of the existence of a solar body" [for the star], "It is brain waves that are translated into real images" [for thought and dream], "pure abstract speculation" [for the caloric and gravitational field].

### ***Category C – Understanding***

This justification expresses the dependence between the intelligibility of the entity and intensity of the reality attributed to it. Examples: "[...] it is part of my real-world concept" [for the air and chair], "I do not know what is" [for thought], "Hard to understand" [for the relativity of time], "I do not understand" [for the spin].

### ***Category D – Existence***

Here the statements of simple existence or non existence of a specific entity were grouped, without another justification of the degree of reality attributed. Some examples of these responses are: "Unreal", "Does not exist", "We know it exists".

### ***Category E – Model***

This classified the phrases that use the term "model" as a justification for the degree of reality attributed or those that make some reference about them. Examples: "Model", "Exists as a model", "It is a representative body" [for the caloric and gravitational field].

---

<sup>2</sup> The students' sentences were written in Portuguese. The English translation is ours.

### **Category F – Outside the limits of knowledge**

Here the statements about *not possible to know for sure about the entity* were included. Examples: “*We cannot evaluate*” [for the dream], “*It may be a human invention*” [for the electron], “*Not even the Physicists know what it is*” [for the electron].

### **Category G – Perception**

This category comprises justifications based on perception through the senses, possibilities of manipulation, of interaction; perception through devices, measuring, or even perceptions subject to or related to feelings: “*I can see*”, “*I can touch*”, “*I feel*”, “*I see by using adequate devices*” [for the atom], “*I can measure*”, “*I never saw it*”.

### **Category H – Perceived effects**

These justifications are based on the perception of an effect attributed to the entity, explained through it. Examples: “*It causes observable changes*” [for lightning], “*I cannot regularly handle it but I perceive the related phenomena*” [for the atom and electron], “*Remarkable effects*” [for the gravitational field and spin], “*I can feel its effects*” [for the magnetic force].

### **Category I – Subjectivity / Interpretation**

This category comprises the justifications that explain the perception of an object that is unique or intrinsic to an individual. Some examples of the affirmations are: “*My idea of scent is an interpretation that my brain makes*”, “*It exists only for the individual who conceived it*”, “*Subjective factor*” [for friendship].

### **Category J – Explicative support**

These responses express that the existence of the entity in question must be real in order to explain something known, that is, it is possible to explain some other phenomenon through it. It only appeared for the science entities. Examples: “*It explains well the structure of matter [...]*” [for the atom and electron], “*I cannot touch it, but serves to explain some things*” [for the spin].

### **Category K – Transitive**

In these justifications, the intensity of reality of the object depends on the referendum of something or someone. It transfers the responsibility for attributing reality to another, including for teaching instances: These are some examples for this type of response “*Studies have confirmed its existence*” [for the star], “*experimentally proven*” [for the relativity of time], “*I study*”, “*Einstein said!!!*”.

### **Total justifications in each category**

The following table displays the total distribution of the sentences classified in each category.

Category	Class 1 (%)	Class 2 (%)	Class 3 (%)
<b>Category A – C x A</b>	19.0 14	.6	12.9
<b>Category B – Description/characterization</b>	9.7 32	.3	12.9
<b>Category C – Understanding</b>	3.5 4.	2	2.8
<b>Category D – Existence</b>	5.3 12	.5	8.0
<b>Category E – Model</b>	0.4 0.	0	17.8
<b>Category F – Outside the limits of knowledge</b>	2.2 1.	0	2.1
<b>Category G – Perception</b>	54.4 26	.0	24.4
<b>Category H – Perceived effects</b>	1.3 0.	0	4.5
<b>Category I – Subjectivity / Interpretation</b>	3.1 8.	3	0.0

<i>Category J – Explicative Support</i>	0.0 0.	0	6.3
<i>Category K – Transitive</i>	0.9 1.	0	8.4

**Table 2 – percentages of the answers classified in each category, by Class.**

From this table we can see that category G “Perception” is the one with the highest number of justifications for the entities of Classes 1 and 3, and the second highest number is for Class 2. That is, the direct perception of something is the factor that contributes most to the inference on the reality of the entities in these classes. For Class 1 (the daily entities) the difference in the number of justifications that relied on perception in relation to others represents a significant difference: half of the justifications used in this category appeals to the senses. This seemed reasonable to us given that Class 1 brings together objects of the everyday world, an area in which the sensory organs are more operational.

For the entities of Class 3, a difference observed in the responses in this class from the others is that now justifications in the E “Model” categories appear, in addition to a significant increase in the justifications that entered the H “Perceived Effects”, J “Explanatory support” and K “Transitive” categories. This may be explained by the fact that the entities of science cannot be directly accessed.

For Class 2, there was a greater number of justifications categorized as “Description or characterization.” We can hypothetically say that the elements of this class are not as well characterized or defined as the other two classes, hence the reasons why the students define them.

The eleven categories inferred from the data analysis comprise a large number. Thus, in searching for a synthesis, we grouped these categories according to the focus of the justification declared by students. Five categories focused on the object/entity on which it seeks to justify the intensity of reality (Categories A, B, D, E, J); other four categories are directly focused on the subject itself (Categories C, G, H, I); There is still one whose focus is on another subject or something external to the relationship between the subject that responds and the entity (Category K). Category F was separated from the others in this form of grouping.

Adding the justifications in these groupings, we have the following values:

	<b>Class 1 (%)</b>	<b>Class 2 (%)</b>	<b>Class 3 (%)</b>
<i>Categories focusing on the object (A, B, D, E, J)</i>	34.5 59	.4	57.8
<i>Categories focusing on the object itself (C, G, H, I)</i>	62.4 38	.5	31.7
<i>Categories focusing on the referendium of something or someone (K)</i>	0.9 1.	0	8.4
<i>Outside the limits of knowledge (F)</i>	2.2 1.	0	2.1

**Table 3 – percentage of responses classified category in each category, by Class.**

It is possible to see in the table that while for objects of Class 1 (daily) the focus of the justifications is mainly on the subject that is attributing reality to the object, for Classes 2 and 3 the tendency is for the focus to be directly on the object. For Class 3, as aforementioned, there is also an increase in the responses that attribute to a third party the justification for attributing the degree of reality.

### **Final considerations**

The categories that are listed enable addressing some aspects associated to how students understand the supposed “reality” of the objects they find in different contexts.

Some results were expected, such as the fact that the students used, in a preferential manner, access through the senses or a direct perception for the entities from the common

everyday area. However, there was also a significant number of such justifications for the scientific area. Some ideas of Berger and Luckmann (1984) help us interpret this result. The scientific field is a field delimited of meaning within the everyday reality, which in turn is compulsory and dominant. Thus, no one is separated from the common everyday field, and because of this, one can address entities that are present in the scientific theories and models in the same way the day-to-day objects are addressed. This may constitute an ontological obstacle in the future, preventing from addressing more differentiated scientific objects from those present in everyday life, as for instance the elementary particles that have a dual nature: they are particle and wave at the same time!

The difference between the concentrated focus on the object-type justifications (which appear more often for the entities of science and the abstracts) and the type focused on the subject (predominant for the everyday entities) shows that to a certain extent the university students characterize differently the entities from different conceptual domains.

We consider that the definition of these categories has the potential to lead to further studies on this research topic and to better inform us on the question of the ontological status of the science entities for physics students.

## References

- BERGER, P. and LUCKMANN, T. **The social construction of reality: a treatise in the sociology of knowledge**. London: Penguin Books, 1984.
- FINE, A. **Unnatural attitudes: realist and instrumentalist attachments to science**, *Mind* 95, pg. 149-177, 1986.
- GIL-PÉREZ, D. *et al.* Para uma imagem não deformada do trabalho científico. **Ciência & Educação**. 7(2), 125-153, 2001.
- LECOURT, D. (org). **Dictionnaire d'histoire et philosophie des sciences**. Paris: Puf, 1999.
- MARINELLI, F. and PIETROCOLA, M. **Um Estudo sobre Critérios de Atribuição de Realidade Utilizados por Estudantes de Física**. XVIII Simpósio Nacional de Ensino de Física, 2009, Vitória, Brazil. Atas do XVIII SNEF, 2009.
- MILLAR, R. **Doing Science: image of science in science education**. Lewes, Falmer Editions, 1989.
- NIAZ, M. Progressive Transitions in Chemistry Teachers' Understanding of Nature of Science Based on Historical Controversies. **Sci & Educ**. 18(1), 43-65, 2009.
- OGBORN, J.; MARTINS, L. Metaphorical understanding and scientific ideas. **International Journal of Science Education**, vol.18, No. 6, 631-652, 1996.
- PIETROCOLA, M.; ZYLBERSZTAJN, A.; CRESO FRANCO, A.; GILBERT, J. Theory, Model, and Reality: Science and Education. In: JOHN GILBERT; CAROLYN BOULTER (Orgs) **Developing Models in Science Education**. Amsterdam: Kluwer Academic Publishers, 2001.
- PINHEIRO, T.F. **Sentimento de realidade, afetividade e cognição no ensino de ciências**. PhD thesis in Science Education. Federal University of Santa Catarina, Florianópolis, Brazil, 2003.
- PLASTINO, C.E. **Realismo e anti-realismo acerca da ciência: considerações filosóficas sobre o valor cognitivo das ciências**. PhD thesis in Philosophy. University of Sao Paulo, Sao Paulo, Brazil, 1995.
- SCHWARTZ, R. and LEDERMAN, N. What Scientists Say: Scientists' views of nature of science and relation to science context. **Int. J. Sci. Educ**. 30(6), 727-771, 2008.

### 3.2 – University teaching/learning proposal

---

# **Applying the contents of thermodynamics in a multi-phased process in university – What is the problem?**

*Risto Leinonen, Mervi A. Asikainen, Pekka E. Hirvonen*

*risto.leinonen@uef.fi*

*University of Eastern Finland*

## **ABSTRACT**

This research focuses on analyzing students' problems in a qualitative problem-solving related to the ideal gas processes. A paper and pencil test was implemented on the introductory courses of thermal physics in the University of Eastern Finland after the topic had been covered in teaching. Altogether 111 students participated in the test. For success in the test one should understand the first law of thermodynamics, thermal processes, and interdependences for certain quantities. Our results show that the students faced major problems related to heat and work: they had difficulties in determining the signs of these quantities in a cyclic process, in differentiating these concepts, and in understanding the role of work in changing the internal energy of the system. Furthermore the students had erroneous conceptions about the dependencies between quantities, they confused processes, and graphical presentations were not utilized. These results gave us some ideas how to improve students' learning outcome in the future by designing a novel teaching intervention. We also suggest that the use of graphical representations should be varied more, so that students could see graphical representations as problem solving tools besides understanding their physical meaning.

## **KEYWORDS**

Thermal physics, learning, teaching, university

## **INTRODUCTION**

Thermal physics is unquestionably one of the most important areas in physics. The laws of thermodynamics set the unbreakable rules for applications and innovations in every field of science and engineering. This study focuses on analyzing students' ability to apply the contents of thermodynamics in a qualitative task after instruction has taken place.

### **Literature review**

Several studies have been implemented to investigate students' ability to understand and apply the first law in different processes of an ideal gas (Leinonen, Räsänen, Asikainen, & Hirvonen, 2009; Loverude, Kautz, & Heron, 2002; Meltzer, 2004). The most important findings indicate that students cannot apply the first law, they have problems to understand concepts at microscopic level, and process and state quantities are not differentiated. In addition, Meltzer

(2004) reported that students have problems in using the  $pV$  diagrams and in understanding heat transfer. Thomas and Schwenz (1998) noticed that students do not understand reversibility, they do not think there is heat transfer during the isothermal process, and they often misinterpret the energy conservation law.

One widely reported problem is that students confuse the concepts of temperature and heat (e. g. Jasien & Oberem, 2002). Results from countries with different languages indicate that the problem is not only linguistic (e. g. Barbera & Wieman, 2009; Jasien & Oberem, 2002; Leinonen et al., 2009). The concept of heat seems to be problematic for text book writers as well: an analysis conducted by Brookes, Horton, van Heuvelen, and Etkina (2005) revealed that only one text book used the concept of heat properly while others used it inconsistently.

Attempts to overcome these difficulties include, for instance, a development of a tutorial addressing these topics (Cochran, 2005) and designing a laboratory-based curriculum (Kautz, Heron, Loverude, & McDermott, 2005). These approaches seemed to improve students' understanding though Cochran (2005) remarked that there might have been other impacting factors as well.

### **Research question**

Research conducted in the area of learning and teaching thermodynamics at university level has revealed students' misconceptions and problems. Our study continues this type of research by testing students' knowledge after instruction. A research question was formulated as follows:

*What kind of problems university students face in solving a qualitative task about a multi-phased process of an ideal gas after an instruction has taken place?*

## **METHODS**

The data collection methods and the sample are introduced in this section.

### **Data collection**

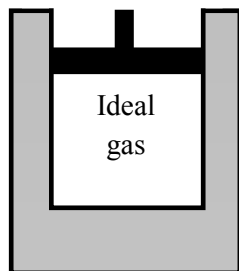
To probe students' understanding we used the test designed by Meltzer (2004). Originally the diagnostic test was used as a base for interviews but we modified it as a paper and pencil test. Two original questions were excluded because they were not suitable for our purposes.

The context of the test was an ideal gas in a piston-cylinder system. A cyclic process consisting of isobaric, isothermal and isochoric processes was introduced to the students and seven questions related to the processes were presented. For success in the test, one should understand the first law of thermodynamics, thermal processes, and microscopic explanations and interdependences for certain quantities, like temperature and particles' kinetic energy.

The first two questions were related to an isobaric expansion of an ideal gas. The first question dealt with the work done in the process while the second one focused on the change in particles' kinetic energy. Questions 3 and 4 related to an isothermal compression process addressed the change of particles' kinetic energy and the direction of heat transfer. The last part of the cyclic process, an isochoric process leading to the initial state, included one question about the change of gas particles' kinetic energy. Finally, the signs of work done and heat transferred during the whole process were asked in the questions 6 and 7. (Meltzer, 2004) Figure 1 presents an example



about the tasks. The students were asked to select right answers of the multiple choices and to explain their reasoning in order to get deeper information about their conceptions.



A fixed quantity of ideal gas is contained within a metal cylinder that is sealed with a movable, *frictionless, insulating* piston...

...We now begin Process #1: The water container is gradually heated, and the piston very slowly moves upward. At time B the heating of the water stops, and the piston stops moving when it is in the position shown in the diagram below:

Question #1: During the process that occurs from time A to time B, which of the following is true:

- a) positive work is done on the gas by the environment,
- b) positive work is done by the gas on the environment,
- c) no net work is done on or by the gas.

Explain your reasoning.

Figure 1. An example of the tasks in the test (modified from Meltzer 2004).

## Sample

The data was gathered in the campuses of Joensuu and Kuopio in the University of Eastern Finland in 2008, 2009, and 2010. The data gathering took place in the introductory courses of Thermal physics and Basic physics IV that are rather traditional lecture and exercise courses. Students in both campuses had already taken the introductory physics courses including topics of mechanics and electricity before participating in these courses. The number of students taking the test was 76 in Joensuu and 35 in Kuopio. The total sample consists of 111 students who have studied required processes, laws, and models in lectures and exercises. The data from two samples were combined because of similarity of the data. The bigger sample improves the generalizability of the results.

## RESULTS

The first part of the results concerning students' choices in the multiple-choice tasks gives us information about the issues where students encountered problems. The second part discussing about students' reasoning in the tasks gives a deeper view to students' conceptions.

### Students' choices in multiple-choice tasks

The proportions of correct choices in the multiple choice questions are presented in Figure 2. Looking at the results helps one to realize that only a part of the topics is learned sufficiently. The students performed questions 1, 4, and 5 related to the work and heat in the sub-processes sufficiently but lower proportions of correct answers in questions 2 and 3 concerning the change

of to talk kinetic energy of particles in the isobaric and isothermal processes are a minor disappointment. Remarkably low numbers of right answers in questions 6 and 7 related to the magnitudes of work and heat in a cyclic process cause a reason for concern.

The results indicate that the students have problems to understand the nature of quantities *work* and *heat* (questions 6 and 7). The relation between kinetic energy of particles and internal energy is not understood properly either (questions 2 and 3).

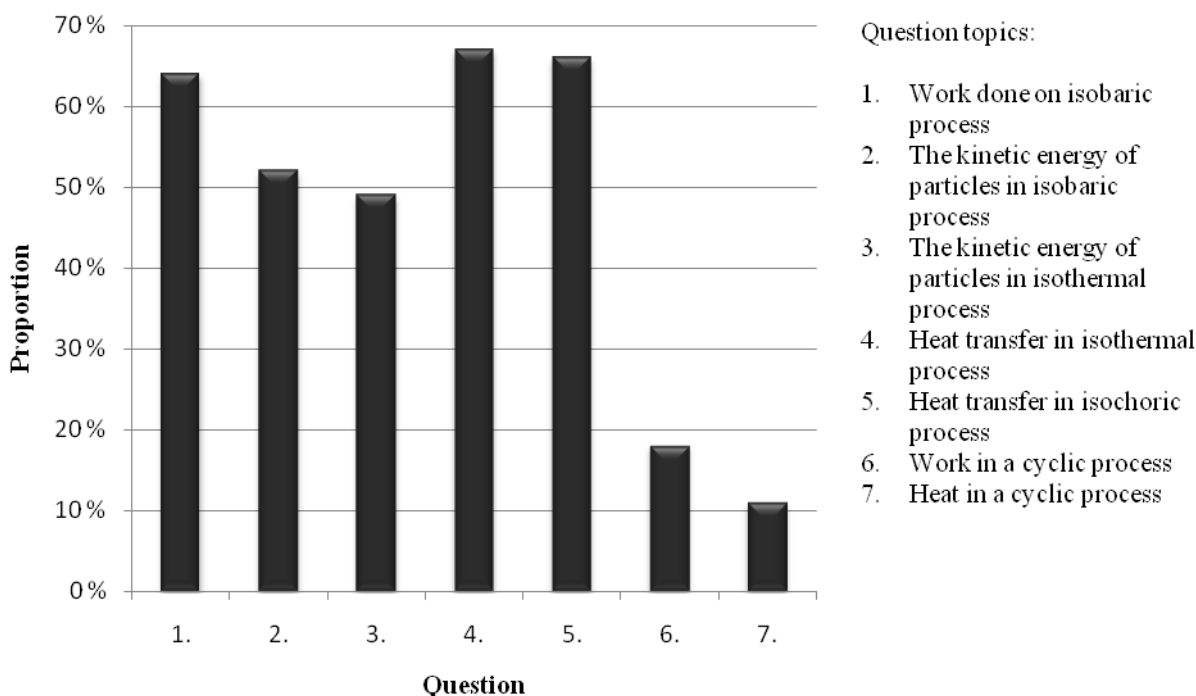


Figure 2. Proportion of students' correct answers in test questions (N=111).

### Students' reasoning

The proportions of correct multiple-choice answers revealed the topics that students encountered problems with, but more detailed information was received when the students were asked to explain their answers. Students' classified responses are presented in Table 1. To make the results more readable we excluded the conceptions that occurred only once or twice in the test. Because of this and the number of blank answers the sums never reach 100 %.

Table 1 clearly shows that the students encountered several kinds of problems that are introduced in the following chapters.

#### *Problems with a cyclic process*

The most common problem was students' inability to determine the signs of work and heat in a cyclic process in the tasks 6 and 7. 56% of the students faced this problem with *work* and 59% with *heat*. The most convenient way to find out the sign of work,  $pV$  diagrams, was used only by a few students. This problem indicates that the process quantities were not grasped though the tasks 1 and 4 gave more promising results concerning understanding these topics.

Table 1. Students' reasoning in multi-phased process tasks after teaching (N=111). Correct reasoning is in italic style.

Question	Characteristics of students' reasoning	Proportion
1.	<i>Work is done by gas because its volume increases</i>	62 %
	Heat and work are not distinguished	17 %
	Direction of work is misunderstood	16 %
2.	<i>Part of the energy is used to do work</i>	35 %
	Work's impact on energy is neglected	29 %
	Problems with energy or heat	25 %
3.	<i>Temperature stays constant, therefore internal energy stays constant</i>	36 %
	Erroneous dependencies between quantities	32 %
	Problems in recognizing process (e.g. adiabatic vs. isothermal)	10 %
4.	<i>Internal energy stays constant, therefore heat has to be transferred from gas to water</i>	55 %
	Problems with work	5 %
	Problems in recognizing process (e.g. adiabatic vs. isothermal)	29 %
5.	<i>All energy leaves gas as heat; no work is done</i>	57 %
	Problems with energy or heat	17 %
	Erroneous dependencies between quantities	3 %
6.	<i>Comparing magnitudes of work in processes</i>	10 %
	Work in a cyclic process is not understood	56 %
	The whole process is not observed	10 %
	Heat and work are not distinguished	7 %
7.	<i>Because work done <u>by</u> gas is negative, heat transferred <u>into</u> gas must be negative in a cyclic process</i>	15 %
	Heat in a cyclic process is not understood	59 %
	The first law is applied erroneously	5 %
	The whole process is not observed	5 %

Another issue observed was students' tendency to take only a part of the process under consideration, when 10% and 5% of the students faced this problem in the tasks 6 and 7.

#### *Erroneous dependencies between quantities*

When the students were asked about the kinetic energy of particles, it became obvious that they misunderstood the dependencies between quantities; this was emphasized in the tasks 3 and 5. The students, for example, paralleled the kinetic energy of particles to pressure or volume. Other students may have thought that heat is directly proportional to temperature instead of being a measure for spontaneously transferred energy.

#### *Problems to differentiate heat and work*

Task 1 and 6 revealed that students were not able to make a difference between heat and work. Task 1 focused on this problem and 17% of the students' responses were classified in this class. Some students did not make any difference between these concepts while others used them imprecisely.

#### *Problems with work*

The most common problem related to the use of work was the lack of understanding the impact of work on internal energy in the task 2. Altogether 29% of the students used this type of reasoning. Task 1 revealed another problem: 16% of the students did not understand the direction of the work done in the system. Both these conceptions occurred also in the task 4 where 5% of the students faced one or another.

#### *Other problems with energy and heat*

Tasks 2 and 5 revealed numerous misconceptions related to energy. The students discussed about the potential energy of the particles or they did not understand the connection between microscopic and macroscopic energies. Problems with heat included, for example, inability to understand the direction of heat.

#### *Problems with processes*

Students' problems in recognizing processes became obvious in the tasks 3 and 4. Isothermal and adiabatic processes were often confused and some students had problems to know what different processes mean. One student mentioned in the task 5 that "it is an isothermal process in constant volume" which indicates that terminology is anything but understood.

## **DISCUSSION**

In this study we examined students' problems related to the thermodynamics. The data was collected after instruction had taken place in the courses of thermal physics in two different campuses. This section concentrates on reviewing our findings in the light of earlier research and presenting the implications for teaching.

Numerous students' misconceptions and problems found in this study are in an agreement with the earlier findings. The problem in finding out the signs of work and heat in a cyclic process have been reported by Meltzer (2004). Earlier research has also reported about problems related to the erroneous dependencies between quantities, especially between microscopic and macroscopic level explanations (e.g. Meltzer, 2004; Rozier & Viennot, 1991). Numerous problems with the concepts of heat and work are also well-documented (Loverude et al., 2002;

Meltzer, 2004), as is the problem with understanding the role of *work* in changing the internal energy (e.g. Goldring & Osborne, 1994).

Students' problems with processes (Cochran, 2005; Kautz et al., 2005) and especially confusing isothermal and adiabatic processes (eq. Loverude et al., 2002) are well-known. Problems in understanding relations between particles' kinetic energy and temperature have also been reported earlier (Meltzer, 2004).

However, some new findings were also made. In Meltzer's (2004) interviews approximately one third of the students spontaneously used  $pV$  diagrams to determine the sign of work, but our study showed the proportion of these students to be only five percent. This was a surprise considering the emphasis that diagrams have had on the courses. Students' reference to the potential energy of ideal gas particles is a new finding that has not been reported in the literature.

In order to improve students' conceptual understanding in thermodynamics we should modify our teaching. The attempts to overcome the difficulties (e.g. Barbera & Wiemann, 2009; Kautz et al., 2005) presented earlier have shown an improvement in students' understanding. However, these kinds of interventions require a specially designed course and/or new resources and they cannot be included in the traditional lecture-mode teaching as such. To support traditional teaching, we are currently designing a two-hour-intervention that aims at challenging the students to apply their knowledge grasped in lectures and exercises. During the intervention the students get several hints based on the problems found in earlier research and a possibility to discuss their ideas with their peers in small groups. The students are guided to think what they have already learned and to consider its applicability in a new situation.

The most surprising observation in this study was almost a complete lack of graphical representations in students' test responses. This deficiency may be corrected by varying the use of graphical representations more in teaching of thermodynamics. This could help the students in understanding the physical meaning of them and in seeing them as problem-solving tools.

The first step to improve students' learning for a teacher is to become conscious of these kinds of problems and to critically evaluate one's own teaching. No material, curriculum, or equipment can improve the learning outcome, if the teacher is not willing to change her/his practices.

## REFERENCES

### Books

- Cochran, M. (2005). *Student understanding of the second law of thermodynamics and the underlying concepts of heat, temperature, and thermal equilibrium*. Doctoral dissertation, University of Washington at Washington, 2005.
- Kraus, P. (1997). *Promoting active learning in lecture-based courses: Demonstrations, tutorials, and interactive tutorial lectures*. Doctoral dissertation, University of Washington at Washington, 1997.

### Journal Articles

- Barbera, J., & Wieman C. E. (2009). Effect of a dynamic learning tutorial on undergraduate students' understanding of heat and the first law of thermodynamics. *Chemical Educator*, 14, 45-48.
- Christensen, W., Meltzer D. E., & Ogilvie C. A. (2009). Student ideas regarding entropy and the second law of thermodynamics in an introductory physics course. *American Journal of Physics*, 77, 907-917.
- Cochran M. J., & Heron P. R. L. (2006). Development and assessment of research-based tutorials on heat engines and the second law of thermodynamics. *American Journal of Physics*, 74, 734-741.

- Goldring, H., & Osborne, J. (1994). Students' difficulties with energy and related concepts. *Physics Education*, 29, 26-31.
- Jasien P. G., & Oberem G. E. (2002). Understanding of elementary concepts in heat and temperature among college students and K-12 teachers. *Journal of Chemical Education*, 79, 889-895.
- Kautz, C. H., Heron P. R. L., Loverude M. E., and McDermott L. C. (2005). Student understanding of the ideal gas law, Part 1: A macroscopic perspective. *American Journal of Physics*, 73, 1055-1063.
- Leinonen, R., Räsänen, E., Asikainen M., & Hirvonen, P. E. (2009). Students' pre-knowledge as a guideline in the teaching of introductory thermal physics at university. *European Journal of Physics*, 30, 593-604.
- Loverude M., Kautz C. H., & Heron P. (2002). Student understanding of the first law of thermodynamics: Relating work to the adiabatic compression of an ideal gas. *American Journal of Physics*, 70, 137-148.
- Meltzer D. (2004). Investigation of students' reasoning regarding heat, work, and the first law of thermodynamics in and introductory calculus-based general physics course. *American Journal of Physics*, 72, 1432-1446.
- Rozier S., & Viennot L. (1991). Students' reasoning in thermodynamics. *International Journal of Science Education*, 13, 159-170.
- Thomas, P. L., & Schwenz R. W. (1998). College physical chemistry students' conceptions of equilibrium and fundamental thermodynamics. *Journal of Research in Science Teaching*, 35, 1151-1160.

# Learning Physics: a Competency-based Curriculum using Modelling Techniques and PBL Approach

Bernard Blandin  
CESI, Paris, France  
[bblandin@cesi.fr](mailto:bblandin@cesi.fr)

As pointed out by the OECD Global Science Forum in 2006 (OECD-GSF, 2006), in many countries, learning Science and Technology is less and less attractive for young people. At the same time, the overall needs for competences in scientific and technological fields are increasing. Changing the way Science and Technology is learned is becoming of crucial importance.

Besides these general trends, French “*Ecoles d’ingénieurs*” are now compelled to define the learning outcomes of their curricula in the form of a targeted knowledge, skills and competencies framework: the national accreditation body “*Commission du titre d’ingénieur*” proposed, as a reference since 2006, a general “capacities and competencies framework”; and it has now been completed by the European Qualification Framework initiative adopted by European Parliament and Council in 2008, which is supposed to be applied from 2010 onwards.

With the support of our Board, we have decided, in *Ecole d’ingénieurs* CESI, to address these issues in an innovative way, and to face a double challenge concerning our curricula in Science: to define competency-based curricula, and to make learning more attractive by using modelling techniques and tools together with a Problem-based Learning (PBL) approach.

This year, *Ecole d’ingénieurs* CESI has in total 2715 students registered for all its curricula in engineering over the 12 centres, and near hundred teachers in Sciences. So, the new approach has to be progressive, accepted by the teachers and carefully validated before being generalized (Raine & Symons, 2005). This is why the project team has decided to start with a limited experiment involving a few teachers in Mechanics. This experiment is monitored by the Learning Environments Design Laboratory, the Educational Sciences Laboratory of the school.

To measure the effects of the new course and compare the learning outcomes with those of the traditional course, two well-known tests will be used: the Force Concept Inventory (Hestenes, Wells and Swackhamer, 1992), and the Mechanics Baseline Test (Hestenes and Wells, 1992). The FCI will be administrated in October and November 2010 to all the students in the school prior to starting the experiment. This will give a picture of the average level before any course in Mechanics at the school (students in 1<sup>st</sup> year), and after a course given in the traditional way (students in 2<sup>nd</sup> and 3<sup>rd</sup> years). The MBT will also be administrated to the students in 2<sup>nd</sup> and 3<sup>rd</sup> year. The FCI will be used again for the 1<sup>st</sup> year students after the first part of the course in Mechanics (which can be considered as a revision) to measure the gains of the experimental course and to compare them with those of traditional courses given in parallel. The MBT will also be administrated to 1<sup>st</sup> year students before and after the second part of the course with a similar intention: to measure the respective effects of traditional and experimental courses.

This presentation will focus on the methodology used to design the experimental curriculum in Mechanics and will provide some detailed examples of learning situations and problems designed in order to acquire given competencies.

## Our competencies framework for sciences

Within the scope of this project, “competency” has been defined as the ability to use cognitive resources (knowledge), operative resources (skills, competencies) and monitoring indicators, in a given situation (context), to achieve specific outcomes (expressed by the progressive form of a verb, followed by a direct object) (Fig 1). Such a definition is recursive, since a competency can also use another competency as a resource, as shown by the general diagram transcribing our understanding of the competencies required by the “*Commission du titre d’ingénieur*” for sciences, our proposed competency framework for sciences (Fig. 2).

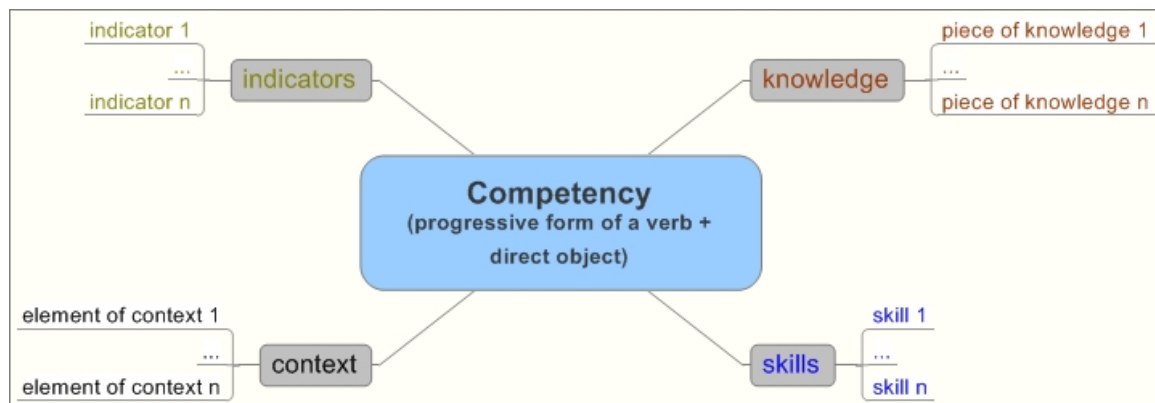


Figure 1: Definition of a competency

The core competency of our competency framework for sciences is “Mobilizing fundamental sciences resources” to help find solutions to problems in various fields of engineering. This competency describes the ability for an engineer to use scientific concepts and principles and to apply them correctly to solve specific problems. It uses 3 “companion” competencies:

- “Using a way of reasoning appropriate to the problem to resolve”, because the ability to select the right way of reasoning about a specific problem facilitates the search of a solution, and we know that students frequently have “misconceptions” in physics, which need to be identified and corrected<sup>1</sup>;
- “Using tools and procedures”, because tools and in particular software tools are more and more necessary in engineering and sciences, in particular with the development of Simulation-Based Engineering Science (NSF, 2006; WTEC, 2009);
- “Collecting and interpreting data”, because this ability facilitates the control of the correctness of the way of reasoning, in particular when the “functional dependency of variables” is mastered (Viennot, 1992).

<sup>1</sup> Many research works have been done throughout the world about these misconceptions, and it would be difficult to cite here all these works. I will just mention the work done in the USA by David Hestenes and his colleagues (Hestenes, Wells & Swackhamer, 1992; Hestenes & Wells, 1992; Horton, 2007), and in France by Laurence Viennot and her team (Viennot, 1979; 1992; Closset, 1983; 1992; Rozier, 1988), and the “Conceptual and Reasoning Difficulties in Science” website (<http://www.card.unp.ac.za/home.asp>) which allow researchers worldwide to share their findings in this domain.



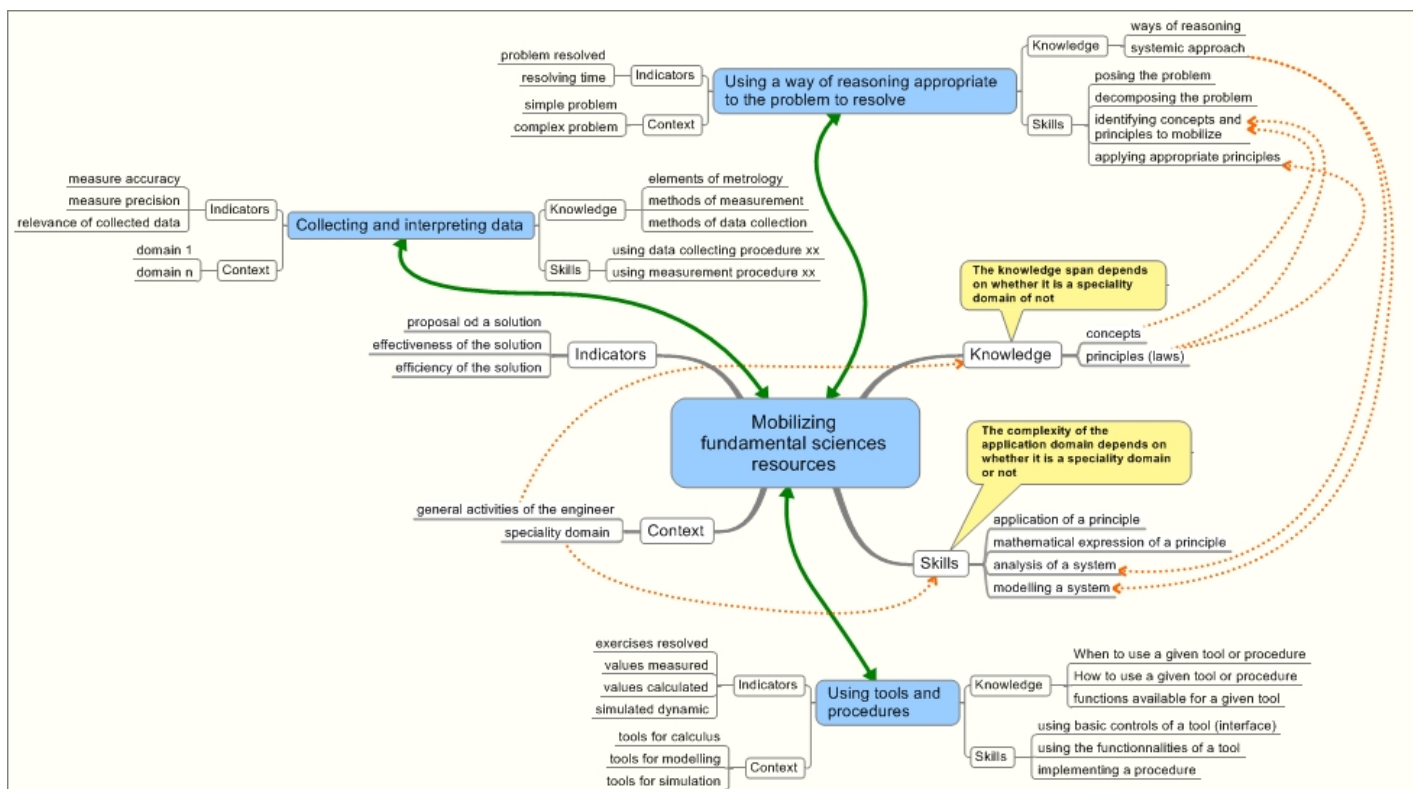


Figure 2: Our proposed competency framework for sciences

## PBL as a relevant approach to acquire the required competencies

Once the competency framework has been established and agreed, the question was “which instructional approach will allow our students to acquire and develop these competencies?” Problem-Based Learning<sup>2</sup>, which has been implemented in CESI’s School of Informatics, eXia, for several years (Sandel, Allard & Maufette, 2006) appeared as a good candidate.

Our experience in another domain (Informatics) revealed that PBL develops among our students the ability to identify and formulate a problem, and to set relevant parameters for the development of a solution. This is confirmed by Savery’s article as “*a critical skill developed through PBL*” (2006, p. 13). And this is precisely the main skills which are mobilized by the first “companion” competency in our competency framework, “Using a way of reasoning appropriate to the problem to resolve”.

Though PBL has not been much used in physics so far, it appears as having a great potential to align “teaching” and assessment when assessment means “assessment of competencies” and not only assessment of knowledge (Raine & Symons, 2005). This means, in other terms, that PBL is a good approach to acquire competencies.

The few experiments of PBL in physics which have been recently published provide contradictory results: for Sahin & Yorek (2009), there is no significant difference in terms of “expectations” and results between students having attended a traditional elementary course in physics and those having attended a PBL session; whereas for Ali & Rubani (2009), students

<sup>2</sup> Many books and articles have been published on PBL since Barrows and Tamblyn’s seminal book (Barrows & Tamblyn, 1980), and it is difficult to cite all these works here. A good synthesis on this instructional method is provided by Savery’s article introducing the first issue of the recent journal dedicated to this approach, *The Interdisciplinary Journal of Problem-based Learning* (Savery, 2006).

having attended a PBL session show improvements in team work, presentation skills, interpersonal communication and critical thinking.

A recent meta-analysis of researches on PBL concludes that sciences, in general, are a domain where PBL has not been proven as more efficient than other instructional methods (Walker & Leary, 2009). But Jonassen & Hung (2008) point out that “all problems are not equal”, and discuss the implications of such a statement for PBL. It appears, from this discussion, that efficiency of PBL is related to the problem used, and that a “good problem” should have the following characteristics:

- *“open ended, ill structured, however,*
  - o *with a moderate degree of structuredness;*
- *complex, however, the degree of complexity should*
  - o *be challenging and motivating, engaging students’ interests;*
  - o *provide opportunities for students to examine the problem from multiple perspectives or disciplines;*
  - o *adapted to students’ prior knowledge;*
  - o *adapted to students’ cognitive development and readiness;*
- *authentic*
  - o *contextualized as to students’ future or potential workplaces.”* (p. 16)

According to these authors, problems suitable for PBL should fall into one of the following categories: Diagnosis – Solution problems, Decision-making problems, Policy problems and Design problems (Jonassen & Hung, 2008).

The latter category, “Design problems”, perfectly fits with our objectives and our competency framework, and it allows our students to learn and apply a wide range of scientific concepts and principles to solve them. So, adoption of PBL was agreed.

But according to Jonassen & Hung (2008) we need to be careful: Design problems require “*more time for scoping the problem and gathering information*”, and if we want to make sure that our students have acquired the right concepts and principles (and not “alternative” conceptions or ways of reasoning, we also have to take into account one of Savery’s recommendations: “*A closing analysis of what has been learned from work with the problem and a discussion of what concepts and principles have been learned are essential. Given that PBL is a very engaging, motivating and involving form of experiential learning, learners are often very close to the immediate details of the problem and the proposed solution. The purpose of the post-experience debriefing process [...] is to consolidate the learning and ensure that the experience has been reflected upon.*” (Savery, 2006, p. 14). The importance of debriefing to consolidate learning outcomes of any experience-based learning situation is also confirmed by many research works in the field of “*Didactique professionnelle*”<sup>3</sup>, and in particular by Pastré (2004; 2006).

## **An overview of the design process for the curriculum**

Our competency framework for sciences and the intention to use “Design problems” to develop a Problem-Based Learning curriculum were the basic inputs to the design process for the new curriculum.

---

<sup>3</sup> This field of research has developed in France for more than 20 years to understand experience-based learning, particularly in work contexts. There are many publications in French. A good overview of this field of research is given by the following papers from Vergnaud (1992; 2004) and Pastré (2004; 2006; 2008).

The experimental curriculum should replace the traditional course, and allow the students to pass the same exams: it must be compliant with the traditional course programme, and allow learning the same concepts, the same principle, and learning when and how to apply them.

So, to be able to compare the traditional course programme and the new curriculum, we had to identify at a very detailed level the elements of the core competency acquired through the traditional course, which means to identify the abilities, the resources (knowledge, skills) mobilized and their contexts, i.e. the application fields. To achieve this, a teacher of the research group was asked to provide a detailed list of the learning objectives for the traditional course. These learning objectives were then translated into competency elements, allowing a very detailed description of the two parts of the curriculum (revision and course): each competency element is described within a context of application, with the associated concepts and principles which should be mastered, the associated tools including mathematical expressions that should be used, etc. An example is given below (Table 1)

Competency element	Domain of application	Concepts	Principles	Tools
Establishing the kinematics of oscillating systems	A system composed of a solid and a spring (no friction)	Back-moving force	Newton's second law	Equation of oscillatory motion
	A system composed of a solid and a spring (with friction)	Back-moving force, Friction		
	Sustained oscillation	Sustained oscillation, Exciter	Fundamental mode of vibration	Modelling / simulation tools

Table 1: Example of a detailed part of the competency-based description of the curriculum

In all, we determine 8 elements of the core competency which should be mastered, evidence being given through 24 fields of application during the revision part, and 6 elements of the core competency to acquire through 42 fields of application for the second part of the curriculum. The most important element of the core competency acquired during the course is “Analysing a mechanical system” which requires 20 different fields of application.

The list of these elements of the core competency was then circulated to the other teachers of the experimental group, and also to some others, for comments. The few comments provided were taken into account in the final version of the list, which will be used to design the PBL situations and to check their covering of the programme.

The second step was the design of the problems which will be used. The first problem was conceived and designed with the help of a PBL tutor from eXia, CESI School of Informatics, well-trained in the PBL approach and in Problem design, and who is himself an engineer. Then, after this first trial, a list of problems covering the curriculum has been established.

This first problem aims at giving evidences that basic concepts (such as velocity, acceleration, force, mass, weight, kinetics energy, potential energy...) and principles of Newtonian Physics are applied correctly. It covers 7 out of 8 of the core competency elements, and 20 out of 24 applications fields for the revision part of the course (power and concepts related to rotational / circular motion such as torque or momentum are not covered by this first problem). The results of the FCI test will help identify students having difficulties with these concepts and principles. The problem is introduced by a letter from a railway engineer to a friend who is physicist: *“I anticipate potential problems with our hump yard, and I fear that our new wagons rush down the hump with a final velocity much too high for our points, and end their course with too much energy for our buffers. According to what I remind from my courses in*

*physics, this sort of things is calculable. We have a budget to buy new car retarders. Can you help me to dimension them?"*

The resources available to solve this problem are: a website explaining what is, and the different types of marshalling yards, including the hump yard; a video on internet showing the functioning of the hump yard; a document providing information about the hump yard, including its plan and profile (Fig. 3); the characteristics of different types of wagons; the characteristics of the bumpers and of car retarders (brakes)...

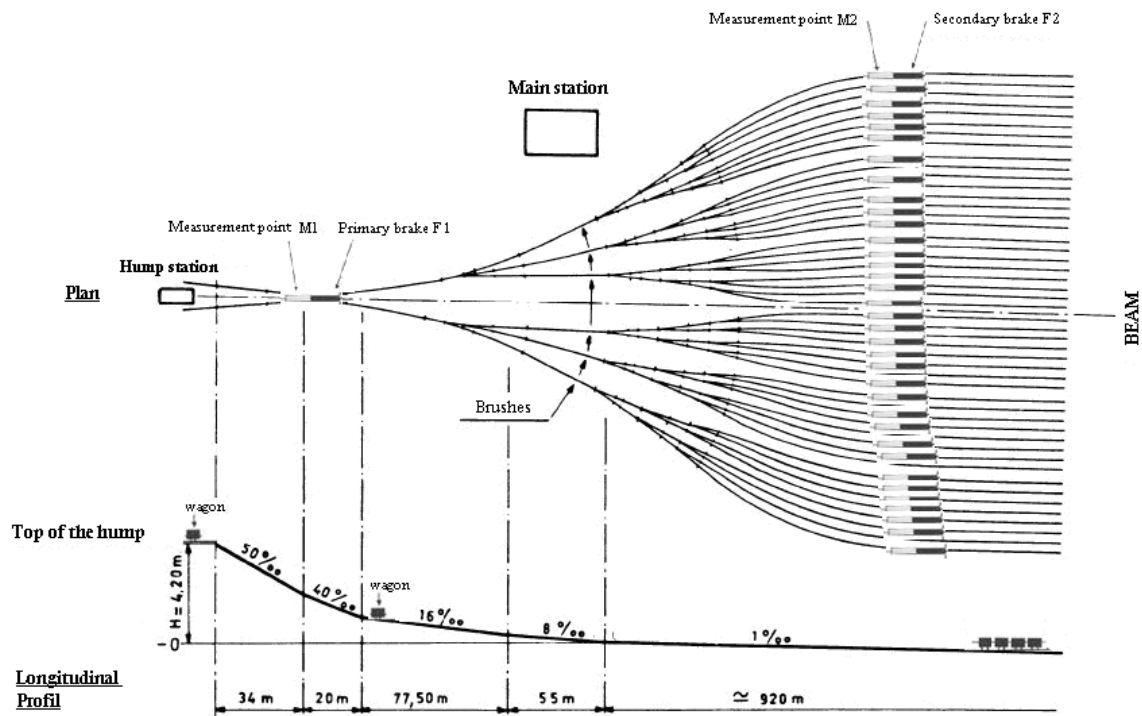


Figure 3: An example of resources for the Hump Yard Problem

For each problem, a good practice in eXia, which we decided to adopt, is that the authors develop a Tutor's Guide, which is enriched after every session in order to take into account tutors remarks, tricks and proposed improvements, and this has been done.

The second problem of the revision part intends to cover the elements of the core competency and the application fields which are not covered by the hump yard problem (power and rotational). It deals with the calculation of the efficiency of the brakes of a bicycle requested by an insurance company before an amateur cycling tour in the Alps.

The rest of the course will be replaced by 4 problems:

- Provide the characteristics of a new fastening system for a baby seat in a car resisting to a 60 mph frontal shock with a baby weighting 10kg.
- Provide the characteristics of a gear motor able to open in less than 1mn a large vertically-opening fire hall door with given characteristics.
- Calculate the length of the rotor blades for a helicopter having given characteristics.
- Explain why an amusement device crashes.

These 4 problems cover all the elements of competency and all the application fields of the second part of the course.

This is where we are at the moment of this presentation: the problems are conceived and designed, some resources need to be produced, and the problems are to be validated against the detailed list of core competency elements and application domains.

### **The next steps**

One important step which will take place in September is training the teachers who will participate in delivering the experimental PBL curriculum to become PBL tutors. Though highly involved in the project since the beginning, when working with their colleague from eXia, they feel the necessity to attend, as observers, a PBL session in the School of Informatics, and then they asked for being trained as tutors. The main reason is that they discovered that students starting PBL are generally lacking of “*cognitive self-monitoring and self-regulation*” (Savery, 2006, p. 15), as their colleagues from eXia experienced it, and therefore students “*require significant instructional scaffolding to support the development of problem-solving skills, self-directed learning skills, and teamwork/collaboration skills to a level of self-sufficiency where the scaffolds can be removed*” (d°). This appears to be crucial for the project, especially since our students will have at the same time traditional courses in other disciplines, which is an instructional form they might prefer because they are used to it and because it requires less effort from them!

Prior to starting the experimentation of the new curriculum, as said in the introduction, all the students of the school will take the FCI test, and all the 2<sup>nd</sup> and 3<sup>rd</sup> year students will also take the MBT test. These tests have been ported onto our LMS, which is based on Moodle, and we still have to organise the test-taking in our 12 centres for October 2<sup>nd</sup> and 3<sup>rd</sup> year) and November (1<sup>st</sup> year).

And then, we will start the experimentation. Between November 2010 and February 2011, 1<sup>st</sup> year students will follow the first part of the course in Mechanics. About 100 of them will follow the new curriculum and the rest will attend the traditional course. Then, they will all take the FCI test for the second time, followed by the MBT test. Between March 2011 and June 2011, they will follow the second part of the course, with the same distribution between the experimental course and the traditional one. At the end, they will take again the MBT test. In July 2011, we will analyse the effects of the experimental curriculum, by processing the results to the FCI and the MBT tests, and comparing them with the results obtained after the traditional course. But this is another story, which will be reported in a future presentation.

### **References**

- Ali, A.H. & Rubani, S.N.K. (2009) Student-centred Learning: An Approach in Physics Learning Style using PBL Method. Available online at the following URL, accessed on 2010/08/16: [http://eprints.uthm.edu.my/294/1/ahmad\\_hadi\\_ali\\_ICTLHE.pdf](http://eprints.uthm.edu.my/294/1/ahmad_hadi_ali_ICTLHE.pdf)
- Barrows, H. S. & Tamblyn, R. M. (1980), *Problem based learning: an approach to medical education*, (New York, Springer).
- Closset J.L. (1983). *Le raisonnement séquentiel en électrocinétique*. Thèse de troisième cycle, Université Paris 7-LD.P.E.S.
- Closset J.L. (1992). Raisonnements en électricité et en électrodynamique. *Aster*, 14, pp. 143-155.
- Hestenes, D. Wells, M. & Swackhamer, G. (1992) Force Concept Inventory, in *The Physics Teacher*, Vol. 30, March 1992, 141-158
- Hestenes, D. Wells, M. (1992) A Mechanics Baseline Test, in *The Physics Teacher*, Vol. 30, March 1992, p. 159-166.
- Horton, C (2007) Student Alternative Conceptions in Chemistry , in *California Journal of Science Education*, Volume VII, Issue 2 – Spring, 2007

- Jonassen D.H. & Hung W. (2008) All Problems are not equal: Implications for Problem-Based Learning, in *The Interdisciplinary Journal of Problem-based Learning*, volume 2, no. 2 (Fall 2008), p. 6-28
- NSF (2006) *Revolutionizing Engineering Science through Simulation*. Report of the National Science Foundation Blue Ribbon Panel on Simulation-Based Engineering Science. Available online at the following URL: [http://www.nsf.gov/pubs/reports/sbes\\_final\\_report.pdf](http://www.nsf.gov/pubs/reports/sbes_final_report.pdf), accessed on 2010/08/16.
- OECD & Global Science Forum (2006) *Evolution of Student Interest in Science and Technology Studies – Policy Report*. Available online at the following URL, accessed on 2010/08/16: <http://www.oecd.org/dataoecd/16/30/36645825.pdf>
- Pastré, P. (2008) La didactique professionnelle : origine, fondements et perspectives, in *Travail et apprentissage n°1*, pp. 9-21
- Pastré, P. (2006) Apprendre à faire, in BOURGEOIS, E. & CHAPPELLE, G. *Apprendre et faire apprendre*. Paris : PUF, p. 109-121.
- Pastré, P. (2004) L'ingénierie didactique professionnelle, in CARRE, P. & CASPAR, P. (dir.) *Traité des sciences et techniques de la formation*. 2<sup>e</sup> édition. Paris : Dunod, p 465-480.
- Raine, D. & Symons, S. (2005) Experience of PBL in Physics in UK Higher Education, in Esa Poikela & Sari Poikela (eds.) *PBL in Context – Bridging Work and Education*. Tampere (FI): Tampere University Press, p. 67-78.
- Rozier S. (1988). *Le raisonnement linéaire causal en thermodynamique classique élémentaire*. Thèse, Université Paris 7-L.D.P.E.S
- Sahin, M. & Yorek, N. (2009) A comparison of problem-based learning and traditional lecture students' expectations and course grades in an introductory physics classroom, in *Scientific Research and Essay* Vol.4 (8), August, 2009, pp. 753-762
- Sandel, O. Allard, J.-L. Maufette, Y. (2006) Effets d'une formation par l'APP sur l'insertion en entreprise : évaluation et enseignements des stages de l'eXia, in Frenay, M. Raucant, B. & Wouters, P. *Actes du 4<sup>e</sup> colloque Questions de pédagogie dans l'enseignement supérieur – Les pédagogies actives : enjeux et conditions*. Louvain-la-Neuve (24-26 janvier 2007), p. 219-228.
- Savery, J.R. (2006) Overview of Problem-based Learning: Definitions and Distinctions, in *The Interdisciplinary Journal of Problem-based Learning*, volume 1, no. 1 (Spring 2006), p. 9-20
- Vergnaud, G. (1992) Qu'est-ce que la didactique ? En quoi peut-elle intéresser la formation des adultes peu qualifiés ? in *Approches didactiques en formation d'adultes, Education Permanente n°111*, p. 19-31.
- Vergnaud, G. (2004) Le développement cognitif de l'adulte, in CARRE, P. & CASPAR, P. (dir.) *Traité des sciences et techniques de la formation*. 2<sup>e</sup> édition. Paris : Dunod, p 219-233.
- Viennot L. (1979). *Le raisonnement spontané en dynamique élémentaire*. Paris, Hermann.
- Viennot L. (1992). Raisonnement à plusieurs variables : tendances de la pensée commune. *Aster*, 14, pp. 127-141
- Walker, A. Leary, H. (2009) A Problem Based Learning Meta Analysis: Differences Across Problem Types, Implementation Types, Disciplines, and Assessment Levels, in *The Interdisciplinary Journal of Problem-based Learning*, volume 3, no. 1, pp. 12-43.
- WTEC (2009) *International Assessment of Research and Development in Simulation-Based Engineering and Science*. Available online at the following URL, accessed on 2010/08/16: <http://www.wtec.org/sbes/SBES-GlobalFinalReport.pdf>

Viennot L. (1992). Raisonnement à plusieurs variables : tendances de la pensée commune. *Aster*, 14, pp. 127-141

Walker, A. Leary, H. (2009) A Problem Based Learning Meta Analysis: Differences Across Problem Types, Implementation Types, Disciplines, and Assessment Levels, in *The Interdisciplinary Journal of Problem-based Learning*, volume 3, no. 1, pp. 12-43.

WTEC (2009) *International Assessment of Research and Development in Simulation-Based Engineering and Science*. Available online at the following URL, accessed on 2010/08/16: <http://www.wtec.org/sbes/SBES-GlobalFinalReport.pdf>



# A Hybrid-Online Course in Introductory Physics

Homeyra R. Sadaghiani

California State Polytechnic University, Pomona, USA

hrsadaghiani@csupomona.edu

## INTRODUCTION

The recent demand and interest in developing online and hybrid courses in both public and private institutions of higher education has intensified in recent years [1]. For the university, the benefits of online and hybrid courses include reduced costs and increased ease of disseminating courses. For students, these types of courses mean more distance learning opportunities, convenience, and flexibilities. As an educator and researcher, my goal is to improve student learning by continuously refining both the content and associated pedagogy of the physics courses. To this end, my objective in this project is to collect and analyze data in order to compare the learning, attitudes, and experiences of students in a hybrid physics course with the traditional face-to-face format.

It is increasingly difficult for traditional teaching techniques to capture and maintain student interest because new generations have grown up in such a digitally advanced era. Many educators consider multimedia technology as a useful teaching tool that can attain the attention of today's students. Multimedia combines voice, animations, and words to create a more dynamic representation of course material. In the past decade, the field of multimedia learning has emerged as a coherent discipline with a great deal of research at its base. Research shows that students can benefit from technology-enhanced learning supplements that unify concepts and are delivered on-demand over the Internet [2], [3].

We have implemented multimedia rich online course material, developed by University of Illinois at Urbana Champaign (UIUC) Physics Education Research (PER) group, in teaching introductory calculus-based electricity and magnetism at California State Polytechnic University in Pomona (CPP). In this paper, we will discuss details of a control study that was designed to investigate the effectiveness of the material on student learning and achievement in context of a hybrid-online course.

## MULTIMEDIA LEARNING MODULES (MLM)

Multimedia Learning Modules (MLM) are combinations of various media within a single computer program streamed online. These 12-15 minutes modules are research-based presentations and learning activities designed to introduce the key course concepts through flash animations with synchronous narration. **Figure 1** demonstrates a screenshot



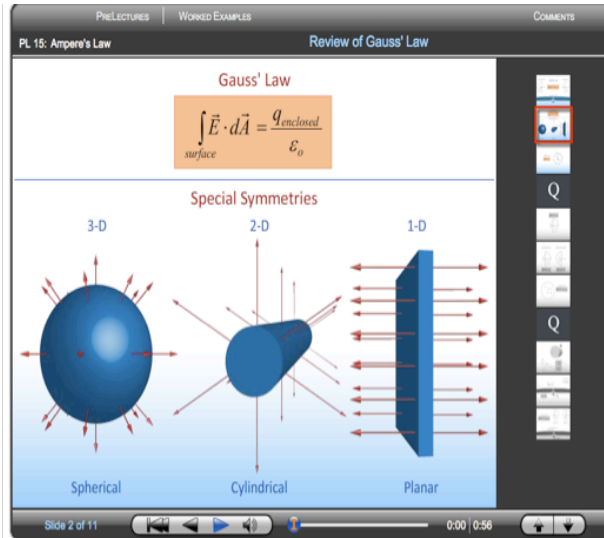
of the Ampere's Law MLM [4]. Each module has two or three questions that are embedded into the content itself. Students must answer the questions correctly in order to proceed. Automatic feedback and related prompts guide students in determining the correct answers to these questions. Students view the material as prelectures before attending each class meeting.

In designing Multimedia Learning Modules, the content is guided by findings of physics education research, and presentations of the content are based on principles of multimedia learning. Research suggests that the use of dual learning channels (audio and visual) improves student learning [5]. Thus, by utilizing both auditory and visual channels to assimilate information, multimedia maximizes students' short-term memory. By focusing on the principles of multimedia [6] and how people learn from words and pictures in computer-based environments, the MLM coordinates the animations with narration to enhance learning outcomes.

## METHODOLOGY

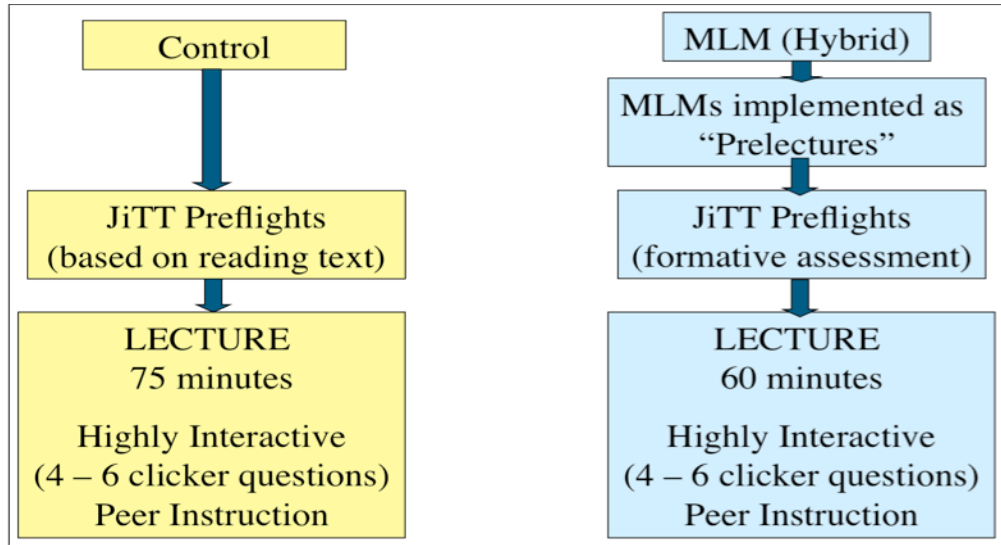
We started piloting the online MLM prelectures in Fall 2008 by implementing three modules into a third quarter of introductory calculus-based electricity and magnetism course (PHY 133) for engineering and physics majors at CPP. Later, in Spring 2009 we designed a control study to investigate the effectiveness of the online prelectures in student learning, achievement, and preparation for class discussions. Students in one section of PHY 133 served as the Control group (face to face or a traditional format) while a second section was offered via a hybrid format using MLM as prelectures. Both classes met twice a week. The traditional class met 75 minutes each period while the hybrid class met for 50 minutes and the remaining 25 minutes (one-third of the class time) was offered to students in an online format through the use of Multimedia Learning Modules. Students were required to view the MLM before each face-to-face class meeting. **Figure 2** illustrates the schematic layout of the research study. Here we will discuss the impact the multimedia prelectures had on student performance before class, in the classroom, and on nationally known conceptual tests.

Thirty-four students were enrolled in the Hybrid course and forty-eight in the Control group. The two classes were very similar in their background as measured by the survey. For example, the average GPA for the Hybrid class was 3.0 compared to 2.9 for the



**Figure 1-** Screenshot of the online multimedia prelecture on Ampere's Law in electromagnetism.

Control group, and the percentage of students receiving grades “A”, “B”, and “C” in their previous physics course (PHY 131, Mechanics) was also comparable.



**Figure 1.** A schematic representation of the control study design.

## DATA COLLECTION

We have collected a variety of data across both sections to compare student performance in the two courses. For example, we used a nationally known electricity and magnetism conceptual survey. We then collected data on student responses to identical clicker questions during the lecture, and collected survey data on usefulness of different course component from both groups. Below, we will discuss each data set and in more detail.

### I. Conceptual Survey:

Using the Concept Survey of Electricity and Magnetism (CSEM) [7], we measured student conceptual understanding of the topics presented in this course. The CSEM is a 32-item, multiple-choice instrument of understanding of subjects covered in a typical introductory electricity and magnetism course. CSEM was used as both a pretest (first week of the quarter) and as a post-test (last week of the quarter). In order to compare the results across both sections, we calculated the normalized gain  $\langle g \rangle$  for the students in the two classes where  $\langle g \rangle$  is the ratio of the actual to the maximum possible:

$$\langle g \rangle = \frac{(posttest - pretest)\%}{(100 - pretest)\%} \quad (1)$$

No incentives were offered to students for taking the survey and we noted that students’ responses on the survey would not affect their course grade in any way. We only included the data for students who completed both pre and post-test surveys. We gave students in both groups only thirty minutes to complete the pre and post-tests. However, thirty minutes was not sufficient; therefore, we only included the questions that majority of the students had completed which was up to question number 25. Most of these

Courses	Pretest	Post-test	<g>
Hybrid (N=29)	24% + 4%	58% + 4%	45%+ 4%
Control (N=40)	27%+ 3%	54%+ 3%	37%+ 3%

**Table 1.** The pre/post and normalized gain on CSEM.

questions focus on electricity and not all the questions regarding magnetism were included in the analysis of the scores. The results of the student performance in CSEM are summarized in **Table 1**.

The pretest data was slightly lower for the Hybrid group compared to the Control (24% vs. 27%). However, the Hybrid group outperformed the Control group in the post-test resulting in 8% higher normalized gain (45% vs. 37%). As for comparing the data to published data, [see ref 7] typical pretest scores are 31% (calculus-based) and 25% (algebra-based); post-test data only rise to 47% and 44% respectively. Data was collected for over 5000 students at 30 different schools. However, since our results do not include the entire 32 items on CSEM, there is no good means for comparison.

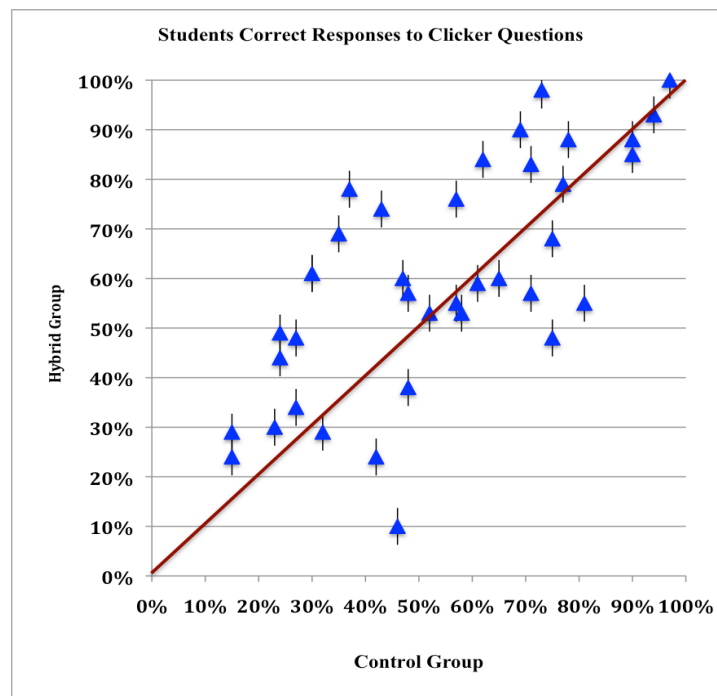
## II. Clickers questions and class discussion

Clickers are hand-held devices similar to the remote controls which can send a specific electronic signal (e.g., radio frequency) to a central receiving station connected to a computer equipped with software that tabulates the responses and displays the distribution of answers on a bar graph on the screen. Often the instructor poses a multiple choice or true/false question. These questions can be content questions asking for recall of information, conceptual questions seeking evidence of understanding, application questions, critical thinking questions, synthesize questions, or problem solving questions. Students respond by pushing buttons for answers (a), (b), (c), and so on. Then, the instructor displays the bar graph of student responses which in turn provides an immediate feedback to students on where they stand in terms of how well they understand the material, and where they stand in relation to their peers.

Along with clickers, we also used the think-pair-share from the Peer Instruction [8] method and asked students to talk to their neighbors in class before voting. We compared student correct responses to thirty-six identical clicker questions on relevant topics of lecture and textbook reading. The average percentage of the correct answers in the Hybrid class was (60.3+4.0)% while this number for the Control group was (53.8+3.3)%. The graphical representation of the data is shown in **Figure 3**. This difference in means leads to a small Effect Size (ES) of 0.27; where ES is a statistical concept that measures the strength of the relationship between the two variables. The ES can be calculated by dividing the two population mean differences  $\bar{\mu}_1$  and  $\bar{\mu}_2$  by their standard deviation  $\sigma$ :

$$ES = \frac{\bar{\mu}_1 - \bar{\mu}_2}{\sigma}$$

The small value of the ES (0.2) corresponds to a small effect, 0.5 is considered a medium effect, and 0.8 and greater reflect a large effect size.

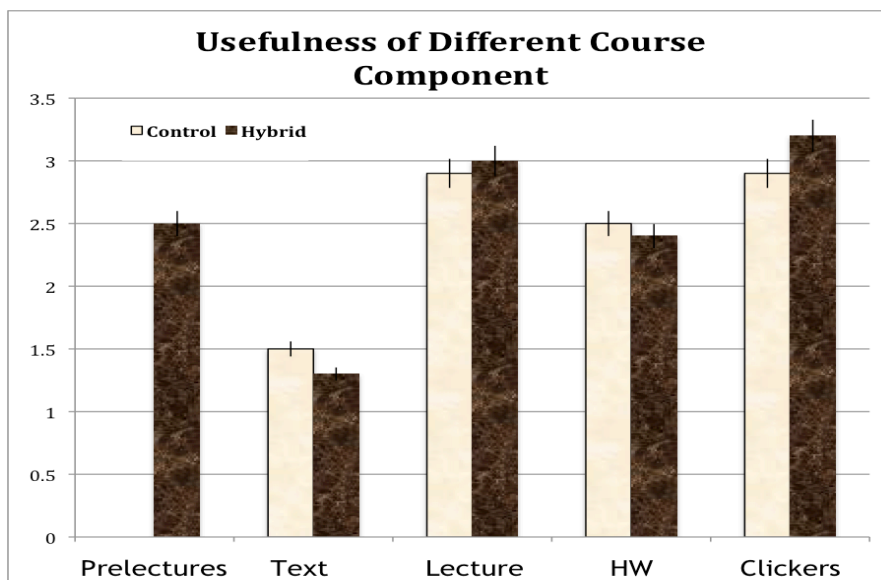


**Figure 3.** Student responses to identical clicker questions in Control and Hybrid classes

### III. Student feedback:

In addition to collecting class discussion data via clickers and the CSEM concept test, at the end of the quarter we administered a survey designed to elicit specific feedback on student attitude and experience with the MLM and with the hybrid-online course delivery format. This survey comprised of multiple-choice, ranking scales, and open-ended questions. Among other questions, we asked students in both classes to rank the usefulness of different course components in their learning in the scale 1 to 5 (1 = not useful at all, 5 = very useful). The result of student responses to this question is represented in a bar graph in **Figure 4**.

The textbook was ranked the lowest in both classes; many students stated that they do not find the textbook useful in their learning. Student average ranking of the prelectures was much higher than the textbook. The average ranking of the lecture and clicker usefulness by students in the Hybrid class was slightly higher than the Control group, indicating that the view of MLM did not diminished their interest in class discussion and interaction. In fact, students in the Hybrid class seem to be more engaged with the questions and discussions than the Control group; perhaps due to some prior preparation via MLMs.



**Figure 4.** Student ranking of different course component in 5-scale survey

## DISCUSSION

We have conducted an experiment to evaluate the effectiveness of using MLM prelectures in teaching Electricity and Magnetism course at CPP. Our data indicated that overall introduction of MLM prelectures as an online component of the hybrid course had positive impact on the course. First, students showed a larger conceptual gain, measured by SCEM, in the class where MLM were utilized. Secondly, students who viewed MLM outperformed the Control group in class discussion and clicker questions. Finally, students believed that MLM helped them learn better and was ranked more useful than the course textbook.

It is important to note that this study does not promote online courses, rather demands higher quality, better learning outcomes, and increased student engagement for online course material. One can argue that traditional, face-to-face teaching is always better. However, the development of technology and amplified use of computers will bring more and more online courses upon us. Online enrollments have grown much faster than overall higher-education enrollments over the past few years. During the period 2002-2007, enrollment in online courses grew 19.7%, compared with 1.5% growth in the overall college-student population. [see ref 1] These numbers suggest tremendous interest in online teaching and learning and the possible increase on the number of online courses that will be offered in near future.

The Internet provides a platform for learning about and interacting with the world which higher education could employ as an educational tool. It is economical, flexible, convenient, and more importantly it is an integral part of our students' lives. Thus, as educators and researchers we should be concerned and involved with the quality and delivery of the online course material and use the results of research to demand higher quality and excellence.

## REFERENCES

- [1] "Staying the Course: Online Education in the United States," published by the Sloan-C, 2008 report.
- [2] "*e-Learning and the Science of Instruction: Proven Guidelines for Consumers and Designers of Multimedia Learning*," Ruth Colvin Clark & Richard E. Mayer, Wiley, 2008.
- [3] Richard E. Mayer, "Multimedia learning: Are we asking the right questions?" *Educational Psychologist*, Vol. 32, 1997. "*The Cambridge handbook of multimedia Learning*," Edited by Richard E. Mayer, Cambridge University Press, 2005.
- [4] Full MLM modules can be viewed at:  
[https://online-s.physics.uiuc.edu/courses/phys212/gtm/No\\_Login/page.html](https://online-s.physics.uiuc.edu/courses/phys212/gtm/No_Login/page.html)
- [5] A. Baddeley et al. "Dementia and Working Memory," *The Quarterly Journal of Experimental Psychology*, V. 38, Issue 4, Pages 603 – 618, 1986. John Sweller, "Cognitive load theory, learning difficulty, and instructional design," *Learning and Instruction*, Vol.4, 1994.
- [6] R. Moreno et al. "Cognitive principles of multimedia learning: The role of modality and contiguity," *Journal of educational*, Vol 91, 1999. "*Multimedia learning*," By Richard E. Mayer, Cambridge University Press, 2009.
- [7] D. Maloney, T. O’Kuma, C. Hieggelke, and A. Van Heuvelen, "Surveying students’ conceptual knowledge of electricity and magnetism," *American Journal of Physics*, Vol. 69, 2001.
- [8] Eric Mazure et al., "Peer Instruction," *American Journal of Physics*, Vol. 67, 1999. CH Crouch, E Mazur "Peer instruction: Ten years of experience and results," *American Journal of Physics*, Vol. 69, 2001

# A Student-Centered Active Learning Environment for Introductory Physics

Gerald Feldman (feldman@gwu.edu) and Larry Medsker (lrm@gwu.edu)  
Department of Physics  
George Washington University  
Washington, DC 20052 USA

Nawal Benmouna (nawal.benmouna@montgomerycollege.edu)  
Department of Physics, Engineering and Geosciences  
Montgomery College  
Rockville, MD 20850 USA

## I. Introduction

Studies of undergraduate science education have shown that students need to be actively engaged in the learning process in order for it to be effective. Passive lecturing (“teaching by telling”) is known to be ineffective in developing students’ skills in critical thinking [1]. One of the first collaborative group-learning environments (“studio physics”) was developed by Wilson [2] in the mid-1990’s to address this issue — students worked together in small groups and the instructor served as a facilitator or “coach” instead of a lecturer. A critical aspect of the studio approach is the integration of laboratory activities into the classroom — in this manner, class time is filled with a seamless progression of activities, ranging from group problem-solving exercises to lab experiments to short demonstrations to mini-lectures. By merging the collaborative approach with the integration of various pedagogical activities, a dynamic collective learning environment is created.

A practical limitation of the studio method is the small class size — it is simply not possible to staff multiple sections of a course with limited faculty resources. Beichner at North Carolina State University has pioneered an extension of the studio approach, called SCALE-UP (Student-Centered Active Learning Environment for Undergraduate Programs), which adapts the method for larger class sizes (*e.g.*, up to 99 students) [3]. In this scheme, round tables accommodate 3 groups of 3 students (9 students per table) for all classroom activities. For a class of this size, one instructor and two Teaching Assistants are sufficient to handle the questions and to promote useful discussions among the students.

The SCALE-UP pedagogy has several basic characteristics: active learning, collaborative groups, integrated lecture/laboratory and technology assistance. In a SCALE-UP classroom, there is minimal lecturing in the conventional sense. The students are expected to prepare for class by reading the textbook in advance, and then most of the class time is spent enriching the material by engaging the students in a variety of hands-on and “minds-on” activities. In that regard, the activities are built around three fundamental pillars: (1) *ponderables* are problems to think about, both numerical and conceptual, that students work on together in their groups with portable white boards, (2) *tangibles* are hands-on activities, ranging from short 5-minute demonstrations to more lengthy laboratory experiments, and (3) *computer simulations* that help the students model physical trends and behavior, usually done using the VPython language [4].

There are over 50 institutions in the United States that have adopted the SCALE-UP pedagogy, and at present there are at least a dozen institutions in other countries implementing this approach as well. The SCALE-UP web site at North Carolina State University has a wealth of information about this collaborative approach and the results at various institutions [5].

## II. Implementation

We have implemented the SCALE-UP approach at George Washington University (GWU) for our calculus-based introductory physics class and the first semester of our algebra-based class. We have redesigned a classroom with 6 round tables, able to accommodate a total of 54 students. Each group of 3 students shares a laptop computer and has a portable white board to facilitate their work together. The classroom walls have large white boards on which students can display their work, 4 large LCD screens for image projection, and storage cabinets for lab equipment. For a room of this size, one instructor and one Teaching Assistant can provide sufficient coverage for all students. A schematic drawing of our SCALE-UP classroom is shown in Fig. 1 below.

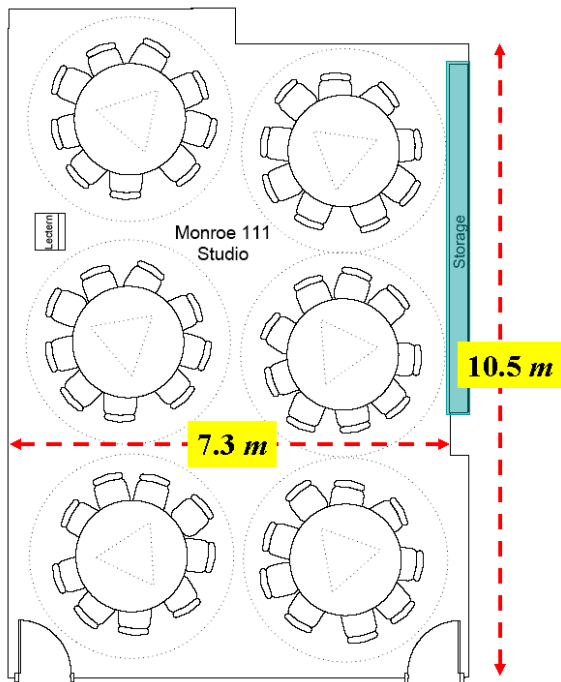


Fig. 1: Schematic view of the SCALE-UP classroom. The instructor station is mobile and can be located anywhere in the room. The storage cabinets for equipment and laptop computers are located on the right-hand wall.

We instituted SCALE-UP in Spring 2008, and at this point, we now have 5 semesters of experience. While most of our efforts have focused on the introductory calculus-based class that is typically taken by science majors and engineers (Phys 21 and 22), we have also tried out the collaborative approach in our algebra-based physics course (Phys 11) and also our astronomy class (Astr 1). A timeline of the development of SCALE-UP at our institution is given below:

- Spring 2008 – calculus-based Phys 21 and Phys 21 (bio-focused)
- Fall 2008 – calculus-based Phys 21, algebra-based Astr 1
- Spring 2009 – calculus-based Phys 21, Phys 22 and Phys 21 (bio-focused)
- Fall 2009 – calculus-based Phys 21
- Spring 2010 – calculus-based Phys 21 and Phys 22, and algebra-based Phys 11
- Fall 2010 – calculus-based Phys 21 and Phys 22, and algebra-based Astr 1

In our “usual” configuration, the class meets 3 times a week — 2 hours on Monday and Wednesday and 1 hour on Friday — with a weekly 15-minute quiz every Friday. Groups are carefully arranged by the instructor, and guidelines are clearly outlined in a “group contract” that is



prepared by each group. The group assignments are switched at the mid-point of the academic semester — that is, the students are reorganized into different groups so as to keep the group interactions fresh and vigorous. In class, students work collaboratively on conceptual questions and numerical problems (*ponderables*) using their portable white boards, in addition to short hands-on activities and longer laboratory experiments (*tangibles*) using real-time data acquisition. It is necessary to point out that so far we have not yet included the computer simulations using VPython, primarily due to lack of time.

Homeworks are delivered via a web-based online system called *MasteringPhysics* [6] which is available through Pearson Higher Education, who is the publisher of the textbook that we use (*Physics for Scientists and Engineers: A Strategic Approach* by Randall Knight [7]). We typically assign 14 problems per week, with an additional 2 problems being available for extra credit. These assignments generally take about 3-4 hours to complete. Since lecture is reduced to a minimum, class preparation is an important consideration for students. To gauge their understanding and to motivate their preparation for class, pre-class “Warmups” are available online for students, also through the *MasteringPhysics* system. These consist mostly of about 10 multiple-choice conceptual questions related to the material to be covered in class on that day. The “Warmups” are expected to require about 30-40 minutes for completion and are presented to the students twice a week, before the Monday and Wednesday two-hour classes.

Tangibles are highly beneficial, and it is often a challenge to devise short demonstration exercises that take only 10 minutes or so. One example of a simple tangible is to drop a meter stick between the fingers of a student (see Fig. 2) to measure her reaction time using free fall. The distance that the meter stick falls before the student catches it can be converted into a time interval which is a rough estimate of the student’s ability to react to the dropped meter stick.



Fig. 2: Example of a “tangible” to measure human reaction time. By dropping the meter stick from a fixed position, the time needed to catch the falling stick can be deduced by a direct measurement of the free-fall distance.

Another tangible actually begins with a ponderable, in which students calculate the angle at which a rough surface must be tilted in order to make a metallic block overcome static friction and slide down the plane. This exercise yields the usual  $\mu_s = \tan \theta$  result with which we are all familiar. After the calculation, the students try the exercise themselves, using the rough cardboard backing of their own white boards as the inclined plane. Each group member takes a turn slowly tilting the white board until the metal block just begins to slide — then the other group members take length measurements that enable them to determine the angle of the board. After all three group members have tried this, the measurements are averaged and an overall average value of  $\mu_s$

is obtained. While the actual answer is unknown, the fact that 75% of the groups come up with a value within  $\pm 10\%$  of  $\mu_s = 0.35$  seems convincing that a consensus value has been reached.

Laboratory experiments also fall into the category of tangibles. For our real-time data acquisition, we use probes and software from Vernier [8]. While these exercises are not so different from a conventional lecture/lab course, the guidelines for conducting the experiments are “streamlined” to leave the exercise a bit more open-ended. Some of the experiments conducted in our SCALE-UP class include:

- using motion sensors to measure the acceleration of carts on an inclined plane (along with video analysis of similar motion)
- using motion sensors to analyze elastic and inelastic collisions of carts (along with video analysis of similar motion)
- measuring the moment of inertia of a uniform cylinder by wrapping it with a string attached to a mass and letting the mass fall, unwinding the string as it falls
- determining the mass of an automobile by measuring tire pressure and contact area
- determining the density of air by floating helium balloons
- measuring the specific heat of an unknown metal sample
- investigating the “coffee and cream” problem to ascertain whether cool cream should be added to hot coffee right away or after a waiting period

It is important for the students to have a means by which they can gauge their overall progress at regular intervals. Since homework assignments are often collaborative efforts (it is entirely acceptable and even encouraged for students to help each other in these assignments) and since exams are too infrequent and are often high-stakes (and high-stress) events, we have opted to give a quiz every Friday at the beginning of our one-hour class. The quiz lasts 15 minutes and contains one conceptual and one numerical problem (possibly with multiple parts). The main idea is to simulate an exam-like environment so that the students can get a sense of how they are doing on a weekly basis, thus enabling them to take the necessary steps if they feel that they are struggling with the conceptual or the problem-solving aspects of the course. The Friday quizzes have proven to be an excellent predictor of exam performance, as evidenced by the plots shown below in Fig. 3 from the Spring 2008 and Spring 2009 semesters.

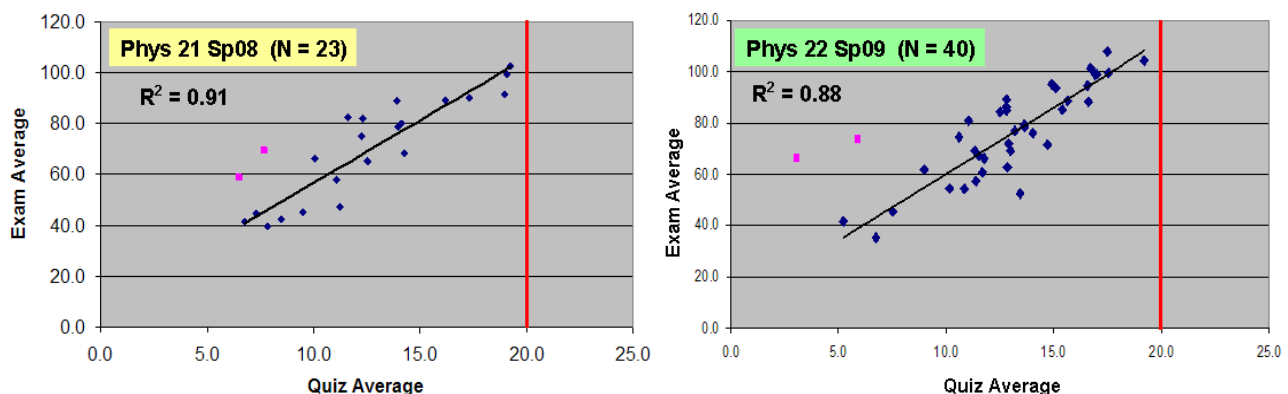


Fig. 3: Correlation between quiz grades and exam grades in the Phys 21 and Phys 22 classes. The maximum score on each weekly quiz is 20 points (indicated by the red marker). The pink data points were omitted from the linear fit, due to a large number of quiz absences for those students.

### III. Results

We have several semesters of data for the Phys 21 class to assess the effectiveness of the SCALE-UP pedagogy at GWU. We have acquired data on the Force Concept Inventory (FCI) [9], as well as the Colorado Learning Attitudes about Science Survey (CLASS) [10] to examine student attitudes. In the first semester of our SCALE-UP deployment (Spring 2008), we had a large (concurrent) conventional lecture section take the same assessments for comparison purposes, including common in-class exams. The results of the in-class exams are shown in the table below.

	Exam #1	Exam #2	Final Exam
<b>Standard Lecture (Sec. 10 — N = 50)</b>	63.0	62.4	55.0
<b>Bio-focused SCALE-UP (Sec. 11 — N = 14)</b>	81.0	70.5	60.3
<b>SCALE-UP (Sec. 12 — N = 23)</b>	70.0	72.9	64.0

Both of the SCALE-UP classes (Secs. 11 and 12) exceeded the exam performance of the conventional lecture section (Sec. 10). While the bio-focused class (aimed primarily at biomedical engineers and biophysics majors) had additional biological content in the course and in their exams, a more direct comparison can be made between Secs. 10 and 12. It can be seen that the SCALE-UP section had an exam average about 9 points higher than the corresponding lecture section.

The Force Concept Inventory (FCI) [9] has been given to the Phys 21 classes in each semester. The composite FCI results over all five semesters are shown in Fig. 4 below.

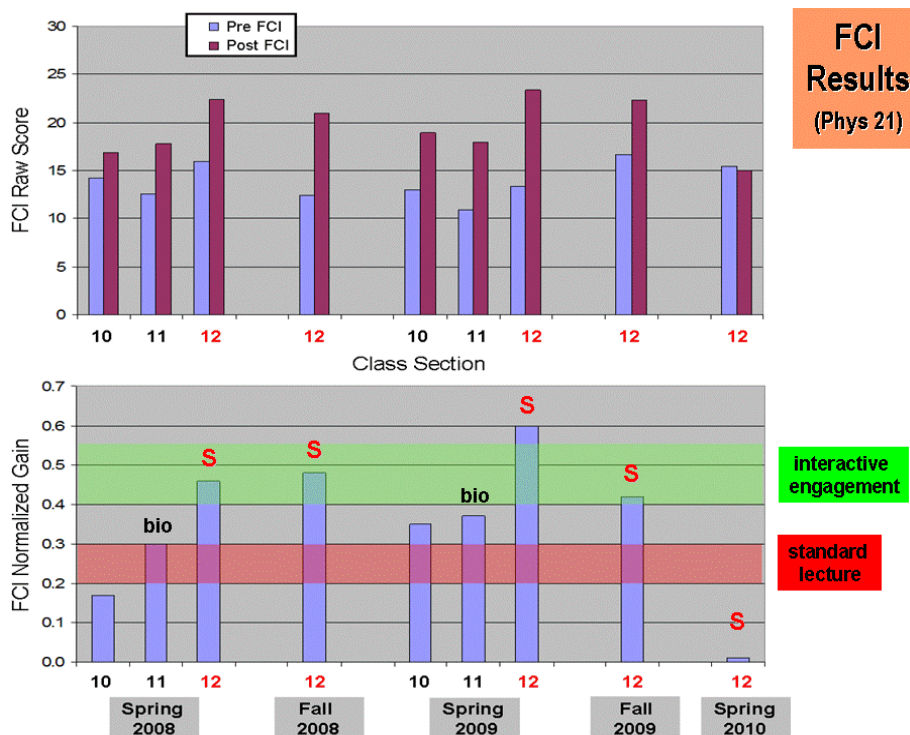


Fig. 4: Results from the FCI for the five semesters of Phys 21. The top panel shows the pre/post test scores; in the bottom panel, the normalized gain is displayed. SCALE-UP sections are indicated by a red “S”; bio-focused sections are indicated by “bio”.

The top panel shows the pre- and post-test scores, where the maximum score is 30. The bottom panel shows the normalized gain  $\langle g \rangle$  defined by Hake [11], such that  $\langle g \rangle = \frac{post - pre}{30 - pre}$ . Also shown is Hake's estimate of a range indicative of interactive engagement classes (the green band, for  $\langle g \rangle = 0.40-0.55$ ) as compared to conventional lecture classes (the red band, for  $\langle g \rangle = 0.20-0.30$ ). It is evident that the SCALE-UP classes (marked with a red "S") are performing very well, although the bio-focused SCALE-UP classes (marked by "bio") are only marginally outperforming the regular lecture classes (Sec. 10). All of the SCALE-UP classes are showing gains well into the interactive engagement domain (green band), with the exception of Spring 2010 when the delivery of the FCI post-test was somehow compromised by time constraints.

In the Spring 2008 semester, the Colorado Learning Attitudes about Science Survey (CLASS) [10] was given to all three sections of Phys 21. The results for the overall CLASS score are shown below in Fig. 5, where higher scores indicate more expert-like attitudes towards science.

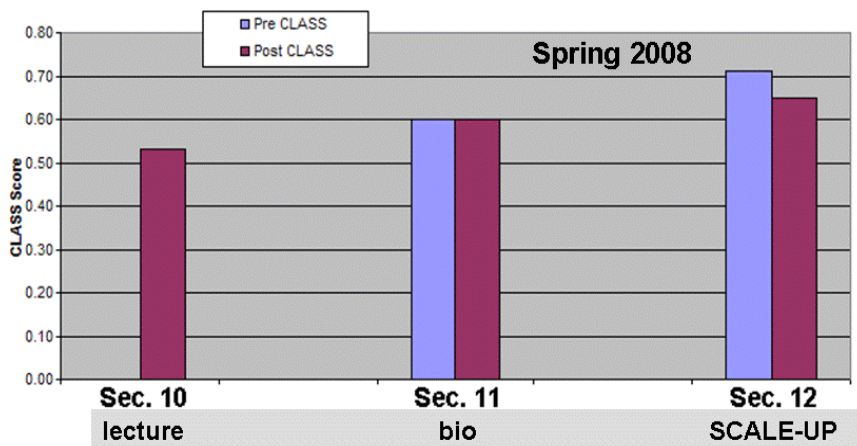


Fig. 5: Results for the pre- and post-tests from the CLASS survey for the Spring 2008 semester of Phys 21. There was no pre-test given at the start of the semester in the regular lecture class.

The main point of the CLASS survey is to observe the change in the students' attitudes from the beginning to the end of the semester. In this regard, the results do not look very impressive — none of the sections showed a gain (and in fact, Sec. 10 had not administered the pre-survey). This result is typical of calculus-based classes that have been surveyed, that is, the students actually show a deterioration of their attitudes after the semester.

Since there was no pre-survey for Sec. 10, it is interesting to look in more detail at the post-only results for all three sections. These results are shown below in Fig. 6, broken down into the 8 categories that are identified for the CLASS questions. The red arrows highlight specific categories in which the SCALE-UP section (Sec. 12) showed a significantly higher score in the post-survey. Note that these categories relate to problem solving and conceptual understanding. It is noteworthy, however, that the bio-focused section (Sec. 11) came out slightly ahead in the "Real World Connection" category (indicated by the blue arrow), possibly due to the emphasis on biological applications of physics principles.



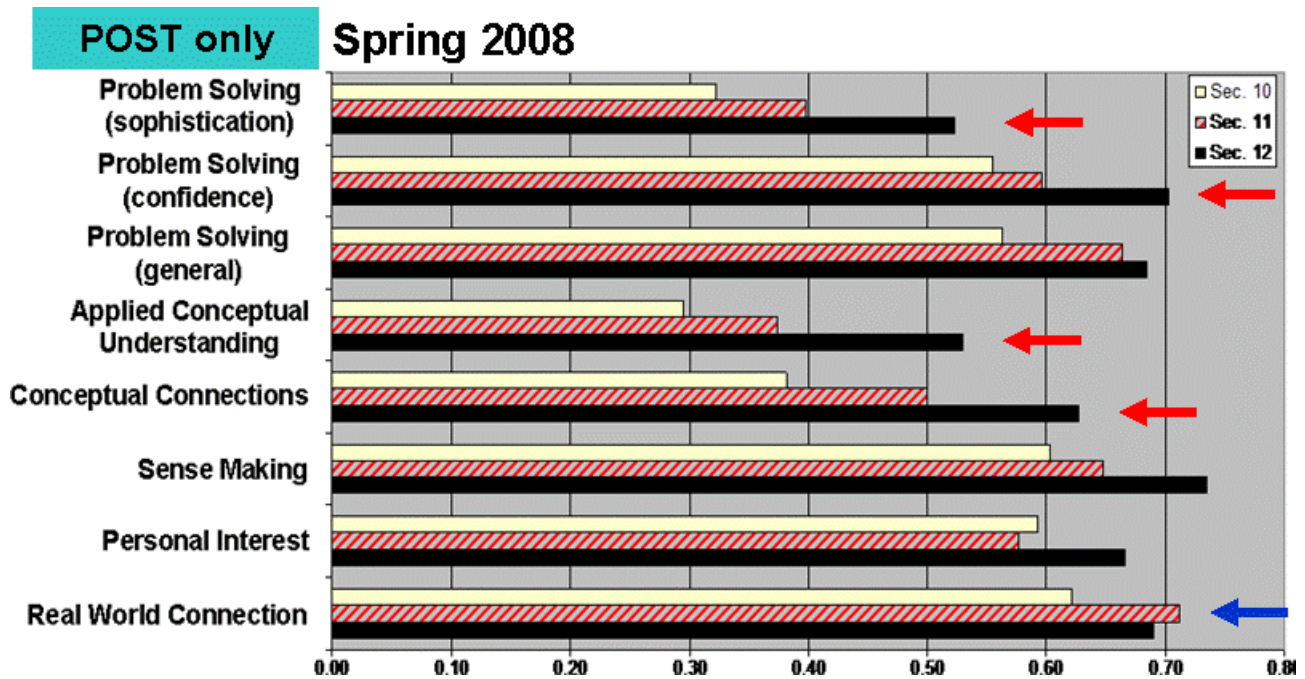


Fig. 6: Post-survey results only for the CLASS survey in the Spring 2008 semester of Phys 21, broken down into the individual component categories for science and attitudinal characteristics.

While most of the data that we have obtained thus far (as reported above) pertains to the Phys 21 class, we also have two semesters of experience with the second semester course, Phys 22. In this case, the standardized assessment that we used is the Conceptual Survey of Electricity and Magnetism (CSEM) developed by Maloney *et al.* [12]. Our results are compared to those of other institutions in Fig. 7 below — our data have been added to the plot from Ref. [12] as the filled green circles. The pre-test and post-test scores are plotted on the x and y axes, and lines corresponding to various values of the normalized gain  $\langle g \rangle$  are shown. Note that the two GWU semesters are fairly consistent with each other (two different years and two different instructors) and that the gain values of 41% and 44% are among the highest values compared to other institutions.

## CSEM Results (Phys 22)

pre = 33.3%  
post = 60.7%  
gain = 41.1%  
Spring 2009

pre = 27.2%  
post = 59.4%  
gain = 44.2%  
Spring 2010

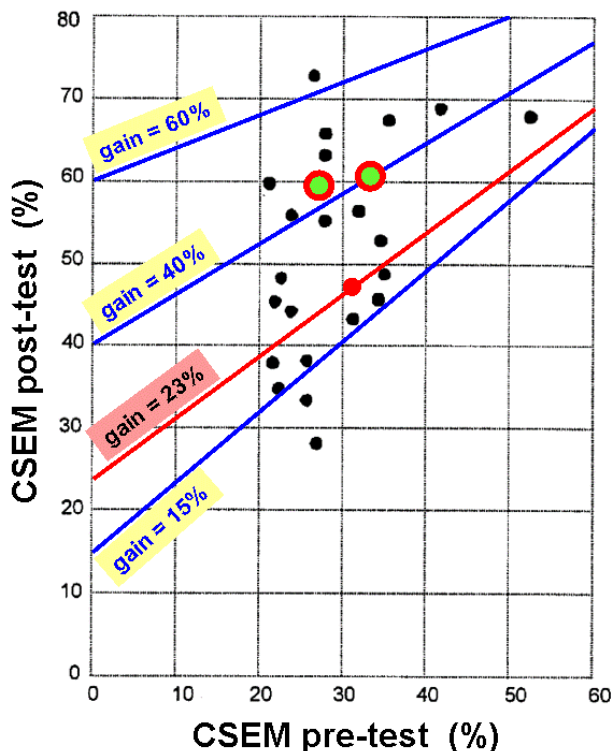


Fig. 7: Results from the CSEM for the two semesters of Phys 22, compared to the results from other institutions [12]. The specific pre- and post-test scores (with the corresponding normalized gains) are shown on the left, and these results are plotted as the two green data points. Different gain values are shown as lines of constant slope.

## IV. Extensions

At GWU, we are working to extend the SCALE-UP environment by modifying one of our introductory laboratory rooms (smaller than our existing SCALE-UP room). The modular trapezoidal tables shown in Fig. 8 below can be formed into hexagons, allowing us to arrange 24 students into 4 tables of six students each. This is shown in the left-hand panel of the figure. While this lab room is not used for the full deployment of SCALE-UP, the configuration of the room does at least enhance the collaborative nature of the introductory lab sessions which are associated with the conventional lecture courses. In this manner, we are able to offer labs in a “mini SCALE-UP” format that is more conducive to group learning.

The modularity of the trapezoidal tables permits easy rearrangement into other configurations. One alternate example, a standard classroom with parallel rows of desks, is shown in the right-hand panel of the figure. Other configurations are also possible, such as a single large circular conference table for meetings. Thus, this smaller SCALE-UP room has a built-in flexibility which makes it extremely versatile for a variety of academic or administrative functions.

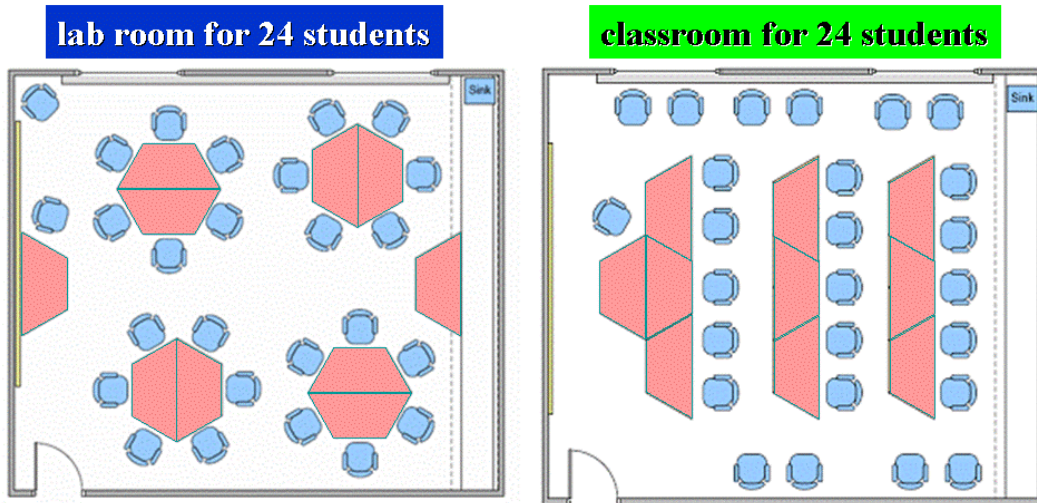


Fig. 8: Schematic view of a remodeled laboratory room using modular trapezoidal tables. The primary intention was to provide a “mini SCALE-UP” environment for lab sessions (left panel). The room can be reconfigured into a standard classroom arrangement, if needed (right panel).

Finally, we have the intention of expanding our current SCALE-UP room (the one shown in Fig. 1) by knocking down the wall into an adjacent classroom, effectively doubling the size of the classroom space. The schematic of this proposed classroom is shown in Fig. 9 below. This would enable us to offer SCALE-UP classes to 108 or 72 students, depending upon whether we place 9 or 6 students at each table. For a room of this size, one instructor would have to be assisted by two Teaching Assistants in order to provide sufficient coverage for the 12 tables in the room. We hope that this expansion will take place in the Spring 2011 semester, or at the latest, in Fall 2011.

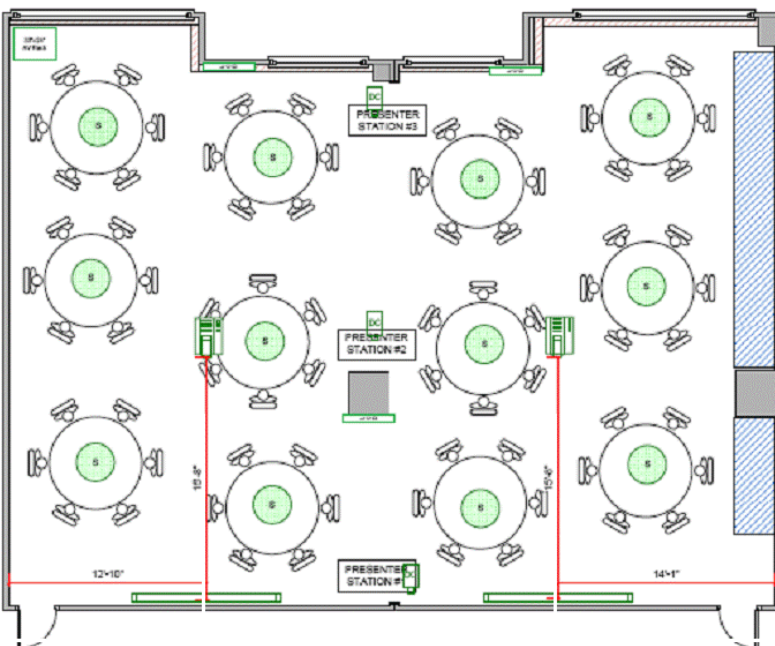


Fig. 9: Schematic view of a proposed plan for expansion of our SCALE-UP room to double its size (compare to Fig. 1 for current size). The expanded room will have 12 round tables, each holding either 6 students (as shown) or 9 students, giving a total of 72-108 students.

## V. Summary

We have been using the SCALE-UP collaborative group-learning pedagogy for five full semesters at GWU, which includes five semesters of Phys 21 and two semesters of Phys 22. Both of these classes are continuing in the current Fall 2010 semester. While our data are not exhaustive, we have evidence that students are performing better in the SCALE-UP class than in a conventional lecture class. Student engagement is high in the SCALE-UP environment, and it seems that students gain a greater facility with the physics material in this collaborative mode compared to less interactive approaches.

Educational trends favoring more interactive engagement techniques have been gaining momentum in colleges and universities in the United States over the past decade. This sentiment concerning the shortcomings of the conventional lecture style of science education has recently been echoed by Eric Mazur in a short and incisive article appearing in a more mainstream forum, namely *Science* magazine [13].

In closing, it is worthwhile to share some “impressions” from our direct experience in teaching the introductory physics classes utilizing the SCALE-UP pedagogy. Admittedly, the following comments are purely anecdotal, but at some level, the observations and intuition of the instructor have some validity in judging the effectiveness of an educational experience.

- SCALE-UP really squeezes the best out of students
- students work harder, but for greater rewards
- the student working groups actually gel into cohesive units
- the classroom atmosphere is much more dynamic
- the instructor gets to know the students better  
(and the students get to know each other better)

In the end, there is one final comment — it is considerably more satisfying to be a “coach” rather than a lecturer, and the SCALE-UP pedagogy definitely affords that opportunity. Ultimately, this is much better for the instructor and certainly it is more beneficial for the students.



## References

- [1] L.C. McDermott, *American Journal of Physics* **69**, 1127 (2001).
- [2] J. Wilson, *The Physics Teacher* **32**, 518 (1994).
- [3] R. Beichner *et al.*, “The Student-Centered Activities for Large Enrollment Undergraduate Programs (SCALE-UP) Project,” in *Research-Based Reform of University Physics*, edited by E.F. Redish and P.J. Cooney (American Association of Physics Teachers, College Park, 2007), Reviews in PER Vol. 1, <<http://www.per-central.org/document/ServeFile.cfm?ID=4990>>.
- [4] The VPython web site is located at: <http://vpython.org>
- [5] The SCALE-UP web site is located at: <http://www.ncsu.edu/PER/scaleup.html>
- [6] The *MasteringPhysics* web site is located at: <http://www.masteringphysics.com>
- [7] Randall D. Knight, *Physics for Scientists and Engineers: A Strategic Approach* (2<sup>nd</sup> edition), (Pearson Education, Inc., San Francisco, CA, 2008).
- [8] The Vernier Software and Technology web site is located at: <http://www.vernier.com>
- [9] D. Hestenes, M. Wells and G. Swackhamer, *The Physics Teacher* **30**, 141 (1992) and D. Hestenes and I. Halloun, *The Physics Teacher* **33**, 502 (1994).
- [10] W.K. Adams *et al.*, *Physical Review Special Topics in Physics Education Research* **2**, 010101 (2006).
- [11] R.R. Hake, *American Journal of Physics* **66**, 64 (1998).
- [12] D.P. Maloney, T.L. O’Kuma, C.J. Hieggelke and A. Van Heuvelen, *American Journal of Physics Supplement* **69** (Phys. Educ. Res.), S12 (2001).
- [13] E. Mazur, “Farewell, Lecture?”, *Science*, Vol. 323, p. 50 (2009) and references therein.

# Four Developmental Stages for Cultivation of Interdisciplinary Scientists and Engineers I

## — Concept and Course Design —

Kazuhiko Misawa<sup>1,2</sup>, Hiroyuki Shimada<sup>1</sup>, Masahiko Shoji<sup>1</sup>, Hiroki Minoda<sup>1</sup>,  
Kazuyuki Muroo<sup>1</sup>, Osamu Nitoh<sup>1</sup>, and Osamu Sano<sup>1</sup>

<sup>1</sup>*Department of Applied Physics*

<sup>2</sup>*Center for Higher Educational Development, Tokyo University of Agriculture and Technology  
2-24-16 Naka-cho, Koganei 184-8588, Japan  
[kmisawa@cc.tuat.ac.jp](mailto:kmisawa@cc.tuat.ac.jp)*

**Abstract:** We describe four developmental stages for sending quality graduates into society from our physics course. We established the SAIL program to develop student capabilities by progressing through four steps: study, analysis, innovative design and logical presentation. The SAIL program includes a project-based learning course to teach how to devise a solution to a problem and introductory courses to focus students' attention on the process of logical analysis based on objective data. We determined assessment checkpoints to evaluate whether students learn a systematic procedure of problem solving. The key to cultivating students who can integrate multidisciplinary fields and explore new interdisciplinary fields is demonstrated to be the development of their analytical abilities with quantitative reasoning.

### 1. Introduction

After leaving academia, most of our students' technical skills are not sufficient for their workplace because they are limited to the students' own major [1]. The more significant aspect for their future work should be the ability to simplify complex problems, design and improve experiments and find suitable solutions. A previous study using a questionnaire survey of physics graduates suggested that the most important abilities acquired from physics courses are extracting an essential issue and building a model, presenting one's ideas logically and understanding the principles of new technology [2]. Most teachers involved in physics education may agree with the survey findings that modeling, logical thinking and being insightful are important in the practical fields of science and engineering. Physics enables the deduction of a conclusion based on a limited number of fundamental principles and provides experimental predictions for unknown situations. Our objective is to cultivate quality graduates who can evolve into interdisciplinary scientists and engineers. For this purpose, we have to prepare consistent four-year undergraduate curriculum.

Japanese students have been better trained in preparing for entrance examinations by rote learning than by applying their knowledge for problem solving. Hence, they believe that rote learning is the most effective technique for knowledge development. Many students memorize the formulae of physics laws without even understanding the natural phenomena themselves. As a result of training in merely pattern recognition with no room for creativity and intellectual development, young students develop scant capabilities in analysis based on objective data. They can neither distinguish between a fact and an opinion nor deduce a conclusion from experimental results. Thus, there is a severe insufficiency in their power of logical thinking and expression, which is far from our desired outcome.

To address this alarming situation, the most effective intervention is to trigger students' intellectual interest immediately after they enter university. To optimize the malleability of university freshmen, we must define, at the outset of their undergraduate course, the scientific abilities

which these students have to acquire [3]. Our physics department set the goal of our consistent four-year curriculum as 'development of student abilities to integrate multidisciplinary fields of science and technology in order to explore new interdisciplinary fields beyond the existing framework'. We defined four developmental stages, study, analysis, innovative design and logical presentation (SAIL), throughout this curriculum [4].

In the present study, we describe the concept and the design principle of the SAIL program. We also present a detailed explanation of the purpose and methods of the Innovative design course in the next section. In particular, we investigate the checkpoints for assessment of the Innovative design course. Next, we describe the introductory courses for effective fulfilment of the Innovative design course. Finally, the assessment viewpoints are discussed in terms of students' logical and quantitative abilities.

## 2. Concept of SAIL

Figure 1 shows the conceptual diagram of the SAIL program. We devised the following four developmental stages for cultivation of quality graduates capable of evolving into interdisciplinary scientists and engineers. We named these developmental stages as "SAIL", which is an acronym consisting of the initial letters of the four stages.

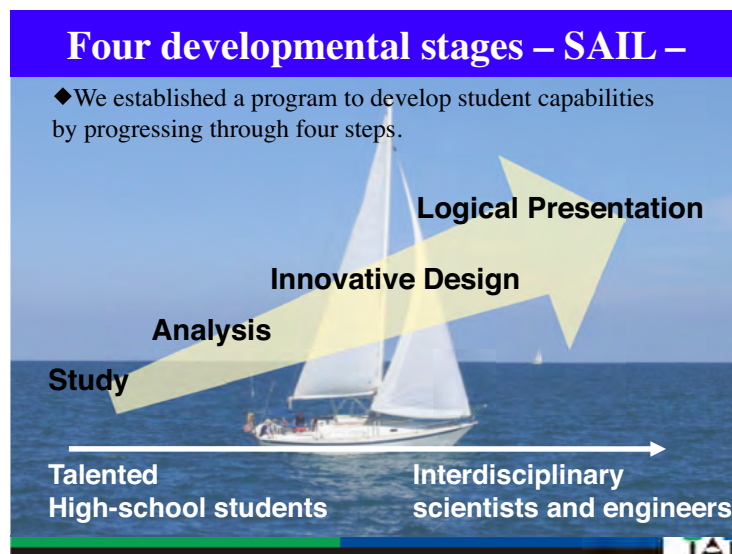


Fig. 1: Conceptual diagram of SAIL program

We present the stages in reverse chronological order to focus upon the desired outcome for students' professional capabilities:

**Stage 4: Logical Presentation** For interdisciplinary scientists and engineers, discussion with co-workers, especially in different fields, is very important. The skills such as those needed for quickly responding to others and being concise are significant. Hence, we set such logical presentation skills as the final stage, sometimes called the 'capstone' in hierarchical skill development curricula.

**Stage 3: Innovative Design** The most important abilities in the real world relate to identifying a problem and finding the solution independently. A systematic procedure for problem solving, such as a series of activities like the design of instrumentation, assembly, measurement and data

analysis, should be mastered. Therefore, we define this important stage as the Innovative design stage.

**Stage 2: Analysis** To discover the solutions of new problems, the process of analysis and deduction is fundamental. The analysis of a situation based on objective data and reasoning from cause to effect are required for the cultivation of innovative design abilities. This stage prepares students for the challenge of innovative design.

**Stage 1: Study** The pursuit of scientific and logical analysis requires strong motivation, inspired from one’s interest in nature itself. This interest in nature drives the students towards autonomous studying. This stage marks the beginning of the undergraduate course.

We established the SAIL program to develop student capabilities by progressing through four steps. Our physics course students take normal undergraduate courses, but motivated students also take these SAIL courses. The entire SAIL program is summarized in Table 1. Note that the introductory courses are compulsory subjects for all the physics course students.

Table 1: List of SAIL program

	Grade	Semester	Students in FY2009	
Introductory courses (three courses)	1	summer	65	compulsory
Modern Physics seminar	1	winter	22	optional
Elementary experiments	1	winter	65	
Innovative Design course I	2	summer	16	
Innovative Design course II	2	winter		
Sensors & Instrumentation	3	summer	24	
Advanced Innovative Design course I	3	summer	8	
Advanced Innovative Design course II	3	winter		

### 3. Innovative Design Course

#### 3.1 Purpose and Methods of Design Course

We created a project-based learning course that illustrates devising a solution to a problem through a systematic problem-solving procedure. The goal of the entire course is to complete the project design form shown in Fig. 2, demonstrating their use of the procedure. The students are guided through a research project by completing this project design form. At the beginning of the course, only the keywords are presented to the students. Typical keywords are listed in Table 2. Four categories –laser measurement, thermal convection, sensor and radiation measurement– are shown in the list. Four more categories have been recently added: microscopy, waves, energy conversion and vacuum. The categories are either phenomena or methods.

Students are required to fill out a project design form. The 'Target' and 'Motivation' sections are divided into two, and they start by filling out the 'Before' column. This indicates the students' original, intuitive and imaginative motivation for the unknown research project. Figures 3-5 show the entire procedure of the course. Several teachers give guidance about each of the keywords as shown in Fig. 3(left), in order to evoke student interest. Each student selects a subject on the basis of his interest.

			Date:
<b>Project Design Form</b>			
Laser measurement / Thermal convection / Sensors / Radiation measurement Microscopy / Waves/ Energy conversion / Vacuum			
Project Title			
Grade	ID#	Name	e-mail
	Before		After
Target			
Motivation			
Methods			
Apparatus			
Appendix			

Fig. 2: Project Design Form



Fig. 3: **(Left)**Giving guidance for keywords, **(Right)**Filling out project design form



Fig. 4: **(Left)**Presenting one's idea, **(Right)**Surveying background knowledge



Fig. 5: **(Left)**Preparing experimental apparatus, **(Right)**Performing experiments

In the next class, the students present their idea to their classmates and teachers and initiate discussion for the development of their projects. They try to check the consistency of their research strategy and choose suitable methods for the study.

They learn how to survey literature to acquire background knowledge. After designing the experiment, they start preparing experimental apparatus and perform experiments. During the course, they update their original (Before) idea as they repeatedly use their imagination. The most important element of this stage is the students' modifications of their experiment design through their own trial and error process.

The list in Table 3 shows some examples of students' subjects.

Table 2: List of keywords

Category	Keywords
Laser measurement	Displacement, Densimetry, Surface vibration Optical device, Refractometry, Distance measurement
Thermal convection	Simulation, Chaos, Climate Light scattering, Temperature, Flow
Sensors	Color, Electromagnetic field, Pressure Supersonic wave, Smell, Humidity
Radiation measurement	Health, Monitoring, Geiger counter Cosmic ray, Spectrometry, $\alpha$ - $\beta$ - $\gamma$ -rays

Table 3: List of subjects

Category	Subject Titles
Laser measurement	Refractive index of air
Thermal convection	Thermal characteristic of global warming gases
Sensors	RGB sensor using a prism
Radiation measurement	Measurement of the background radiation at TUAT Construction of a Geiger counter
Energy conversion	Construction of a sun-chasing solar panel Electric power generation from voice
Waves	Distance measurement using supersonic wave

### 3.2 Assessment by Poster Sessions

We created a course for poster sessions to experience intensive discussion with teachers and classmates. The purpose of poster sessions was to have repeated intensive discussions and to develop communication and collaboration skills, avoiding one-way arguments.

We devised assessment checkpoints, as shown in Table 4. The objective of the assessment is to determine whether the students learnt a systematic procedure for problem solving. The three checkpoint classifications were (I) Research activities, (II) Oral presentation and (III) Poster presentation.

The checkpoints for (I) Research activities trace the procedure, i.e. purpose / target / strategy / methods / background / parameters / results / discussion / principle. The checkpoints are used



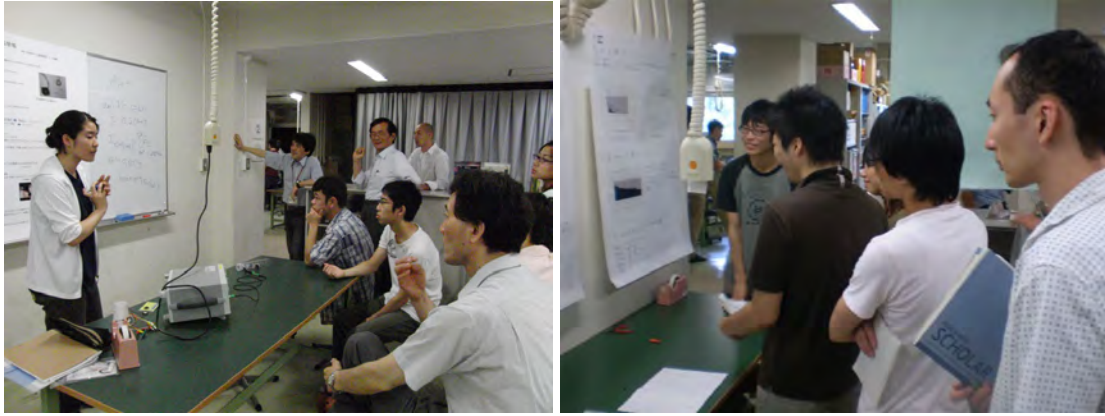


Fig. 6: Poster session

to verify innovative design abilities in our SAIL concept. One should clarify the problems and the purpose of the solution. For an effective solution, the target should be focused upon and the strategy should be consistent. One has to choose suitable methods and set appropriate experimental parameters and collect reliable results in order to analyze the problematic situation and find the solution. The analysis has to be logical and quantitative for better reasoning. The key to problem solving is well-organized knowledge and understanding of the underlying principles. It is important to assess these achievements in research activities not only during the classes but also at the poster sessions, where peer review comes into play. The final SAIL stage, i.e. logical presentation, can be logically organized only when the research procedure has been properly followed.

The checkpoints for (II) Oral presentation and (III) Poster presentation are measurements necessary for logical presentation skills. We checked students' skills in verbal description, in particular, because they used the figures and tables in the posters as supporting materials for the discussion.

Table 4: Checkpoints for assessment

(I) Research activities	
Purpose	Did s/he clarify the purpose and problems?
Target	Did s/he focus on her/his target?
Strategy	Did s/he check consistency in research strategy?
Methods	Did s/he choose suitable methods for the study?
Background	Did s/he survey the background knowledge of the study?
Parameters	Did s/he set appropriate experimental parameters?
Results	Did s/he collect reliable experimental results for analysis?
Discussions	Did s/he deepen discussion logically and quantitatively?
Principle	Did s/he understand the underlying principle of the study?
(II) Oral presentation	
Verbal Description	Did s/he speak about the research logically and concisely?
Responsiveness	Did s/he answer questions by getting to the point of the problems?
(III) Poster presentation	
Figures/Tables	Did s/he prepare figures and tables persuasive enough as proofs?



## 4. Introductory courses in SAIL program

The Innovative design course mentioned in the previous section cannot provide effective educational benefits unless the students who take the course have already learnt the methods for evidence-based logical synthesis. This requirement increases the significance of the introductory courses and explains why we defined 'analytical abilities' as the precedent step to innovative design and logical presentation.

In the introductory courses, our focus should definitely be on 'the process of logical synthesis'. As mentioned above, the students who have just completed their entrance examinations tend to rely on rote learning, so first we must change students' sense of the value of rote learning versus creative application of that learning. Our introductory courses are not for supplemental study, which, we believe, makes no sense when students are still in the rote learning mode, where they will just memorize the information and solution results. Instead, the courses were designed to teach students about how physics should be studied questioningly and purposefully and how to deduce basic laws. We evoke their intellectual curiosity and deepen that interest through experience and observation. Such experiential learning is a basic principle of adult learning theory.

We began our introductory courses in classical mechanics, electrodynamics and thermodynamics by linking them to the students' experiment course. In these courses, we limit the content to high-school curriculum topics, limited to essential issues in order to avoid piling up knowledge, but rather to stimulate students' interest through experimental demonstrations. An even more important purpose is to perform the supporting experiments in a manner that demonstrates how to quantify the physical principles and to deduce basic laws. We emphasize that the combination of engaging demonstrations and fundamental experiments is indispensable. Through the reasoning process from cause to effect, we are able to develop the students' independent thinking capability.

Moreover, the students were often required to give a verbal description of a physical process they had observed in the class. The assessment is not based on their (rote) knowledge, but their understanding as they expressed it in written text. The final examinations for the qualification also focused on verbal explanation of the physics principles and reasoning process based on their observations.

### 4.1 Example: Ampere's force law

At the beginning of this demonstration, we showed a so-called line-tracing car, which automatically traces a black line on white paper. We asked students to explain the components and mechanism of the car. The car comprises photosensors and electric motors, and we focused the students' attention on the driving component. The driving component is an electric motor. Figure 8(left) shows a demonstration of the line-tracking car running along the black line. Next, we showed a model of an electric motor. The students could look into the structure of the motor, and we asked them to explain the operating principle of the electric motor as shown in Fig. 8(right).

These demonstrations are meant to evoke interest and concern. Even if they succeed in that, stopping at that point does not develop the students' skills in logical thinking in physics. The important element for the students is to experience fundamental experiments that enable them to quantify the physical principles associated with basic laws. We conducted an experiment using the force exerted on an electric current by a permanent magnet, as shown in Fig. 9(left). The students learnt how to analyze the data quantitatively and discover the basic law. Finally, we asked the students to explain the principle of an electric generator. Figure 9(right) shows the lecture demonstration, which teaches that the electric motor can also be used as an electric generator. Some students were surprised to find that the exact same components are used for both electric motors and generators.



Fig. 7: Classroom for introductory courses

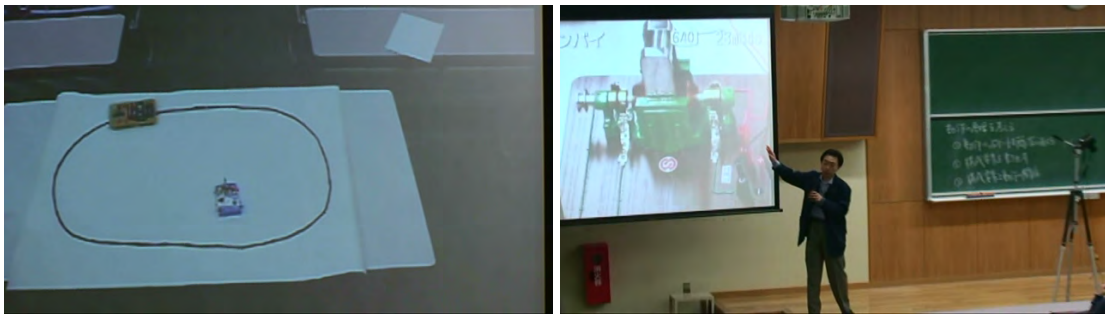


Fig. 8: **(Left)**Demonstrating a line-tracing car, **(Right)**Explaining the structure of an electric motor

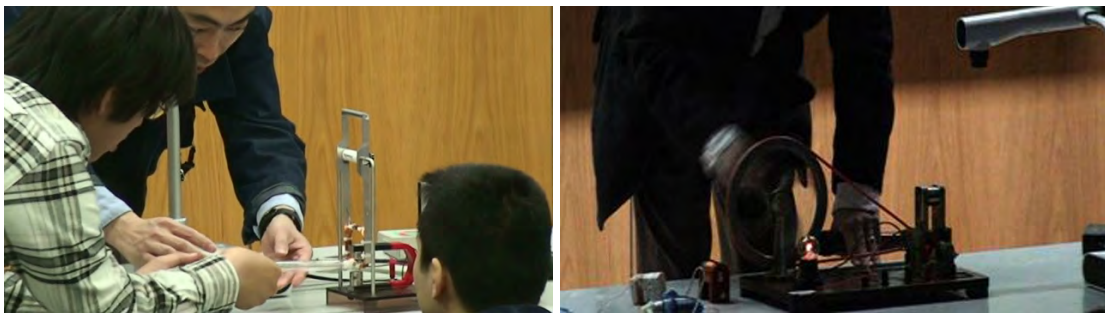


Fig. 9: **(Left)**Performing basic experiment on Ampere's force as a lecture demonstration, **(Right)**Showing an electric generator



Fig. 10: Repetition of the lecture demonstrations by each student

The students repeated the lecture demonstrations in their lab class, as shown in Fig. 10. The lab class comprises testing experiments of which the students design some part, whereas the lecture demonstrations allow them to only observe experiments.

## 5. Discussion and Conclusion

Each student has four opportunities to take the Innovative design courses at the summer and winter semesters in the second and third years during their undergraduate course. Only the students who passed either of the Innovative design course I or II in the second year are permitted to take the Advanced Innovative design course I or II in the third year. Here, we define an experience score as the number of times they took an Innovative design course. For example, when one student took the Innovative design courses I, II and the Advanced Innovative design course I, the experience score is counted as 3.

We also evaluated the achievement of each student according to the checkpoints shown in Table 4. We scored all the checkpoint items on a scale of 1–4: Poor (1), Fair (2), Good (3) and Excellent (4). The scores of these checkpoints were found to correlate well with the students' experience scores.

One of the important results is that the items shown in Table 4 were classified into two categories. Group (A) includes Purpose, Target, Strategy, Background and Principle, whereas Group (B) contains Parameters, Results, Discussion, Verbal Description, Responsiveness and Figures/Tables. For Group (A), the average score almost exactly corresponds to the experience score, indicating that the students who participated in all four courses (Innovative design courses I, II and Advanced Innovative design courses I, II) achieved an Excellent (4) level score. On the contrary, the marks of Group (B) fell into Good (3) at best. The descriptions and responsiveness of the talented students in our class were logical, but their logical synthesis was still qualitative, and the items in Group (B) require a quantitative viewpoint. Hence, it seemed difficult for them to develop their analytical abilities for quantitative evidence unless special care was taken. We are going to improve our Innovative design course so that we can guide the students more effectively in quantitative reasoning. It is also important to focus on quantitative treatment in the 'analysis' stage of the SAIL curriculum. In a subsequent study, we shall discuss the correlation between the analytical abilities and logical presentation skills using statistical data. In this second study, the significance of the introductory courses will be emphasized [5].

- [1] A. Karelina and E. Etkina, "Acting like a physicist: Student approach study to experimental design", *Phys. Rev. ST Phys. Educ. Res.* 3, 020106 (2007).
- [2] M. Goda, R. Lang, T. Hyodo, Y. Watanabe, "Views on Undergraduate Education from Graduates of Physics and Applied Physics Departments", *Butsuri*, 61, 184-189 (2006).
- [3] E. Etkina, A. Van Heuvelen, S. White-Brahmia, D. Brookes, M. Gentile, S. Murthy, D. Rosengrant, and A. Warren, "Scientific abilities and their assessment", *Phys. Rev. ST Phys. Educ. Res.* 2, 020103 (2006).
- [4] K. Misawa, H. Shimada, K. Muroo, O. Nitoh, and O. Sano, "Four Developmental Stages for Cultivating Interdisciplinary Scientists and Engineers – SAIL program –", *Book of Abstracts, AO-10* (2009)
- [5] K. Misawa, H. Shimada, M. Shoji, H. Minoda, Y. Kato, K. Muroo, O. Nitoh, and O. Sano, "Four Developmental Stages for Cultivating Interdisciplinary Scientists and Engineers II– Correlation between the analytical abilities and logical presentation skills –", submitted.

# Four Developmental Stages for Cultivation of Interdisciplinary Scientists and Engineers II

## – Correlation between Analytical Abilities and Logical Presentation Skills –

Kazuhiko Misawa<sup>1,2</sup>, Hiroyuki Shimada<sup>1</sup>, Masahiko Shoji<sup>1</sup>, Hiroki Minoda<sup>1</sup>,  
Yukari Kato<sup>2</sup>, Kazuyuki Muroo<sup>1</sup>, Osamu Nitoh<sup>1</sup>, and Osamu Sano<sup>1</sup>

<sup>1</sup>*Department of Applied Physics*

<sup>2</sup>*Center for Higher Educational Development, Tokyo University of Agriculture and Technology  
2-24-16 Naka-cho, Koganei 184-8588, Japan  
[kmisawa@cc.tuat.ac.jp](mailto:kmisawa@cc.tuat.ac.jp)*

**Abstract:** We describe the correlation between analytical abilities and logical presentation skills in the SAIL program, which we developed for cultivating engineering and science students who can integrate multidisciplinary fields and explore new interdisciplinary fields. We opened innovative design courses to teach systematic procedures of problem-solving and introductory physics courses to teach the process of logical synthesis. Three evaluation indices are used to verify the consistency of the curriculum: the students' scores on the oral examination for graduate-school admission in the fourth year, their grade point averages (GPAs) in introductory physics courses and their GPAs in normal undergraduate courses. The correlation between the GPAs of the students in the introductory courses and their oral examination scores was found to be sufficient, with a correlation coefficient of 0.55 for the students who took the innovative design courses. This high correlation coefficient indicates that the GPAs in the introductory courses are a good index for the students' potential abilities in logical presentation. We confirm the validity of the consistency of the four developmental stages.

### 1. Introduction

The purpose of our project is to cultivate highly competent graduates who can integrate multidisciplinary fields of science and engineering. As described in the precedent paper, we established a consistent four-year curriculum based on the educational concept of SAIL (SAIL is an acronym made from the initial letters of the four developmental stages in this curriculum: Study, Analysis, Innovative Design and Logical Presentation.) [1]. The SAIL program is composed of project-based-learning courses and introductory courses.

The real world demands the capabilities to identify a problem and to find its solution [2]. To communicate with co-workers, skills in verbal description and responsiveness are also required. Here, responsiveness means the skill of responding quickly to others and getting to the point of the problem. We defined these essential steps in the development of interdisciplinary scientists and engineers as Innovative Design and Logical Presentation, respectively. Our project-based-learning courses, which are called Innovative Design courses (ID courses), teach systematic procedures of problem-solving. Students' achievement is evaluated at poster sessions in our SAIL program, where the students engage repeatedly in intensive discussion. We identified several checkpoints for measuring their innovative design and logical presentation abilities and rated them on a scale of 1–4.

From the assessment results of the presentation in the SAIL program, we found that most students find it difficult to develop analytical abilities based on quantitative evidence. Hence, before the students take the ID courses, they should attend a preparatory course in which they are able to learn a process of quantitative analysis and a method of logical deduction. For this

purpose, we created introductory physics courses to teach the process of logical synthesis. These introductory courses include classical mechanics, electrostatics and thermodynamics.

Our main interest is consistency of the curriculum's outcomes as a result of the adherence of the curriculum's contents and instructional methods with its objectives. We expect that students' excellent logical presentation skills should be supported by their analytical abilities learned in the introductory courses. In the present study, we measured the correlation between students' analytical and logical presentation abilities in the SAIL program. We plotted the score of their logical presentation skills as a function of the score of their analytical abilities, and obtained a correlation coefficient. In order to validate the effectiveness of the ID courses, we compared the score of the oral examination for graduate school admission between the students who took the ID courses and those who did not.

## 2. Questionnaire Survey

Most students tend to memorize mathematical formulae without reasoning through the principles of the laws of physics. The purpose of our introductory courses is to change students' sense of values so that they understand the importance of the process of reasoning through the principles. Hence, we asked the students to give a verbal description of physical processes in both the class and the examination.

In addition to the qualification examinations, we conducted a questionnaire survey to confirm the change in students' sense of values. The questionnaire contained the following questions.

- (1) Did you understand the objective(s) of this introductory course?
- (2) Did you learn something different in this course from the high-school class?
- (3) Do you think that your ability is improved after this course?

In the present analysis, we used text mining to identify interesting patterns from written text as open-ended answers to the questionnaire. By text mining, particular combinations of keywords were extracted from the answers' natural language text.

For the first question, 16% of the respondents used a combination of *formulae / understanding / physical / answer*. Typical answers written by the students are shown in Table 1. Just after admission to the university, many students seem to mistake understanding with giving the correct rote answer to a question. Consequently, they are likely to memorize the answers of foreseeable questions without genuine understanding of the principles underlying the answers. This 16% of the students changed their mind and came to think that understanding means conceptual comprehension.

Another 16% used a combination of *physics law / phenomena / real world / generalize*. At the beginning of the course, most of the students tend to focus on the final solution of the problem. They are likely to skip thinking through the process, because analyzing the process is time consuming. This 16% of the students changed their mind and came to think that generalization is the best consequence of process analysis.

The last question is very important, because it is directly connected to self-assessment. Self-assessment is reported to be more important than any feedback provided by teachers [3]. We should guide the students to modify their own learning in order to achieve their performance goals. For the last question, 23% of the respondents used a combination of *physical / ideas / better / thinking*. The students become increasingly aware of their own thinking power. Thinking is related to the ability to understand physical principles, which means that reasoning and deduction are important for physics.

Another 21% used a combination of *sentence/formulae/expression/concrete*. These students were markedly poor at logical thinking and expression. They could not distinguish a fact from an opinion. This 21% showed an improvement in verbal description skills and became able to

express what they truly understood in logically organized sentences.

Table 1: Particular combinations of keywords extracted by text mining and corresponding typical answers

(1) Did you realize the target(s) of this introductory course?	
16%	<i>formulae / understanding / physical / answer</i> <ul style="list-style-type: none"> <li>● <i>For better understanding of the underlying physics</i></li> <li>● <i>To understand the meaning of physics formulae by performing experiments</i></li> </ul>
16%	<i>physics law / phenomena / real world / generalize</i> <ul style="list-style-type: none"> <li>● <i>The process for deducing a general law from observation of familiar physical phenomena</i></li> <li>● <i>The procedure for generalizing a physics law from natural phenomena in the real world</i></li> </ul>
(3) Do you think that your ability is improved after this course?	
23%	<i>physical / ideas / better / thinking</i> <ul style="list-style-type: none"> <li>● <i>My thinking power seems to be enhanced because I learned that various natural phenomena can be understood by physical principle.</i></li> </ul>
21%	<i>sentence/formulae/expression/concrete</i> <ul style="list-style-type: none"> <li>● <i>The level of understanding can be judged by writing sentences. It is necessary to understand the meaning of physical laws and relevant formulae.</i></li> <li>● <i>Now I can imagine concrete phenomena, but have not gotten used to expressing them in written sentences.</i></li> </ul>

### 3. Evaluation Indices

In the present study, we used three evaluation indices: the score of the oral examination for graduate-school admission in the fourth year, the grade point averages (GPAs) score of three introductory physics courses and the GPAs of students in normal undergraduate courses. These evaluation indices are common among all the students irrespective of their experience of the SAIL program; hence, we can compare these scores between the students who took the ID courses and those who did not.

**Oral examination for Graduate School Admission** The score of the oral examination offers a direct measure of logical presentation skills at the final step of our developmental stages. As described in the precedent paper, our SAIL program considers verbal communication skill to be more important than arithmetic ability or the amount of knowledge. We identified scientific abilities that should be evaluated by oral examination. The admission criteria are the ability to give explanations for physical processes, apply logical judgement using evidence and responsiveness to the scientific discussion, as well as a conceptual understanding of physics. Each checkpoint is scored on a scale of 1–4 –Poor(1), Fair(2), Good(3) and Excellent(4)– which corresponds to the GPA. Since only the motivated students take the innovative courses, this score is expected to be enhanced after finishing the ID courses in the SAIL program.

**GPA of introductory courses** The average score of the introductory courses provides an indication of each student’s analytical abilities, which is at the second stage in our educational steps. The GPAs of these introductory course measure the students’ reasoning ability. Since the introductory courses are required for every student in our faculty, this performance measure is a basic evaluation of our entire curriculum.

**GPA of normal undergraduate courses** The average score of the normal undergraduate courses are usually used for assessment of the undergraduate students.

#### 4. Correlation

Figures 1(a) and (b) show the correlation between the students' scores on the oral examination and their GPAs in the introductory courses. Figure 1(a) represents the correlation for students who took ID course in our SAIL curriculum. Hereafter, this group will be called 'ID course students'. Figure 1(b) represents the correlation for students that did not take the ID course; this group will be called 'non-ID course students'. The correlation was found to be sufficient with a correlation coefficient of 0.55 for ID course students. However, the correlation coefficient was only 0.11 for non-ID course students. The difference between these correlation coefficients was unexpectedly large. The low correlation coefficient of 0.11 is mainly due to the students who scored above average in the introductory courses performing poorly in the oral examination.

The average and the standard deviation of the oral examination score were 2.90 and 0.46 for ID course students, and 2.53 and 0.38 for the non-ID course students. The highest score for the oral examination was 3.25 among non-ID course students, whereas nine ID course students scored higher than 3.25.

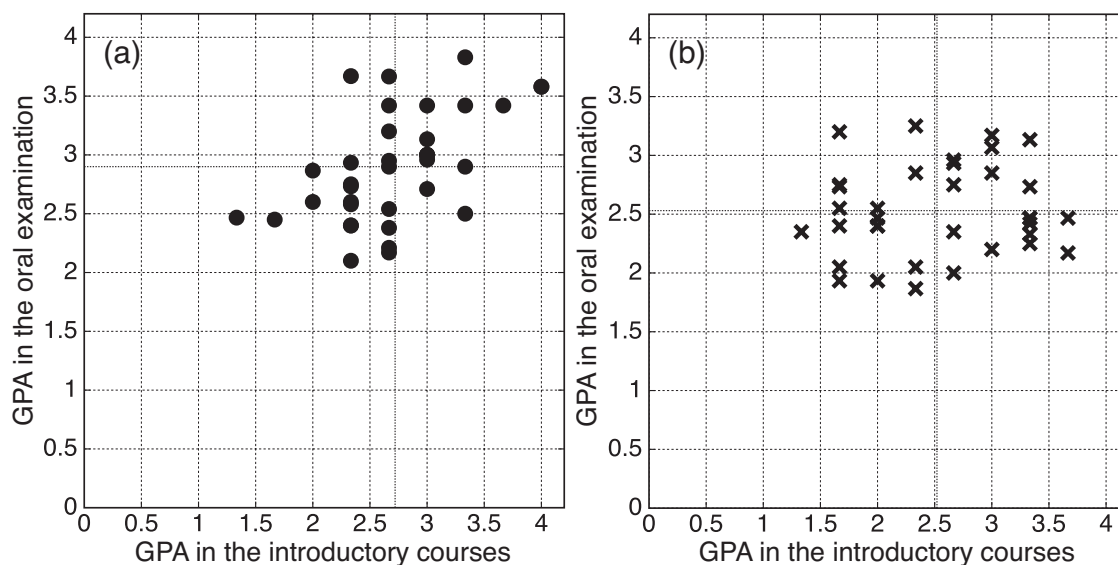


Fig. 1: Correlation between the students' score on the oral examination and their GPA in the introductory courses, (a) for ID course students and (b) for non-ID course students.

In comparison, the correlation between the students' GPAs in the introductory courses and in the normal undergraduate courses is depicted in Figs 2(a) and (b). The correlation coefficient was found to 0.51 for the ID course students and 0.69 for the non-ID course students.

#### 5. Discussion and Conclusion

The score of the oral examination was well correlated with the GPA in introductory courses for ID course students. This indicates that the GPA in the introductory courses is a good index for students' potential abilities in logical presentation. Students' logical presentation skills should be developed based upon their analytical abilities. In our introductory courses, we use lecture demonstrations to teach procedures for quantifying physical principles and deducing basic laws. The result of text mining of the questionnaire survey indicates that the objective of the introductory courses was achieved. The skills of analysis and deduction are fundamental



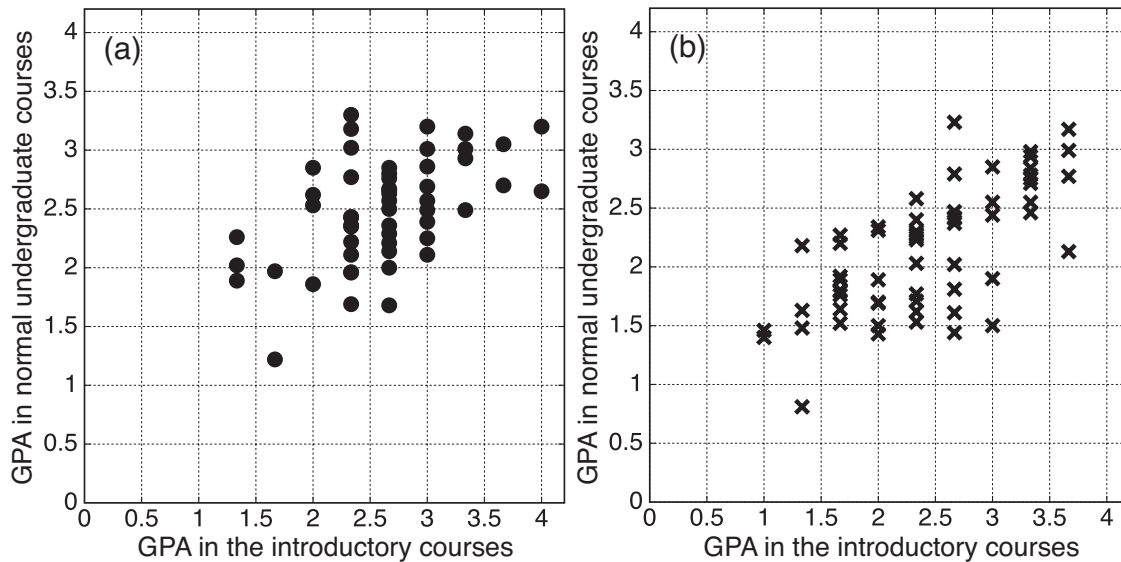


Fig. 2: Correlation between the students' GPAs in normal undergraduate courses and in the introductory courses, (a) for ID course students and (b) for non-ID course students.

for communication capabilities in responding quickly to others and getting to the point of the arguments. The effectiveness of our introductory courses is verified by the strong correlation between the ID course students' GPAs and their high scores on the graduate-school admission exam.

However, this is not the case for the non-ID course students. A key result to be considered here is the lower average score of the non-ID course students. In particular, some students with a high GPA score in the introductory courses performed poorly in the oral examination. These non-ID course students were not motivated by the SAIL program and may still prefer rote learning of questions and answers. Consequently, they performed poorly in verbal description and responsiveness at the examination.

Eight ID course students scored higher than the highest score among the non-ID course students. All these eight students scored above average in the introductory courses. This result also verifies that the introductory courses in the SAIL program help develop the students' potential. The ID courses, too, possibly maximize the students' potential.

On the other hand, the difference between the ID and non-ID course students is not remarkable in the correlation between their GPAs in the introductory courses and in the normal undergraduate courses. We often find that those students who are likely to memorize problem solutions without reasoning get a high average score in the normal courses. This results partially from the fact that our faculty's entire curriculum is not yet optimized with the SAIL program's instructional methods.

In conclusion, we validated the consistency of the four developmental stages established for an undergraduate curriculum in our faculty. Our proposed educational concept, SAIL, is expected to become a model system of physics education for the real world.

- [1] K. Misawa, H. Shimada, M. Shoji, H. Minoda, K. Muroo, O. Nitoh, and O. Sano, "Four Developmental Stages for Cultivation of Interdisciplinary Scientists and Engineers I— Concept and Course Design —", submitted.
- [2] A. Karelina and E. Etkina, "Acting like a physicist: Student approach study to experimental design", *Phys. Rev. ST Phys. Educ. Res.* 3, 020106 (2007).
- [3] P. Black and D. Wiliam, "Inside the Black Box: Raising Standards through Classroom Assessment", *Phi Delta Kappan*, 80 (2): 139-148 (1998). (Available online: <http://www.pdkintl.org/kappan/kbla9810.htm>).



## Mental representation in relative velocities

Bastién Montoya Gustavo. M\*., Rodríguez Soria Abelardo. L\*., Suárez Rodríguez C. Pilar. \*\*

\* Universidad Autónoma Metropolitana-Azcapotzalco, Av. San Pablo 180 México D.F. 02200.

[gmbm@correo.azc.uam.mx](mailto:gmbm@correo.azc.uam.mx)

\*\* UASLP and UVM San Luis Potosí, México.

Freshmen in the first physics courses have problems to describe relative motion (Saltiel & Malgrange, 1980). We intended to investigate that situation with freshmen in two Mexican universities; we chose students that were taking Elementary Physics, a course that includes the subject of relative velocity. Such students have already gone through the introductory part of two-dimensional vectors, and know the mechanism of vector addition and subtraction.

When a student solves a problem of relative velocities in two dimensions, he usually calculates a vector difference; what we want to know is if that vector solution of the situation implies an understanding of the relative movements involved, or whether there is a misconception or a cognitive obstacle in the mental representation of the students.

We have found that the graphical part of the solution is by far more complicated than the algebraic part, because the students have to activate their physical sense of velocities, and the contradictions in their analysis are related to their representation of the movement and the frame of reference on which the analysis is based. The teacher expects that the student uses a frame of reference clearly established, in which the transformations of velocities are specified. But what he finds is that the frame is not clearly established, because in the questions about everyday life situations, where the student can find fixed reference points and from there base his analysis, show that the student constantly goes back and forth from a fixed frame to one attached to a moving object

In previous work [Monaghan and Clement, 2000] some misconceptions of the students about the movement have been detected, for instance: it is evident that, in problems with two moving objects, when two objects are in the same position, they are assigned the same velocity, or the well known confusion existing between speed and acceleration.

### Objectives and Methodology

In our work we intend to investigate the use of frames of reference in relative velocity problems.

We initiated this work by designing a quiz containing qualitative and quantitative questions that we pose to our students in some moment, be it in class or during examinations. The analysis of the students' responses helped us to understand the origin of the difficulties concerning the interpretation of relative movements in two dimensions, and the solution of the problems associated with this type of movements.

The quiz shown at the end of this paper was posed to freshman students in two different universities, in different parts of Mexico. In both cases, the subject of velocity in two dimensions was not yet discussed. After instruction, a second quiz was given, that is still being processed.

The answers to several questions were analyzed. The first problem, very usual and simple, was related to movement in one dimension (See annex). It is the following:

A car is moving to the north at  $75 \frac{\text{Km}}{\text{h}}$ ; behind it is a bicycle moving at  $25 \frac{\text{Km}}{\text{h}}$ , in the same direction.

The first question was to show the direction the velocity of the car has with relation to the bicycle. The answers to this question, apparently not difficult at all, were as follows:

	<b>northward</b>	fixed	southward	others
Direction of the velocity of the car, relative to the bicycle.	36 84 %	4 9 %	3 7%	None

The second question, symmetrical to the first, asking for the direction of the velocity of the bicycle, **relative to the car**, was answered as follows:

	northward	Fixed	<b>southward</b>	others
Direction of the velocity of the bicycle, relative to the car.	18 42 %	1 2 %	23 54 %	1 2 %

We observe that, whereas the two questions are symmetrical, the percentages of correct answers are not. The one with most correct answers (84%) is the first question that asks to observe the movement from the student's own reference system.

In the second question, the students are asked to change to a system fixed in the car, and describe the movement as seen from there, and some of them are unable to do so. They remain on their own system of reference, and about half of them (54 %) realize that from the car, the bicycle is seen to move backwards, *i.e.*, to the south. This difficulty has to do with the context of the statement of the problem, in which the student is part of the configuration. In spite of representing an additional difficulty, we observe that 42 % of the students did not use an external frame of reference, free from the bicycle and the car, and thus they answer that the bicycle goes to the north.

The problem, made evident in the interviews we have with the students, is that the student is analyzing the question from his own frame of reference, and not of the car moving forward, because, when we face the student and ask him to think that he is riding inside the car, and try to imagine how he would see the movement of a bicycle moving more slowly, he has no trouble in giving the correct answer.

The analysis of this question allowed us to discover that the students have not a misconception in this case, but rather have trouble to establish a fixed reference system that can be used in different situations. In the interview a question was introduced, about the collision of two cars moving towards each other, and we realized that the student does not use the same system of reference for both cars, but attaches a system to each car. This happens in movement in one dimension; let us see now what the situation in two-dimensional movement is.

### Question3. Object falling from a moving vehicle

	parabola or straight line backwards	<b>parabola forward</b>	rotation	horizontal
Path of the falling brick.	23 54%	18 42 %	2 5 %	None

These answers show that there is confusion about the relative movement during a free fall. However, instead of labeling our student's thinking as "pre-Galilean", we can conclude that this is again a frame of reference problem, and that hypothesis is verified in the interviews. The difficulty consists in the students using a frame of reference fixed in the brick, from which they "see" the truck as moving away. This is by no means the right system, but it is the one the student tends to use. The

way to solve this difficulty, both in students and teachers, is to perform a mathematical analysis, which does not involve many physical explanations, but gives the desired answer.

Let us look at the answers to other questions on two-dimensional relative motion, that can be explained with the hypothesis that they are given from the wrong frame of reference, *i. e.* the student is reluctant to leave behind the frame of reference attached to the moving body, and besides, mixes that system with the inertial system of an external observer.

The next questions are about two moving ships, and the students are asked to give the relative direction of motion. Here the student does have to consider the frame of reference of each ship to give his answer.

#### Question4

	first quadrant	<b>second quadrant</b>	third quadrant	fourth quadrant	Not answered
Direction of the velocity of ship A as seen from B.	16 37 %	15 35 %	7 16%	3 7 %	2 5%

#### Question 5 (symmetrical to the former)

	first quadrant	second quadrant	third quadrant	<b>fourth quadrant</b>	Others
Direction of the velocity of ship B as seen from A.”	11 26 %	5 11 %	2 5%	19 44 %	6 14%

In the first of these two questions, the majority of answers is that the relative direction of motion of A with respect to B is approximately the same of ship A, *i.e.*, the student is not fixed on the frame of reference of ship B, because he is interested in the movement of ship A; this may be a problem of reading, even a problem of comprehension of the language of the statement, but in individual interviews we verify that the question was understood correctly.

The answers to the question on the relative direction of A with respect to ship B, show that a majority of students do not give the correct answer, but in this symmetrical case there are also comprehension problems, and a 26% place the movement in the first quadrant, which is understandable, because again, that is the direction of ship B in its own reference system

Answers to these two problems show again the resistance of students to abandon the frame of reference of the moving body.

It is worth mentioning here that in a first, qualitative approximation, it is not possible to deduce the angle of the relative direction. However, students insistently give it as 45 degrees, which shows the application of a “blackboard geometry”, in which almost always simple whole values of angles are obtained in vector sums.

The answers to the former questions show to us that, in solving problems involving relative velocities, there is a sharp distinction between one and two dimensions. In one dimension, nearly all the students obtain the correct answers, as long as the solution requires implicitly to use the student’s own frame of reference. But, if a change of reference system is required, the answer is incorrect in roughly half the cases, because the student is reluctant to change his system of reference, and place himself in a different one.

The student has difficulties in case he is asked to change the reference system to one different to his own. The response he usually gives is based on thinking that the direction of the velocity in relative motion is that which is observed from the moving body. In this case, our observation is that the student prefers to use a system attached to the moving body; this is the only one used for every case, and to it he refers any question about relative motions.

In the personal interviews with students, we found that they prefer a mathematical solution from vector equations, since in that case they do not need to imagine the physical situation. This is tantamount to say that they are not interested in the conceptual comprehension of the problem, only in getting the solution asked by the teacher. Furthermore, we think that they do not understand the physical analysis, but rather learn by heart the mathematical analysis.

Summarizing: the most evident obstacle that is faced by the student is that of the “fixed coordinate system” attached to his person or to the moving body, of which we have to obtain its relative velocity. So that rather than “pre-Galilean” we have “anthropocentric” students, because they do not conceive a system not linked to them, and that there can be another more suited to their purpose. They do not even realize that the problem and source of contradiction of their analysis consists in not being able to visualize the problem from a different standpoint.

In this kind of conceptual research, the student’s answers are context-dependent [McDermott, 1984], because an interview is not the same as questions with laboratory demonstrations. In our case, questions and answers are written, because of the structure of the course.

Personal interviews allow us to go deeper into the students’ conceptions. On the other hand, it is interesting to remark that the percentages of correct answers are similar in both universities, which have different characteristics, which was to be expected, given the fact that we are facing a cognitive obstacle.

That obstacle is not well understood, and teachers do not realize it exists at all, and it rather reminds us of an epistemological obstacle. In another paper yet to be published, one of the authors [Bastien, 2010] has determined that there are cognitive obstacles that prevent a correct solution of problems.

These conclusions are in turn the starting point to a more detailed research, in which we expect to verify the student’s point of view, and understand the difficulties he has to solve problems on relative velocities. The authors are working on an active learning strategy, to fall on the subject of “personal” reference systems, to overcome this obstacle in our students.

Monaghan, J. M. Clement, J. (2000). Algorithms, Visualization, and Mental Models: High School Students’ Interactions with a Relative Motion Simulation. *Journal of Science Education and Technology*, Vol. 9, No. 4:311-325.

McDermott, L. (1984). Research on conceptual understanding in mechanics. *Phys. Today*, July: 24-32.

Saltiel, E., Malgrange J. L. (1980). ‘Spontaneous’ ways of reasoning in elementary kinematics, *Eur. J. Phys.* 1, 73-80.

**Sample of the quiz on relative speed answered by the students:**

PLEASE ANSWER THE FOLLOWING QUESTIONS:

Data for questions 1 and 2:

A car is moving in a straight line towards the North at 75 Km/h. Assume you are riding a bicycle behind the car, moving in the same direction at 25 Km/h.

1. Which way is the auto moving in relation to you?

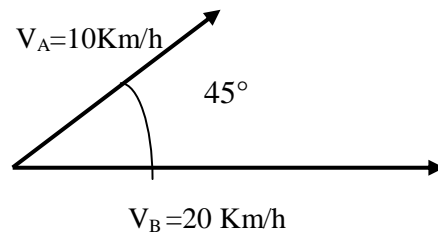
- a) North      b) South      c) it's in a fixed position      d) I don't know.

2. Which way are *you* moving as seen from the car?

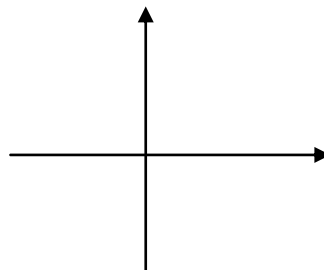
- a) North      b) South      c) I'm in a fixed position      d) I don't know.

3. A truck, loaded with bricks, with velocity  $v$ . Accidentally, one brick falls to the ground. Draw a *qualitative* sketch of the movement the brick performs, as seen by somebody standing in the street.

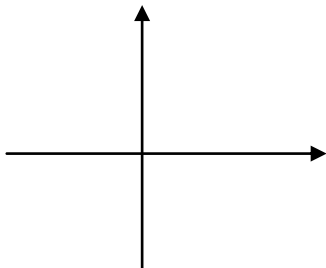
For questions 4 and 5, look at the next drawing:



4. Assume you are on ship B. Draw the vector showing the movement of ship A, as seen from B.



5. Now, assume you are in ship A. Draw the vector showing the movement of ship B seen from A.



# **The Concept of Electromotive Force in the Context of Direct-Current Circuits. Students' Difficulties and Guidelines for Teaching**

**Jenaro Guisasola<sup>1</sup>, Isabel Garzón<sup>2</sup> & Mieke De Cock<sup>3</sup>**

<sup>1</sup>EHU. University of the Basque Country. Spain, [jenaro.guisasola@ehu.es](mailto:jenaro.guisasola@ehu.es)

<sup>2</sup>UPN. Pedagogic National University. Colombia,

<sup>3</sup>LESEC, Katholieke Universiteit Leuven . Belgium

## **Abstract**

Our work deals with the difficulties which arise at university level in the analysis of the operation of simple direct current circuits which includes the concepts of energy and electrical current. The final aim of this study is to identify students' difficulties in learning the concept of electromotive force in the context of direct current circuits, which could provide a set of guidelines for designing teaching sequences. In order to investigate students' difficulties in understanding, a questionnaire based on an analysis of the theoretical and epistemological framework of physics was used. It was administered to first year engineering students from Spain, Colombia and Belgium. The results of the study show that students' difficulties seem to be strongly linked to the absence of an analysis of the work carried out on the circuit and its energetic balance. Most university students do not clearly understand the usefulness of concepts of potential difference and emf. This leads to the necessity to design tasks and problems which provide opportunities to understand an energetic model which involves the concepts of potential difference and electromotive force.

## **1. Introduction**

Our work deals with the difficulties which arise at university level in the analysis of the operation of simple direct current circuits which includes the concepts of energy and electrical current. Mulhall et al. (2001) conclude that teachers have problems describing energy transformations in a circuit within a coherent framework and admit that they do not have a qualitative idea of the concept of potential difference and tend to avoid it in their explanations. The final aim of this study is to provide a set of guidelines for designing teaching sequences to serve as guidance in teaching the interpretation of energy and proof of the movement of charges between two points in a circuit and throughout all the circuit.

A set of interrelated reasons has converged in the choice of the topic of electromotive force (emf) in the context of Electricity, about the teaching-learning of which there is little research (Guisasola et al. 2005). Firstly, this notion is included in Secondary School programmes (age 16-18) and first-year engineering and science university courses. Secondly, it is a basic prerequisite for explaining the functioning of a direct current circuit and its technological applications.

There are several studies on students' understanding of concepts such as potential difference and current intensity in electric circuits. Many are based on the experience of instructors who have pointed out problems with how this material is typically taught (Stockmayer & Treagust, 1994). Psillos (1998) points out that "In our case, we decided to extend the experimental field to include not only steady states but evolutionary situations as

well; to commence conceptual modeling by voltage and energy, introducing these concepts as primary and not relational ones; to present a hierarchy of models capable of answering progressively sophisticated questions”. There have been also some empirical investigations on the students’ difficulties on understanding interpretative models of electrical circuits. Those developed at university level have principally focused on students’ understanding of the role played by potential difference and current intensity (McDermott, 1993).

Several textbooks point that to move charges between two points of a conducting wire a potential difference must exist between the two points of the wire. One way to generate a potential difference is to separate charges of different polarity within a spatial area. In direct current circuits, this is realised by the battery. In this context of simple electrical circuits, the emf is a property that quantifies the energy delivered to the charge unit by the electrical generator. A series of “non-conservative actions” takes place in the battery, through which energy is delivered to the charge unit and this energy is quantified by means of the property 'electromotive force' (Chabay & Sherwood 2002). Therefore, it is the “work done” to produce and maintain the electrical current which determines its relevance to the analysis of the movement of charges in a simple continuous current circuit. Whereas the potential difference measures the work ‘used up’ by the charges when moving from one point to another in a circuit (work carried out by conservative forces), the emf measures the work carried out by the generator to generate a potential difference by separating charges (work carried out by non-conservative forces) (Guisasola & Montero 2010) . We incorporated the results of these previous studies into our questions for studying students’ difficulties on understanding emf.

The present study adds to prior research by examining students’ understanding of the concept of emf in Electricity at introductory physics courses for science and engineering degrees. Students’ levels of understanding of electromotive force in Electricity are investigated. Levels of understanding are described here for two particular phenomena, involving transitory movement of charges such as the transitory state before the current becomes the same in the whole circuit and stationary state of movement of charges in an electrical circuit. We considered simple situations of circuits, because these situations are not mathematically complex, which might mask conceptual difficulties. The focus in this study is on the description of undergraduate students’ understanding as data on which teachers can base their decisions about intervention to coach students learning. The data also indicate ways to design teaching sequences and to measure the development of conceptual understanding.

### **3. Context of the research and methodology**

To find out what undergraduate students have understood about the concept of emf in Electricity, engineering and physics students from Spain, Colombia and Belgium, were given a questionnaire after they had studied the subject in class. The research was carried out at the University of the Basque Country, at the Pedagogic National University and at the Katholieke Universiteit Leuven over the last two years. All first-year students had done, at least, two years of physics at high school and they passed the national standard exams in Spain and Colombia to come to the University for studying science or engineering. First year Spanish students received 3.5 hours of lectures and 2 hours in the laboratory per week for 14 weeks (second semester) for electromagnetism. Electrostatic and electrical circuits are taught for 5 or 6 weeks of this course. In Colombia, there were 3 hours of lectures and 3 hours in the laboratory per week for 15 weeks (third semester) for electromagnetism I. Electrostatic and electrical circuits are taught for 8 or 9 weeks of this course. In Belgium, students had 4 hours

of lecture a week, and 2 hours of recitation (10 weeks). Lectures were given by experienced teachers of the Physics Department.

The students' answers of the questions were subjected to rigorous analysis. One member of the research team derived a draft set of categories of description for each question, based on reading the students' answers. That researcher then reread the students' answers and made tentative allocations of each answer to one of the draft categories. The other researches carried out the latter task independently. Once the answers were classified, the allocations of answers were compared. The original categories were redefined until a consensus was reached. When there were disagreements about category description or allocations of answers, these were resolved with reference to the answers as the only evidence of students' understanding. The focus was on the students' understanding, taking the students' answer as a whole, rather than on the occurrence of particular statements corresponding to a specific category description. An iterative process was used to produce final descriptions of categories that reflected the similarity in understanding among the answers allocated to each category and the differences among the categories.

#### 4. Experimental design

We designed four questions to assess the students' understanding on emf. The first two questions dealt with transitory movement of charges in an electric circuit context. These questions required students to recognize that the work done by mechanical forces is measured by the quantity of electromotive force. The other two questions involved the analysis of direct current electric circuits.

The questions were given to first-year engineering students at the University of the Basque Country (N=64) and at the Katholieke Universiteit Leuven (N=87), and to first-year physics students at the Pedagogical National University (N=50). All questions are presented.

Q1 & Q2: These questions deal with examples of the use of emf in a context different from the electrical circuit (piezoelectric effect - Van de Graaff generator). Students were asked whether the concept of emf is useful in these contexts and to explain what the use is. The aim of both questions was to investigate student understanding of the concepts of potential difference and emf within a context not explicitly connected to the normal teaching of electrical circuits.

**Q1.** If a force is applied on two opposing sides of a quartz crystal, charges are redistributed leading to a potential difference. The working of kitchen lighters, producing electrical sparks to start gas combustion, is based on this phenomenon.



We want to use this effect as a source of emf. However, a student argues: 'This effect cannot be considered as a source of emf, because the charge separation and potential difference are caused by a mechanical force.'

Is the argument valid? If so, explain carefully why. If not, explain the error(s) carefully and correct them.

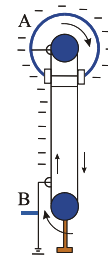


In order to answer correctly, students should know that the mechanical work done on the glass sides produces a separation of charges and a potential difference, and this work is measured by the electromotive force quantity.

**Q2.** As you already know, the Van der Graaff generator is a device that, by means of rubbing a rubber belt (in zone B), separates charges into two zones of the generator. It accumulates negative charge in the metal sphere (zone A) and positive charge in zone B (see diagram).

When a conducting wire is fitted between zone A and zone B, there is electrical current.

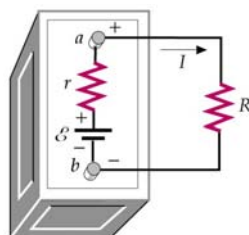
Is right to apply the electromotive force concept in this phenomenon? Justify your answer.



Students should use the definition of electromotive force to analyse the question. The mechanical work done by the Van der Graaff generator for separating charges and producing a potential difference is measured by the emf. So it is useful and correct to apply this concept for measuring the transference of energy produced in the phenomenon.

**Q3:** The third question was connected to the energy balance of an electrical circuit made up of a battery, cables and bulbs or resistances.

**Q3.** A resistor  $R$  is connected to the terminals of a battery with negligible internal resistance  $r$ . Explain which of the three options given below describes the circuit's energy balance: a)  $\Delta V = I R$ ; b)  $\varepsilon = I R$ ; c) both.



The correct answer may be explained by using the second Kirchhoff law (conservation of energy in the circuit) which is expressed mathematically by the equation  $\varepsilon = \Delta V + I r$ . As there is no internal resistance in the battery,  $\varepsilon = \Delta V = I R$ , the equations a) and b) obtain the same value, but from this result it cannot be inferred that  $\varepsilon$  and  $\Delta V$  are the same concept. In the contraire, the electromotive force concept and the potential different concept measure two different effects. The electromotive force concept measures the work per unit charge, done by non-Coulomb forces in the battery for separating charges and supplying energy to all circuit, whereas the potential difference potential concept is related to the work per unit charge done by Coulomb forces in the external part of the circuit. So the correct answer is the answer b).

Q4: This question was connected to the energy balance of a circuit made up of a battery, cables and bulbs or resistances. The aim of the question is to differentiate between the emf and the potential difference in a simple dc circuit.

**Q4.** If the same battery is connected to different circuits, which quantity remains constant: the potential difference between its terminals or the battery's electromotive force? Explain.

In order to explain the electromotive force correctly, students should recognize that the potential difference measures the work used up by the charges when moving from one point to another in a circuit (work carried out by electrical conservative forces), while the emf measures the work carried out by the generator to create a potential difference by separating charges (work carried out by non-conservative forces). So, the emf concept is a characteristic of the battery and it remains constant if the battery is the same.

## **5. Results and discussion**

The results obtained in the three samples for the four questions will be presented. In the discussion, we will identify some conceptual difficulties which seem common to many students. This description of the students' ideas will concentrate on some persistent specific difficulties and the interpretation thereof.

The results of the students' answers to the four questions are shown as percentages in table 1.



CATEGORIES	Q1			Q2			Q3			Q4		
	UPN (N=50)	EHU (N=64)	LESEC (N=87)	UPN (N=50)	EHU (N=64)	LESEC (N=87)	UPN (N=50)	EHU (N=64)	LESEC (N=87)	UPN (N=50)	EHU (N=64)	LESEC (N=87)
A. Correct understanding of the meaning of emf	6%	6,5%	2%	8%	8%	13%	10%	9,5%	5%	20%	15%	37%
B. alternative conceptions:												
B.1. emf as “force” which works for moving charges	50%	47%	8%	20%	17%	8%	8%	2%	12,5%	14%	17%	1%
B.2. Confusion between emf and potential difference	4%	15,5%	34%	6%	26,5%	11%	54%	53%	57,5%	22%	40%	16%
- Reasoning based on the formula							22%	33%	15,5%			
- Emf is the same as potential difference							20%	5%	17%			
B.3. Oms’ law represents the energy balance of entire circuit							12%	15%	25%			
C. Incorrect reasoning base on poorly assimilated knowledge they have remembered	18%	12,5%	31%	20%	18,5%	12%	20%	16%	11%	26%	14%	20%
C’. It is not used the concept of emf				16%	8%	45%						
C’’ If there is current, there is emf	6%	4,5%	3%	10%	11%	-						
D. No answer/ incoherent	16%	14%	22%	20%	11%	10%	8%	24%	9,5%	18%	14%	26%

**Table 1.** Results obtained in the questionnaire in the three universities



The detailed categories of description are described in what follows. In the category “Correct understanding of emf”, the focus is on the role played by the emf as a magnitude which measures the work done for reorganising the charges and producing a potential difference. Frequently, the electromotive force quantifies non electrical energy, put into play to separate charges and give a difference in voltage or non electrical energy which would produce variations in a magnetic field.

In the category B.1 “emf as “force” which works for moving charges”, emf is considered as a mechanical force. There is a focus in force concept and students give it the capability to do "work" to move charges

In category B.2 “Confusion between emf and potential difference” the emf is given the same properties as the potential difference, which leads to not distinguishing between the role played by emf and by potential difference in the context of electrical circuits. In this way, some students state that Ohms’ law describes the energy balance of the entire circuit. Sometimes, when there is no electrical circuit, it is considered that there is no emf.

In the category “incorrect analysis of emf” the focus is on not mentioning the role played by emf or using badly memorised definitions.

As situations are presented in different contexts, it is to be expected that arriving at the correct answer becomes more or less complicated for the students depending on the context. The description of the categories reflects these differences in the complexity of the assignment. For each question, there are at least three different categories of answers that include some type of consideration for the concept of emf and what is shown in table 1. There is a category in each question that includes all of the elements that correspond to an expert understanding of the concept of emf (category A).

A minority of students recognizes that emf is the quantity that measures work done by the device or the battery to supply electric energy (category A). The major difference between the correct answers depends upon the situation presented. In situations involving transitory movement of charges (Q1 and Q2) the percentage does not reach ten, while it increases up to 15-18% in situations involving electric circuits with a continuous flow. This, however, is a much lower percentage than what would be expected from students in their first science and engineering course after being instructed on the topic.

- *Electromotive force as a force that does work or as energy*

Questions Q1 and Q2 were designed to test the students’ thinking on the concept of emf in contexts different from that of the electric circuit with a battery. They were asked about the adequacy of analyzing the situation using the concept of emf. A significant number of responses associate electromotive force with a force that does work (category B.1). There is a minority associating emf with energy or the transformation of energy through the device or the battery. The percentage in this category of explanations shrinks to around 10% when the context is an electric circuit with a continuous current (questions Q3 and Q4).

- *Tendency to confuse the electromotive force with potential difference*

Two situations were designed (questions Q3 and Q4) that use a continuous current circuit to look into the students' justification for calculating the energy balance in the circuit. The questions cannot be answered without using the concept of emf. In this context, the tendency of the majority (category B.2) is to attribute the same characteristics of the concept of emf to the concept of potential difference, such that in the context of an electric circuit with a continuous current they provide no meaningful distinction between one concept and the other. For example, in question Q4 one student affirms, "in this case, talking about potential difference or emf is the same, since the reference is to energy it takes to move the electrons through the circuit". In response to the same question another student affirms "If we measure the extremes of the battery with a voltmeter we obtain its potential difference, yet at the same time that potential difference is the voltage of the battery, as in its electromotive force, since the electromotive force is a potential difference. Therefore, the two remain constant (they are same)". Some students attribute emf properties to potential difference and vice versa. For example "Potential difference remains the same because it is the same with all circuits, whereas the emf within the battery must increase in order to take all the circuits to the same potential difference; this is reflected in the increase in current that travels through each circuit".

In every question posed, the confusion between the properties of the concept of emf and those of potential difference (see category B.2 from table 1) shows up, although, in order to justify both concepts having the same physical meaning, the students use different strategic justification:

a) Justification based on the formula that attributes the same physical meaning to two different magnitudes that have the same value within a determined situation. The students trust more in the quantitative results of the equation than in the logical arguments based on facts. For example: "to conserve energy the energy balance of the circuit is determined by  $\epsilon - I r - IR = 0$ . As there is no internal resistance  $\epsilon = IR = \Delta V$ . Then the potential difference and the emf are the same to measure the energy from the circuit. So the correct option is c)"

b) Overgeneralization between situations with electric circuits and any other situation. Some students have the tendency to associate the concept of emf with situations involving an electric circuit with a battery and believe that it can only be defined under these conditions. For example: "the concept of electromotive force can only be applied in circuits with batteries or electric motors"

c) Functional fixation with Ohm's law. This leads the students to exclude a qualitative analysis to a problem that justifies the algorithm selected in the resolution. Some students considered Ohm's law to be something applicable not only to the parts with resistance, but to the entire circuit, and evaluate the energy balance of the entire circuit. For example, "Ohm's law represents the energy balance for the circuit. The correct option is c)".

- *The belief that potential difference produces electromotive force*

Throughout the entire questioning there is a growing tendency that when dealing with circuits with a continuous current, it is assumed that the battery or the Van der Graaff produces a potential difference and that this produces the electromotive force. This type of reasoning has been included in category C in table 1. Some students incorrectly assert that the battery produces a potential difference and that there is consequently an emf. For example, in

question Q4 a student explains that “the battery produces potential difference and this stays constant because if the circuit varies, the electromotive force varies since this is what does the work of delivering charges”.

Students’ difficulties seem to be strongly linked to the absence of an analysis of the work carried out on the circuit and its energetic balance. In this regard, most students still do not clearly understand the usefulness of concepts of potential difference and emf, not in situations involving transitory movement of charges and not in continuous movement. In all cases, we found evidence of a principal difficulty: the mistake of associating the concept of electromotive force with the quantity that measures the work done to supply energy to the entire circuit, both the exterior and the interior of the battery.

Those difficulties identified have direct implications for teaching. For example, much of the students’ difficulties in analyzing the role of emf is because they see it as a ‘force’ or an ‘energy’ that drives charges through the conductor cable. Lack of an adequate meaning for the concept of emf drives many students to confuse it with the concept of electric potential. Often the students attribute properties from the concept of potential difference to the concept of electromotive force and vice versa. Similarly, in situations with electric circuits with a continuous flow, to calculate the balance of energy in the entire circuit the students make a overgeneralization applying Ohm’s law to parts of the circuit with resistance.

## References

- Benseghir A. & Closset J.L.:1996, ‘The electrostatics-electrokinetics transition: historical and educational difficulties’, *International Journal of Science Education* **18** (2), 179-191.
- Guisasola, J. & Montero, A. (2010), An energy-based model for teaching the concept of electromotive force. Students' difficulties and guidelines for a teaching sequence. In G. Çakmakci & M. F. Taşar (editors) *Contemporary science education research: learning and assessment*. Pegem Akademi.. Ankara, Turkey , 255-258.
- Guisasola, J., Montero, A. y Fernández, M. (2005). Concepciones de futuros profesores de ciencias sobre un concepto ‘olvidado’ en la enseñanza de la electricidad: la fuerza electromotriz (Pre-service teachers’ conceptions on a concept ‘forgotten’ in the teaching of electricity: electromotive force), *Enseñanza de las Ciencias* 23(1), 47-60.
- Guisasola, J., Zubimendi, J.L., Almudi, J.M. & Ceberio, M. (2002) The evolution of the concept of capacitance throughout the development of the electric theory and the understanding of its meaning by university students, *Science & Education* 11, 247-261
- Guisasola, J., Furió, C. and Ceberio, M. (2008) Science Education based on developing guided research, Edited by M.V. Thomase in *Science Education in Focus* p. 55-85. Nova Science Publisher.
- McDermott, L.C. & Shaffer P.S., "Research as a guide for curriculum development: An example from introductory electricity, Part I: Investigation of student understanding." *Am. J. Phys.* **60** (11) 994 (1992); Erratum to Part I, *Am. J. Phys.* **61** (1) 81 (1993).
- Mulhall P., Mckittrick B. & Gunstone R. 2001. A perspective on the resolution of confusions in the teaching of electricity, *Research in Science Education* 31, 575-587.
- Psillos, D. (1998). Teaching introductory Electricity in *Connecting Research in physics Education with Teacher Education* vol. 1. Edited by Andrée Tiberghien, E. Leonard Jossem, Jorge Barojas. I.C.P.E. Book. On line in website: <http://www.physics.ohio-state.edu/~jossem/ICPE/E4.html>
- Ruth Chabay R. & Bruce S. (2002) *Matter and Interactions 2: Electric & Magnetic Interactions*. 3 edition. John Wiley & Sons
- Stocklmayer S. & Treagust D., (1994). A Historical Analysis of Electric Currents in Textbooks: A Century of Influence on Physics Education. *Science & Education* 3, 131-154.
- Tipler, P.A. & Mosca, G., 2004, *Physics for scientists and engineers*, Fifth edition, New York: W.H. Freeman and Company
- Watts, M, Gould, G. & Alsop, S., 1997. Questions of understanding: Categorising pupils’ questions in Science. *School Science Review*, 79, 57-63.



# Streamlining a sensor technology course in cadets' physics education by pre-evaluation

**A.J. Rissanen**

National Defence University, Department of Military Technology, Finland

[antti.rissanen@mil.fi](mailto:antti.rissanen@mil.fi)

**Abstract:** A specific sensor technology course is lectured at the National Defence University. This course is held in the 5th semester. To learn the fundamental principles of the selected systems basic concepts of physics are utilized in practice. The course is offered for the whole cadet course consisting of the majors in technology studies and also those, who have selected another discipline for their major subject. This study investigates how cadets' knowledge on physical phenomena can be improved in this application oriented course by evaluative diagnostics and connective interventions. The mission of the evaluation is to produce such feedback, which could direct and guide the development work in educational processes. In this study, pre-evaluation was utilized in a course enhancement and streamlining work. The pre-evaluative diagnostic test gave important information for the course developers, how to streamline the course structure and the contents to such direction that it will more properly fit the student profile. The summative post-test revealed that the streamlining procedures led from the diagnostic pre-test were mainly successful.

## Introduction

The *sensor technology course* is given at the 5th semester. This is the first basic theory course concerning sensor systems consisting of 72 studying hours which is equal to three credit points (3cu). In the course, according to university pedagogy principles, necessary mathematical skills and physics knowledge have been rehearsed during previous semesters. The upper learning objectives of the course are the skill to see limits and opportunities for applied technologies, skills to utilize physics concepts, and logical formulation of the presented phenomena. This study investigates how to formulate evaluative interventions to be implemented just before the course and when the course is over. The main aim was to offer data for course streamlining purposes. The sensor technology course is common for the whole cadet course consisting of the majors in technology studies and also those, who have selected another discipline for their major subject. The sample consisted of 24 majors in technology studies and of 72 non-majors. In the course principles of sensor technology are lectured from the view point of surveillance and target acquisition.

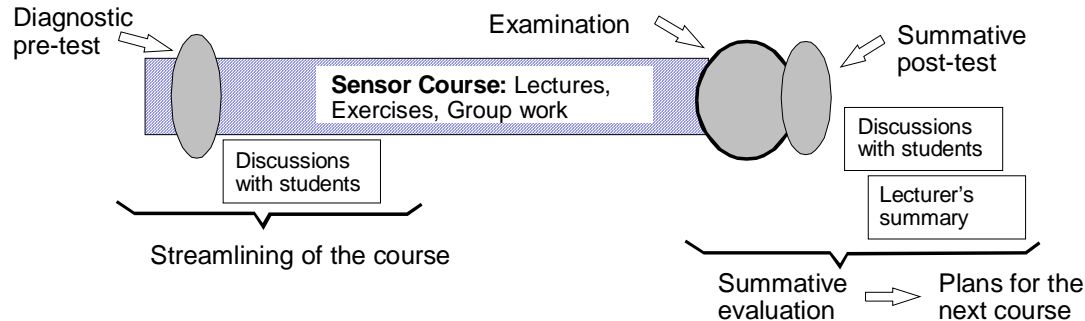
*University pedagogy* investigates both pedagogical activities in higher education context and in the discipline-specific context paying special attention to instruction, assessment, and to the ideas of alignment in the educational practice. According to the Bologna principles, a qualified education means that customer and process quality challenges must be considered widely. A valid assessment is fit for its purpose and measures things which it is supposed to measure (McAlpine, 2002). Fair assessment utilizes many different measures and emphasizes students' encouragement in this process (Suskie, 2000). In Biggs's (1999) constructive model three focus areas are emphasized, namely; learning outcome, assessment design and its intervention, and appropriate learning opportunities. In an instructional evaluation diagnostic evaluation declares the current status, formative evaluation supports planning and instructional activities, and a summative part enables decision making and conclusions (e.g. Black, 1997, Rose, 2009). Diagnostic tests have been used in order to gain a fuller understanding of students' grasp of the key concepts and constructing a reliable diagnostic test can be a lengthy and complicated process (Archer & Bates, 2009).

In evaluation *self-assessment* improves students' critical attitude toward their work making it more structured (Orsmond & Merry, 1997). However, many students cannot assess themselves accurately before the educational intervention takes place (Eva et al., 2004).

Hence the retrospective self-assessments correlate more closely with more objective ratings (Pratt et al, 2000). In most of the system-oriented courses earlier learned physics concepts are needed but the factual acquired knowledge level of the students may vary, especially if the course consists of majors and non-majors in subject. Therefore, course connected re-evaluation and streamlining may solve the mismatch. This is especially important in instruction concerning applicative physical principles, because previously learned concepts ordinarily form the bottom of the learning process for new concepts and their application. Such courses are challenging for teachers and students and make the role of course evaluation more critical.

## Research setting

The research is done according to the evaluative action research type approach. It included two tests which were conducted before and after the sensor course. The conducted study investigated students' physics knowledge level with the pre-evaluative and the summative post-test phases. The *diagnostic pre-test* in this study evaluated students' knowledge level before the course, as well as, their own opinions of their competence in this area. This pre-test was made during the course's first lecturing week. The results of this test were reinforced with the information gained from student-teacher discussions. The *summative post-test* was held immediately after the examination. It clarified students' overall satisfaction and was also utilized to evaluate the streamlining work. The formal course examination at the end of the course showed the factual gained knowledge level of the cadets. Together these two different sources form the feedback for the applied methods and strategies with the study group.



**Figure 1. Flow diagram in the project.**

## Diagnostic pre-test

### Methodology and data analysis

The diagnostic pre-test consisted of three parts; firstly the Likert-scale survey, secondly the combination test (a student combines the right values and the given statements together according to his understanding; *4 pairs*), and as a third part a test with true-false questions (the student answers if the presented argument is right or wrong; *7 arguments*). *The first part* investigated the cadet's own impression of the gained knowledge level (understanding of the common previously learned physical concepts), as well as his own opinion about experience of the connected tools and equipment (*14 areas*). Selected physics concepts were presented on

the survey e.g., properties of the electromagnetic wave and the principles of thermal radiation. Some practical skills related to those phenomena were asked e.g., experience on utilization of night vision device (e.g. NVG or thermal image camera) and utilization of some applied software products. Understanding of these concepts with practical skills and experience of connective tools and equipment would help to understand issues that deal with the sensor technology course. *The combination test and the true-false test* declared the cadets' actual knowledge level of the necessary concepts. The purpose of the pre-test was to reveal cadets' knowledge level, their own opinions of their competence, and differences in a focus group (majors versus non-majors in technology studies). The students were also asked to state their previous success both in theory based subjects and in military technology oriented subjects. After the pre-test a common informal discussion session was held with the cadets. From the session other expressed wishes were also recorded.

### Results of the pre-test

The study revealed no remarkable differences in the knowledge level between the major and non-major groups. However, the group of majors proved to be more homogenous. In the self-evaluative test the major reader group rated their understanding slightly better than in the group of non-majors. However, the part which declared students' factual understanding (combination test, true-false test) did not show any remarkable differences between the two groups. According to the pre-test, the following concepts or items were familiar to the students: e.g. luminescence for night vision (NV), thermal camera and experience with its use, image intensifier, and Geographical Information Systems (GIS). However, some concepts were challenging for some of the students: e.g. Maxwell's equation, Wien's transition law, and the blackbody radiation (Likert-scale) and concepts connecting to radiation and sensitivity (e.g. laser, sun, and human eye) (the combination test and true-false test).

### Course validation inspired by the pre-test

The conducted pre-evaluative test provided important information for the course developers, how to streamline the course structure, and contents to such a direction, that it will more properly fit the student profile. The pre-test revealed to the lecturer areas which needed more focused instruction. Two decisions were made: 1) it is worthwhile to make a rehearsal session on most of the needed physics concepts in the beginning of the course, 2) demanding issues, like cases connected to e.g., Maxwell's equations, Wien's transition law, blackbody radiation, and the propagation of electromagnetic waves needs enough time allocation in course program.

## **Conducted summative test after the course**

### Methodology and data analysis

The summative test was conducted immediately after the course examination. Combined with the examination results the summative test estimates how well the pre-test served selected instructional strategy. The summative test consisted of the *quantitative survey* (20 questions in Likert-scale) and the *qualitative part* (open question part). The quantitative part was used to study following issues: satisfaction with the instructional methods during the course (5 questions), perceived learning outcome (understanding of the selected concepts and tasks according to student's own opinion) (5 questions), perceived level of students' self-regulation

during the course (5 questions), cadets' satisfaction with the organizational arrangements (2 questions), and satisfaction with the instructional material during the course (2 questions). Table 1 combines topics in the quantitative part of the summative test.

Table 1. Interest areas of activity in the summative evaluation.

Group	Contents	Questions #
Learning outcome/ (self-evaluative opinion)	Radars, Measuring, Applied software, Black Body radiation, Learned new concepts, Applied tools and equipment	5
Instructional methods	Methods used at lectures, Methods supporting individual proceeding	5
Level of self-regulation (self-evaluative opinion)	Level of self-regulation in studies, Adoption of self-assessment techniques	5
Organizational arrangement	Satisfaction on course plan, framing & encouragement methods	2
Instructional material	Portal use during the course, Need of other products	2

The qualitative part was used for opinions. It was named as a space for comments and improvement proposals (open question part). It is known that multiple choice formats or detailed factual answers push students to a surface approach and open or essay-type questions encourage students to analyze their responses more deeply (Entwistle & Entwistle, 1991). The formal course examination test after the course grades cadets' actual gained knowledge level. The summative evaluative test declared cadets' own idea of the acquired knowledge and the quality of the course.

#### Results of the summative test

The quantitative part of the test showed that the cadets were most satisfied with the applied instructional methods in the course. Those questions which declared students' own opinions of gained understanding of the learned concepts (learning outcome) showed that the aims were gained reasonably when thinking the theoretic nature of the course. Issues linked with cadets' opinions on their self-regulative abilities (e.g., the independency level shown by cadets during the course) showed that the course implementation supported such activities. Questions connected to organizational arrangements pointed to further streamlining needs (see Figure 2).

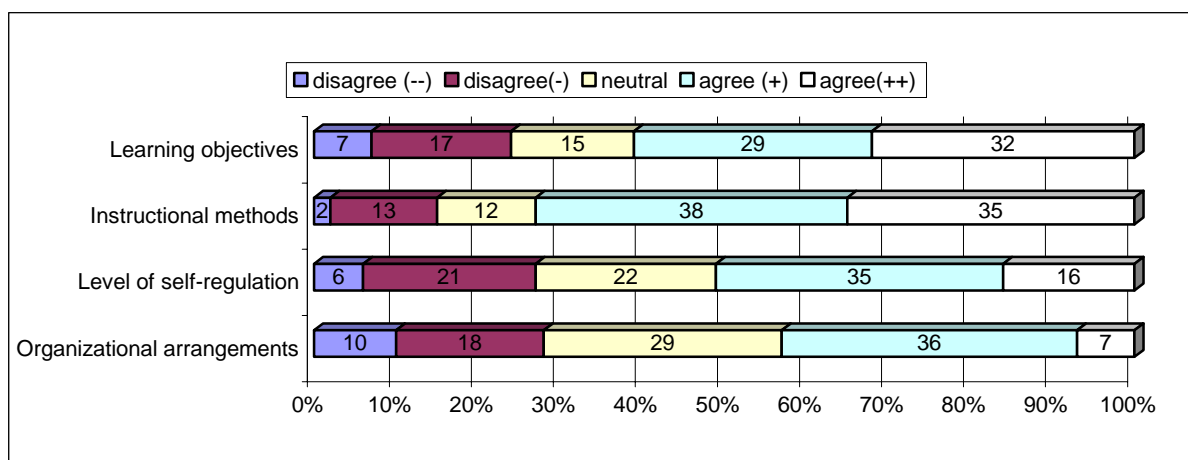


Figure 2. Results from the summative feedback (quantitative part).

Cadets appreciated versatile learning material packages. During the course they had in their use a course specific learning portal. The cadets utilized the given course portal and found it useful. About 80% of the students claimed that the portal use during the course could be wider, so that they could optimize better their personal time allocation. However 77% of respondents seemed to appreciate additional course specific printed hand-outs or course connected compact textbooks.

In a qualitative part of the test students presented their improvement proposals or remarks; they wanted e.g., that this sensor technology course could include more time allocation for calculation exercise sessions with a applied software or more exercises with complete model answers to be presented in the portal (Table 2).

**Table 2. Students' top improvement proposals for instructional practice**

Themes \*

1. More exercise sessions
2. More model answers in the portal
3. Some areas too theory emphasized
4. Also printed learning material besides portal use
5. More alignment with the portal and instruction
6. More simplifying cases at demonstrations.

\* (Qualitative part of the summative test)

### **Planned further interventions**

The analysis based on the summative test, the examination, and the pre-test showed a way for the future arrangements and guidelines for the next class. It seems that the learning portal is not enough; at least a separate course connected hand-out is needed. Also, more space for exercise sessions are probably needed in the course framing. According to the summative test, the general level of perceived student satisfaction was in order. Even though the standardized examination protocol is not yet ready, the results of the course examination showed that the selected strategies as such were useful. This means that the streamlining procedures before the course inspired by the pre-test were successful. However, the results showed that in the future course differentiation is not enough and it is useful to offer the course to the both level groups separately. In this way the attitudinal differences in groups can be controlled and smaller group sizes make more customized instruction possible.

### **Validity of the evaluation results**

The conducted diagnostic pre-test provided good indication of cadets' understanding of the common physical concepts which were needed during the sensor technology course. Because the test was designed to be relative compact, it revealed only the most critical aspects. However, it showed a rough estimate of the students' knowledge level and their self-evaluative opinions of their understanding of the selected physical concepts. The summative test as such tells more about students' perceived experience and opinions of the course than their factual, gained knowledge level. It is true that student satisfaction is a complex notion and all the connected factors are not related to the quality of teaching (Wiers-Jenssen et al, 2002). Therefore, these self-evaluative results complement the results of the formal course examination and the final evaluation utilized these both informative sources.

## Conclusions

Customer quality means that the opinions of cadets are both heard and also appreciated. Therefore, *the diagnostic evaluation (the pre-test)* provides value in the following ways: 1) for the course lecturers it gives more information concerning streamlining needs of the coming course and 2) for a student it gives a feeling that the offered course is more customized. Diagnostic tests can be utilized in customizing a specific course for a certain group. As an example, the tests are valuable to implement before such courses, in which the knowledge level of students may vary. With aid of this knowledge, a teacher can emphasize and rehearse such concepts which are less familiar. Often in practice, the results from the examination at the end of the course are considered to fill the need of summative evaluations. However, a formal examination tells about the learning results but gives no indication of the students' overall satisfaction and perceived quality of the course. Versatile and specifically designed summative tests will offer more information to course developers than traditional examinations alone making the development work more focused and customer driven. Feedback should be provided to students on assessed work (QAA, 2001). Hence, it is useful that different surveys or evaluative procedures would be completed by interactive, informal discussion sessions with students and lecturers. This kind of session can also reveal such cues which are difficult to capture with formal evaluative methods. Also unclear issues can be discussed more specifically, as well as, to hear students' first impressions of the intended improvement proposals.

## References

- Archer, R. & Bates, S. (2009). Asking the right questions: Developing diagnostic tests in undergraduate physics. *New Directions*, 5, 22-25.
- Biggs, J. (1999). *Teaching for quality learning at university*. Buckingham: SRHE/OUP.
- Black, P. (1997). Evaluation and assessment. In A. Tiberghien, E. Jossem, & J. Barojas (Eds.). *Connecting Research in Physics Education with Teacher Education*, International Commission on Physics Education.
- Entwistle, N. & Entwistle, A. (1991). Contrasting forms of understanding for degree examinations: The student experience and its implications. *Higher Education*, 22, 205-227.
- Eva, K., Cunnington, J., Reiter, H., Keane, D., & Norman, G. (2004). How can I know what I don't know? Poor self-assessment in a well-defined domain. *Advances in Health Sciences Education: Theory to Practice*, 9, 211-224.
- McAlpine, M. (2002). *Principles of Assessment*. The CAA Centre TLTP Project, HEFCE.
- Orsmond, P., Merry, S., & Reiling, K. (1997). A study in self-assessment: Tutor and students' perceptions of performance criteria. *Assessment and Evaluation in Higher Education*, 22(4), 357-369.
- Pratt, C., McGuigan, W., & Katzev, A. (2000). Measuring program outcomes: Using retrospective pretest methodology, *American Journal of Evaluation*, 21, 341-349.
- QAA (Quality Assurance Agency). (2001). *Code of practice: Assessment of students' general principles*-Quality and Standards in HE.
- Rose, L. (2009). Students as researchers: a framework for using action research principles to improve instruction. *International Journal of Teaching and Learning in Higher Education*, 20(2), 284-291.
- Suskie, L. (2000). Fair assessment practices: Giving students equitable opportunities to demonstrate learning. *Fair Assessment Practices*. AAHE Bulletin May 2000.
- Wiers-Jensen, J., Stensaker, B., & Groggaard, J. (2002). Student satisfaction: Towards an empirical deconstruction of the concept. *Quality in Higher Education*, 22, 33-53.

### 3.3 – Modern and contemporary physics

---

## **School Inquiries Based on Soft Elastomer Lithography**

Anssi Lindell<sup>1</sup>, Anna-Leena Latvala<sup>1</sup> and Jouni Viiri<sup>1</sup>

<sup>1</sup>Department of Teacher Education, University of Jyväskylä, Finland

E-mail: [anssi.lindell@jyu.fi](mailto:anssi.lindell@jyu.fi)

We have used polydimethylsiloxane (PDMS) and also tested other polymers as a material for a set of school science inquiries based on soft lithography. In soft lithography, polymers are used instead of conventional rigid photo masks for lithography. These may be used as stamps, molds or masks to generate mesoscopic patterns and structures for small devices. The advantages of soft lithography over traditional photolithography make it ideal in the boundary conditions of school science. Soft lithography does not require expensive clean room processes or instruments; a standard school laboratory is enough. The materials to be processed can be chosen for safety and cost. Soft lithography allows for three-dimensional structures on three-dimensional substrates with a large variety of materials with interesting chemical, biological and physical properties to study at school.

We took advantage of the mouldability, elasticity and transparency of PDMS in designing three school inquiries. First, we fabricated elastic replicas of a commercial optical grating with 1000 slits/mm. If the elastic replica is stretched parallel or perpendicular to these grooves, the spacing between them i.e. the grating constant decreases or increases respectively. The elastic gratings may be used as dynamometers, pressure gauges or strain gauges. The second inquiry we demonstrate is an elastic lens. It is a liquid-filled circular PDMS pocket whose curve radius and focal length can be adjusted by changing the volume of the liquid inside the pocket. Personally adjustable eyeglasses are an application for this. The third inquiry uses PDMS as a stamp to fabricate physically, chemically and biologically controlled active patterns on a substrate. Electrical components, etching masks and cell cultivation pads are examples of these.

The learning objectives were defined for the three school inquiries and experimental setups were constructed and tested for the elastic optical grating and the liquid filled lens experiments.

### **Introduction**

In the long run it will be profitable to teach nanoscience in schools. First, the world market for nanotechnological products will grow to a trillion US Dollars by 2015, and an increase of 2 million manufacturing jobs related to nanotechnology is expected [1]. Second, nanoscience offers fascinating opportunities to increase the piquancy of science lessons as it challenges traditional models of science with achievements of modern technology.

However, there are barriers in adopting new contents to science education. Bamberger and Krajcik [2] reported that science teachers in USA designated the lack of knowledge, time and teaching materials as reasons which suppress the integration of nanoscience into their classes. Other barriers of integrating technology into curriculum are the price of instruments, devices and facilities needed for typical nanoscience experiments. For lowering these external barriers [3], we designed three low budget nanotechnology-oriented inquiries for physics courses at high schools and universities. The focus of the two first experiments is in applied optics and mechanics. The third introduces interdisciplinary techniques to deposit structures on surfaces using elastic stamps.

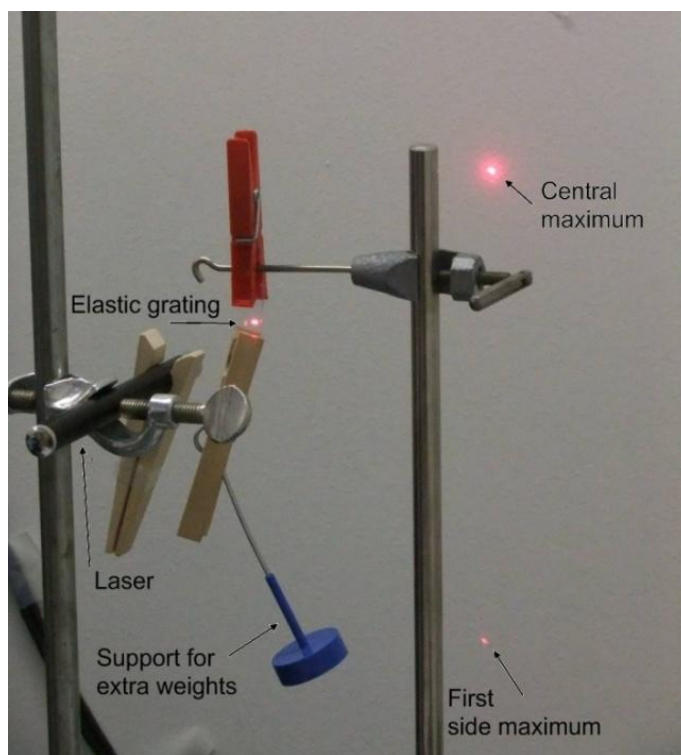
The experiments take advantages of Polydimethylsiloxane (PDMS) soft lithography. Soft lithography is a technique based on replica molding and self assembly of organic molecules [4].



PDMS is a two-component elastic and transparent mouldable polymer that is widely used for biomedical applications, such as implants, as it is biocompatible, flexible, and can adapt itself into chemically and geometrically challenging organic environments like the human body [5]. The micro- and nanoapplications range from micro capillary channels, pumps and valves to electrophoresis, micro reactors and integrated lab-on-chips [6]. It is also an excellent material for school inquiries and demonstrations, as it is cheap and safe to use. The elasticity and transparency suggests using it for experiments combining optics and mechanics. The mouldability makes it possible to tailor individual geometries for devices or, on the other hand, make several identical replicas of one device.

### An elastic optical grating

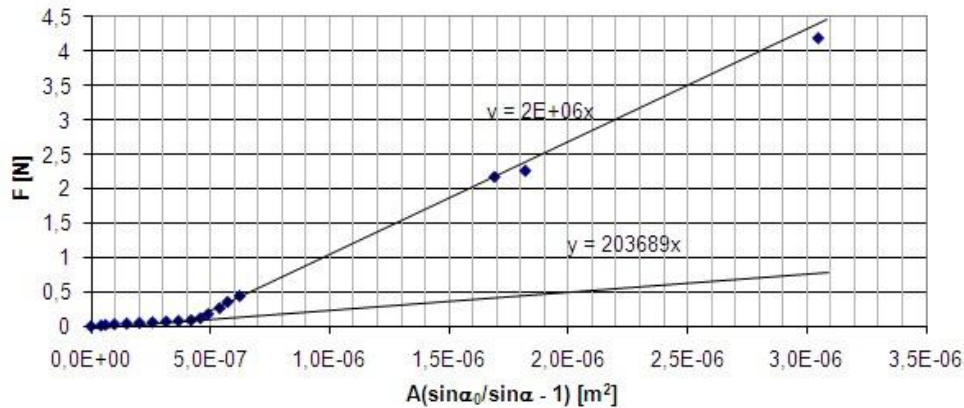
The first inquiry is based on diffractive optics. We used PDMS to fabricate elastic replicas of a rigid commercial optical grating with 1000 slits/mm, as described in detail in [7]. Figure 1. shows the experimental set-up used in our classes. The grating was hung from a clothespin and illuminated by a red He-Ne laser (wavelength 632 nm). A support with extra weights was hanged by another clothespin into the opposite end of the grating to stretch it by definite forces. The shift of the diffraction maxima can then be measured to determine grating constant, strain and Young's modulus of the material.



**Figure 1** An experimental set up for an elastic optical grating inquiry. The weight of a clothespin (10 g) and a support for extra weights (50 g) have stretched the elastic grating and thus caused the shift of the first diffraction side maximum towards the central maximum.

A typical result of this experiment is plotted in Figure 2. The elasticity of the grating shows two linear regions. The Young's modulus obtained from the first linear region, about 200 kPa is

probably due to recoiling of molecules (not studied in this particular experiment), and that from the second part is 2 MPa.

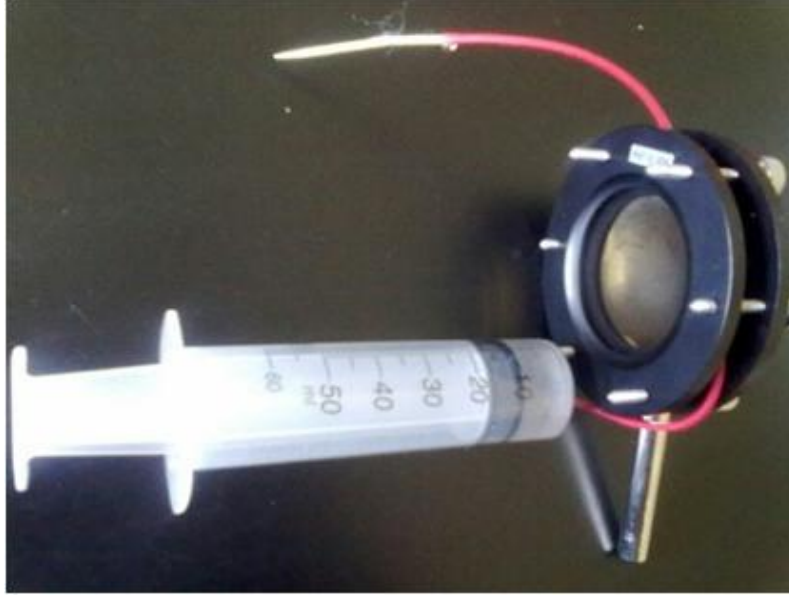


**Figure 2.** Plotted experimental data for stretching originally 0.5 mm thick, 11.5 mm wide and 15 mm long elastic PDMS grating.  $F$  is the stretching force,  $A$  is the cross sectional area of the grating and  $\alpha_0$  and  $\alpha$  are the angles of diffraction for unstretched and stretched grating respectively [7]. The linear regions give Young's modulus of 200 kPa for low stress region and 2 MPa for high stress region.

The two linear regions in the curve makes this inquiry ideal for teaching students to test and not just apply models, as students typically do in their experimental work. This was also the case with force versus strain characteristics, where students took Hooke's law granted and measured only one or two data points to determine Young's modulus for PDMS material. This is a typical process for solving text book end of chapter problems. However, it does not show any ability of testing models and doing science, which are essential parts of learning science [8, 9]. Using this inquiry with an elastic optical grating we are able to explicit instruct our students to put models to the proof and test their limits while doing experiments. Another main learning objective for this inquiry is applying diffractive optics and mechanics in an innovative way. In addition, students have an opportunity to test the different predictions of the geometrical and wave models of light. According to the geometrical model, the pattern of the slits of the optical grating should spread on the screen as the grating is stretched. However, the diffraction pattern on the screen gets narrower as the grating constant increases due to the stretching.

### A liquid-filled elastic lens

The second inquiry deals with geometrical optics. We molded thin PDMS membranes and mounted them on both sides of an O-ring to make a lens with adjustable central reservoir. The refractive power of the lens can be tuned by pumping liquid into or out of this reservoir by a syringe (see Figure 3). When the volume of the liquid inside the lens reservoir is changed from the flat lens volume by  $\Delta V$ , the PDMS membranes bulge either outwards ( $\Delta V > 0$ ), making a biconvex lens, or inwards ( $\Delta V < 0$ ), making a biconcave lens.



**Figure 3.** An elastic liquid filled lens made of two PDMS membranes and an O-ring washer. The syringe is used to pump liquid inside and out of the device to adjust the lens from biconvex to biconcave respectively. The tube on the top of the lens is for removing air. It is capped after first time filling.

Assuming a spherical profile for this bulge, the lens curvature  $R$  is related to the increase of the volume by the equation

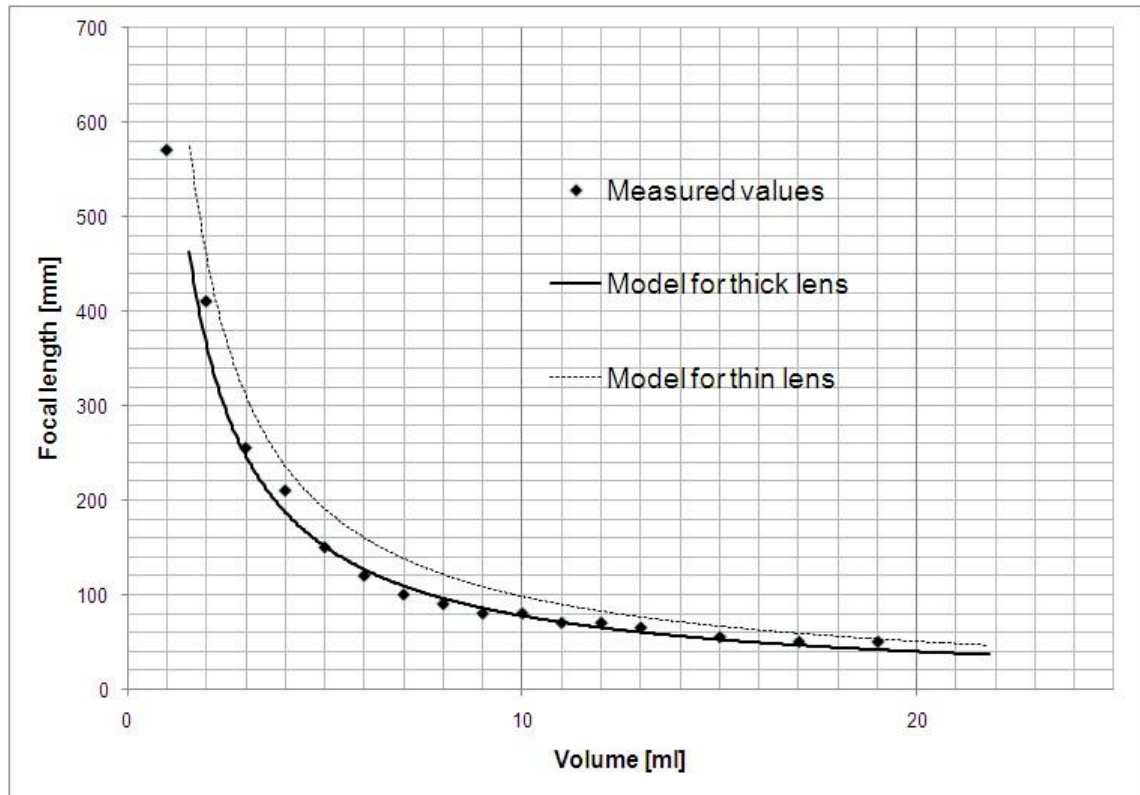
$$\Delta V = \frac{2}{3}\pi\left(2R^2 - r_0^2 - 2R\sqrt{R^2 - r_0^2}\right)\left(2R + \sqrt{R^2 - r_0^2}\right),$$

where  $r_0$  is the radius of the lens aperture. The focal length  $f$  of the lens can then be related to the change of the volume by lensmaker's equation, assuming a thin lens or using thick lens model:

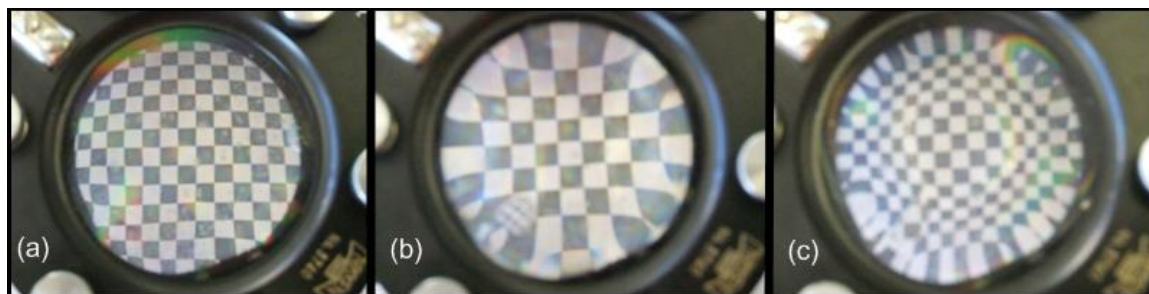
$$\frac{1}{f} = (n-1)\left[\frac{1}{R_1} - \frac{1}{R_2} + \frac{(n-1)d}{nR_1R_2}\right],$$

where  $n$  is refractive index of the liquid used and  $d$  is the thickness of the lens. For the case of water ( $n = 1.33$ ) and a double convex lens (where  $R_1 = -R_2 = R$ ), we measured the focal length of the lens as a function of volume of water added into the reservoir of an originally flat lens. The result was also compared with the thin and thick lens models. A graphical plot of the results can be seen in Figure 4. The focusing behaviour of the flat, biconvex and biconcave lens is presented in Figure 5 a, b and c respectively.

Elastic lenses have been originally designed to for self adjustable eyeglasses for developing countries [10]. The main reason for developing this inquiry was to demonstrate the awesome social impact of methods of nanotechnology. The learning goals of this inquiry are geometrical optics, fluid mechanics and scientific models. A student examining liquid filled lenses need to consider several assumptions and simplifications to be able to calculate the radius of curvature and focal length of the lens as a function of the change in lens volume, for example. We may also fabricate one or the both sides of the lens of diffractive sheet of PDMS and thereby combine the concepts of geometrical optics and wave model for light.



**Figure 4.** A measured focal lengths for a liquid filled elastic lens as a function of water added to originally flat lens. The thin and thick lens models for the device are represented by a dashed and a solid line respectively.



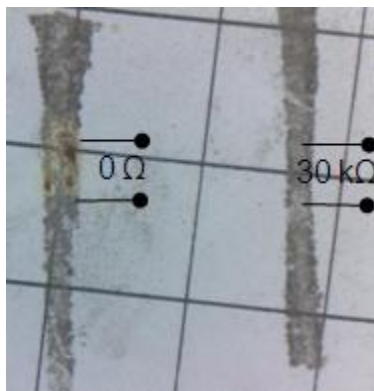
**Figure 5.** Focusing a chessboard pattern with a liquid filled lens. The lens is flat ( $\Delta V = 0$ ) in (a), biconvex ( $\Delta V > 0$ ) in (b) and biconcave with a flat central region ( $\Delta V \ll 0$ ) in (c). The aperture of the lens is 50 mm and the thickness of a flat lens in (a) is 5 mm.

### PDMS stamp

The development of the third inquiry is still in progress. The basic idea is an interdisciplinary experiment using elastomer stamps for sample fabrication. Students draw the structures they want to fabricate on an aluminum foil using a pencil or a wooden stick, for example. The resulting aluminum relief can then be used as a master for casting liquid prepolymer PDMS. The cured polymer can be used as a stamp to deposit chemically protective, so-called "resist", film patterns on metal film. These patterns may be lines or double lines to fabricate components such as resistors or capacitors respectively, after etching the unprotected metal away.

Another method that we tested is to use an edge of an eraser to make glue lines on a sheet of paper. After sprinkling aluminum powder on these lines, we obtained conductive lines with a sheet resistance of about 10 k $\Omega$ /square (see Figure 6). Then we sintered the lines applying a voltage of approximately 5 V/square across them reducing the resistance almost to 0  $\Omega$  as described in [11]. The two techniques described above may also be combined to demonstrate simple static memory circuits, for example.

Yet another possibility is to control cell shape, growth and function by patterning proteins using PDMS stamps as described in details in [12]. The PDMS stamp may be used to deposit methyl-group terminated alkanethiol self-assembled monolayers on protein resistant coated gold film, for example. Then, proteins adsorb only on this stamped pattern and, further, cells attach only on the protein coated areas.



**Figure 6.** Glue lines stamped on a paper by an office eraser have been sprinkled with silver powder. Applying a voltage of approximately 10 V sintered the powder causing the resistance decrease from original 30 k $\Omega$  to close to 0  $\Omega$ . One square in the paper is 1 cm<sup>2</sup>.

The learning objectives for inquiries by PDMS stamps range from understanding specific topics of physics (the difference between DC and AC impedance, for example), chemistry (selective etching and activation energy) and biology (the growth of biofilms and cells) to a wider understanding of interdisciplinary nature, methods and applications of nanoscience.

## Conclusions

Nanoscience is an important but not too easy topic to include in the school science classes. Science teachers must overcome many internal and external barriers. By this article we have tried to lower external barriers (i.e. expensive equipment, insufficient time to plan instruction, and inadequate technical support) of teaching nanoscience. Safe and inexpensive methods of soft lithography can be exploited to design school inquiries in nanotechnology. We have demonstrated here three inquiries based on PDMS polymer, but the easy and versatile technique allows also numerous other materials to be processed. This is important for schools where low cost and safety are determinative criteria for material selection.

The inquiries of liquid filled elastic lens and PDMS stamp techniques are under further development. We are also designing Predict-Observe-Explain [13] tests to be used in

investigations of students' understanding and ability to apply their skills in novel and often surprising situations combining several aspects of science.

## References

- [1] C. Palmberg, H. Dernis and C. Miguet, *Nanotechnology: An overview based on indicators and statistics*. OECD, STI Working Paper 7 (2009).
- [2] Y. Bamberger and J. Krajcik, *The role of teachers' barriers in integrating new ideas into the curriculum: The case of nanoscale science and technology*. Paper Presented in the Annual Conference of the National Association of Research in Science Teaching, Philadelphia, PA (2010).
- [3] P. A. Ertmer, *Addressing first- and second-order barriers to change: Strategies for technology integration*. Educational Technology Research and Development, **47**(4), 47-61 (1999).
- [4] X-M. Zhao, Y. Xia and G. M. Whitesides, *Soft lithographic methods for nano-fabrication*. J. Mater. Chem. **7**(7) 1069- 1074 (1997).
- [5] D. B. Weibel, W. R. DiLuzio and G. M. Whitesides, *Microfabrication meets microbiology*. Nature Rev. Microbiol. **5** 209–218 (2007).
- [6] T. Fujii, *PDMS-based microfluidic devices for biomedical applications*. Microelectron. Eng. **61**, 907–14 (2002).
- [7] G. Planinsic, A. Lindell and M. Remskar, *Themes of nanoscience for introductory physics course*. Eur. J. of Phys. **30**, S17-S31(2009).
- [8] D. Hodson, *Re-thinking old ways: towards a more critical approach to practical work in school science*. Studies in Science Education, **83**, 163-177(1993).
- [9] R. Justi and J. K. Gilbert. *Teachers' views on the nature of models*. International Journal of Science Education, **25**, 1369-1386 (2003).
- [10] K. Harmon, *Designer Focuses on Marketing Adjustable Eyeglasses at \$1 a Pair*, Scientific American, 24 (2009).
- [11] A. Alastalo, T. Mattila, M. L. Allen, M. J. Aronniemi, J. H. Leppäniemi, K. A. Ojanperä, M. P. Suhonen and H. Seppä, *Rapid electrical sintering of nanoparticle structures*. Mater. Res. Soc. Symp. Proc. 1113, 2-7 (2009).
- [12] R. S. Kane, S. Takayama, E. Ostuni, D. E. Ingber and G. M. Whitesides, *Patterning cells and proteins using soft lithography*. Biomaterials **20**, 2363-2376 (1999).
- [13] R. White and R. Gunstone, *Probing Understanding*. (RoutledgeFalmer, London, 1992).



# **Beliefs of Preservice Teachers regarding the Implementation of Topics of Modern and Contemporary Physics (MCP) in High School<sup>1</sup>**

Marcelo Alves Barros

*Physics Institute of São Carlos, University of São Paulo, Brazil*

[mbarros@ifsc.usp.br](mailto:mbarros@ifsc.usp.br)

Roser Pintó

*Departament de Didáctica de les Ciències, Universitat Autònoma de Barcelona, Spain*

[roser.pinto@uab.es](mailto:roser.pinto@uab.es)

Edson Cesar Marques Filho

*Physics Institute of São Carlos, University of São Paulo, Brazil*

[edson.cesar.filho@usp.br](mailto:edson.cesar.filho@usp.br)

## **Introduction**

In many countries a curricular innovation movement has been observed, such as the *National Science Education Standards* in the United States or the *Science Teacher Training in an Information Society (STTIS)* and *Material Science* projects in Europe, in which the emphasis is shifted from the needs of content to the needs of the learners, making them actively engaged in potentially relevant learning situations for them and which may be perceived as useful and important in their lives. In Brazil, in the last 15 years, a movement for curricular reform has highlighted the need to promote an education compatible with the rapid acceleration of the production of scientific knowledge and the understanding of new information technologies that influence society's means of production.

On the other hand, research in the area of Science Education has called attention to numerous difficulties faced by teachers when they implement curricular innovations in the classroom. Some works highlight that the involvement of teachers as a key-point for the success of a curricular innovation (Brown & McIntyre, 1978; McIntyre & Brown, 1979). They also call attention to the risks of non-adhesion and/or a failure to understand the proposed innovation on the part of the teachers (Fullan & Hargreaves, 1992). The possibilities of success increase significantly when the demand for change comes from within the teaching system, and is not seen by the teachers as an imposition of curriculum reformers (Terhart, 1999).

In this sense, despite the proposals for curricular reform, traditional teaching has remained resistant to the new changes and this is due largely to the knowledge and beliefs that the teachers have regarding the nature of their discipline, their personal and professional identity, as well as the teaching and learning of the specific contents (Pintó et al., 2001). The manner in which teachers learn to teach, what they know, how they acquire their knowledge, how they evolve over the course of time etc., are factors that cannot be ignored to

---

<sup>1</sup> With support from Fapesp and CNPq.

understand the causes of their difficulties in implementing a curriculum innovation in the classroom (Davis, 2003).

In this paper our objective is present a research focused on raising preservice teachers' beliefs with regard to the introduction of Modern and Contemporary Physics in the High School Curriculum.

### **Rationale**

Pajares (1992) summarized many findings on the study of beliefs in order to establish some basic guiding principles to guide further research in this direction: individuals' beliefs strongly affect their behavior, they are formed early and tend to perpetuate themselves even in face of contradictions caused by reason, time, experience or education and earlier a belief is incorporated, the harder it is to change it. Moreover, changes in beliefs during adulthood are relatively rare phenomena in which occur general and deep changes - 'gestalt shifts' – in someone. Individuals tend to cling to beliefs based on incomplete or incorrect knowledge even after scientifically correct explanations are presented to them; beliefs about teaching are already well established when a student arrives at university and those beliefs contribute to the definition of tasks and selection of cognitive tools with which to interpret, plan and make decisions regarding such tasks.

### **Methodology**

Our research methodology is of a qualitative nature (Bogdan e Biklen, 1994), of the case study type, and the data collection instrument consisted of semi-structured interviews carried out along this research. Our study group was originated from a group of 11 students on the Exact Sciences Teacher Training Course (specialty: Physics) of the Physics Institute of São Carlos, in the University of São Paulo/Brazil, in 2009. Finally, 4 preservice teachers were investigated depending on their availability to collaborate with this research. Their brief profile is exposed below.

Ana, 23 years old, has little interest in being a teacher and chose the teacher program due to its easy entry. Lia, 23 years old, always enjoyed Physics and Science but in the end of the teacher program she does not intend to be a teacher after giving lectures throughout the undergraduation. Roberto, 31 years old, always had empathy with the teaching of physics and he tried to reconcile the night availability of the teaching program to their need to work. He wants to be a teacher in the future, although it is already official. Saulo, 41 years old, always enjoyed mathematics, electrical and mechanical objects and always wanted to be a physics teacher. He wishes to pursue the profession after undergraduation.

Ana and Lia participated in a mini-course on the subject of “Nanoscience” in which were developed the following topics: soft matter and phenomena at the nanoscale, fundamentals of Atomic Force Microscopy, fabrication of nanostructures with molecular control and operation of an organic device.

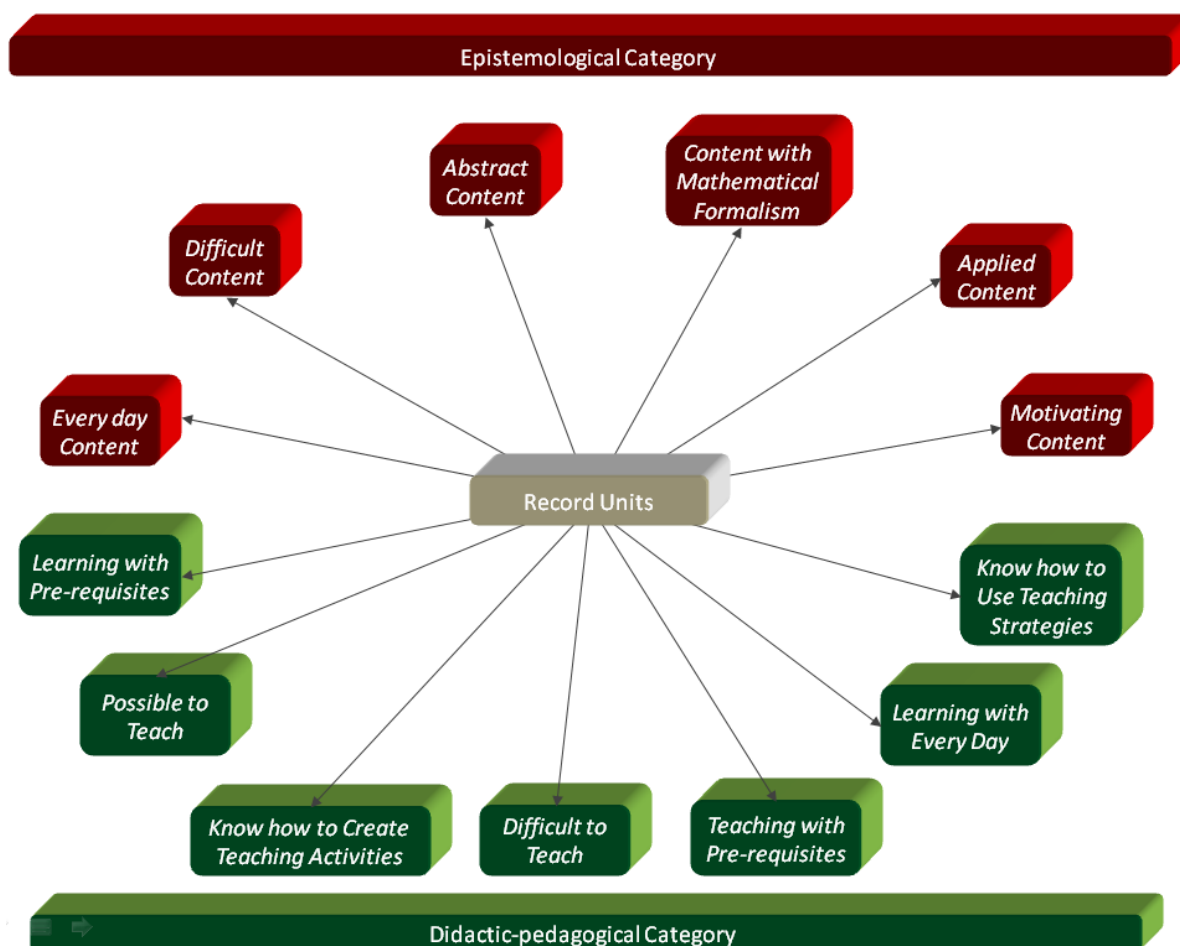
Saulo and Roberto participated in a mini-course on the subjects of “Particle Physics” in which were developed topics such as: Rutherford scattering, particle detection, laws of



conservation, fundamental interactions, the standard model of elementary particles and the connection between Cosmology and Particle Physics.

Both mini-courses, totaling 16 hours, had the objective of providing conceptual tools to prepare them to work with the proposed topics. After participating in the mini-courses, in a second stage of approximately 20 hours, the preservice teachers were set the task of analyzing the content studied in such a way as to adapt it and organize it into a teaching module, lasting 4 hours, which would be delivered to High School pupils in the city of São Carlos.

The interviews were subjected to a categorial analysis (Bardin, 1986). Based on the raw data, the record units were codified and categorized based on the set of data obtained, Figure 1. However, a perspective was also adopted by which the same recorded unit was classified in more than one category when this unit contained different meanings.



**Figure 1:** General scheme of record units organization

Didactic-Pedagogical Category:
It contains aspects that classify the possibility, relevance, difficulty, and the adequacy of strategies for teaching MCP in High School, as well as references to the learning of

these topics by the students.
Know how to Use Teaching Strategies: It contains excerpts from interviews of undergraduates wherein they refer to the use of strategies to teach topics of MCP.
<b>Epistemological Category</b>
It contains aspects that classify the content of MCP and its level of complexity.
Abstract Content: It encompasses excerpts of the respondents wherein they make mention of the MCP as a content with a lot of abstraction.

**Table 1:** Categories and some aspects definitions.

## Results

In this paper, due to space limitation, are just a few of the record units from the interviews with preservice teacher Roberto. The record units related to other aspects will appear with the symbol  $\Rightarrow$  linking them to them.

<b>Initial Interview</b>
<b>Epistemological Category</b>
Abstract Content: “It really is an obstacle, mainly for pupils who have not received very good teaching, who don’t have the foundations, who don’t have a good model of the atom, or perhaps someone who doe These are abstract things these concepts. For you to abstract even more is almost impossible (...)” $\Rightarrow$ Difficult to Teach; Learning with Pre-requisites
<b>Didactic-Pedagogical Category</b>
Know how to Use Teaching Strategies: “Then, what I would need to do was just adapt how I am going to teach what I learnt without mathematics, but it is possible to do this in a qualitative way, or with a smaller mathematical arsenal than the one that was learnt as an undergraduate. I think this is the way forward, but it has to be well thought through, otherwise it will be artificial. You’ll get by, but it’s not going to have the effect, and the pupil will not have learnt.” $\Rightarrow$ Content with Mathematical Formalism

**Table 2:** Some record units from the initial interview of Roberto.

For Roberto, in his initial interview, the concepts of MCP and its objects of study are abstract. In other words, the objects of MCP are absent from our sensorial perceptions and its concepts could be considered artificial and difficult to understand on the part of the students. The learning of these concepts depends on the knowledge of others that are themselves abstract such as, for example, energy and atomic models. On the other hand, MCP is applied in the most distinguished industries and in everyday life. Although he agrees with the need and the possibility of introducing MCP in the High School, the preservice teacher did not know how to teach it, especially without its original formalism, since he learnt MCP in a non-didactic manner and believes that he would teach it to High Scholl

pupils in the same way. He believes that he must give a lot of thought about a way to teach MCP removing the original mathematical formalism, since this could also make the students' learning more difficult. At the same time, he refers to the fact that the students do not have the mathematical tools to understand MCP. He thinks it is possible to work with themes of MCP with or without classical pre-requisites, although he hints at a certain preference for students who have already learnt classical concepts.

<b>Final Interview</b>
<b>Epistemological Category</b>
<b>Abstract Content:</b> “When a person does not understand, you have to have a strategy to attain that objective, to skirt around the mathematical formalism and skirt around the difficulties of the abstract content (...)” ⇒ Content with Mathematical Formalism; Know how to Use Teaching Strategies
<b>Didactic-Pedagogical Category</b>
<b>Know how to Use Teaching Strategies:</b> “If you manage to find an application that is a part of the pupil’s everyday life or a concept that is a part of the pupil’s everyday life, then that is valid (...)” ⇒ Learn with Everyday

**Table 3:** Some record units from the final interview.

In the final interview, Roberto indicates, once again, that the content of MCP is abstract, but this time he says that many of its objects of study – no longer all – are not present in everyday life. In addition, he says that there are also many objects of MCP close to everyday life and that they may be used as examples in it, although he does not provide any examples, even when pressed. On the other hand, he admits that some of the topics of MCP would find it hard to make sense to the pupils. He continues, nevertheless, to believe in the possibility of teaching MCP in High School and refers to what he did with Particle Physics to sustain this position. He underlines, this time, the retreat from mathematical formalism as the greatest difficulty in teaching MCP. Another obstacle in this endeavor is the lack of reference as to how to approach and create activities on this topic. With regard to a specific subject – Quantum Mechanics – he mentions, strangely that an experiment in front of the pupils would overcome the difficulty of providing an example on the subject! What is more, Roberto believes, in relation to other topics of MCP, that the abstraction of its concepts may be used as a motive. Thus, a question would be initially shaped in order for the students to give a response that would be obvious and incorrect. This would be immediately followed by a demonstration, a video or an experiment to show what in fact happens. According to him, it is necessary to have strategies to overcome the obstacles of the abstraction of the content and the retreat from formalism. Roberto is reticent about this retreat when he affirms that a large part of the content of MCP requires a rigor in mathematical formalism. His idea is striking about the need to find examples and games that create a dialogue with everyday life and facilitate the learning of the students. For the

teaching of MCP, he believes it is better if the students already know the classical concepts, although he does not stipulate that as a pre-requisite.

### **Discussion and Implications**

Based on the interviews it was possible to perceive the stability of his beliefs: the concepts of MCP are abstract; it is possible to teach topics of MCP in High School; it is preferable, but not necessary, that the pupils have a good understanding of classical concepts in order to work with concepts of MCP and teaching MCP is something difficult due to their being no solid references as to how to teach these concepts to High School level. It is possible to say that Roberto improved his beliefs concerning to knowing how to use teaching strategies and how create teaching activities even keeping at the end of the research many references about the difficult to teach MCP topics. Although Roberto, in both interviews consistently expressed the idea that it is necessary to have a strategy to withdraw mathematical from the teaching of topics of MCP, strangely he also gave a signal that this idea did not please him very much when he said that this procedure could make the students' learning more difficult; the retreat from mathematical formalism would be the greatest difficulty for teaching MCP in the High School and, finally, much of the content of MCP requires mathematical rigor.

It is important to underline the fact that both the teaching by transmission, and the belief of Roberto about teaching in the non-didactic manner with which he learnt MCP mainly in his undergraduate studies, are consequences of a process of cultural transmission that forges the system of beliefs of individuals. In this point, it is also important to mention that the research process, which encompassed the mini-course for the preservice teachers and, above all, the preparation of them to apply the topics of Particle Physics in the High School also influences the beliefs of Roberto by means of cultural transmission. However, as these experiences were still new, we know that his beliefs regarding MCP and the teaching of it to High School students would naturally not be as strong as those referring to Classical Physics and the teaching of it in the High School. Another important fact to stress is that his belief in traditional teaching added to his leadership in the group had some impact in the implementation of the mini-course conceived by them, which was considerably biased towards explanation rather than dialogue.

As we said, Roberto's belief that classical physics is more concrete was created during his years of study along their initial formation. Only through a great effort to explain how abstract classical physics concepts also can be is that such belief may be revised by future teachers and we can assume in this case that this phenomenon is general to the extent that this belief was built in common educational situations to many teachers. Moreover, although this conclusion be obvious, it is possible to deduce from the beliefs of this teacher the importance of working themes of Modern and Contemporary Physics in teachers training courses in terms of contents and in terms of pedagogy to provide teachers with means of plan and make decisions with greater confidence to implement themes of Modern and Contemporary Physics in High School, especially when the teacher realizes that he himself has no references on how to teach these topics to High School. Only a good work in the

initial teacher training courses can lay a solid foundation for consolidation of their beliefs about the inclusion of Modern and Contemporary Physics in High School, although this achievement is still a great challenge, since there is no consensus on how best to proceed in this sense. We aim that stimulate in prospective teachers the belief that it is preferable but not required, that students know well the classical concepts for working with concepts of Modern and Contemporary Physics helps to create a more flexible environment for the insertion of Modern and Contemporary Physics in classroom.

We hope to contribute to the research focusing on teacher beliefs in a context of curriculum innovation, so that among the main implications of this work, we highlight the available compilation of the beliefs of teachers about the inclusion of topics in Modern and Contemporary Physics in High School. This repertoire can be configured as a set of important information for teacher trainers who wish to compare these results with those of their own students and seek to influence positively on their beliefs, improving the initial training of its undergraduates in what concerns the insertion of Modern and Contemporary Physics in High School.

## References

- Bardin, L. (1986) *Análisis de contenido*. Madrid: Ediciones Akal.
- Bogdan, R.; Biklen, S. (1994) *Investigação Qualitativa em Educação. Uma Introdução à Teoria e aos Métodos*. Porto Editora (Coleção Ciências da Educação). Lisboa – Portugal.
- Brown, S., & McIntyre, D. (1978). Factors influencing teachers' responses to curricular innovations. *Research Intelligence*, 4(1), 19 – 23.
- Davis, K. S. (2003) "Change is Hard": What science teachers are telling us about reform and teacher learning of innovative practices, *Science Education*, 87, 3-30.
- Fullan, M., & Hargreaves, A. (1992). (Eds.). *Teacher development and educational change*. London: Falmer.
- McIntyre, D., & Brown, S. (1979). Science teachers' implementation of two intended innovations. *Scottish Educational Review*, 11(1), 42 – 57.
- Pajares, F. (1992). Teachers Beliefs and Educational Research: Cleaning Up a Messy Construct. *Review of Educational Research*, 62, 307-332.
- Pintó et al. (2001) Teachers transformations trends when implementing innovations. STTIS Report RW4 [online]. Retrieved March 15, 2003, from <http://www.blues.uab.es/~idmc42>
- Terhart, E. (1999) Developing a professional Culture. In M.Lang, J.Oison, H. Hansen, & W. Bunder (Eds.), *Changing schools/changing practices: Perspectives on educational reform and teacher professionalism* (pp. 27-39). Louvain: IPN and Garant.

## A Nanoscience Course for Upper Secondary Students

Anna-Leena Latvala<sup>1</sup>, Anssi Lindell<sup>1</sup>, Tom Nevanpää<sup>2</sup> and Jouni Viiri<sup>1</sup>

<sup>1</sup>Department of Teacher Education, University of Jyväskylä, Finland

<sup>2</sup>Teacher Training School Normaalikoulu, Jyväskylä, Finland

E-mail: [anna-leena.latvala@jyu.fi](mailto:anna-leena.latvala@jyu.fi), [anssi.lindell@jyu.fi](mailto:anssi.lindell@jyu.fi), [tom.nevanpaa@jyu.fi](mailto:tom.nevanpaa@jyu.fi), [jouni.viiri@jyu.fi](mailto:jouni.viiri@jyu.fi)

**Abstract:** The Organization for Economic Co-Operation and Development (OECD) suggests (Palmberg, Dernis & Miguet, 2009) that the number of jobs involving Nanoscience will increase by 2 million by the year 2015 and that the market value of Nanoscience products will be over 1000 billion dollars by 2015. In the ROSE study on student motivation (Lavonen, Byman, Juuti, Meisalo & Uitto, 2005), girls expressed interest in interdisciplinary items and boys in studying implementations of technology. Both areas are fundamental in Nanoscience education.

These opportunities in mind, we offered physics teacher students a task to design a Nanoscience- and technology-oriented course for upper secondary pupils. The course was constructed from Nanoscience expert lectures and experimental lessons. The major topics of the course were Forces and Interactions (via surface tension and surfactants), Tools and Instrumentation (via DNA electrophoresis and Atomic Force Microscopy) and Size-Dependent Properties (via thin films).

A co-operation between the physics teacher trainees and the scientists in the Nanoscience Center in Jyväskylä was a starting point for this course. The teacher trainees were instructed to design the learning units from ideas and discussions on Nanoscale topics, using educational reconstruction (Duit, Gropengiesser & Kattmann, 2005) to define meaningful and precise learning goals for each unit. In doing this, they received assistance from the scientists. This design procedure was developed for our pilot course in 2007. The new course took place in May 2010 in the Teacher training school of Jyväskylä. We present an overview of the course and one of the learning units as a case in educational reconstruction in physics teacher training as well as a school inquiry.

**Keywords:** Science Education, Nanoscience, Nanotechnology, Educational Reconstruction, Teacher Training

### 1. Introduction

Nanoscience can be thought of as the united effort of physics, chemistry and biology at the scale where all three sciences overlap: the nanoscale, or  $10^{-9}$  m. The so-called “Big Ideas of Nanoscience” (Stevens & Krajcik, 2009) are shared throughout the field and are often thought to form the foundations of Nanoscience Education. These ideas include e.g. development of new measuring techniques, size-dependent properties of matter and self-organizing of molecules.

In the next few years, Nanoscience is expected to present significant new work positions and to increase its market value worldwide (Palmberg et al., 2009). This presents a challenge to educate both the future designer and the consumer in Nanoscience. Fortunately, there is evidence that including Nanoscience as an interdisciplinary and technology-oriented topic in the classroom is beneficial for student motivation (Lavonen et al., 2005), especially if it is approached with experiments (Hutchinson et al., 2007).

Design as a research paradigm was chosen for this study to tie it in with an ongoing work of developing educational materials in Nanoscience. Design research is a cycle that includes assessment at every stage; assessment of the science content, the pupils' learning, the developed materials, and a final evaluation at the end of the process. The demanding part is that the development cycle must also result in theoretical understanding of learning that comes from the research (Design-Based Research Collective, 2003). For assessing the science content and designing the particular learning units for the Nanoscience course, Educational Reconstruction (e.g. Duit et al., 2005) was introduced to bring balance where there is inclination to focus on only the science content or the educational practices.

### 1.1. Research Questions

In the following chapters we clarify

- 1) to what extent the pupils learned to apply Nanoscience specific thinking to problems, and
- 2) to what extent the student teachers followed the instructed Educational Reconstruction approach in planning the course.

Both questions are looked shortly into from the general standpoint and more closely in the case of one learning unit, DNA Identification.

## 2. Methods

### 2.1. The Nanoscience Course and Participants

In late 2009 the development of a Nanoscience course for upper secondary pupils was started. It was entered into the city school system as an optional Physics course and registration was open to pupils from all schools in the city. The duration was 18 hours of class time (1/2 course credits in the Finnish system). The topics of the course addressed in experimental work were Forces and Interactions, Tools and Instrumentation and Size-Dependent Properties. The other "big ideas" were included in three expert lectures given by researchers from the Nanoscience Center of Jyväskylä. An outline of the course is shown in Table 1.

Table 1. Contents of the Nanoscience course in chronological order.

Lesson topic	Duration (h)	Contents
First meeting	2	Contents and timetable of course, pre-questionnaire on Nanoscience ideas
Magic Sand	3	Teflon-coated sand as a Nanotechnology product, surface tension and dominant forces
Lecture 1	1	Cellular biology in the Nanoscale
Lecture 2	1	Computational methods in Nanosciences
DNA Identification	3	How does DNA identification work, electrophoresis as a method in Nanoscience
Lecture 3	1	Self-Organized Molecular Electronics

Atomic Force Microscopy	3	Measuring interatomic forces, force microscopy as a method in Nanoscience
Soap Bubbles	3	Thin films and molecule size, a measuring technique for film thickness based on color
Final meeting	1	Feedback, post-questionnaire on Nanoscience ideas

In the beginning, the course had 20 participants from ages 16-19. By the end of the course there were 17 pupils left, 9 girls and 8 boys. 14 of those who completed the course had only taken two previous courses (36 h class time each) in Physics, and the remaining three had a varying number of courses between 5 and 10.

## 2.2. The Pre- and Post-Questionnaires


The pre-questionnaire (Table 2) was developed with the student teachers. There were questions targeted at each of the experiments in the course as well as some other areas of Nanoscience, to see if they are known to pupils. Answers of the pre-questionnaire were graded on a scale 0-1 on whether the answer showed insight and understanding of Nanoscience concepts. Full marks were given to any answer properly motivated by Nanoscience principles.

Table 1. The items in the Pre-Questionnaire on the first lesson.

Pre-Questionnaire Questions	
0	How many courses of Physics have you taken in upper secondary school?
1	Think of an example situation, where water is a) sticky, b) slippery.
2	The “Nano Skis” <sup>1</sup> glide and grip without waxing. Show how you think it works. Include a drawing.
3	What does the statement “Everything is sticky in nanoscale” mean? Give an example of the stickiness.
4	A thin film of oil floats on water. a) Why do we see colors in the film? b) How would you find out the thickness of the film?
5	A droplet of water sits on a glass plate. a) Explain why the water does not spread out evenly on the plate. b) Imagine a water drop the size of two molecules (grey orbs) that is attached to one molecule of a glass table (white ball). When the system is pulled apart evenly from both ends, where should the chain break on basis of part a)?

<sup>1</sup> A popular item in winter 2010. See e.g. <http://www.goodnewsfinland.com/archive/karhus-nano-ski-well-suited-for-wet-and-warm-skiing-conditions/>



	
6	a) What is DNA Identification? b) How is it connected to Nanoscience?
7	Give examples of Nanotechnology products.

The post-questionnaire (Table 3) was designed during the course. It included more specific questions on each of the experiments and a question on the lectures. It was graded on the same principle as the pre-questionnaire, but with stricter demand for evidence of understanding Nanoscience concepts.

Table 3. The items in the Post-Questionnaire on the last lesson.

<b>Post-Questionnaire Questions</b>	
1	Surface-modified sand. a) describe shortly how the moist-repelling coating in e.g. windows works. b) Come up with liquids that would wet the Magic Sand. How do they differ from water?
2	DNA investigation. a) How do the DNA of different people differ from each other? b) Give an example of how the difference can be observed.
3	Atomic force microscopy. a) Why is an accurate atomic force microscope built on a bottom plate separate from the rest of the building? b) Describe shortly how atomic force microscopes can be used to study endurance of a molecular bond.
4	A thin film of oil floats on water. a) Why do we see colors in the film? b) How would you find out the thickness of the film?
5	Lectures. a) Which research methods can you remember mentioned on the lectures? Name or idea is enough. b) What about applications?
6	Feedback. a) What was the most useful thing in the course? b) What would you hope was done different next time?

### 2.3. Student Teacher Assignment

The course design was done in co-operation between seven volunteer student teachers of Physics, a graduate student and the lecturer of Physics Education. All of the student teachers had at least 60 ECTS of Physics studies before entering the Physics Education courses.

The student teachers were instructed in Educational Reconstruction (ER) as a tool in designing the learning unit from science content new to them. The steps of content analysis were the following:

- a) scientific knowledge is analyzed and its core ideas are carefully extracted, and
- b) pedagogical content knowledge (PCK) is built from the core ideas with the support of educational research and the audience in mind.

Data from the student teachers' content analyses was collected from discussions during the planning stage, watching the lessons, the pupil instruction forms, and a teacher guide that they were required to turn in for Physics Education class.

### 3. Results

#### 3.1. Pupils' Learning of Nanoscience Concepts

The results of the pre-questionnaire were mostly very meager; the average score for the class was 44% of the maximum. The pupils had difficulties in explaining macro scale properties – such as stickiness or slipperiness – with reference to properties of the molecules. Instead, most offered states of matter or additives as the reason for different behaviors. The best understood phenomenon before the course was surface tension; the pupils were able to motivate their answer to a nanoscale question with their understanding of surface tension. The average grades for each pre-question are listed in Table 4.

Table 4. Average grades per question in Pre-Questionnaire

Question	Average grade (0-1)
1. Sticky or slippery water	0.21
2. Nano Skis	0.29
3. Sticky nanoscale	0.47
4. Oil film	0.26
5. Surface tension	0.79
6. DNA identification	0.41
7. Nano-products	0.68

After the course, the average score was 66% of the maximum. The pupils were able to use scientific terminology where appropriate. Their understanding of the underlying idea rather than memorizing tidbits was affirmed in answering questions that had not directly been discussed in class, e.g. 1b and 3a in Table 3. Especially the oil film question, which was the

same as in the pre-questionnaire, showed considerable improvement. The DNA identification question proved surprisingly difficult and it is discussed further in section 3.2. All of the grades are shown in Table 5.

Table 5. Average grades per question in Post-Questionnaire

Question	Average grade (0-1)
1. Surface-modified sand	0.76
2. DNA identification	0.35
3. Atomic force microscopy	0.66
4. Oil film	0.76
5. Lectures	0.74

Finally, the distribution of pupil scores in the pre- and post-questionnaires is shown in Figure 1. It clearly shows how the score distribution has shifted towards the higher end of the scale.

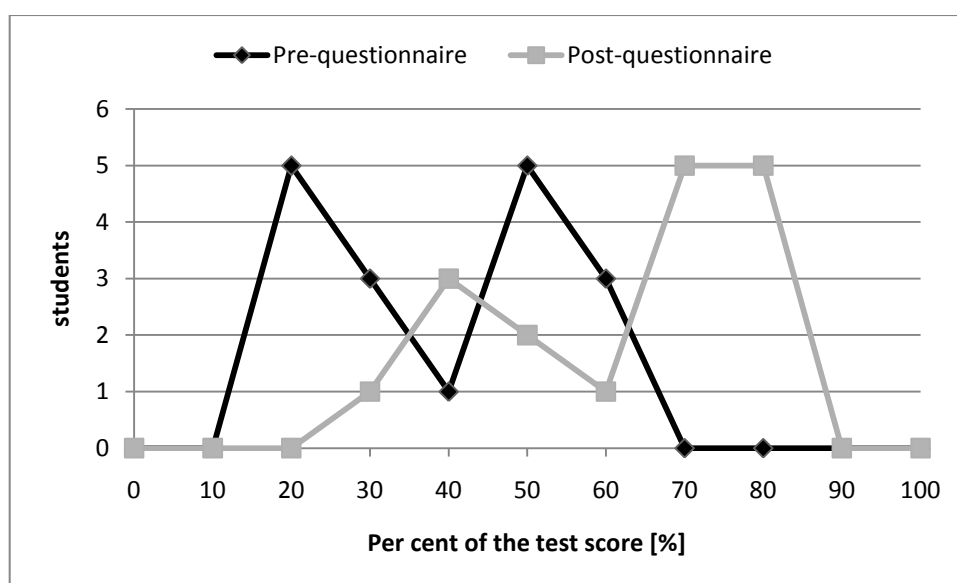


Figure 1. Distribution of pupil test scores in the Pre- and Post-questionnaires.

### 3.2. Case: Pupil Learning of DNA Identification

The Pre-questionnaire question was “What is DNA Identification? How is it connected to Nanoscience?” (average grade 0.41).

The answers reveal that even though pupils had a good understanding of what DNA is (demonstrated by use of words such as “base pairs”, “amino acids” and “protein formation” in their answers), their ideas of how DNA is identified were very vague. Only one pupil described “measuring the distances of certain sequences in the DNA”, evidently already understanding the procedure in general, whereas the rest offered generic explanations such as “identifying a person” (30% of answers). The pupils were also unclear on whether such

identification would identify differences between persons, identify two persons as relatives, or identify certain properties of a single person.

The post-questionnaire question was “How do the DNA of different people differ? Give an example of how the difference can be observed.” (average grade 0.35).

Interestingly, the post-questionnaire average for this question was worse than the pre-questionnaire average; taking into account that they were different questions and the post-questionnaire question required deeper understanding of the DNA identification process, it does not mean they knew less than when they came in. As in the other post-questionnaire items, the questions were more difficult. Here, the pupils had trouble explaining the procedure of observing the difference in required depth to gain points.

However, the pupils gave coherent answers indicating that the differences in DNA are related to the ordering of base pairs or differences in the lengths of DNA chain between the repeated sequences.

The DNA experimental work was interesting to the pupils and a couple nominated it as the most useful content of the course (see question 6 in Table 3).

### **3.3. Student Teachers’ Educational Reconstruction approach**

The student teachers together chose topics from Nanoscience-related products, news and publications. The preliminary topics were honed into lesson plans centered on one or two “big ideas” of Nanoscience.

Student teachers in general were receptive to the approach. Some of them had background in working at the Nanoscience Center (for Bachelors’ or Masters’ theses) and in discussions on how their projects were developing, they were excited to use their knowledge and to obtain new knowledge for themselves. Throughout the procedure they remained very motivated and serious about the Nano-course.

The use of information resources such as Internet guides and scientists at the Nanoscience center were soon automatic and did not require much outside guidance. Towards the end of the course, it became evident that the student teachers would have required help in using educational research knowledge in their work. The hints and sources for information given at the beginning of the project were not used and often forgotten throughout the project. The most pressing concern of the student teachers was getting their experiment “to work” and overcome practical issues, such as whether to use paper or plastic cups for a procedure.

### **3.4. Case: Designing a Learning Unit in DNA Identification**

Student teachers Sami and Tomi (pseudonyms) chose DNA Identification as a topic for their 3-hour learning unit. They began by studying the basics of the system using some internet resources and links suggested. The goal at this point was simply to plan an experimental work for upper secondary school pupils that would be a hands-on experience on manipulating DNA.

The internet resources used were e.g. the Learn.Genetics site (Genetic Science Learning Center, 2010) and the General Biology Program for Teachers site (University of Arizona, 2002) that both gave us ideas for using DNA investigations on a lesson. In addition, Sami and

Tomi used textbooks and searched for scientific knowledge online to build an understanding of the DNA Identification process.

As a second step, the student teachers worked in collaboration with a Nanoscientist on their lesson topic. Sami and Tomi had several discussions with Teemu Ihalainen, a nanobiology PhD, and were able to self make a DNA electrophoresis experiment in the lab at the Nanoscience Center in University of Jyväskylä. Gathered from the teacher package and the lesson outline, the ER process is outlined in Figure 2.

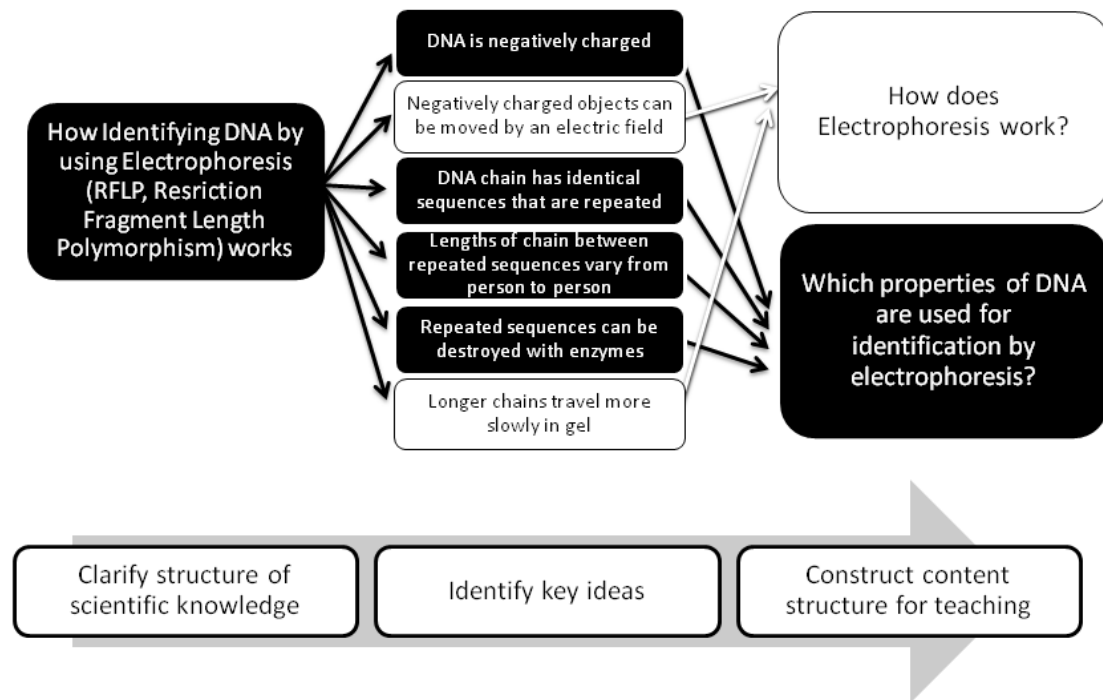


Figure 2. Application of Educational Reconstruction to knowledge in DNA Identification

The Pre-questionnaire findings led Sami and Tomi into putting more weight on the properties of DNA that are used for identification and the way that the results are interpreted in an experiment, rather than focusing on the principles of electrophoresis.

The changes and simplifications in the actual, scientific experimental procedure were due to practical reasons rather than pedagogical. The original goal had been to reproduce the electrophoretic method as faithfully as possible. Thus, choice between more expensive and hard-to-obtain substances, such as agar and agarose powders for the gel, was made on the basis of whether they noticed a difference in the experimental results. The decision to use food colorings rather than real DNA for the experiment was because of the difficulties and poisonous substances required in staining the DNA and viewing it under UV light.

However, when forced to abandon the original method, the student teachers did communicate the similarities and differences with the pupils. In their teacher guide, they wrote: “Food colorings can be used to visualize the DNA study by mixing several colorings into one sample. The electrophoresis separates the colorings from each other, just as the different [length] DNA chains would be separated.” The poor post-questionnaire results in

understanding the procedure of DNA electrophoresis suggest this comparison had deserved more attention in class.

#### **4. Discussion and Conclusion**

An overarching goal of the course was to be able to explain macro-world phenomena with micro-world concepts. Initially, this was very difficult for the pupils. Despite the use of different questionnaires at the beginning and the end, it was clear that pupils' understanding of Nanoscience concepts was greatly enhanced during the course. The feedback from pupils was mainly positive; they complained about difficulty of topics and timetable issues. The construction of the course from lectures and experiments proved to be a good choice, as seven pupils found the lectures to be the best part and ten preferred experiments – a very even result.

Student teachers in general followed the ER model up to extracting key ideas. In Sami and Tomi's work it was clear that they worked through the steps of acquiring scientific knowledge and broke it into key points for themselves; they tried out the experiments and discussed the content from the scientific point of view with staff members. This was essential in gaining expertise over the topic they had chosen and understanding the difficulties in the actual experimental work.

Unfortunately the student teachers were unable to use education research findings or specific knowledge of learning in doing the final reconstruction. This problem is likely connected to the biggest pupil complaint about the course: the explanations were too difficult for the pupils. With more attention to understanding how new content is learnt, the student teachers could have prepared different constructions of the content for the lesson. In the future, the student teachers with no background in educational sciences will be given more guidance in acquiring and using learning research in their task.

#### **References**

Duit, R., Gropengiesser, H., & Kattmann, U. (2005). Towards science education research that is relevant for improving practice: The model of educational reconstruction. In H. Fischer (Ed.), *Developing standards in research on science education*. Taylor & Francis, London.

Genetic Science Learning Center (2010, May 28) Electrophoresis Chamber. *Learn.Genetics*. Retrieved August 6, 2010, from <http://learn.genetics.utah.edu/content/labs/gel/gelchamber/>

Hutchinson, K., Shin, N., Stevens, S.Y., Yunker, M., Delgado, C., Giordano, N., & Bodner, G. (2007). *Exploration of Student Understanding and Motivation in Nanoscience*. Presented in the NCLT NSEE Symposium, NARST Conference, New Orleans, LA.

Lavonen, J., Byman, R., Juuti, K., Meisalo, V., & Uitto, A. (2005). *Pupil interest in physics: A survey in Finland*. *NorDiNa* 2, 72-85.

Palmberg, C., Dernis, H., & Miguet, C. (2009). *Nanotechnology: An overview based on indicators and statistics*. OECD, STI Working Paper 7.

Stevens, S., Sutherland, L., & Krajcik, J. (2009). *The big ideas of nanoscale science and engineering: A guidebook for secondary teachers*. Arlington, VA: NSTA Press.

The Design-Based Research Collective (2003). *Design-Based Research: An Emerging Paradigm for Educational Inquiry*. *Educational Researcher*, 32(1), 5-8.

The University of Arizona (2002). "General Biology Program for Teachers" –website. Retrieved August 6, 2010, from <http://biology.arizona.edu/scicomm/lessons2/Vuturo/vuturo/gel.htm>

# Teaching the Postulates of Quantum Mechanics in High School: A Conceptual Approach Based on the Use of a Virtual Mach-Zehnder Interferometer

Alexsandro Pereira de Pereira

Post-Graduate Program in Physics Education, Institute of Physics, Federal University of Rio Grande do Sul, Brazil. [alexandro.pereira@ufrgs.br](mailto:alexandro.pereira@ufrgs.br)

Cláudio José de Holanda Cavalcanti

Institute of Physics, Department of Physics, Federal University of Rio Grande do Sul, Brazil. [claudio.cavalcanti@ufrgs.br](mailto:claudio.cavalcanti@ufrgs.br)

Fernanda Ostermann

Institute of Physics, Department of Physics, Federal University of Rio Grande do Sul, Brazil. [fernanda.ostermann@ufrgs.br](mailto:fernanda.ostermann@ufrgs.br)

## Abstract

In this article, we propose a conceptual approach to discuss the postulates of quantum mechanics in high school level. The idea is to provide a ‘translation’ from quantum formalism to an accessible language for high school students in which the postulates are presented on a conceptual-phenomenological basis. Instead of using mathematical formalism, we shall illustrate some of the quantum postulates by focusing on a virtual simulation of the Mach-Zehnder interferometer.

## Introduction

For decades, studies on physics education have been concerned about how to teach in appropriate way quantum mechanics at high school. Most of this works are motivated by both conceptual and mathematical difficulties associated with quantum theory. As Hoekzema *et al* (2007) asserted, with many of conceptual difficulties being unavoidable, simplifying the mathematics becomes a top priority. Some authors have focused on the uncertainty principle (e.g. Johansson and Milstead 2008). Others have emphasized the de Broglie’s equation for deducing the energy level of a particle in a box, a finite square well, the hydrogen atom and a harmonic oscillator (e.g. Gianino 2008).

As a complement to these works, we present an instructional approach based on the canonical formulation of quantum theory in which six postulates play a central role. We shall propose a ‘translation’ from quantum formalism to an accessible language for high school students in which the postulates are presented on a conceptual-phenomenological basis. Instead of making statements about kets, bras, operators and others abstract mathematical entities, we shall describe the quantum postulates in terms of concepts associated with physical reality such as *state*, *eigenstates*, *eigenvalues* and *observables*. In addition, the notions of *superposition*, *collapse*, *probability* and *time evolution* are also introduced. Thus, mathematical formalism is avoided by using simulation software assistance.

The software here involved is a virtual simulation of the Mach-Zehnder interferometer, developed by our research group (Pereira *et al* 2009). The Virtual Mach-Zehnder Interferometer (VMZI) illustrates the interference of photons by simulating a light beam consisting of single photons. Real experiments with single photons have been performed since the beginning of the 1980s in advanced researches in Physics. Some didactical versions of these experiments have been developed for undergraduate level (Galvez *et al* 2005). Unfortunately, the proper technological resources required for these experiments are too much expensive for most schools, which makes almost impossible to demonstrate quantum interference in high school level. We believe that VMZI can fill this gap.



## The Mach-Zehnder interferometer

The Mach-Zehnder interferometer is a simple optical device created independently by Ludwig Zehnder (1854-1949) and by Ludwig Mach (1868-1951) around 1891-1892. It demonstrates the light interference by division of amplitudes (Zetie *et al* 2000). In the figure 1, a light beam is split into two components, A and B, by a beam splitter  $BS_1$ . Each one of these components is reflected by a mirror,  $M_1$  and  $M_2$ . A second beam splitter  $BS_2$  subdivides each of these components into two subcomponents and then recombines them before hitting the detectors  $D_1$  and  $D_2$ . For an incident angle of  $45^\circ$ , each reflection causes in the light wave a phase shift of  $\pi/2$ , which corresponds to a path length difference of  $\lambda/4$ , where  $\lambda$  is the wavelength of the light beam (Degiorgio 1980). In  $D_1$  direction, both subcomponents involved are reflected twice, which makes them to remain in phase, interfering constructively. In  $D_2$  direction, by the other hand, one of these subcomponents (path B) is reflected three times while the other one (path A) is reflected only once. The phase difference between them turns to  $\pi$ , which corresponds to a path difference of  $\lambda/2$  (destructive interference). As result of this experiment, a light beam is projected in  $D_1$  and nothing is detected in  $D_2$ .

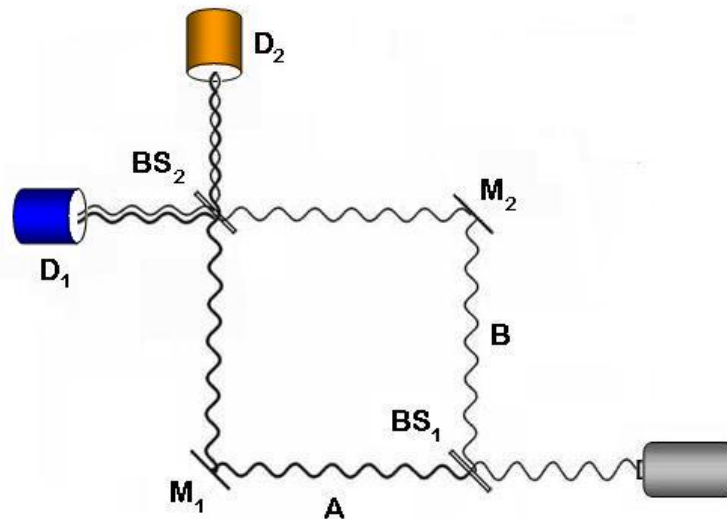


Figure 1. Scheme of Mach-Zehnder Interferometer.

According to some authors (Adams 1998, Pessoa Jr. 2003, Scarani 2006), the Mach-Zehnder interferometer can be a powerful tool for discussing fundamental concepts of quantum mechanics. In that case, we just have to consider a beam of light consisting of only a single photon. This consideration naturally leads to the path-choice problem (Scarani and Suarez 1998). It can help students to discover from the very beginning how quantum phenomena deviate from our classical everyday experience (Müller and Wiesner 2002). Although it has been largely used in nonlinear optical researches and technological applications (for example, see Kanseri *et al* 2008), the Mach-Zehnder interferometer is rarely mentioned in Physics textbooks, which makes it quite unfamiliar for most high school physics teachers.

## The postulates of quantum theory

In quantum mechanics the 'state' represents a set of complete information about the physical system. The 'observable' (e.g. momentum or energy), represents the measurable physical quantities of the system. All possible results of a measurement are defined as 'eigenvalues' of the observable being measured. The physical states associated with these eigenvalues are the 'eigenstates'. They correspond to mutually exclusive alternatives.

Incompatible observables such as position and momentum do not have a complete set of simultaneous ‘eigenstates’. This statement is known as the uncertainty principle.

According to Cohen-Tannoudji (1977), the postulates of quantum mechanics can be stated as the following:

**First Postulate:** At a fixed time  $t_0$ , the state of a physical system is defined by specifying a ket  $|\psi(t_0)\rangle$  belonging to the state space  $\mathcal{E}$ .

Since  $\mathcal{E}$  is a vector space, the first postulate implies a superposition principle: a linear combination of state vectors is a state vector.

**Second Postulate:** Every measurable physical quantity  $A$  is described by an operator  $\hat{A}$  acting in  $\mathcal{E}$ ; this operator is an observable.

**Third Postulate:** The only possible result of the measurement of a physical quantity  $A$  is one of the eigenvalues of the corresponding observable  $\hat{A}$ .

**Fourth Postulate:** When the physical quantity  $A$  is measured on a system in the *normalized* state  $|\psi\rangle$ , the probability  $P(a_n)$  of obtaining the non-degenerate eigenvalue  $a_n$  of the corresponding observable  $\hat{A}$  is:

$$P(a_n) = |\langle u_n | \psi \rangle|^2$$

where  $|u_n\rangle$  is the normalized eigenvector of  $\hat{A}$  associated with the eigenvalue  $a_n$ .

**Fifth Postulate:** If the measurement of the physical quantity  $A$  on the system in the state  $|\psi\rangle$  gives the result  $a_n$ , the state of the system immediately after the measurement is the normalized projection of  $|\psi\rangle$  onto the eigensubspace associated with  $a_n$ .

**Sixth Postulate:** The time evolution of the state vector  $|\psi(t)\rangle$  is governed by the Schrödinger equation:

$$i\hbar \frac{d}{dt} |\psi(t)\rangle = H(t) |\psi(t)\rangle$$

where  $H(t)$  is the observable associated with the total energy of the system.

Many of these postulates establish a link between physical reality and mathematical formalism, as it is shown in figure 2.

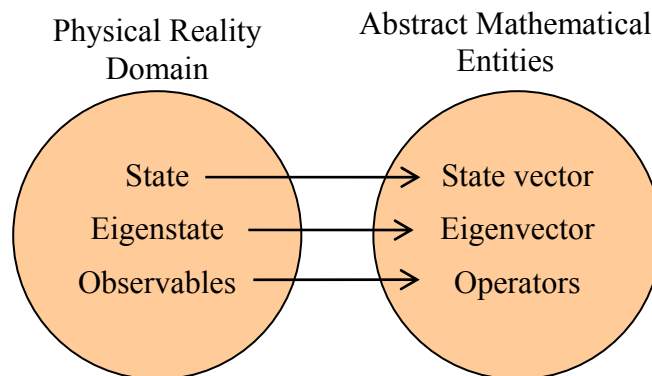


Figure 2. Theoretical ‘link’ between physical reality and mathematical formalism.

In order to avoid mathematical formalism, we propose the replacement of these quantum postulates by six rules concerning only the domain of physical reality. These rules are based on a conceptual description of the measurement process as asserted by Dirac (1947) and by Sakurai (1994). The conceptual-phenomenological version of the quantum postulates is formulated as the following.

**Rule 1:** Before a measurement, a system is assumed to be in a superposition of states (a linear combination of its eigenstates).

**Rule 2:** A measurement usually changes the state of the observable being measured, unless the state is already in one of its eigenstates.

**Rule 3:** The result of a measurement yields one of the eigenstates of the observable being measured. The measurement process selects one of its eigenstates and rejects all the others.

**Rule 4:** The laws of quantum mechanics do not predict the result of a measurement but only the probability of the system for jumping in one of its eigenstates.

**Rule 5:** Repeated measurements of the same observable in succession yield the same result.

**Rule 6:** The state of a physical system changes with time.

### An illustration with VMZI

Many important statements of these six rules can be conceptually shown on the VMZI. Figure 3 shows the layout of the VMZI operating in a simple configuration. Single photons are shot into the interferometer, one at a time. Two detectors, the green one and the red one, are placed in each path of the interferometer in order to perform a measurement. In this case, the photons' behavior must be described in terms of its *translational state* (Dirac 1947).

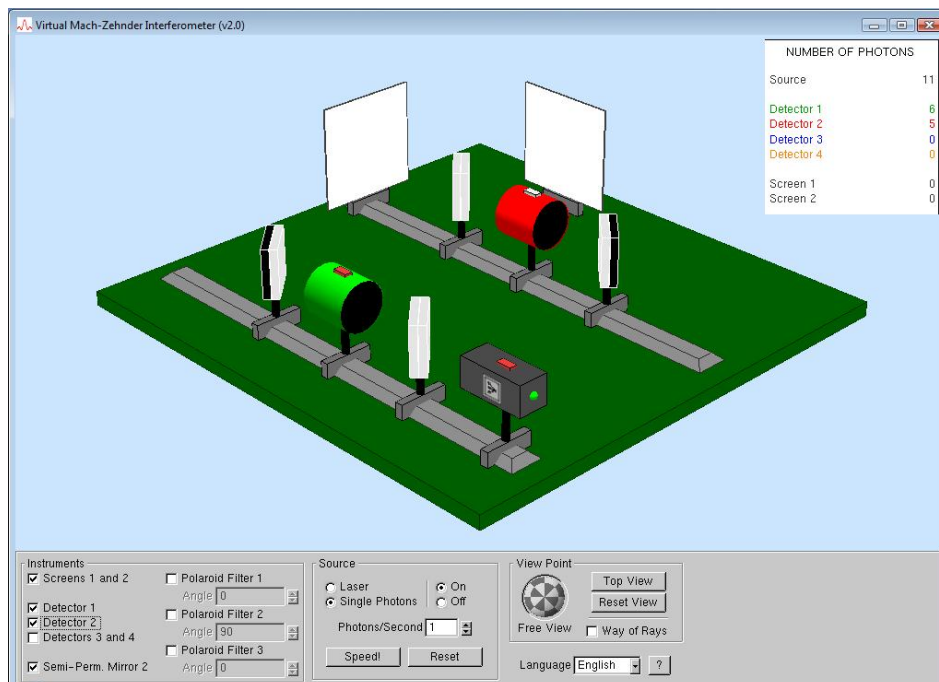


Figure 3. Photon detection in the green detector (a red light flashes on top of this detector).

In this case, the photon is described as going partly into each of the two components into which the incident beam is split. In other words, the photon can be thought as a combination of reflected and transmitted eigenstates, which means that the translational state of the photon is given by the superposition of the two translational states associated with the two components. By determining the energy in one of the two components, we obtain either the whole photon or nothing at all. It means that after hitting the detectors, the detection forces the photon to jump into one of its eigenstates (path 1 or path 2). Thus, the photon changes suddenly from being partly in one component and partly in the other to being entirely in one of the two components. This collapse is the result of the disturbance in the translational state of the photon caused by the measurement process. Before the measurement we are unable to determine which path the photon will take. We only can determine the probability of finding the photon in one particular path.

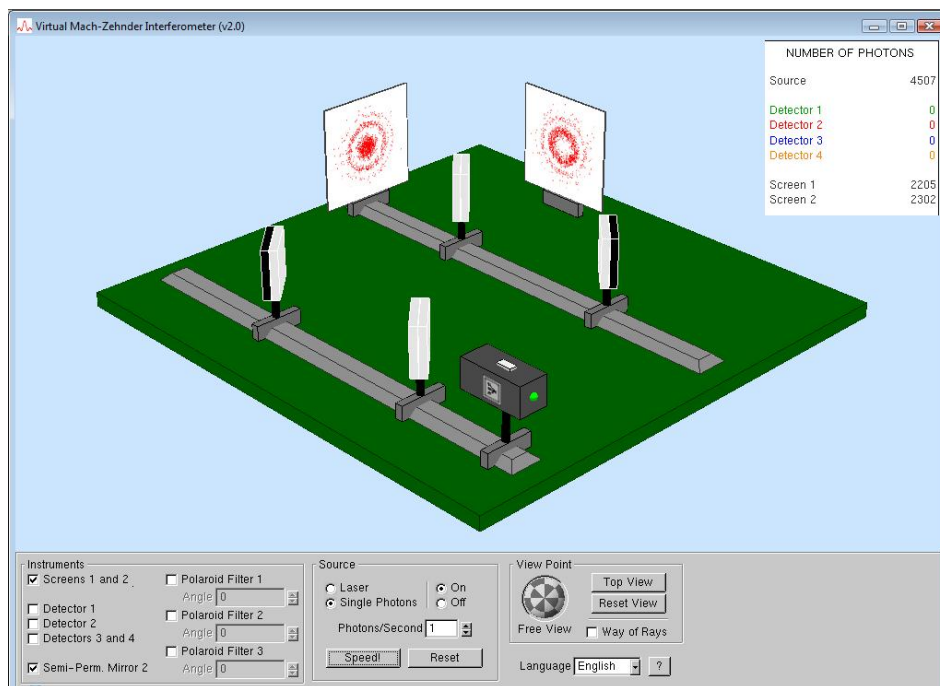


Figure 4. Interference of photons

## Conclusion

In this article, an instructional approach for the teaching of quantum mechanics in high school level is proposed. This approach is based on the canonical formulation of quantum mechanics in which six postulates play a central role. We formulated a conceptual version of these postulates in which mathematical formalism is avoided. Some of these postulates were discussed by using a Virtual Mach-Zehnder Interferometer (VMZI).

As an illustration of simulation software assistance, we presented only one simple experiment with the VMZI in which a detection of a single photon is described in terms of the postulates of quantum theory. Nevertheless, the use of VMZI proposed here also involves discussions on polarization and interference of photons (see figure 4 and figure 5). This instructional approach is being tested in a secondary school with a group of high school students. The results of this didactical intervention may be available by November 2010.

A new version of VMZI is being developed by our research group. The idea is to include non demolition detector to discuss issues such as the fifth postulate and the measurement problem. In this new version, A KDP crystal may be available for replacing the first beam splitter in order to demonstrate interference of two entangled photons. The version of VMZI used here is available at the following Web address: [www.if.ufrgs.br/~fernanda](http://www.if.ufrgs.br/~fernanda)

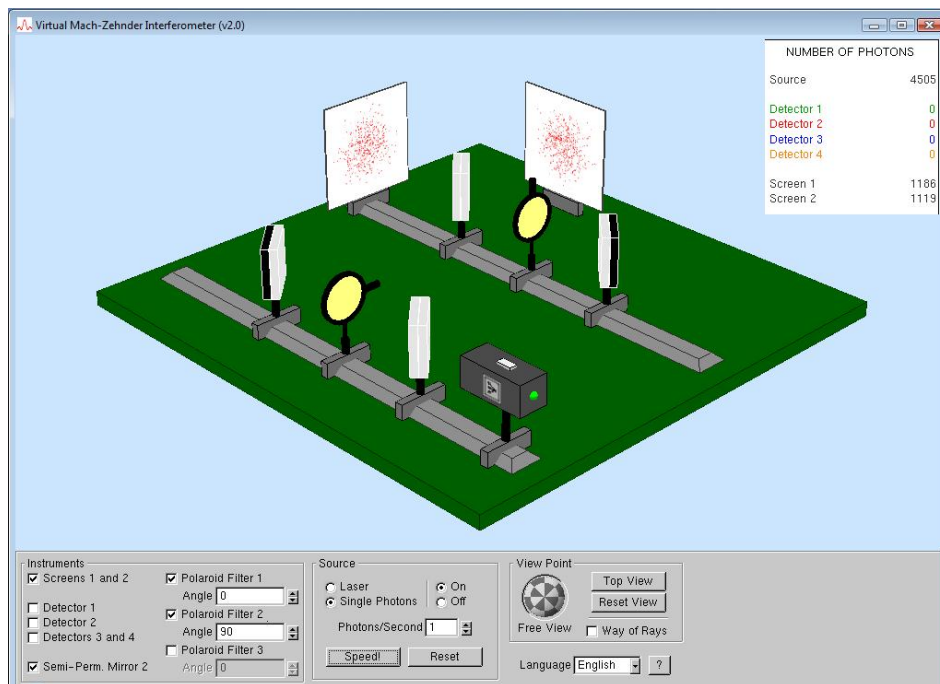


Figure 5. Polarization of the photons.

## Acknowledgment

The third author of this article thanks the Brazilian National Research Committee (CNPq) for finance support.

## References

- Adams S 1998 Quantum bombing reality *Phys. Educ.* **33** 378-85
- Cohen-Tannoudji C 1997 *Quantum Mechanics* (New York: John Wiley)
- Degiorgio V 1980 Phase shift between the transmitted and the reflected optical fields of a semireflecting lossless mirror is  $\pi/2$  *Am. J. Phys.* **48** 137-42
- Dirac P A M 1947 *The principles of quantum mechanics* (Oxford: Clarendon Press)
- Galvez E J, Holbrow C H, Pysher M. J, Martin J W, Courtemanche N, Heilig L and Spencer J 2005 *Am. J. Phys.* **73** 127-40
- Gianino C 2008 Energy levels and the de Broglie relationship for high school students *Phys. Educ.* **43** 429-432
- Hoekzema D, van den Berg E, Schooten G and van Dijk L 2008 The particle/wave-in-a-box model in Dutch secondary schools *Phys. Educ.* **42** 391-98
- Johansson E K and Milstead D 2008 Uncertainty in the classroom – teaching quantum physics *Phys. Educ.* **43** 173-79
- Kanseri B, Bish t N S, Kandpalb H C and Rath S 2008 Observation of the Fresnel and Arago laws using the Mach-Zehnder interferometer *Am. J. Phys.* **76** 39-42
- Müller R and Wiesner H 2002 Teaching quantum mechanics on an introductory level *Am. J. Phys.* **70** 200-9
- Pereira A, Ostermann F and Cavalcanti C 2009 On the use of a virtual Mach-Zehnder interferometer in the teaching of quantum mechanics *Phys. Educ.* **44** 281-91
- Pessoa Jr. 2003 *O Conceitos de Física Quântica* (São Paulo: Livraria da Física)
- Sakurai J J 1994 *Modern quantum mechanics* (Reading: Addison-Wesley)
- Scarani V 2006 *Quantum Physics a First encounter: Interference, Entanglement, and Reality* (New York: Oxford University Press)
- Scarani V and Suarez A 1998 Introducing quantum mechanics: One-particle interferences *Am. J. Phys.* **66** 718-21
- Zetie K P, Adams S F and Tocknell R M 2000 How does a Mach-Zehnder interferometer work? *Phys. Educ.* **35** 46-8

## Intuitive approach to defects in liquid crystals

T. Kranjc

University of Ljubljana, Faculty of Education, Slovenia

e-mail: [tomaz.kranjc@pef.uni-lj.si](mailto:tomaz.kranjc@pef.uni-lj.si)

### Abstract

Liquid crystals (LCs) can serve as an excellent instruction aid for various topics in physics, in the first place to help visualizing microscopic configurations of the constituent elements (rod-like or disc-like molecules), or for a clear understanding of several optical phenomena, like birefringence. They provide a natural way to understand symmetries and ordering (positional and orientational) underlying different states of matter, and the corresponding introduction of order parameters suitable for quantifying the degree of order.

In particular, pictures of layers of liquid crystals put between crossed polarizers in a polarization microscope reveal a variety of textures. This conveys information about the inner structure of the LC phases as described by the director  $\mathbf{n}$ . From polarization microscope pictures, the director field can be visualized and the arrangement of the molecules may be inferred. In nematic liquid crystals pictures show typical patterns from which director singularities can be deduced in a clear way.

In LCs, defects are of fundamental importance both in understanding the microscopic structure of LCs as well as because of their technological significance. For this reason, they might deserve to get some mention in school. In this contribution, we present the classroom introductory work on defects in nematic liquid crystals for the fourth year students of the Faculty of Education having combined majors in science covering the following topics: understanding polarizing microscope pictures, tracing local optical axes, deciphering molecular arrangements and visualizing the director field, and identification of director singularities. Also, students are encouraged to try to construct the director field for some types of restricted geometries which induce formation of defects (like a wedge disclination in a cylinder). Characteristic features (leading to the concept of strength) of the most common topological defects that occur in nematic LCs are described and energy considerations included.

### 1. Introduction

In the last decades we have witnessed a decreasing interest in sciences and in particular in physics, at all levels of education, resulting in a declining number of physics majors at the university level. The traditional approach of instruction has proven to be less and less effective: the usual method of teaching a body of knowledge (presenting basic principles illustrated by performing demonstration experiments, followed by application of these principles to solving problems) is not attractive, does not open ways to students' creativity and lacks a motivating force (Etkina and Van Heuvelen 2001; Karelina and Etkina 2007; Viennot 2006, 2010a, 2010b).

To be more specific, there are several serious flaws in this scheme of education:

- compartmentalization of knowledge and absence of connections between the "compartments";
- a lack of exercise resulting in the inability of applying principles of physics to problem solving;
- gap between students' knowledge and their capacity to use it;
- the fear of making mistakes and therefore to tackling more complex problems;
- a lack of repetition resulting in poor and inaccurate memorization;
- a lack of appeal and fun in doing physics.



The usually one-way flow of information makes the absorption of new facts *linear*, in the sense that *horizontal* connections are not established between various topics, and structural similarities are not presented and emphasized. This leads to a “compartmentalization” of the body of knowledge, while the main emphasis should be put on structural similarities and the underlying unity (Kranjc 2006).

Although “creativity” is one of the basic principles that the teaching process is supposed to be built upon, the instruction is often organized in a way leading to a division between “theory” and “problem-solving”, precluding creativity. On one hand, students learn the “theory” (“the body of knowledge”); on the other hand they are trained in problem-solving, often in a *procedural* way: get the problem’s input data, find the appropriate formula(s), calculate the solution(s). In problem-solving, students are made to live in the category of formulas. If there is no formula at hand, they feel lost.

A further observation is that students are not accustomed to deal with more advanced and complex problems requiring multi-step processes in seeking a solution. Most often, tests include one- or two-step problems which do not require searching for the right way from the input data to the final solution. In more complex problems, students may understand and perform all single steps separately but, without guidance, they are not able to find a way from a step to the next one. Even worse: they do not even try for fear of making a wrong step. It is very important that they realize that any research necessarily includes errors, wrong steps and mistakes. These, in turn, require corrections. This is the very essence of research work.

It often turns out that students, although possessing good knowledge of a wide range of facts, are unable to make an efficient use of them (Kranjc et al. 2009). *The gap between students’ knowledge and their ability to use it is a major failure of instruction.* This is an important problem that deserves a great deal of attention and systematic efforts should be made to overcome it.

One of the answers of how to improve the efficiency of instruction is *inquiry-based* teaching and learning. Within the inquiry-based instruction students have to make use of their already acquired knowledge, are led to discover new facts and to refine their understanding. It is to be emphasized that inquiry-based teaching-learning is by no means limited to experimental work, but is equally well suited and necessary in theoretical work.

An important thing to know is that there is no way to knowledge without work and effort. In order for students to be ready to make the effort of working through a physics topic, it has to be interesting and attractive so that they *enjoy* working on it. The standard procedure of the physics instruction, at all levels, has to be supplemented (rather than replaced) by interesting topics and new approaches which are able to intrigue and motivate students. They should be stimulated to do *research*, at an appropriate level. At the school level, this means, among other things, finding explanations in terms of the previously acquired fundamental knowledge.

A critical parameter of how to organize the instruction process seems to be *time*. At whatever level of education, the syllabus determines what students have to learn within a course. Teachers feel obligated to cover the syllabus, usually at the expense of experiments, discussion, and understanding. We believe that inquiry-based teaching is not time consuming but rather time saving in the long run. There is no point in explaining a lot of things that students do not really understand; we prefer offering fewer things in a way that conveys understanding and gives a student the ability to use them.

In this paper we propose the topic of topological defects in liquid crystals (LCs) to be used as a prototype of how to approach and deal with a physical problem (essentially, an *inquiry-based procedure*). It was offered to students of the condensed matter physics course which is a senior level course for students who have combined majors in physics-chemistry

and physics-technology at the Faculty of Education of the University of Ljubljana. The condensed matter course includes a chapter on LCs in which the main notions of LCs are introduced. Topological defects are not a part of the syllabus.

In the subsequent sections, we present a program of research, important problems encountered in the inquiry, and some conclusions.

## 2. Topological defects: Inquiry

There were two main reasons for the workshop: to satisfy students' interest and to use the opportunity to perform a research-like teaching-learning process.

The goals of the workshop were to:

- introduce students to “research”-like projects,
- make students rediscover and *use* the already acquired knowledge,
- get students used to team work (discussions, sharing of experiences, ...),
- prepare students for further study (e.g., enabling them to read more advanced texts),
- build perseverance and persistence at work,
- have students feel satisfaction.

Students were expected to learn to

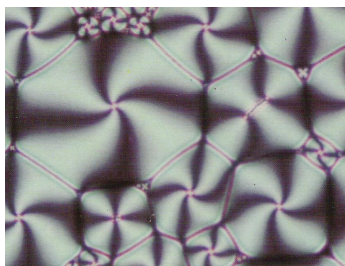
- link various pieces of knowledge hidden in “separate closed boxes”,
- perform multiple-step processes (requiring more time, more perseverance and more effort than those that they are used to),
- make hypotheses, test them, invalidate them, make corrections, ...,
- not be afraid of making wrong steps and errors.

The only prerequisites for the workshop were time and engagement. No prior knowledge about defects in LCs was required; students already had all the information necessary to understand the material (Pavlin et al. 2011).

There was a dilemma: Is the material not too difficult? The critical parameter was time, rather than the difficulty of the subject. A “research” work should not be hampered by a lack of time (as is often the case in class), rushed work and the consequent inefficiency. At every step of the investigation, there should be enough time to discuss it and to check it thoroughly.

## 3. The program of the inquiry

The idea of investigating defects in LCs came from the cover picture of a book on LCs shown in Fig. 1 (Kumar 1995) which drew the attention of students; similar pictures often appear as a characteristic feature of LCs.



**Fig. 1.** The cover picture of a book on LCs (Kumar 1995) showing typical patterns produced by defects and seen under a polarizing microscope.



The program consisted of the following steps (each step had yet to be discovered):

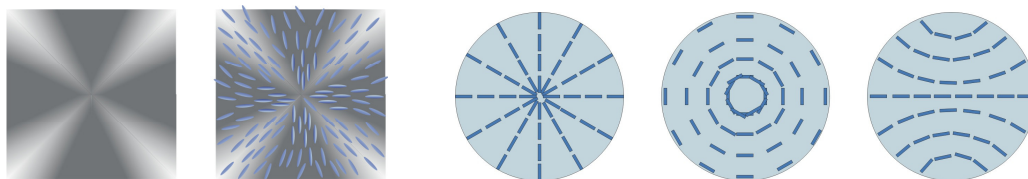
- What circumstances are needed for the patterns to be seen?
- Birefringent material between crossed polarizers: how does a light beam pass through?
- Homogeneous LC cell on a rotating stage of a polarizing microscope.
- Guessing the director field from the pattern seen by the polarizing microscope. Singularity of the order parameter.
- Guessing characterizing features of the defects. Symmetry.
- Frank strength index of a defect.
- Sketching the director field of a wedge disclination; tangent lines.
- Interdisciplinarity: calculating the tangent lines.
- Wedge and twist disclinations.
- Distortion energy of a wedge disclination.
- Topology considerations.

We give here a short overview of the workshop.

The first step of the investigation was the description of how patterns, such as the one in Fig. 1, appear. They may be seen when a nematic LC layer is put between crossed polarizers and observed by a polarizing microscope.

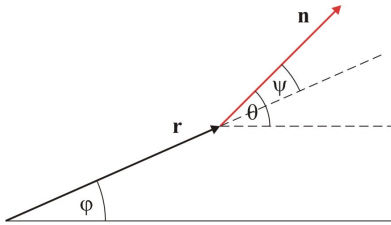
This was followed by placing a homogeneous nematic cell between crossed polarizers and rotating it around an axis perpendicular to the plane of the cell. The students were already familiar with birefringence, so it did not take a lot of time to discover the phenomenon of *extinction*: whenever the polarization of light is parallel or perpendicular to the polarizer, no light passes through the cell (Kranjc and Pirs 2008). Then it was easy to see that, as the cell is rotated a full turn on the microscopic stage, it goes four times through extinction.

The patterns in Fig. 1 (“schlieren textures”) show four (and sometimes two) dark brushes (de Gennes and Prost 1993; Vertogen and de Jeu 1988). What is the director field ( $\mathbf{n}$ ) producing the patterns? Obviously, the dark regions are determined by  $\mathbf{n}$  lying either parallel or perpendicular to the polarizer or analyzer axes. At the points of contacts of the brushes, there are singularities of the director field, called (wedge) disclinations. Students found it easy to guess the correct director field (Fig. 2).



**Fig. 2.** Possible director field ( $\mathbf{n}$ ) configurations producing four brushes. Note the singularities of the director field.

The next step was to guess the characterizing features of the defects. Using symmetry considerations, students had to look for the solution  $\theta = \theta(\varphi)$  (or, equivalently,  $\psi = \psi(\varphi)$ ) where  $\varphi$  is the polar angle measured from some chosen polar axis in the plane and  $\theta$  gives the orientation of the director ( $\mathbf{n}$ ) at a given point (Landau and Lifschitz 1989) (Fig. 3).



**Fig. 3.** Angles  $\varphi$ ,  $\theta$  and  $\psi$ .

It is an elementary consequence of symmetry that

$$\theta(\varphi + 2\pi) = \theta(\varphi) + 2\pi k \quad (1)$$

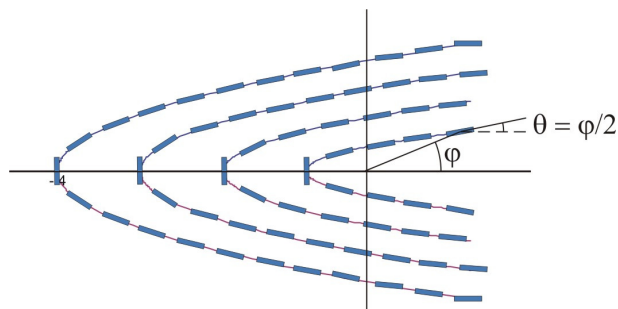
where  $k$  is an integer or a half-integer ( $\mathbf{n}$  and  $-\mathbf{n}$  are indistinguishable) called the Frank strength index of a defect. Solutions with  $k \neq 0$  include configurations of  $\mathbf{n}$  that may not be found on an intuitive basis.

It turned out that students understood the symmetry argument leading to (1), but failed to grasp the significance of the result (1). When asked to derive from (1) a similar relation for  $\psi$  ( $\psi(\varphi + 2\pi) = \psi(\varphi) + ?$ ), they did not, at first, even understand the point of the question.

Further, when asked to find the solution  $\theta = \theta(\varphi)$  of the eq. (1), they did not realize that (1) in fact represents an equation for  $\theta = \theta(\varphi)$ . Only after having seen the solution  $\theta(\varphi) = k\varphi + \theta_0$ , they were able to appreciate the whole symmetry-based argument and to understand the significance of the solution.

Also, sketching the molecular configuration for various strengths  $k = 1, -1, 1/2$  and  $-1/2$  was difficult and students had to clarify, time and again, in the course of using it, the meaning of the relation  $\theta(\varphi) = k\varphi + \theta_0$  (Fig. 4). This clearly showed how important practical use and verification of any knowledge are—it is only through practical use that real understanding can be achieved.

The next step was an “interdisciplinary jump”: using the appropriate knowledge from mathematics, it was necessary to calculate the tangent lines in order to visualize the director field. In other words, it was necessary to determine the curve  $y = y(x)$  such that, at any point, it indicated the orientation of the molecules. The tangent is given by  $dy/dx = \tan \theta$  from which the curve  $y = y(x)$  can be deduced. It turned out again that students find it very difficult to use their knowledge from one specific “box” in different contexts (here, application of mathematics to a physics problem).



**Fig. 4.** A sketch of a wedge disclination of strength  $k = 1/2$ .

In addition to wedge disclinations, twist disclinations were also considered along the same lines. The director field was discovered and tangent lines sketched to visualize it.

A rough estimate of the energy (per unit length of line) was made in one constant approximation (de Gennes and Prost 1993). At the end, the concept of *topological* defects was introduced.

#### 4. Conclusion

We can draw several conclusions concerning the execution, the results and possible benefits of the workshop. Here are some findings:

- Students have little practice in solving problems independently (without close guidance) and little self-confidence.
- There is a big gap between having factual knowledge and having the ability to use it.
- Students are unable to link pieces of knowledge acquired in different contexts.
- The “process” of using knowledge is the best opportunity to repeat, refine and better understand it. Knowledge should be “solidified”: pieces of knowledge should be repeated in order that the students get used to them. “Knowledge = getting used to...”.
- Students are not accustomed to more advanced problems requiring a multi-step processes in seeking a solution.
- Students are afraid of making errors. They have yet to learn that trial and error is not a “deficient” method of using one’s knowledge, but rather a good method not only to arrive at a solution, but also to clarify the concepts and the right meaning of basic notions and physics laws.
- Solving more complex problems *takes time, effort and perseverance*.
- Many “difficult” problems are regarded as such by students because it takes time, effort and perseverance, rather than a lot of knowledge, to arrive to the solution.

They found the main benefit of the workshop “the completely new way of addressing a problem” and a “surprising capacity of their (‘hidden’) knowledge in solving a problem”. Consequently, they found the “inquiry-based” learning much more efficient than the traditional instruction which covers new facts and illustrating examples with minimal student participation.

Inquiry-based instruction acts as a stimulus and has some beneficial secondary effects that are not to be underestimated: a successfully performed inquiry not only increases knowledge and makes it more reliable but also makes students feel self-confident, have fun doing physics, and increase their ambitions in the field.

#### References

- Etkina, E. and Van Heuvelen, A., 2001. *Investigative Science Learning Environment: Using the processes of science and cognitive strategies to learn physics*, Proceedings of the 2001 Physics Education Research Conference. Rochester, NY, PERC publishing, 17-21.
- de Gennes, P. G. and Prost, J. 1993. *The Physics of Liquid Crystals*, Clarendon Press, Oxford.
- Karelina, A. and Etkina, E., 2007. Acting like a physicist: Student approach study to experimental design, *Phys. Rev. ST Physics Ed. Research* 3, 020106.
- Kranjc, T. 2006. Understanding basic physical concepts – which?, in van den Berg, E., Ellermeijer, T. and Slooten, O. (eds.): *Modelling in Physics and Physics Education*, Proceedings GIREP Conference 2006, University of Amsterdam, 654.
- Kranjc, T. and Pirš, J., 2008. Electrically controlled colour filters. In: JURDANA-ŠEPIĆ, Rajka (ed.). *Frontiers of physics education : selected contributions*. Rijeka: Zlatni rez, 2008, str. 228-233.
- Kranjc, T. et al., 2009. An artificial plasma welding light source, in: *Instructional Aids, GIREP-EPEC & PHEC 2009 International Conference*, University of Leicester, Leicester.
- Kumar, S. (ed.) 1995. *Liquid Crystals in the Nineties and Beyond*, World Scientific, Singapore.
- Landau, L. D. and Lifschitz, E. M. 1989. *Elastizitätstheorie*, Akademie-Verlag, Berlin, p. 175.

- Pavlin, J., Susman, K., Zihler, S., Vaupotič, N. and Čepič, M., 2011. How to teach liquid crystals, *Mol. cryst. liq. cryst. (Phila. Pa.: 2003)*, **547**, 255-261.
- Vertogen, G. and de Jeu, W. H. 1988. *Thermotropic Liquid Crystals, Fundamentals*, Springer-Verlag, Berlin.
- Viennot, L. 2006. Teaching rituals and students' intellectual satisfaction, *Phys. Educ.*, **41**, 400-408.
- Viennot, L. 2010a. Physics by inquiry: beyond rituals and echo-explanations, Menaube & G. Santoro (eds.) *New Trends in Science and Technology Education*, CLUEB, Bologna.
- Viennot, L. 2010b. Physics education research and inquiry-based teaching: a question of didactical consistency, in K. Kortland (ed.): *Designing Theory-Based Teaching-Learning Sequences for Science Education*. Utrecht:Cdß press, 39-56.

## Contemporary physics: challenges and bets for teaching and communicating science.

Eugenio Bertozzi, Elisa Ercolessi, Olivia Levrini  
Department of Physics, University of Bologna, Italy  
Corresponding author's e-mail: eugenio.bertozzi2@unibo.it

### 1. Introduction

The paper aims at arguing that many problems Physics Education Research (PER) has to face for teaching and communicating basic ideas of contemporary physics (Quantum Field Theory and elementary particles) cannot be simply ascribed to difficulties in translating a sophisticated formal language in linguistic forms at reach of secondary school students. Many of them, indeed, regard deep conceptual nodes that research on the theory's foundations has not yet clarified.

Contemporary Physics (CP) is without doubt an advanced and specialized topic that has so far received little attention within the field of PER.

Nevertheless, a growing interest about the topic can be observed in recent years and a certain number of studies has been producing teaching proposals for introducing elements of CP at the secondary school level or within introductory physics courses at the university level.

The main motivations of the interest stem from the new requirements of secondary school physics curricula and from the acknowledgement of some problematic issues in teaching quantum mechanics that enforce the search for new teaching paths on quantum physics (Giliberti et al., 2002). Further motivations derive from the need of tuning school and extra-school activities: Particle physics and the standard model, for example, are object of popular science books and of important exhibitions that are having a greater and greater success of public.

### 2. The fundamental concept of quantum field and the canonical procedure

Within CP the concept of quantum field plays a fundamental role as it becomes immediately evident when particles phenomena occurring in the relativistic framework are taken into account:

*“In relativistic quantum mechanics the total energy of the system is conserved (including also the rest energy of particles) so the particles number could be not conserved.*

*As a consequence, every relativistic theory for particles must be a theory of systems with infinite degrees of freedom. In other words the theory gains the feature of a field theory”<sup>1</sup>*  
(Berestetskij et al, 1978)

In the specialized university textbooks the concept of quantum field is usually introduced through a procedure called "canonical quantization". The procedure considers the electromagnetic field as a paradigmatic case for transforming a classical field in a quantum one and it consists in replacing the numbers representing the coefficients of the Fourier expansion of the classical solutions of the d'Alembert equation with operators.

Every other quantum field (for example the Klein-Gordon field for particles of mass  $m$  and zero spin) is constructed extending such a procedure by analogy: *i)* take the generic solution of a wave-equation (for example the Klein-Gordon equation) expressed as Fourier expansion on plane waves; *ii)* focus on the coefficients of the expansion and *iii)* elevate them from numbers to operators by defining their commutation (bosons) or anticommutation (fermions) rules (Mandle & Shaw, 1984).

The procedure can be easily justified in terms of “technical effectiveness”: It follows maybe

---

<sup>1</sup>translated from the Italian version

the shortest way to arrive at the core-problem of constructing the new theoretical entities; it allows an inner coherent formalism to be developed and experimental predictions to be made. Nevertheless, *what is hidden behind the formal step?*, i.e., *what really happens when we transform a classical field into a quantum one (when the field is “quantized”)?*

The questions have been object of both a philosophical and a conceptual analysis whose main results are presented in the next sections. They will represent the basis for re-considering some problematic points PER has to face for producing a culturally meaningful educational reconstruction of CP, i.e a reconstruction that, still avoiding complicated formalisms, is able to respect and exploit the inner essence of Quantum Field Theory (QFT).

### **3. Results of the philosophical analysis: the need of keeping a certain level of complexity for avoiding dangerous hypersimplifications**

The Stanford Encyclopedia of Philosophy (Kuhlmann, 2009) reports the following questions as examples of problems that triggered the young philosophical investigation about QFT:

- What are particles at all?
- Can quantum particles be any more legitimately understood as “particles”, although in a broadest sense, when their localization properties are taken into account?
- How can one decode what a quantum field is and can “quantum fields” in fact be understood as fields?
- Instead of fundamental quantities, whatever this could mean, is it rather more appropriate to think, for example, of quarks as properties or processes or events?

All these questions raise specific philosophical issues that, according to the reconstruction reported in the Stanford Encyclopedia, can be seen as variations or sub-topics of the major philosophical debate involving QFT: The search for an ontology of QFT by confronting the particle and the field interpretation. The lively debate led supporters of the particle interpretation and of the field interpretation to produce effective arguments for showing to what extent the notion of quantum field rises complex interpretative problems.

The supporters of the particle interpretation of QFT ground their main arguments in what is observed in some experiments: The observed ‘particle traces’ on photographic plates of bubble chambers are said to be a clear indication for the existence of particles. Nevertheless, at least three problems stand out as major problematic elements against a particle interpretation of QFT: *a)* the problem of localization; *b)* the problem of vacuum; *c)* the Unruh effect.

On the other hand, the main argument supporting an ontology of QFT in terms of field rests on the formal similarity between the classical fields and the so-called *field operators* which lies at the basis of the mathematical formalism of QFT: As shown in the previous section, the transition from a classical field theory (like electromagnetism) to quantum field theory can be characterized by the transition from the field to the quantum field. In technical terms the construction of the quantum field is based on the formal similarity between mappings  $\mathbf{x} \mapsto \varphi(\mathbf{x}, t)$ ,  $\mathbf{x} \in \mathbb{R}^3$ , and  $\mathbf{x} \mapsto \hat{\varphi}(\mathbf{x}, t)$ ,  $\mathbf{x} \in \mathbb{R}^3$ . Even though this formal similarity between classical and quantum fields is the main reason why QFT is taken to be a field theory, whether such a similarity actually justifies this conclusion is matter of discussion. In particular, since no operator can be assigned to spacetime points (see Section 4) the quantum field seems to lack an essential feature of the classical one so that the expression ‘quantum field’ would be justified only on a “perverse reading” of the notion of field (Teller, 1995).

The philosophical debate on QFT is very young, but it provides at least two important warnings that can act as constraints for a sensible reconstruction of QFT from an educational perspective: *a)* hyper-simplifications can distort essential aspects of QFT world-view; *b)* a sharp choice of a pure and unproblematic interpretation of QFT in terms of either particle or field does not allow to synthesize all the main features of a quantum field.

#### **4. Results of the conceptual analysis: the need of clarifying what is hidden behind the canonical procedure of quantization**

The canonical procedure (by constructing the quantum electromagnetic field by elevating the coefficients of the Fourier expansion of the classical solution to operators) is at risk of suggesting very simplified images of a quantum field: A continuous object that, spread over spacetime (a field), operates punctually for producing or destroyed particles (an operator).

Moreover, the formal analogy, by means of which the canonical procedure builds every quantum field starting from the electromagnetic one, seems to suggest (or to assume) that the classical versions of the fields to be quantized not only exist, but also have a physical meaning. But, are we sure that, for example, the classical Klein-Gordon (KG) field exists and has physical meaning? If so, what is the meaning of the classical KG field on which the canonical procedure acts for constructing the quantum KG field?

The problems reported above are examples of questions hidden behind the relatively simple formal steps of the canonical procedure and not explicitly faced even in university textbooks of theoretical physics. They have been object of a detailed analysis (Bertozzi, 2010a) whose main results are:

1. Strong arguments can be formulated against the ideas that a quantum field is simply a continuous object that, spread over spacetime, operates punctually for producing or destroyed particles. The axiomatic approach to QFT, although technically more complex than the canonical procedure, gives back a conceptually more transparent image of quantum fields.
2. The classical KG field does not exist. Hence, the formal analogy, through which the canonical procedure builds the KG field starting from the electromagnetic one, cannot be “lightly” extended to a conceptual level.

In more details:

1. The quantum field cannot be thought as an operator acting directly on Hilbert space, or even a function entirely performable in ordinary space and time. The strongest argument against the idea of quantum field as an operator acting on Hilbert space is that, if one makes the quantum field to act on one particular state of Hilbert space (the ground state), the resulting vector is not yet a well-defined Hilbert state, having an infinite norm. As remarked by Haag: “The quantum field at a point cannot be an honest observable. Physically this appears evident because a measurement at a point would necessitate infinite energy. The mathematical counterpart is that is not really an operator in ” (Haag, 1996).

On the other hand, searching for its “classical features” (suggested by the “sense of continuity” highlighted by the canonical quantization) one could wonder whether field operator keeps the important feature of a classical field of being represented (made visible) by the “profile” of a continuous function.

The classical field representation is strictly related to its being the result of the superposition of plane waves, each of them taken with its “weight” factor, that is the coefficient representing the amplitude of each plane wave. When we “elevate” the coefficients from complex numbers to operators, it becomes trivially impossible to interpret them as amplitudes of normal modes. As a consequence, the possibility of any visualization is lost, as well as any sense to search for a space and time profile.

So, if it cannot be thought as an operator acting directly on Hilbert space, or even a function entirely performable in ordinary space and time, what is what we call “operator field”?

In order to develop this point the so called “axiomatic theory of fields” (Haag, 1996) has been analysed (Bertozzi, 2008).

In the axiomatic approach quantum field is introduced through the notion of “operator valued distribution” over spacetime and formalized as a theoretical construction interfacing spacetime and Hilbert space. Quantum field  $[\phi(x)]$  is mathematically and rigorously

formulated as a distribution which has to be averaged (“smear out”) with smooth functions  $[f(x)$ , called “test functions”] (eq.1).

$$\phi(f) = \int \phi(x)f(x)d^3x \quad (1) \quad )^2$$

The result  $[\phi(f)]$  of averaging the field over the test functions is what acts on Hilbert space. With respect to the canonical procedure, the axiomatic approach is more complex from a technical point of view. Nevertheless its conceptual interest as well as its potential in interpreting the relevant features of quantum interaction is without doubt remarkable (Bertozzi, 2008).

2. The KG equation in QFT is a fundamental equation for the description of relativistic spinless and massive particles (such as pions or kaons). Within the canonical quantization it represents the simplest and, formally, the most similar equation to the d’Alembert one. Starting from this consideration, our study aimed to investigate if the formal analogy can be extended to a conceptual level in order to complete the symmetry between the two equations. In more detail: taken for granted that the d’Alembert and the KG equations are related, respectively, to the description of photons and relativistic massive particles in the QFT framework, and that the first one has a clear interpretation also in classical electromagnetism, what are the classical meanings of the KG equation?

This problem required a deep and extremely detailed analysis regarding the investigation of the possible meanings of the KG equation in the different areas of Physics (Bertozzi, 2010b).

The main result of the analysis is that, although the classical solution of KG equation gains meaning in some areas of Physics (for example within Newtonian Physics it is related to the description of coupled pendulums in a gravitational field), in none of these cases the solution of the KG equation describes something that can be called "classical KG field".

The study then confirms the statement of Ryder "KG field, is a strictly quantum field" (Ryder, 1985) by providing a new and articulated argumentation. On this basis it becomes possible to conclude that the formal analogy stressed by canonical quantization in the construction of quantum fields is broken at a conceptual level, at least when it refers to the KG field.

## **5. Analysis of teaching proposals on Quantum Field Theory produced within Physics Education Research**

A selection of exemplar teaching proposals have been considered and analysed (see table 1) in order to explore: *how the introduction of quantum field is managed when the issue of introducing element of particle physics at secondary school level or introductory university courses is faced.*

---

<sup>2</sup> Usually, in the textbooks (see Haag, 1996), this expression involves an integration over Minkowski spacetime, as well as a quantum field with a more complicated structure  $[\phi(x) = f^-(x) + f^+(x)]$ . For our goals and for the case we are considering (non relativistic field) a spatial integration and a field with only the creation part ( $\phi(x) = f^+(x)$ ) are enough.



Paper	Reference
A reappraisal of the mechanism of pion exchange and its implications for teaching of particle physics	Peter Dunne, Preston College, Fulwood Campus, Preston PR2 8UR, UK Physics Education, 37 (3), May 2002
<b>Electrons as field quanta: A better way to teach quantum physics in introductory general physics courses</b>	<b>Art Hobson</b> , Department of Physics, University of Arkansas, Fayetteville, Arkansas 72701 Am. J. Phys. <b>73</b> (7), July 2005
Learning quantum field theory from elementary quantum mechanics	P. Gosdzinsky and R. Tarrach, Departament d'Estructura i Constituents de la Matèria, Universitat de Barcelona, Diagonal 647, Barcelona Am. J. Phys. <b>59</b> (1), January 1991
<b>Particles, Feynman diagrams and all that</b>	<b>Michael Daniel</b> , King Edward's School, Birmingham, UK Physics Education <b>41</b> (2), March 2006
<b>Quanta – Mi</b>	<b>Marco Giliberti</b> , Quanta-MI, teaching material used in the course “Teoria dei campi e proposte didattiche di fisica quantistica. La proposta di Milano” within the IDIFO Master, Udine <b>M. Giliberti, L. Lanz, L. Cazzaniga</b> , Quanta-MI: a modern teaching for modern physics in preservice teachers training, Paper presented at the international GIREP Conference (2002)
<b>Teaching conservation laws, symmetries and elementary particles with fast feedback</b>	<b>Ed van den Berg and Dick Hoekzema</b> , Centre for Science and Mathematics Education, Utrecht University, Netherland Physics Education <b>41</b> (1), January 2006
<b>Conservation laws, symmetries, and Elementary Particles</b>	<b>Dick Hoekzema, Gert Schooten, Ed van den Berg, and Piet Lijnse</b> , The Physics Teacher Vol. 43, May 2005
The calculated photon: Visualization of a quantum field	Martin Ligare and Ryan Oliveri, Department of Physics, Bucknell University, Lewisburg, Pennsylvania 17837 Am. J. Phys. <b>70</b> (1), January 2002
The nature of force in particle physics	J Allday, King's School, Canterbury, UK Physics Education, <b>32</b> (5), 1997
The two-slit interferometer reexamined	E.C.G. Sudarshan and Tony Rothman, Center for Particle Theory, University of Texas, Austin, Texas 78712 Am. J. Phys. <b>59</b> (7), July 1991

**Table 1. List of the inspected papers**

What emerges as a general result of the analysis is that all the proposals choose *the canonical quantization* as approach of reference and, at the same time, they aim at *removing the formalism* or *keeping it to an absolute minimum*.

The problematic aspects of this double aim come out when the constitutive role played by the formalism in the canonical procedure is taken into account: The quantum field is built on the *formal process* of transforming the coefficients into operators and canonical quantization is built on a *formal analogy* between different fields. The goal of giving back discursively “the shift field to field-operator” and “the formal analogy” is a real challenge.

In front of such a challenge, the solutions proposed in the papers make it explode the conceptual problems hidden (and somehow “saved”) by the formalism in university specialized textbooks:

- While the classical field is presented as a continuous quantity defined over space and varying with time according to appropriate wave equations, the quantum one is introduced as an operator which, for every point in space, can act on vacuum creating states of definite momentum and energy. According to this presentation “quantization” appears as the formal

procedure that turns a classical field into an operator able to act punctually over the spacetime and capable of creating particles from vacuum.

- The formal analogy between electromagnetic field and matter fields (including the case of KG) is extended to linguistic and conceptual level so as to push students to anchor their imagination about quantum matter fields to something somehow visualizable in their mind. Typical expressions are, for example; “since light is a wave in a field, analogously, “matter is a wave in field”. The images evoked by sharp statements like these are, in the light of the analysis carried out, rather questionable because they hidden the meaningful differences between classical and quantum picture of the world as well as between matter fields and interaction ones.

## 6. Final remarks

The analysis carried out on foundations of QFT and on the teaching proposals on CP led us to conclude that significant PER efforts have been developed in order to translate QFT formalism into a “natural” language.

At the same time the nature of the problems that CP sets to PER and communication of physics cannot be ascribed to a pure matter of “translation” since they grounds their roots in crucial issues not yet sufficiently explored at fundamental and conceptual level.

For this reason a meaningful educational reconstruction of QFT must foresee, in its agenda, studies explicitly devoted to go deep into foundations. This point is particularly demanding since the philosophical reflection and the research on foundations of QFT and elementary particle physics is very recent and not as articulated as the reflection on other physics domains, like quantum physics or relativity: It then requires, as in our case, to create a working group where different competences, coming from theoretical physics, foundations, philosophy and physics education) are implemented, tuned and exploited for a common cultural aim.

## References

- Berestetskij B., Lifshits M., Pitaevskij P. (1978), *Teoria quantistica relativistica*, Cap II, p.52 in Landau, Lifshits, *Fisica Teorica 4*
- Bertozzi E. (2009), "Quantum Field Theory: a perspective for analysing the relation between continuum and discrete", Proceedings GIREP 2008 Conference, MPTL 13th Workshop, Physics Curriculum Design, Development and Validation, Nicosia, Cyprus, August 18-22 ([http://lsg.ucy.ac.cy/girep2008/a\\_c.htm](http://lsg.ucy.ac.cy/girep2008/a_c.htm)).
- Bertozzi E. (2010a), *Reconstructing Quantum Field Theory from an educational perspective*, PhD dissertation
- Bertozzi E. (2010b), *Hunting the ghosts of a strictly quantum field: the case of the Klein-Gordon equation*, accepted for publication in *European Journal of Physics*
- Giliberti M., Lanz L., Cazzaniga L. (2002), *Quanta-MI: a modern teaching for modern physics in preservice teachers training*, Paper presented at the international GIREP Conference, *Physics in new fields and modern applications - opportunities for physics education*, August 5 - 9, 2002 Lund, Sweden
- Haag, R., *Local Quantum Physics, Fields, particles, Algebra*, 2.nd Revised and Enlarged Edition (Springer - Verlag, Berlin, Heidelberg, New York, 1992, 1996)
- Kuhlmann, M. (2009) "Quantum Field Theory", *The Stanford Encyclopedia of Philosophy (Spring 2009 Edition)*, Edward N. Zalta (ed.), URL = <http://plato.stanford.edu/archives/spr2009/entries/quantum-field-theory/>
- Mandle, F & G. Shaw (1984), *Quantum Field Theory*, John Wiley & Sons Ltd. Chichester, New York, Brisbane, Toronto, Singapore
- Ryder L.H. (1985), *Quantum Field Theory*, Cambridge University Press, p. 129
- Teller, P. (1995), *An Interpretive Introduction to Quantum Field Theory*, Princeton: Princeton University Press.

### 3.4 – Experiment proposalu

---

# Simple quantitative electrostatic experiments for teachers and students

Leoš Dvořák

Dept. of Physics Education, Faculty of Mathematics and Physics,  
Charles University in Prague, Czech Republic  
e-mail: [leos.dvorak@mff.cuni.cz](mailto:leos.dvorak@mff.cuni.cz)

## Abstract

The article presents low-cost experiments that enable to measure or at least estimate the values of charged straws, plastic rods or similar objects. First type of these measurements uses the Coulomb's law. Several possibilities how to calculate the charge that can be used either at high school or at university level are presented. The second method uses a capacitor and a cheap multimeter. It may elucidate the principle of charge meters provided for schools e.g. by Vernier and other companies. The series of experiments and calculations presented here can be regarded as an example of "multilayered simple experiments" approach presented at GIREP 2009 [1].

## Introduction

Students often have nearly no idea about the values of charges of some things around us, e.g. charged plastic rods, straws or even people themselves, for example when walking in shoes with rubber soles at plastic flooring. This lack of knowledge concerns not only high school students but also future teachers and physics teachers in schools. Even for them it is not easy to estimate the value of charge of plastic straw after being rubbed with a piece of cloth. Of course, it can be measured by a charge meter. But do teachers and students understand such measurements? How many of them could explain the principle of a charge meter? One can worry that quite often this special instrument is perceived rather as a "black box" somehow providing some results that cannot be checked in a different way.

Yet, charge is one of the most basic concepts of electrostatics and the whole area of electricity. So it is perhaps worth for teachers and students to know at least the order of magnitude estimates of charges in some concrete situations – and to be able to support and verify these estimates by simple and understandable quantitative measurements.

In the following text two types of such experiments are presented. The first one uses the Coulomb's law (and also, at a more sophisticated level, the Gauss's law) to calculate the value of the charge of a plastic straw, a rod or a similar object. The simplest method of calculation that can be used at high school level provides just very rough estimate. The calculation based on the Gauss's law gives, as we shall see, more precise results.

The second type of experiments enables to measure charge values by the same principle as is used in charge meters: i.e. by charging a capacitor of a known capacity. We shall see that a low-cost multimeter can be used in such measurements.

The experiments presented here were already used both in pre-service teacher training (in the seminar "Electricity and magnetism step by step" for future physics teachers at Charles University in Prague) and in in-service teacher training of Czech physics teachers (at the workshop at the conference "Heureka Workshops 2009" [2]).

## Simple hands-on experiments

The fact that a plastic straw rubbed e.g. by a paper napkin attracts small pieces of paper or sticks itself to a wall is well known. (Sometimes people are surprised how long a straw can

stay stuck to a wall; it may be for days.) Two plastic straws charged by rubbing repel each other. In fact, we can even feel the repulsion by our own hands. Try to hold the charged straws by your fingers as it is shown at Fig. 1. Your fingers will clearly feel the force preventing to bring straws closer to each other. (Of course, there is a “trick” in it – or rather a simple application of mechanics. The straws act as levers, with long lever arms at which the repulsion acts and a short lever arms at which we hold them in our fingers. That’s why the force we perceive is greater than we would expect.)

Our first experiment was just a qualitative one. But it is easy to convert it to a version which could enable us to estimate the values of charges of the straws.

Hold the straw horizontally as it is shown at Fig. 2. Hold the lower straw tightly so its position is fixed and let the upper straw be just freely supported by your fingers at the end. (You should prevent it from slipping to the side but let it be free to move up or down.) You will see that the upper straw will “float” (or hover) above the lower one. Of course, it is due to electrostatic repulsion. And it is this simple experiment that we can use for determining the approximate values of charges of the straws.

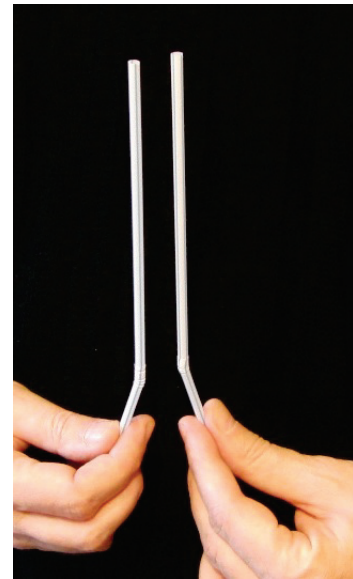


Fig. 1. How to feel the electrostatic repulsion by your own hands

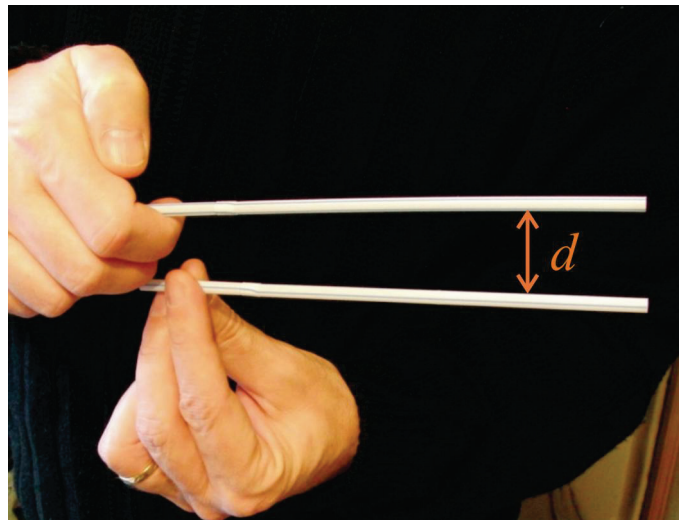


Fig. 2. Electrostatic repulsion causes the upper straw to hover above the lower one.

The distance  $d$  between the straws is typically about 2 cm. Sometimes, under good conditions, it may be up to 4-6 cm. (The straws should be clean and it is better to use a new paper napkin for rubbing them. It is not necessary to rub a straw many times; but the napkin should be pressed hard to a straw while rubbing.)

### How to determine $Q$

Grasping the principle of determining the value of charge is simple even at high school level. The electrostatic repulsion force balances the weight of the upper straw. By weighting the straw or, rather, several straws, we can find that the mass of the straw is about 0,5 g. (You

should weight your own straws, the mass of a particular type may be a bit different.) So its weight – and also the value of the electrostatic force  $F$  – is about 5 mN.

At **high school level** the Coulomb's law

$$F = k \cdot \frac{Q_1 Q_2}{r^2} = \frac{1}{4\pi\epsilon} \cdot \frac{Q_1 Q_2}{r^2} \quad (1)$$

is a natural starting point for determining the value of the charge  $Q$ . Here  $Q_1$  and  $Q_2$  are the values of charges,  $r$  is their distance and  $\epsilon$  is a permittivity of the surrounding air that we can take equal to the permittivity of vacuum  $\epsilon_0$  – or simply take  $k = 9 \cdot 10^9 \text{ Nm}^2/\text{C}^2$ .

If we take the charges of both straws to be approximately the same,  $Q_1 \doteq Q_2 = Q$ , it follows from (1) that

$$Q = r \sqrt{\frac{F}{k}} \quad (2)$$

For the distance  $r = 2 \text{ cm} = 2 \cdot 10^{-2} \text{ m}$  and  $F = 5 \cdot 10^{-3} \text{ N}$  the formula (2) gives  $Q = 1,5 \cdot 10^{-8} \text{ C} = 15 \text{ nC}$ .

Well, it is a very simple derivation – but even a high school student should now start to protest vehemently. The Coulomb's law is valid for point charges (or homogeneously charged spheres) – and the straws are far from being point-like!

So we should take our derivation as just a very crude approximation. How could it be improved?

At **university level** students learn the Gauss's law and can use it to calculate the electric field near an infinitely long uniformly charged straight line. The resulting formula is

$$E_R = \frac{\tau}{2\pi\epsilon R} = k \cdot \frac{2\tau}{R} \quad (3)$$

where  $\tau$  is the linear charge density and  $R$  is the distance from the line. The force acting at a charge  $Q$  at this distance is  $F = Q E_R$ . If we take the linear charge density at a straw of a length  $L$  to be  $\tau = Q/L$ , we can express the charge as

$$Q = \sqrt{L R \frac{F}{2k}} \quad (4)$$

The length  $L$  of the straw is about 16 cm. For the distance  $R$  equal to 2 cm formula (4) gives 30 nC.

Again, the derivation of (4) (now at introductory university level) was very simple. And again, (4) is surely just an approximation – the straws are not infinitely long.

We have now two approximations. A natural question can motivate both us and the students to further calculations. Can we estimate how good our simple estimates are?

### How precise are our estimates?

It may be a bit surprising that it is possible to derive an *exact* formula for the force between two finite homogeneously charged parallel rods – and the derivation is well in the scope of introductory university level. It may be a classical end of chapter task and perhaps it is present in some textbooks. But being just stated in a textbook the task could have been perceived as boring and artificial. Now it is interesting and attractive because we are motivated! Just how

much we were in error when using such absurd approximation as taking 16 cm long straw as a point charge or an infinite line?

We will not present the detailed derivation here, just the resulting formula. It reads

$$F = 2k \frac{Q_1 Q_2}{L^2} \left( \sqrt{1 + \frac{L^2}{d^2}} - 1 \right) \quad (5)$$

Where  $d$  is the distance between the straws (as it was denoted at Fig. 2). Considering again that the values of charge at both straws are the same we can derive the final expression for  $Q$ :

$$Q = d \sqrt{\frac{F}{2k} \left( 1 + \sqrt{1 + \frac{L^2}{d^2}} \right)} \quad (6)$$

It can be easily seen that the approximations (2) and (4) (where the distance  $r = R = d$ ) follow from (6) for  $L \ll d$  and  $d \ll L$  respectively. But it is more useful to compare results provided by different methods and approximations for the realistic values, i.e. for the straw length  $L = 16$  cm and the distance  $d$  from 1 to 5 cm. The comparison is presented in Tab. 1 and in Fig. 3.

distance $d$ of the straws	$Q$ determined by the formula (approximation):		
	taking straws as point charges - formula (2)	taking straws as infinite lines - formula (4)	exact result for finite rods - formula (6)
1 cm	7,5 nC	21 nC	22 nC
2 cm	15 nC	30 nC	32 nC
3 cm	22 nC	37 nC	40 nC
4 cm	30 nC	42 nC	48 nC
5 cm	36 nC	47 nC	55 nC

Table 1 – Comparison of charge values provided by different approximations

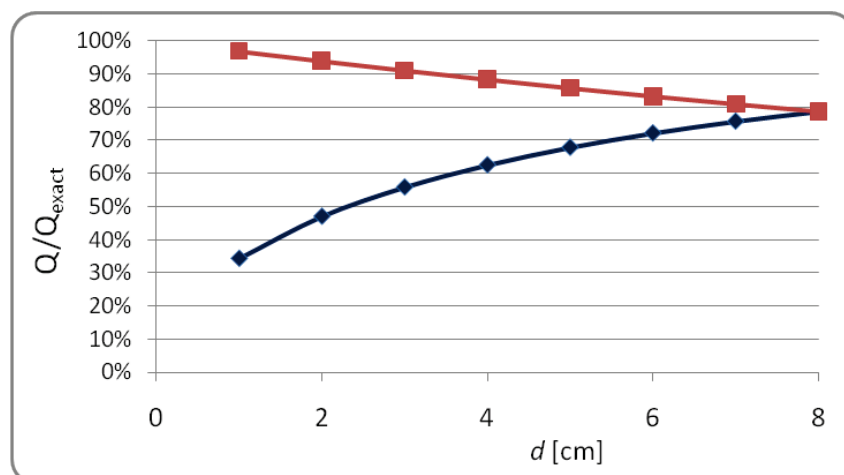


Fig. 3. Relative value of charge with respect to the exact value provided by the approximation taking straws as point charges (blue points) and as infinite lines (red points).

We can see that the calculation based on the Gauss's law provides rather good approximation of the real value of charge despite the fact that the straws are far from being infinite. The error

is less than 15 % for distances  $d$  up to 5 cm; the approximation slightly underestimates the true value of the charge.

It may be surprising that even a very crude approximation taking straws as point charges, provides results that are not orders of magnitude wrong. This method underestimates the values of charges about twice or three times for distances in the range 1-3 cm and it is even better for larger distances. (We can discuss with students that this is partly due to the presence of a square root in the formulas.)

Even the calculation based on the Coulomb's law could be made much more precise if we took the straw as a series of point charges. This approach will be described elsewhere.

Finally, it is worth to note (and to discuss with students) that even the "exact formula" (6) could not provide absolutely precise values of charges in real situations. (6) was derived for the case of two parallel uniformly charged infinitely thin rods of the same length. In reality the charge will not be exactly uniformly distributed, the charges of both rods may differ; the straws are not strictly parallel, the presence of our hands distorts the electric field etc. So we should be aware that our method provides just more or less precise estimates of charges on straws.

### **Another method: how to measure charge by a capacitor and a cheap multimeter**

The following method can be used to illustrate the principle of charge meters. The basic idea is simple, see Fig. 4. The charge, for example from a charged can, charges a capacitor of a known capacity  $C$ . The voltage on the capacitor is then measured by a voltmeter.

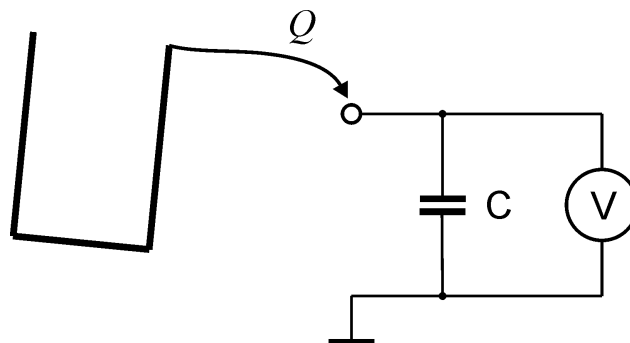


Fig. 4. The principle of measurement of a charge by a capacitor and a voltmeter

A simple formula from high school physics,  $Q = CU$ , is sufficient to determine the charge  $Q$ . For a capacitor of the capacity  $C = 1\mu\text{F} = 10^{-6}\text{ F}$  the voltage  $U = 1\text{ mV} = 10^{-3}\text{ V}$  corresponds to the charge  $Q = 10^{-9}\text{ C} = 1\text{ nC}$ . Even a cheap multimeter has a sensitivity and resolution of 0.1 mV so charges in the range of several nanocoulombs to microcoulombs can be safely measured. (Of course, the real multimeter will discharge the capacitor – this problem will be discussed later.) There is also one obvious practical advantage of the above mentioned setup: if we switch the range of the multimeter to millivolts the display will show the values of charges directly in nanocoulombs.

### **The real experiment and its limitations**

The above mentioned idea is very simple. So why the measurement of charges is not implemented to most of ordinary multimeters and a special charge meters must be used?

The problem was already mentioned above. The multimeter has a finite input resistance and discharges a capacitor. The input resistance of cheap multimeters (when measuring a voltage) is typically equal to 10 M $\Omega$ . (Some very cheap multimeters have the input resistance just



1 M $\Omega$ , those are not suitable for our measurement at all.) The time constant of discharging the capacitor is  $\tau = RC = 10\text{ s}$ , so in 10 s the voltage falls e-times. This is quite fast but our setup can still be used for approximate measurements. In the first second the voltage drops by 10%, in two seconds by about 20%. If we read the number at the display fast enough we obtain usable results.

The real setup of our simple experiment is shown at Fig. 5. It can be seen that also this method confirms that a charge at a plastic straw is several tens of nanocoulombs. The multimeter also shows that the charge is negative.



Fig. 5. The real measurement of a charge by a capacitor and an ordinary multimeter

We will not discuss here any technical details of an experimental setup. (Let us just note that the capacitor should *not* be electrolytic.)

Apart from an obvious disadvantages of this measurement (the necessity to read the value very quickly, the expected error of 10-20%) there are also some advantages: the simplicity of the overall setup, the clear illustration of the principle of charge meters and also the possibility to measure values of charges exceeding the range of charge sensors supplied for example with dataloggers and computer measurement systems for schools. Our setup can be therefore used for measuring charges of large plastic rods or charges of people acquired by walking at some types of floors.

## Conclusions

The experiments and measurements described in this article can be used for teaching and learning of electricity (especially electrostatics) at various school levels, from high school to university. They are examples of “multilayered simple experiments”(see [1]) that can be used at various levels and discussed to various depths. Such experiments provide “increasing cognitive demands” that helps develop students’ knowledge and understanding.

Hopefully some of the experiments mentioned here might be used in the future in programs like “Physware”. Up to now the earlier versions of these experiments were used in in-service teacher training of Czech physics teachers in the Heureka project [2] and also in pre-service training of future physics teachers, in both cases with a positive response. It is planned that they will be used also in other future courses for physics teachers.

Part of this study was supported by the development project 14/38/2010 of Ministry of Education, Youth and Sports of Czech Republic: “Support of informational centres and cooperation with high schools and the public at Faculty of Mathematics and Physics, Charles University in Prague”, partial project “Heureka and development of teacher training of physics teachers”.

## References

- [1] Planinšič G., Dvořák L.: *Multilayered simple experiments: an approach with increasing cognitive demands*. In: Physics Community and Cooperation: Selected Contributions from the GIREP-EPEC & PHEC 2009 International Conference, Ed. D Raine, C Hurkett, L Rogers (Lulu/The Centre for Interdisciplinary Science, Leicester, 2010) ISBN 978-1-4461-6219-4.
- [2] The Heureka Project: Annual conference in Nachod. (and following pages) Available online: <http://kdf.mff.cuni.cz/heureka/en/index.php?page=annual-conference>

## **Physical properties of prism foil and its pedagogical applications**

Mihael Gojkošek, [gojkosek@fmf.uni-lj.si](mailto:gojkosek@fmf.uni-lj.si)

Gorazd Planinšič, [gorazd.planinsic@fmf.uni-lj.si](mailto:gorazd.planinsic@fmf.uni-lj.si)

Faculty of mathematics and physics, University of Ljubljana, Slovenia

### **Abstract**

Transparent prism foil is part of the backlight system in modern LCD monitors that are widely used today. Its main function is to optimize the angular distribution of the light incident on the back side of the LCD panel. The foil can be obtained by dismounting any used LCD monitor. In this paper we explain the basic theoretical model of the foil and present several simple experiments that demonstrate or exploit optical properties of the foil. We will show that prism foil can be very useful in several pedagogical applications, which include optical phenomena such as refraction, diffraction and image formation. It will be also shown that the foil can be used as an essential part of a simple laboratory experiment that gives reasonably accurate measurements of index of refraction for liquids. Finally, as a part of high-tech based, easy available device, the prism foil can be seen as motivation resource that encourages positive attitude towards science and technology.

### **Introduction**

Prism foil is part of common LCD monitors. It employs basic concepts of optics in intriguing way. The price of LCD monitors today is low enough that buying a new monitor is often cheaper than repairing a faulty one. Though this is not in line with sustainable development, it gives an easy access to LCD monitor parts, including the prism foil described here. Before we continue with the examples, let us describe briefly how to get the prism foil and what is its main function in LCD monitors.

Vaguely speaking LCD monitor consists of a power supply, electronic circuit and screen. The screen consists of LCD panel, where image is formed and the backlight module, which further consists of light source (usually one or two tubular fluorescent lamps) and several layers that prepare the optimal light for viewing the image that forms on the LCD panel [1,2]. Prism foil (called also backlight enhancement film) is one of the foils in backlight module. The main task of this foil is to refract usable light towards the viewer and reflect most of the remaining light back into the display, where it is recycled. Using the prism sheet the viewing angle of light that emerges from the screen is compressed in one direction, increasing the display brightness. More information about prism foil including material safety data can be obtained at [3]. Though disassembling the used LCD monitor is rather straight forward task, one should be careful when removing and handling the LCD panel because it consists of glass plates that can easily brake.

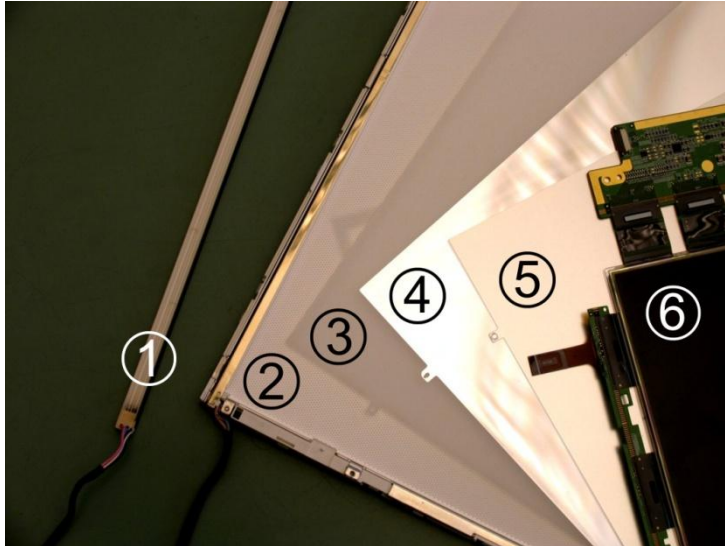


Figure 1: Structure of a typical LCD monitor screen (starting from the back of the screen): 1-fluorescent lamp, 2-light guide plate, 3-first diffusive foil, 4-prism foil, 5-second diffusive foil, 6-LCD panel with part of the electronics.

### Simple observations

Let's start with simple observation. Parallel beam of light incident perpendicularly to one side of the foil splits symmetrically into two outgoing beams at angles of about  $30^\circ$  with respect to normal (Figure 2a). If the foil is turned around so that the light beam strikes its other surface, almost all the light is reflected back, leaving the space behind the foil dark (Figure 2b).

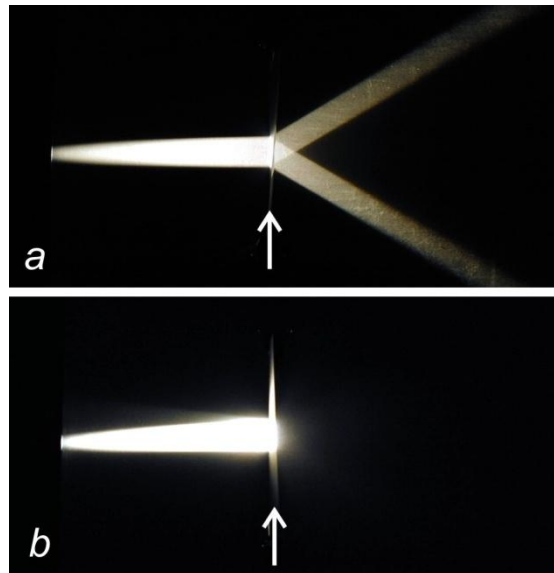


Figure 2: a) light beam incident perpendicularly to one side of the sheet splits into two symmetrical beams; b) if incident on the other side of the sheet, light beam gets reflected. The arrows indicate the position of the sheet.

The structure of the foil is revealed if it is observed under the microscope. Figure 3a shows top view of the foil with 0.2 mm copper wire placed on top of it to set the scale. Figure 3b shows the side view of the foil (a thin stripe has been cut and placed with cross-section facing up under the microscope). Observations under the laboratory microscope suggest that the foil consists of prismatic ridges with angles of about  $90^\circ$  at their apices and with distance of about 0.05 mm between the neighbor apices. The thickness of the prism sheet is about 0.15 mm. Using a better microscope the distance between the ridges was determined to be  $48.2 \pm 0.6 \mu\text{m}$ .

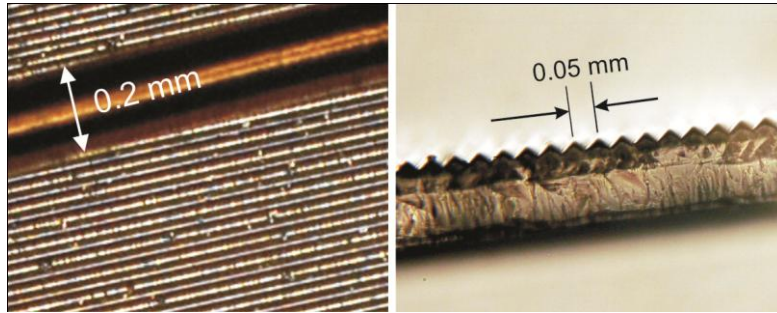


Figure 3: Prism sheet: a) top view and b) side view under the laboratory microscope. A 0.2 mm copper wire has been placed on the sheet to set the scale.

### Simple theory

We shall assume that the prism foil consists of prismatic ridges with angles of  $90^\circ$  at their apices. First let's study the simple case when the parallel light beam is incident perpendicularly to the flat surface of the prism foil. If the index of refraction of the foil is larger than  $\sqrt{2} \approx 1.414$  then the light beam undergoes total internal reflection and returns back into the original direction (Figure 2b and Figure 4a). If index of refraction is smaller than 1.414 then the light beam undergoes simple refraction at the prism surface (dotted lines in Figure 4a).

If parallel beam of light is incident perpendicularly to the prism side, the beam undergoes two refractions and emerges at angles  $\pm\theta_0$ , depending on which side of the prisms the beam strikes (Figure 4b).

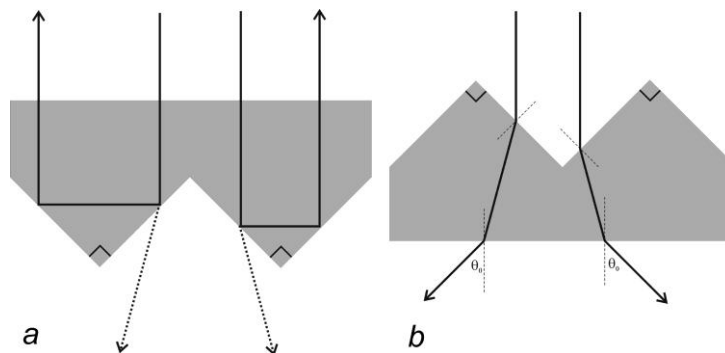


Figure 4: Light beam incident perpendicularly to a) the flat side and b) to the prism side of the foil.

The angle  $\theta_0$  can be calculated using simple geometry and the Snell's law at both boundaries. After short calculation the following expression can be found

$$\sin \theta_0 = \frac{1}{2}(\sqrt{2n^2 - 1} - 1), \quad (2)$$

which can be rearranged to express the index of refraction as a function of the emerging angle

$$n = \sqrt{2\sin^2 \theta_0 + 2\sin \theta_0 + 1}. \quad (3)$$

In our case we measured  $\theta_0=30^\circ\pm 1^\circ$  what gives  $n=1.58\pm 0.02$  and corresponding critical angle of  $39.3^\circ$ . Measured index of refraction matches reasonable good with 1.5750, the index of refraction for polyethylene terephthalate (also known as Dacron), which is the reported material that prism foils are made of [4].

General case of refraction of light can also be studied, where light ray is incident on some arbitrary angle to the both flat or prism side of the foil. Comparison of laboratory measurements and results from simple optics analysis shows good agreement of those. Analysis of the general case will be published elsewhere.

### Third medium

Let's see what happens when light beam is incident perpendicularly to the flat side of the foil and a third transparent medium (a liquid for example) covers the prism side of the foil. In case this third medium has high enough index of refraction  $n_l$ , the light beam does not undergo total internal reflection at prism sides but it is rather refracted into the new medium. If the third medium surface on the air boundary is flat, two symmetrically emerging light beams at angles  $\pm\theta$  are observed (see Figure 5). Measurements were made with green laser pointer ( $\lambda=532$  nm).

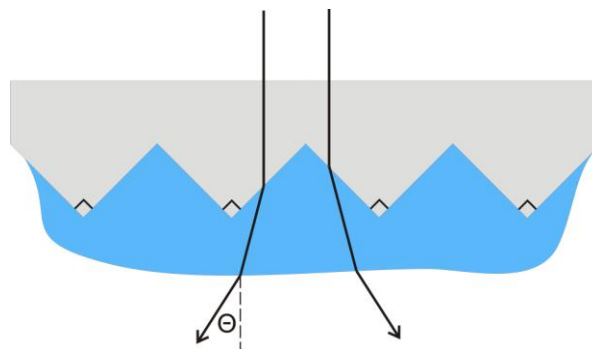


Figure 5: Refraction of laser light incident on flat side of the foil when some liquid is present on the prism side.

Using simple trigonometry and the Snell's law the following expression relating  $n_l$  and  $\theta$  can be found

$$n_l = \sqrt{\frac{(n - 2 \sin \theta)^2 + n^2}{2}}. \quad (8)$$

By measuring the angle  $\theta$  and knowing the index of refraction of the prism foil this expression can be used to determine the index of refraction of the medium  $n_l$ . The range of indices  $n_l$  that give observable effect depends on the value of  $n$ . In our case  $n=1.58$  what gives the range for  $n_l$  from 1.11 to 1.57. This range is wide enough to cover most of liquids used in everyday life. Comparison between the indices of refraction for some common liquids measured with the prism foil and values measured with research quality refractometer are shown in Table 1. The method proved to be useful as a first year student project task or home experiment for students.

	$n$ (refractometer)	$n$ (prism foil)
Water	1.332	1.33
Vinegar (5%)	1.337	1.34
Olive oil	1.467	1.44
Ethanol	1.362	1.36
Glycerin	1.452	1.45
Paraffin oil	1.466	1.46

Table 1: Indices of refraction for some common liquids as measured with research quality refractometer and with the prism foil.

### Interplay between refraction and diffraction

It is interesting to examine the foil with a laser light more carefully. In the experiment described in this section we used green laser pointer with wavelength of 532 nm and observed the light pattern on the screen which was about 2 m away from the prism foil. Laser beam incident perpendicular to the prism foil in forward direction produces on the screen symmetrical pattern with brightest points in the directions at about  $30^\circ$  with respect to incident beam direction (Figure 6). If incident perpendicularly to the opposite side of the prism foil, again almost all laser light is reflected.



Figure 6: Pattern obtained on the screen when laser beam is incident perpendicularly to the foil in forward direction. The photography has been inverted.

The observed diffraction pattern is the result of combined effect of diffraction and refraction. In the incident laser beam wavefronts can be treated as plane waves. At the boundary with prism foil wavefronts bend due to refraction but since the distance between neighbor prism ridges  $a$  (in our case about  $50 \mu\text{m}$ ) is comparable to the wavelength of light the wavefronts are

no longer planar but curved due to diffraction. At the rare side of the prism foil wavefronts bend again due to refraction and interfere when they meet.

At large distance from the prism foil interference can be treated in a similar way as this is usually done for diffraction grating bearing in mind that the direction of propagation of wavefronts has been changed due to double refraction (see Figure 7).

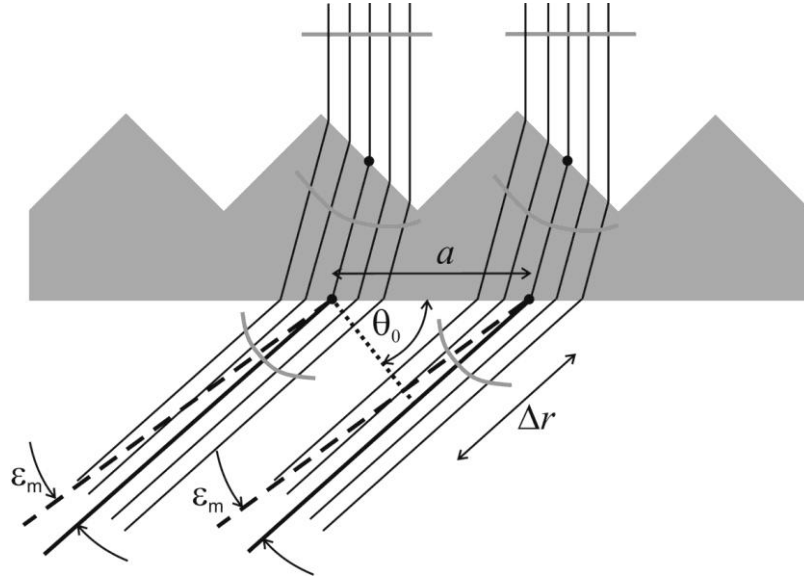


Figure 7: Diffraction of laser light after passing through the prism sheet. For clarity only incidence on two right sides of prism ridges is shown.

The expression for angular positions of maxima (relatively to the direction of  $\theta_0$ ) can be given in following form:

$$\varepsilon_M = \arcsin\left(\sin \theta_0 + \frac{M\lambda}{a}\right) - \theta_0; \quad \text{where } M = 0, \pm 1, \pm 2 \dots \quad (9)$$

For the maxima close to the angles  $\pm\theta_0$ ,  $|\varepsilon_M| \ll \theta_0$  and therefore the approximate angular positions are given with the following expression

$$\varepsilon_M = \frac{M\lambda}{a \cos \theta_0}. \quad (10)$$

This expression is similar to small angle approximation of well known diffraction grating formula, except for the cosine factor. As shown in the Table 2 measured values agree reasonably well with values calculated from equation (10). In order to minimize the error of projection we rotated the experimental setup, so that one of the main outgoing beams was perpendicular to the screen. Note that theoretical expression takes into account also the observed asymmetry in diffraction pattern.



This experiment has important pedagogical value even if we perform no measurements. In textbooks refraction and diffraction are always treated as separate phenomena and to our knowledge no example has been described where these two phenomena occur simultaneously. Presented experiment with prism sheet offers excellent opportunity to demonstrate the interplay between refraction and diffraction in a simple but efficient way. Alternatively, the experiment can serve for testing students' ability in applying acquired knowledge in a new situation.

$M$	$\varepsilon_M(\text{calc.})[^\circ]$	$\varepsilon_M(\text{meas.})[^\circ]$
8	5.97	5.9
7	5.2	5.2
...	...	...
3	2.19	2.2
2	1.46	1.5
1	0.71	0.7
-1	0.71	0.7
-2	1.44	1.3
-3	2.15	2
...	...	...
-7	4.95	4.8
-8	5.64	5.6

Table 2: Measured and calculated angular positions of diffraction maxima.

### Prism sheet and image formation

Prism foil can produce virtual images of objects that are placed behind it. Theoretically the same images could be obtained with a single prism [5] but in practice this would require prism of unusually large size (and considerable weight).

Place a flat object (such as pocket calculator or mobile phone) on the table on its long narrow edge. Bring prism foil close to the object and observe the image. If prism side is facing the object, only the reflected light can be seen but if it faces the observer, a double-view image that reveals both sides of the object appears behind the foil (see Figure 8a). Image formation can be qualitatively explained by tracing the rays from two extreme points on the object (Figure 8b).

Each of the two images is showing the object as rotated for approximately  $30^\circ$  and  $-30^\circ$  from the original position. This can be easily explained assuming the observer is very far from the prism sheet. In this case the rays entering observer's eyes are nearly parallel. In our case emerging parallel rays can only be obtained if the incident rays are forming the angle  $\pm 30^\circ$  with normal to the prism foil (see Figure 4b with reverse directions of the light beams). The situation is schematically shown in Figure 8c. If size of the object is  $b$ , than distant observer can see the projection of the object which is equal to  $a = \cot(60^\circ)b$ . The apparent tilt angle of

the object can be estimated also from the ratio of the dimensions on the photography. The estimated value for the tilt angle in our case is  $27^\circ$ .

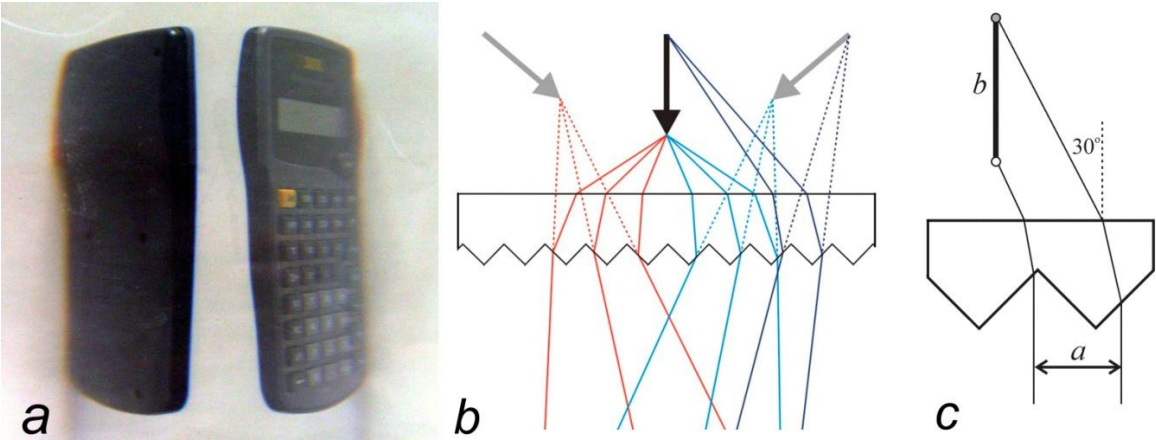


Figure 8: Double-view image of the calculator that is placed near the prism sheet: a) photo of the image, b) image construction, c) sketch for the simple derivation of the image tilt ( $a$  is the size of the object and  $b$  is the size of the image as seen by the very distant observer).

If two objects are placed symmetrically further behind the prism foil so that the viewing angle of them measured from the sheet is around  $60^\circ$ , their virtual images will overlap straight in front of the observer behind the foil. Figure 9a shows two texts and their combined image as seen through the prism foil. Figure 9b shows qualitative explanation of image formation in this case. Note that the image of the foil of paper which is placed between the texts perpendicularly to the board is not visible from the point of observation since it is formed outside the prism foil frame.

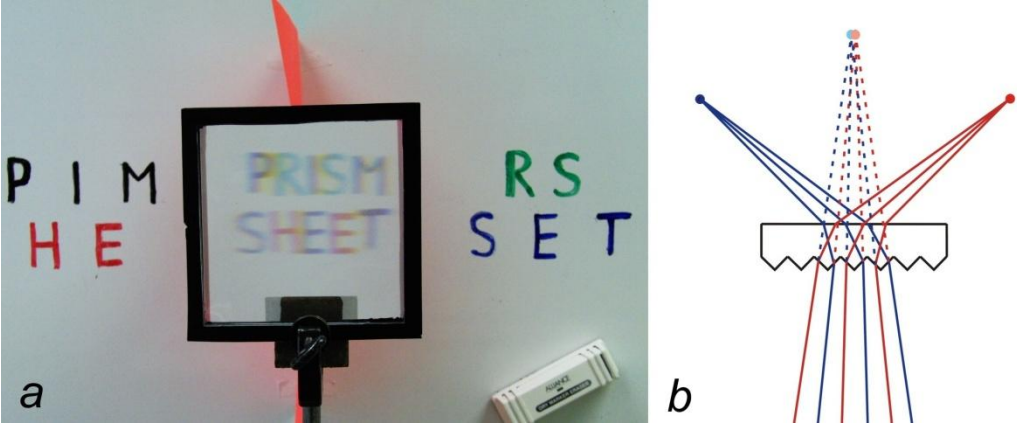


Figure 9: a) overlapping image of two texts that are written on the whiteboard (note that the image of the foil of paper which is placed between the texts, perpendicularly to the board, does not appear in the image); b) image construction.

## Conclusions

Prism foil is component of HI-tech device. By using such items in school physics becomes more relevant to our everyday lives, which usually results in higher motivation for learning. The important advantage of the prism foil is that it employs simple physical concepts. For this reason its pedagogical applications make it useful in both introductory and advanced course of optics. On one hand prism foil can be used in nontrivial experiments that require from students to apply the acquired knowledge in a new situation. On the other hand, most of the experiments with prism foil can be explained using knowledge of basic physics.

Using prism foil we showed experiments in which two different optical phenomena (diffraction and refraction) occur simultaneously. Experiments with that combination of optical phenomena are rare and problems like that require from students to think critically. Prism foil also offers simple way how to measure the index of refraction for common liquids with reasonable accuracy. The idea can be starting base for student project work. According to several interesting experiments analysis of the prism foil can be part of the context rich problems and since it is generally not very well known object it can be used to test students' ability to construct explanatory models (see plenary talk paper). At last but not least, you can get the prism foil from some broken LCD monitor for free.

## References

- [1] Y. Koyama: "Ray-Tracing simulation in LCD development," Sharp Technical Journal 80, 51-55 (2001)
- [2] C. J. Li et al.: "Design of a prism light-guide plate for an LCD backlight module," Journal of the SID 16 (4), 545-550 (2008)
- [3] [http://solutions.3m.com/wps/portal/3M/en\\_US/Vikuiti1/BrandProducts/secondary/optics101/](http://solutions.3m.com/wps/portal/3M/en_US/Vikuiti1/BrandProducts/secondary/optics101/)
- [4] [http://www.suntech-web.jp/pdf/suncrysta\\_2008.pdf](http://www.suntech-web.jp/pdf/suncrysta_2008.pdf)
- [5] I. Galili and F. Goldberg: "Using a linear approximation for single-surface refraction to explain some virtual image phenomena," Am. J. Phys. 64 (3), 256-264 (1996)

## **Eurodiffusion – how the physicist study the society**

Mojca Čepič and Katarina Susman,  
Faculty of Education, University of Ljubljana, Slovenia

### **Abstract**

The paper reports the study of coin mixing after introduction of Euro to Slovenia. The share of Slovenian Euros decreased with the characteristic time around 700 days. The result was found by an empirical study which is an example of methods used in physics applied to studies in society. As many students of physics are later employed in companies performing social studies, the example can be used as a model study for formation of research questions, hypotheses and for getting acquainted with problems typical for studies in society. As the way of presentation in social studies differ from reporting in physics, the paper follows the combination of the physics and social types of presentation as additional information for a student of physics.

### **1. Introduction**

Students of physics are later often employed in various institutions which perform studies in society like public opinion measurements. They are usually well trained in the extraction of conclusions from various scattered data, which is typical for these kinds of studies. But the studies performed in society differ significantly in obtaining data from designed experiments in the laboratory. The example reported in this contribution has a physical connotation but possess typical problems of studies in society as well. It can enlighten students with respect to the problems they might expect in their future work. Also the reporting methods of social research studies differ from what we are used in physics [1, 2]. Therefore we intentionally wrote this report mimicking the style that is required in journals devoted to methodological studies. We state the research questions explicitly, form hypotheses, for which we use the reasoning of the physicist – the Fermi calculations [3] - and define the methodology of the study [1, 2].

Everything mentioned above is presented within the study of a phenomenon interesting from the physicists point of view as well – the mixing of Euro coins. It is also an illustrative example of a macroscopic diffusion from everyday life. Models and analogies are always welcome in physics [4]. We use the study of this phenomenon as an example of a study performed in the society during lectures for students of physics. The mixing of coins is a typical phenomenon having the number of unknown variables; it could also serve as a nice example for Fermi calculations. In addition, it is interesting also by itself and presents a life model for the epidemical studies.

Let us shortly describe the phenomenon studied: In January 2007 Slovenia associated to European monetary union (EMU) and accepted the common European currency – the Euro. Euro coins of all EMU countries have the same tails, portraying a map of Europe, but each country has its own design on heads of the coins. Head designs are chosen nationally and enable to distinct coins by “nationality”. Examples of Slovenian, German and Irish national coins can be seen in Fig. 1 and the whole set of European coins is found in [7-I]

Initial release of coins consisted of Slovenian coins only. Due to the frequent travelling of citizens as well as frequent visitors from abroad, the coins started to mix. The mixing of coins could be considered as an example of diffusion on the level of macroscopic objects. The process

we named Eurodiffusion. The Eurodiffusion was followed from the very beginning of Euro introduction for two years in the capital city of Slovenia, in Ljubljana.

The Eurodiffusion in Europe was studied before. When Euro was first introduced in Europe in 2002, there were some initiatives for following-up the process of mixing [8]. A few months after our study was already running we found data about similar studies in Germany, Belgium and France. Accidentally we used the same name for our study as the authors of these studies – Eurodiffusion. Unfortunately, the studies were not systematically introduced in Europe and personal initiatives varied in methods and in the data acquired [5, 6, 8]. The studies were based on volunteers what diminished the diversity in the sample. The unique opportunity in the history, the study of mixing process when the same currency was simultaneously introduced in different countries with the possibility to distinguish between coins of different national origins was unfortunately lost.



**Figure 1** Few examples of coins. Coins differ in heads. Some countries decided that all coins differ (like Slovenia), some grouped the motifs on coins (like Germany) and some have all the coins of the same design (like Ireland).

The presented study can motivate lecturers in countries where the Euro currency will be introduced in future to perform a similar study in vivo enabling at least some generations of students to experience also the practical part of a physical-sociological study.

The paper is organized as follows. In Sec. 2 we discuss the research questions we tried to answer with this study. The Eurodiffusion study combines the pedagogical methodology with physical estimation (Fermi calculation) of some parameters used for the formation of hypothesis. In Sec. 3 we present the details of the empirical study, analysis of the acquired data i.e. experimental results and estimations for our country such as the characteristic time in which the share of Slovenian Euros became one third ( $1/e$ ) of the initial share. Further on we also discuss problems we were dealing with during the implementation of the empirical study. We found many problems with sustaining the motivation, avoiding fake reports etc. Even more, the researchers in contact with people can very easily influence the results by their action. The point of objectivity and reliability is usually not the case in physics. To show such aspects to the students of physics is important as the effect of measurements on the measured phenomenon in physics can usually be predicted and estimated. Finally, in the Sec. 4 we conclude and we suggest some new questions, which can be studied in the future when Euro will be introduced in new countries.

## 2. Research questions and Fermi estimations

The mixing of Euro coins from different countries is an example of macro diffusion. By the term of macrodiffusion we understand the random movement of macroscopic objects which can be described by processes very similar to diffusion on the microscopic level. Different heads of coins having different nationalities allowed for following their mixing (Figure 1 and [7-I]).

The aim of the study was to find the answers for few research questions (Q1-Q3) that can be answered by following the contents of the “average purse”:

Q1: *What was the initial share of Slovenian Euros in an average purse?*

Q2: *What is the characteristic time of the Slovenian coins i.e. how long would it last that the share of Slovenian coins would decrease to  $1/e$  of its initial value?*

Q3: *Which nationality of coins is (are) most common and how its (theirs) share changes?*

The questions in our research are typical Fermi questions [3], where firm data is not known. The only information about possible values of variables we had from everyday experience. The situation is therefore rather useful to provide students few Fermi type estimations as a starting point of the research. We therefore present the Fermi reasoning and corresponding predictions for the research questions.

*The Fermi estimation for Q1:*

The coins come in units of 1 cent, 2 cents and 5 cents, 10 cents, 20 cents and 50 cents, 1 Euro and 2 Euro. For comparison, the price of one coffee in Slovenia is around 1 Euro in the students' canteen and could be up to two Euros in a bar or a restaurant. According to our personal experiences, an average purse contains around ten different coins. If less, the problems in small cash-payments, like coffee, arise, if more, the purse becomes rather heavy. Again, according to our personal experiences the total amount of money in the purse is between 2-4 Euros.

Because the release of Slovenian Euros consisted of Slovenian Euros only (Fig. 1- second line), the initial concentration of Slovenian Euros was high, but not 100 %. Due to the previous travels of citizens, some Euros were kept at home and people started to use them when Euro was introduced. Typically we can assume that each person who travelled to Euro region few times a year had one average purse of coins at home. We can also assume that this was not true for non-frequent travellers, because they tried to get rid of foreign currencies before re-entering the

country. The “to get-rid” approach was probably reduced in last few months before the introduction of Euro.

Slovenia is a small country having only 2 millions of inhabitants, approximately 300 km of diameter in east-west direction and about 150 km in north-south direction (Fig. 2). Due to the vicinity of the border from practically every point of Slovenia, many people often travel across the border for shopping and for pleasure trips during the weekends. The number of travellers having the Euros at home at the introduction of currency can be estimated to few out of ten. Therefore we expect the similar result for the average purse, *few out of ten coins* should be of foreign origin at the beginning.



Fig. 2: Map of Slovenia with major cities. The wider borders with Austria and Italy represent the borders with countries having Euros, while the narrower borders with Croatia and Hungary represent the borders with countries having their own national currency.

*The Fermi estimation for Q2:*

Practically all of the tourists visit the capital city Ljubljana. They bring the coins of their nationality with them. The events of exchanging money are not correlated; therefore they are similar to diffusion. If observed at a single place, the mixing is similar to decay. Because Slovenia is so small, the Eurodiffusion is more similar to the decay also in the sense that one could not expect significant spatial variation in the concentration of coins having different nationalities across the country. The observation of the coin mixing at one place would therefore give the relatively good information about the mixing process anywhere in the country.

The expected time dependence of domestic coin concentration is

$$n_{\text{SLO}}(t) = (n_{\text{SLO},0} - n_{\text{SLO},\infty}) e^{-\frac{t}{\tau_{\text{SLO}}}} + n_{\text{SLO},\infty}, \quad (1)$$

where  $n_{\text{SLO}}(t)$  is the percentage or share of Slovenian Euros in an average purse at the time  $t$  measured in days after introduction of Euro. The initial percentage of Slovenian coins is  $n_{\text{SLO},0}$  and the expected percentage of Slovenian coins after a long time is  $n_{\text{SLO},\infty}$ . The characteristic time  $\tau_{\text{SLO},\infty}$  is the time when the difference  $(n_{\text{SLO}}(t) - n_{\text{SLO},\infty})$  decreases to  $1/e$  of the initial value  $(n_{\text{SLO},0} - n_{\text{SLO},\infty})$ . It has the same meaning as the life time for radioactive elements. The value depends on travelling habits of citizens and the flow of tourists and business people.

The only airport in Slovenia has around 30 arrivals from the Euro region having approximately 50 passengers per flight, which gives around 1500 travellers per day. In addition, the border can be passed by public transport (unfortunately practically negligible) and, of course, by cars and tourist busses. The number of tourists that reach Slovenia by land is few times greater than the number of those, who reach the country by plane. Rough estimation of all border crossings would be around 5000 people per day having 50.000 coins in their purses.

We estimate that three quarter of inhabitants (excluding rather young and rather old people) i.e. to one million and a half exchange the money and posses around 15 millions of coins in different units.

Assuming that the “travellers” exchange the coins brought to the country with the coins present in the country, we get the change of the concentration of Slovenian coins

$$\frac{\Delta n_{\text{SLO}}(t)}{\Delta t} = \frac{\frac{\text{number of travellers' coins}}{\text{day}}}{\text{number of all coins in SLO}} = \frac{50.000}{15.000.000} \frac{1}{\text{day}} = \frac{0,33\%}{\text{day}} \quad (2)$$

which could lead to the estimation of the characteristic time if one would know the concentration of Slovenian coins after a long time. This is exactly the research question Q3. Let us continue to Fermi estimation of Q3 before the final estimation for the Q2.

*The Fermi estimation for Q3:*

We assume that the number of coins in the circulation is proportional to the national gross product. The value  $N_{\text{SLO},\infty}$  could therefore be estimated from the data for the national gross products for the countries in Euro region [11]. Two million of people present less than 1 % of inhabitants in Euro region. Having in mind that Slovenian gross product is lower than the product of many other countries with larger populations; this share is expected to be even lower.

It seems reasonable to assume that the *final share of Slovenian coins* is within the fluctuation limit and can be considered as *negligible*. From the aspect of collectors, we can expect that the Slovenian Euro coins will in future be more expensive than the value they carry (due to their predicted rarity), although this would probably not happen as a new releases of domestic coins replace worn out coins having various origins from time to time.

Returning to the estimation for the Q2 and equations (1) and (2), we can recognize the relation between the characteristic time (1) and the decrease of concentration (2) as



$$\frac{dn_{\text{SLO}}(t)}{dt} = -\frac{1}{\tau_{\text{SLO}}} n_{\text{SLO}}(t) = 0,33\% \quad \text{and} \quad \tau_{\text{SLO}} \approx 300 \text{ days}, \quad (3)$$

giving the estimation of a few hundred days.

To recollect - the Fermi calculations assisted the formation of hypotheses corresponding to research questions:

H1: The initial share of foreign coins would be few out of ten coins.

H2: The characteristic time would be around hundreds of days.

H3: Most common would be coins of countries with the highest gross product.

### 3. Empirical study of the “average purse”

Choosing the population for the research sample is one of important issues in studies of society. In observational studies to which also our study counts, the representative group of people is chosen. This group should consist of people being representatives of the whole population on which the results are referring to. In our case we wish to unite the conclusions for the whole population of Slovenia. It means that the representative sample should include people that differ in gender, age, social status, place of leaving, etc. Since our study was based on volunteers, we were able to perform the survey among students only. The measurements of the time dependent concentration of Slovenian as well as foreign coins were carried out in a single place, at the Faculty of Education, University of Ljubljana. The student’s purse was considered as the average purse. Persons that contributed the data were mainly students from different parts of Slovenia, from families of different social statuses, however of similar age. In spite of this insufficiency we expected that their average purse is still very similar to the average Slovenian purse, in the amount of money in coins as well as in their distribution with respect to nationalities.

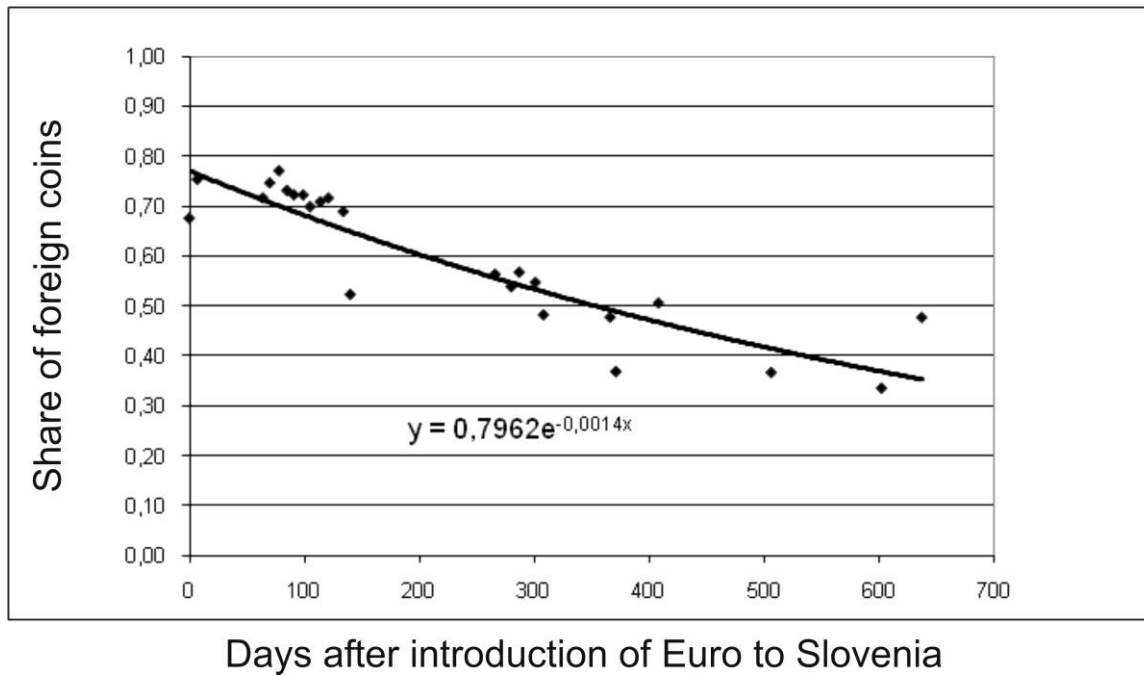
The measurement was performed in the following way: students who attended physics for prospective primary school teachers; students, who attended physics for prospective physics teachers, and occasionally other people, were asked to count the coins in the purse (Table 1, column 1). They counted coins of Slovenian origin (Table 1, column 2) and they sorted the rest of the coins by nationalities. They were given the picture of coins for a help. Numbers of coins were entered into corresponding columns. The rows in the table were filled anonymously by different students. At the beginning of 2007, the tables were filled once a week, later on the data was taken less frequent. Last measurements were taken once a month.

Number of coins	SLO	Austria	Belgium	Finland	France	Greece	Ireland	Italy	...	Unknown

**Table 1** Table of sorting results given to students. The columns have all the Euro region countries except Vatican, Monaco and San Marino because their coins were released for collecting purposes only. The last column was meant for coins of unknown origin, like special issues, and in 2008 for Malta and Cyprus as well.

At the beginning, when Euro was fresh and we were all enthusiastic, typically about 60-80 students contributed the data. After a year, it became an exacting piece of work to persuade students for spending two minutes of counting coins and filling the table. Therefore the numbers

of coins were later much smaller than at the beginning. During the 2009 we occasionally repeated the counting but due to low number of participating students the data was not very reliable anymore. Therefore we decided to analyze only data acquired until the end of 2008, within (the) two years after the introduction of Euro in Slovenia. Within this period there were also no additional coin releases according to National bank of Slovenia. The raw data of measurement can be downloaded from [11]. The time dependence of percentage of the Slovenian coins is given in Fig 4. It is clearly seen that the percentage of Slovenian coins decreases. The data are less scattered at the beginning, when the students were more enthusiastic to identify the origin of coins, as mentioned before. However, as this is the only data available, we tried to extract some hints about characteristic time. The concentration dependence vs. time is given by Eq. (1) having in mind that  $N_{SLO,\infty}$  is equal to zero.



**Figure 4** The time dependent share of Slovenian Euros.

From the best exponential fit (Fig.1) one can get the initial concentration of average coins (around 80 %) and the characteristic time

$$\tau_{SLO} = \frac{1}{0,0014} \text{ days} \approx 700 \text{ days}. \quad (5)$$

It is clearly seen that the characteristic time is of the same order of magnitude as the Fermi prediction.

Although the measurement seems rather simple, there are few traps that one has to avoid.

For the measurement one has to rely on willingness of people (students) to contribute information about their purse content. Although the procedure is strictly anonymous, the students are asked about the content of their purse which actually means the small money; still, some people felt a certain inconvenience with respect to this question. As a consequence some of them were not willing to contribute the data.

In addition, they had to contribute a part of their free time during the break or the lecturer had to contribute a part of the lecture time. In both cases some students considered the activity as stealing their free time and some were not willing spending it on sorting of coins. The number of such students increased over the period of study. When they had got familiar with most of the coins of various nationalities, they lost the interest and they were not willing to sort the contents of their purses anymore.

The closer look to graphs shows a gap in the series of data, which corresponds to the holidays. As the number of people sorting the coins has to be rather large, it was impossible to perform measurements during holidays. The strict measurements over the well defined time period was extremely important at the beginning of the measurement when the changes were expected to be the largest. Unfortunately, from the viewpoint of this study of course, Slovenian universities have a semester break from 15<sup>th</sup> of January until 15<sup>th</sup> of February. In addition, one of the authors who was giving the lessons to participating students was absent for additional three weeks. We naively expected that students were also interested in measurements and we asked them to make the sorting each week as a voluntary homework. This homework could have replaced one of the obligatory homework. When the procedure was introduced to students, we mentioned that we expected the rate of foreign coins would increase and the rate of Slovenian coins would decrease. We also mentioned the aim of the measurement, to find the characteristic time and the dynamic of the expected exponential decrease of the Slovenian coins share. We were greatly disappointed after the analysis of data from voluntary homework. Comparison of data given by students with data of “in-situ” measurements when lectures continued showed that most of the students simply faked the results. The idea of getting one homework’s score improvement was too tempting to admit the truth: the non-willingness to perform the sorting. As they did not have any ideas about the decreasing rate, their artificial results were exaggerated and a significant increase in the percentage of Slovenian coins appeared when we continued with the “controlled” measurements at the faculty. This experience shows straightforwardly how easy is to influence the society with some deliberate hints and how hard is to control the volunteers in the social research.

#### **4. Conclusions and open questions**

In this contribution we reported a unique study of coin mixing after introduction of Euros in Slovenia. The Eurodiffusion – the inflow and outflow of coins having different “nationalities” to the country is presented through observation of coin concentration changes. The characteristic time of concentration for domestic coins was measured and some rough estimation of characteristic times for two nationalities of coins is given as well.

As the measurement was “once in the Earth’s life time” opportunity few research questions appeared during the study which could not have been answered. Slovenia is rather small and it is hard to expect that spatial variation of concentration would be important. However, for a larger country having few borders to Euro region this question could also be interesting – for instance, the newcomer Slovakia has only one short border with Euro region and probably also air transfer

to Bratislava airport is more significant than other airports. This could give rise for a spatial dependence of the Slovakian Euro concentration. Another good candidate for the spatial study will be Poland when the country enters the European monetary union. There are more incoming points (airports) and a long Euro border as well.

Another attractive question considers following the Eurodiffusion separately for each of the coin value. Our own purse's observations gave the hint that the mixing is faster for Euro coins and slower for the cent coins. This is also well known fact to collectors [5, 6]. The possible explanation would be that people tend to get rid of large heavy coins and do not worry much for giving away small and light cent coins. Therefore lighter coins spent in general more time in one's purse. But this is only a guess. The behaviour is probably general and could be a part of future studies in new Euro countries as well. Unfortunately this separate mixing within classes of coins was not systematically followed.

To conclude, the mixing of Euro coins of different nationalities is a longitudinal activity for students, which is possible only once, when the country enters Euro region. It presents the living model and example of diffusion processes. Raw data obtained in our country can be downloaded from [7-III] and can serve as an exercise or as a preparation for the study and for comparison with new measured data, during the undergraduate lectures of physics. The study is also interdisciplinary and can offer students some experiences with complexity of social studies. As it is well known that physics students are later often employed in various other fields, such an activity can give students a deeper insight in situations where research includes people and their (re)actions. The closest examples are different studies within the science education research and various epidemiological studies.

We believe that the presented example can serve as a motivation for looking across the "borders of physics" for phenomena in society which could deserve the attention and the approach of the physicists. In addition, the presented study can give students a hint about possible problems they may encounter in such studies. The study is also strongly interdisciplinary, and sociological aspects are connected to physical models. This interdisciplinary connection is rather rare. Students can also become familiar with experimental methods in social sciences where the approaches are significantly different from methods used in natural sciences. Finally, introduction of the new currency - the currency which is common for many countries- is a solitary event, which does not offer any possibilities for recapitulation. The study can lead to the students' awareness that many situations and accidents can be lost forever if the observation is not carried out at the time of the accident. Therefore we would like to stimulate future members of Euro region to repeat the measurements and obtain typical values for their countries. We encourage the lecturers and students in the future Euro region countries to study some issues, which shown up as relevant during our study, but for us the opportunity was already lost.

[1] I. Devetak, J. Vogrinc, S.A. Glažar, *Assesing 16-year-old students' Understanding of Aqueous Solution at Submicroscopic Level*, Res. Sci. Ed. DOI 10.1007/s11165-007-9077-2 (2009).

[2] D. T. Brookes, E. Etkina, *Force, ontology, and language*, Phys. Rev. Spec. Top. – Phys. Ed. Res. Topics **5**, (2009) 010110 -


[3] C. Schwartz, *Back on the envelope physics*, The John Hopkins University Press, Baltimore, (2003).

- [4] G. Marx, *Simulations of science*, Phys Educ **16**, (1981) 212-217
- [5] D. Stoyan, *Statistical Analysis of Euro Coin Mixing*, Math. Spec. **35**, (2003) 50-55.
- [6] D. Stoyan, H. Stoyan, G. Doege, *Statistical Analysis and Modelling of the Mixing Process of Euro Coins in Germany and Europe*, Aust. N. Z. Stat **46**, (2004) 67-77.
- [7] [http... supplementary materials: I images of coins, II raw data of coin counting in Slovenia, III gross products of countries in Euro region.](#)
- [8] <http://www.mathe.tu-freiberg.de/inst/stoch/Stoyan/euro/en/euro.html> (14<sup>th</sup> October 2010).

**Supplementary materials (to be presented at the personal web page, if the paper is accepted)**

Country	0,01€	0,02€	0,05€	0,10€	0,20€	0,50€	1€	2€
Head								
Slovenia								
Germany								
Italy								



Austria								
France								
Netherlands								
Belgium								
Spain								

Greece								
Portugal								
Finland								
Ireland								
Luxemburg								



Cyprus								
Malta								
Slovakia								

Supplementary material I: Coins of Euro region; rare examples (Vatican, San Marino and Monaco), which are not regularly used, are not presented.

<b>Country</b>	<b>population [millions]</b>	<b>population [% of Euro region]</b>	<b>GDP (nominal) [billion]</b>	<b>GDP /capita [thousands]</b>	<b>% in cumulative Euro region BDP</b>
Slovenia	2	0,61	46	22,9	0,37
Austria	8	2,43	317	44,8	2,55
Belgium	10,5	3,20	454	42	3,65
Cyprus	0,8	0,24	21	27	0,17
Finland	5,5	1,67	246	46,9	1,98
France	65	19,78	2593	48	20,85
Germany	82	24,95	3320	40,4	26,70
Greece	11	3,35	314	29	2,52
Ireland	4,5	1,37	285	65	2,29
Italy	60	18,26	2104	35,7	16,92
Luxembourg	0,5	0,15	50	103	0,40
Malta	0,4	0,12	8,5	20,7	0,07
Netherlands	16,5	5,02	909	54,4	7,31
Portugal	10,5	3,20	255	24	2,05
Slovakia	5,4	1,64	75	18,6	0,60
Spain	46	14,00	1439	32	11,57
 Euro region	 328,6		 12436,5		

Supplementary material II: Financial data for Euro region (<http://en.wikipedia.org/wiki/>)

<b>date</b>	<b>days from start</b>	<b>all coins</b>	<b>SI</b>	<b>AT</b>	<b>BE</b>	<b>FI</b>	<b>FR</b>	<b>GR</b>	<b>IR</b>	<b>IT</b>	<b>LU</b>	<b>DE</b>	<b>NL</b>	<b>PT</b>	<b>SP</b>
10.1.07	0	623	441	41	2	0	8	6	1	45	0	36	2	0	6
17.1.07	7	1105	747	97	11	1	30	8	2	116	1	87	8	1	15
15.3.07	64	603	455	44	3	0	15	2	0	34	0	38	7	1	4
21.3.07	70	530	380	50	4	2	8	3	1	40	0	33	2	0	3
29.3.07	78	570	426	34	2	0	5	3	1	47	0	36	3	0	9
5.4.07	85	451	348	26	4	1	5	8	1	43	0	29	3	0	5
11.4.07	91	377	276	30	4	1	5	2	2	31	4	23	2	0	3
19.4.07	99	419	303	40	3	0	6	4	3	39	0	23	2	1	7
25.4.07	105	213	154	18	0	0	1	0	0	13	0	22	2	0	4
4.5.07	114	163	114	14	1	0	4	1	1	14	0	11	1	0	2
11.5.07	121	141	100	13	1	0	1	0	0	12	1	12	1	0	0
24.5.07	134	452	324	50	4	1	9	1	0	43	0	31	4	0	6
30.5.07	140	190	131	11	2	0	0	0	0	17	0	15	3	0	1
3.10.07	266	1035	541	132	6	0	28	9	3	111	3	157	4	5	29
17.10.07	280	900	507	95	10	1	22	8	2	88	0	137	7	4	25
24.10.07	287	273	147	30	1	2	6	3	1	33	0	34	3	0	4
7.11.07	301	215	122	22	1	0	5	0	1	24	0	34	1	0	5
14.11.07	308	479	262	64	2	1	19	3	4	48	1	66	2	0	16
11.1.08	366	193	93	34	2	0	8	1	2	20	0	25	2	0	4
16.1.08	371	302	144	38	2	1	9	3	0	39	2	25	9	1	16
22.2.08	408	136	50	19	1	6	4	2	1	23		23		1	6
30.5.08	506	184	93	33	1	0	3	2	0	25	0	38	3	0	1
3.9.08	602	246	90	70	1	0	5	1	3	38	2	35	4	1	7
8.10.08	637	368	123	61	4	2	12	13	2	43	0	63	8	2	10
30.11.08	690	319	152	37	3	9	9	6	38	66	0	29	6	10	8

Supplementary material III: Raw data of coin counting (from January 2007).

# “Magnetic damping”: Quantitative experiments with MBL sensors

Pasquale Onorato and Anna De Ambrosis

pasquale.onorato@unipv.it

*Department of Physics "A. Volta", University of Pavia, via Bassi 6, I-27100 Pavia, Italy*

## Abstract

We propose a sequence of experiments with the goal of exploring electromagnetic induction phenomena and “magnetic friction” forces. The experiments have been tested with high school students in the context of a program of cooperation between our Physics Department and the Regional School District.

The experiments involve permanent magnets and conductors (a coil of wire or an aluminium plate) in relative motion. Motion and current-voltage online sensors allow real time measurements of position, velocity and induced voltage and provide graphs of these quantities vs time.

The role played by the intensity of the induced current in determining the damping of oscillations due to the “magnetic braking” is stressed. To this aim the coil is connected to an external circuit with a variable resistance and students can observe how the damping of the oscillations increases when the circuit resistance decreases and can relate the variation of the mechanical energy of the system to the production of thermal energy in the circuit.

## 1. Introduction

Electromagnetic induction is a significant subject in college and undergraduate physics courses and it is extremely difficult for most students [1]. Unlike mechanics, where many situations involve familiar macroscopic objects, more abstract concepts such as field and flux [2] are often discouraging for students. Moreover several studies have emphasized students’ conceptual troubles in understanding the role of magnetic field flux and its time variation [3-6] in experimental configurations.

Both demonstrations [7] and experiments [8-10] about electromagnetic induction have been designed to help students overcome their learning problems while some recent studies analyzed both from a theoretical and experimental point of view the magnetic braking [11-14]. In this paper we propose an experimental approach to the study of magnetic induction which starts from the observation of the magnetic braking force acting on a moving conductor (a coil of wire or an aluminium plate) as it passes between the poles of a permanent magnet. The behaviour of this complex system is modelled by means of a sequence of experiments aimed at:

- studying from a quantitative point of view the characteristics of the force acting on a metallic sheet entering and exiting from a region where a magnetic field is present;
- analyzing the role of ohmic resistance in establishing the strength of magnetic braking on a conductor moving in a magnetic field. For this purpose a simple experimental set up is used where the ohmic resistance of the conductor can be easily varied.

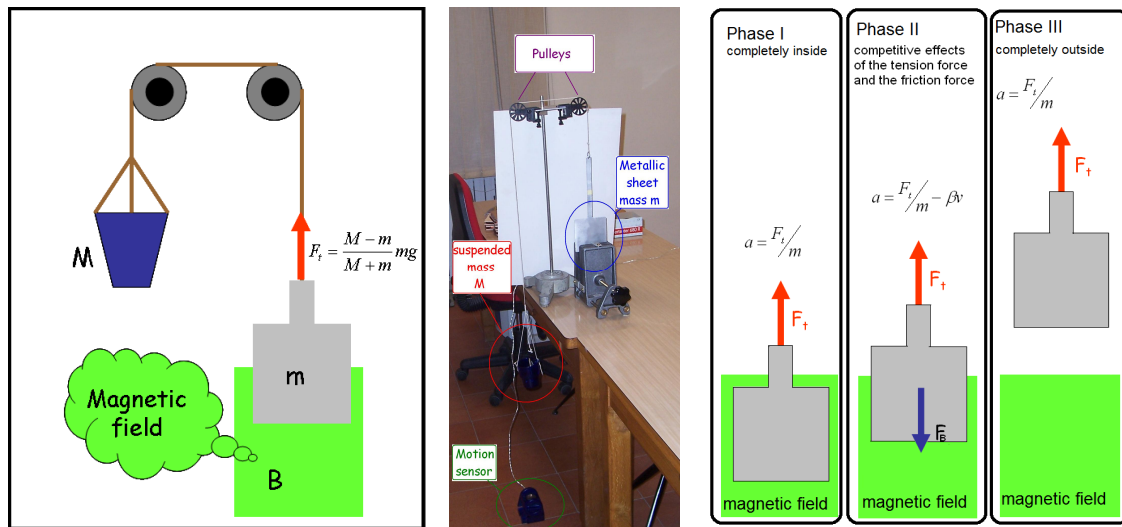
An interpretation of the experimental results is given from the energy point of view by comparing the transfer of mechanical energy in thermal energy through electrical resistive dissipation with the work done by a viscous like friction force. This approach allows students to understand how the magnetic braking depends on the value of the resistance in the circuit and to correlate the theoretical model to the experimental results.

The experiments were carried out by employing on-line sensors (Microcomputer Based Laboratory) to acquire data and to create graphs in real time. The activities are designed to create an environment where students gain experience of electromagnetic phenomena. Students can recognize how the variation of the flux of B field is the quantity always involved in these phenomena and for this reason it is the quantity used to describe and to interpret them.

## 2. The “magnetic friction force”

When a non-ferromagnetic metallic plate passes between the poles of a magnet, eddy currents are induced in the conductor as the plate enters and exits from the field (Figure 1, left). The action of the magnetic field on the induced currents produces a braking force. The problem posed to the students is: what kind of forces act on the conductor?

To explore this phenomenon students are invited to use an equipment which allows to quantify the force acting on the metallic sheet and to study its properties: the aluminium plate, mass  $m$ , is now pulled through the magnetic field by a falling mass  $M$  as in a kind of Atwood machine (Figure1, right).



**Figure 1** - Experimental apparatus to measure the strength of the “magnetic friction force” (Right) A metallic sheet of mass  $m$ , is connected by a string over a pulley to a falling mass  $M$  and is pulled through a magnetic field. (Middle) A motion sensor on the floor gives the position as a function of time of the sheet moving through the magnetic field. (Right) The different phases during the motion: an accelerated motion when the sheet is completely inside (I) or completely outside (III) the magnetic field region, and a motion governed by the competitive effects of the tension force and the magnetic braking force when the sheet is partially outside (II).

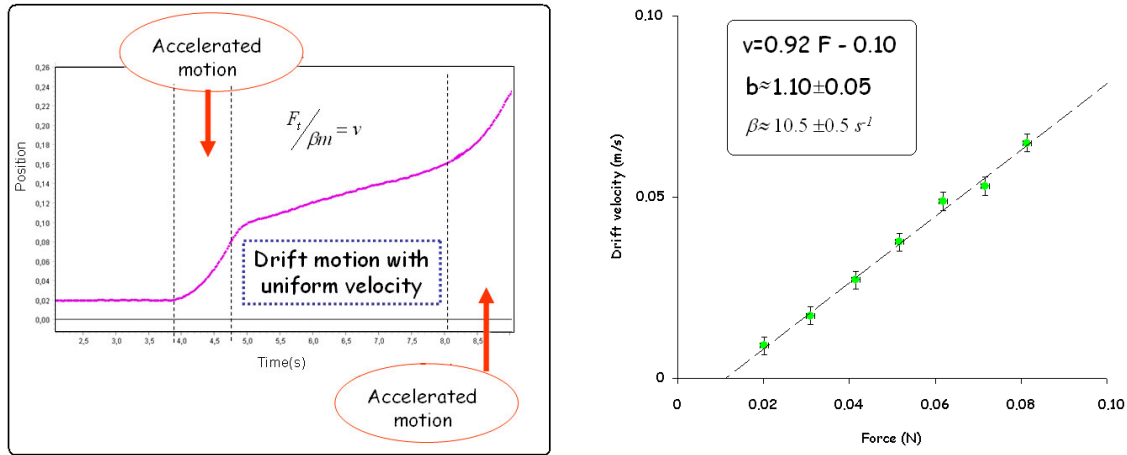
Thanks to the measurements made with a motion sensor [15], graphs of position versus time are obtained (Figure 2). Three different phases (Figure 1.Right) can be recognized in the movement of the metallic sheet: an accelerated motion when the conductor is completely inside the magnet, a uniform motion with a drift velocity  $v_d$  when the plate is partially inside, an accelerated motion when the sheet is completely outside. Thus students observe the

presence of a “braking force” only when the sheet is exiting from the magnetic field. When the motion of the sheet is uniform this force has the same value as the tension force,

$$F_T = ma_T = \frac{M - m}{M + m} mg$$

By changing  $M$  it is possible to study the relation between  $F_T$  and the drift velocity  $v_d$  reached by the sheet and measured by the motion sensor. Experimental data, reported in Figure 2 Right, show the linear dependence of  $v_d$  on  $F_T$ . We can argue that a linear relation exists also between the magnetic friction force and the drift velocity, so we can characterize the magnetic damping as due to a *viscous* friction force, that can be expressed as:

$$\vec{F}_{\text{Viscous Friction}} = -b \vec{v} = -m\beta \vec{v} \quad (1)$$

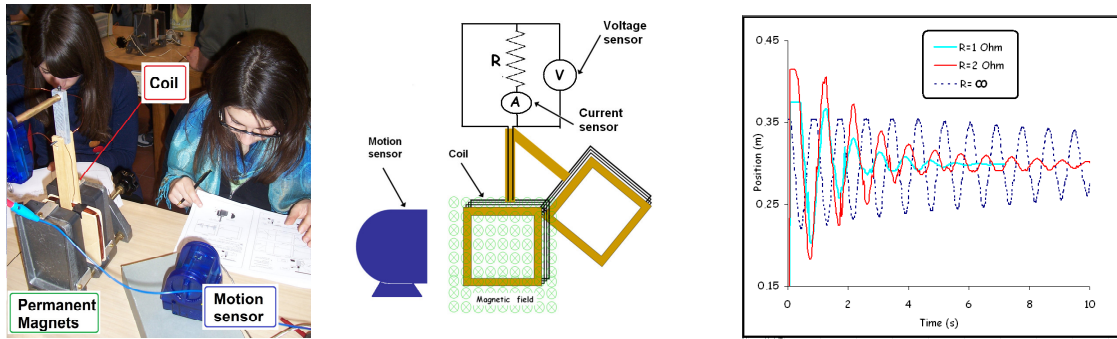


**Figure 2** - (Left) Position versus time plot obtained with a motion sensor. The presence of a “friction force” which causes a uniform motion is observable when the sheet is exiting from the magnetic field. (Right) Experimental values of the drift velocity of the conductor obtained for increasing values of the driving force  $F_T$ . Data are fitted by a linear relation according the rule  $v_d = F_T / (\beta m)$

### 3. The role of the ohmic resistance

To explore the energy transfer connected with the action of the magnetic braking force a different experimental apparatus is proposed. A metallic plate oscillates in the magnetic field produced by two permanent magnets. Students observe the strong damping of this *eddy current pendulum*, also known as *Waltenhofen's Pendulum*, and are requested to explain why does the mechanical energy decrease.

The role played by the intensity of the induced current in determining the damping of the pendulum is studied by substituting the aluminium plate with a coil oscillating in the magnetic field and connected to an external circuit whose resistance can be varied (see Figure 3, Middle). Motion and current/voltage sensors allow measure the amplitudes of the oscillations, the velocity of the *coil pendulum*, the electromotive force and the current induced in the coil. Graphs of position vs time are obtained in real time (Figure 3, Right).



**Figure 3** - *Experimental set up(Left) and its schematic representation(Middle). (Right) Graphs of position versus time for different values of the shunt resistance.*

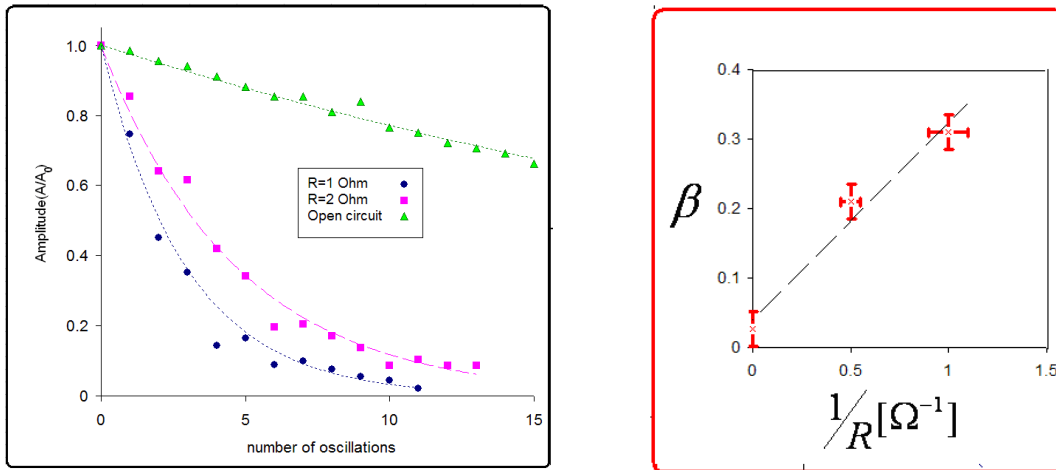
The role played by the resistance of the circuit (and then by the intensity of the induced current) in determining the damping of the oscillations of the coil pendulum, due to the magnetic friction force, is stressed. Students observe how the damping of the oscillations increases when the circuit resistance decreases. This is for most of the students an unexpected result.

If the students have already studied the motion of a harmonic oscillator damped by viscous friction forces it is possible to extend the analysis and find a relation between the viscous friction coefficient  $\beta$  and the shunt resistance  $R$ .

According to the theory, the angular position versus time of a pendulum, damped by a viscous friction force, is described by the equation  $\vartheta(t) = \vartheta_0 \exp[-\frac{\beta t}{2}] \cos(\omega t)$  where  $\omega = \sqrt{\omega_0^2 - \frac{\gamma^2}{4}}$  and  $\omega_0$  is the frequency of the un-damped oscillator. It follows that, in the hypotheses of small oscillation amplitude and friction force proportional to the velocity, the relation between the amplitude and the number  $n$ , of the accomplished oscillations is

$$\vartheta_n = \vartheta_0 \exp[-\lambda n] \text{ where } \lambda = \frac{\beta}{\omega} \pi = \frac{\beta}{2} T .$$

By using the graphs reported in Figure 3 students can find, for each value of the resistance, the amplitude of the oscillations at different time values and plot  $\vartheta_n$  versus  $n$ , (Figure 4, Left). The data are fitted by exponential curves and the damping factor  $\lambda$  is obtained for the three value of the resistance,  $R=1 \Omega$ ,  $R=2 \Omega$ ,  $R=\infty$  (open circuit).



**Figure 4** - The amplitudes of the oscillations of the magnet are reported as function of the number  $n$  of the accomplished oscillations for different values of the resistance  $R$  of the circuit (Left). Experimental values of the viscous friction coefficient are reported for different values of the resistance  $R$ . The data fit with the relation in eq.(2) (Right).

The plot in Fig. 4.Right shows how the experimental values fit with a relation

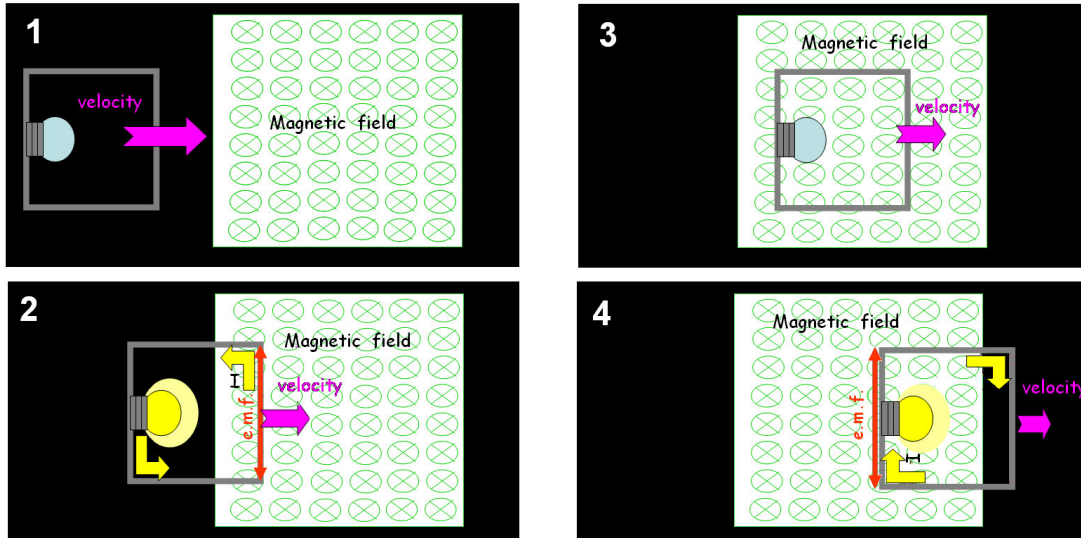
$$\beta = \beta_{\infty} + \frac{\kappa_0}{R}, \quad (2)$$

where  $\kappa_0$  is a constant while  $\beta_{\infty}$  includes the contribution to the damping of air resistance, sliding friction at the pivot etc. In this way students verify that the damping of the oscillations and the coefficient  $\beta$  increase when the circuit resistance decreases.

#### 4. The energy point of view

The energy point of view can be used not only to give a qualitative interpretation of the experimental results (the loss of the mechanical energy of the conductor can be explained with the increase of the internal energy of the circuit, where a resistive thermal conversion takes place), but also to derive a quantitative explanation. In particular, the theoretical relation between the resistance  $R$  and the magnetic friction coefficient  $\beta$  can be obtained and compared with the experimental results. At this aim we consider a simple system constituted by a wire loop which enters with velocity  $v$  into a region where a uniform magnetic field is present (Figure 5).





**Figure 5** - Schematic plot of a wire loop which enters in a uniform magnetic field with starting speed  $v$ . When the coil moves fully outside or fully inside the region where the magnetic field is present no current flows in the wire. When the coil is just partially inside the region with magnetic field, the magnetic flux changes and the induced emf produces a current flowing in the wire.

The wire has a mechanical energy proportional to  $v^2$ . When the magnetic flux through the surface bounded by the wire loop changes an electromotive force (emf) is produced along the closed path of the wire. Since the emf is proportional to the rate of change of the magnetic flux, according to the laws of the electromagnetic induction,

$$emf = -\frac{d\Phi(B,t)}{dt} = -BL\frac{dy}{dt} = BLv, \quad (3)$$

where  $L$  is the length of the wire side perpendicular to  $v$ . In the closed circuit with resistance  $R$  a current flows and an increase of the internal energy of the wire loop takes place at rate  $P_J = I^2 R = \frac{emf^2}{R}$ , corresponding to the power dissipated by the circuit. As a consequence the mechanical energy is reduced at the same rate:

$$P_J = \frac{emf^2}{R} = \frac{1}{R} \left( \frac{d\Phi(B)}{dt} \right)^2 = \frac{1}{R} \left( BL \frac{dy}{dt} \right)^2 = \frac{B^2 L^2}{R} v^2. \quad (4)$$

This corresponds to the work performed during a second by a force  $\vec{F}_{mf} = -M\beta \vec{v}$  with

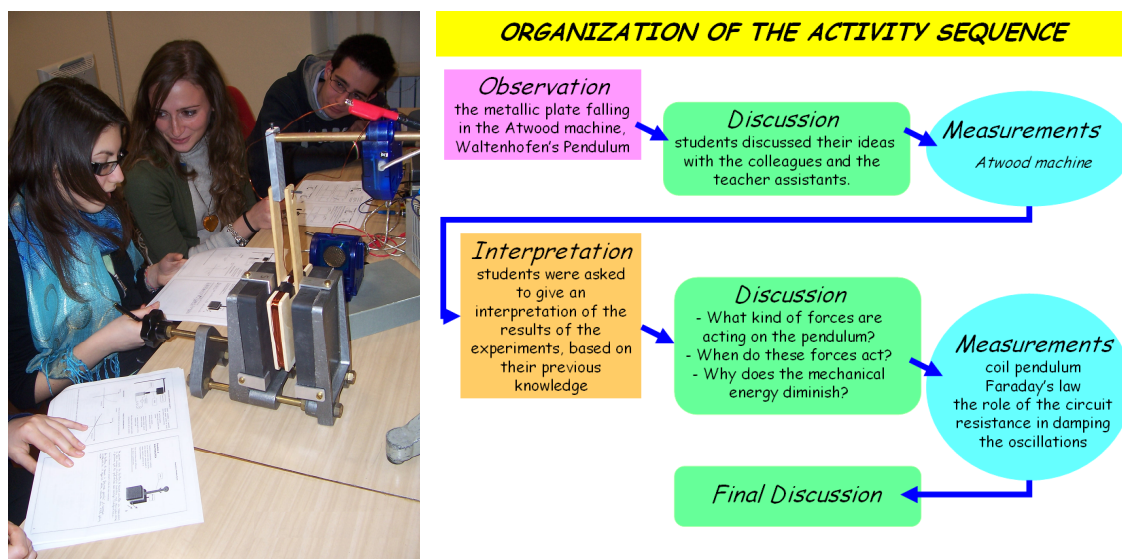
$$\beta = \frac{B^2 L^2}{MR} \quad (5).$$

In this way the phenomenological law expressed by equation (1) is obtained, together with the theoretical dependence of the viscous friction coefficient on the resistance. The experimental

results reported in Figure 4 and eq.(2), agree with the theoretical prediction given by equation (5).

## 5. Using the experiments with students

The experiments have been tested with high school students and with student teachers in a postgraduate course for physics teacher education. The students carried out the experimental activities in groups of four and *the activity sequence* was developed according to the phases reported in Fig.6. Asking questions and stimulating a discussion before and after each experiment encouraged the students to think critically and to maintain a high level of interest.



**Figure 6** - The students carried out the experimental activities in groups of four and completed the experimental work in a session of three-four hours. One or two assistants (generally master students) worked as facilitators. The organization of the activities: students spent a large portion of their laboratory time observing, interpreting and discussing the experimental results with their peers.

Data collected during students' activity show a progression of students' ideas during the development of the sequence

- The design of the experiment on the Atwood machine gave the students the possibility of easily distinguishing the three phases of the motion and perceiving when the magnetic force was active.
- Students recognized that the magnetic force has the same dependence on the velocity as a viscous friction force.
- The evidence of braking forces in the experiments revealed to be a strong motivation for students to investigate carefully and in a quantitative way the effects of electromagnetic induction.

By discussing students' interpretations during and after the activity sequence we found that:

- The majority of the students evoked generically Lenz's law by referring only to the magnetic field (without considering the induced currents). This way of using Lenz's law might cause a misleading interpretation of the magnetic force. Students who think that field lines are real lines which can interact with each other often consider the force

as produced by the interaction between two magnetic fields, the induced one and the one generated by the permanent magnets.[16]

- Some students identified the induced emf with the braking force, by interpreting the electromotive force as a real force.
- Other students (a minority) tried to give a description of the braking magnetic force only by using Lorentz' force. They attributed to the Lorentz' force the character of damping force, thus arriving to the paradoxical consequence of attributing to this force the possibility of doing work, neglecting the role of the electrical resistance.[17,18]
- Based on the well known relation  $W = I^2R$ , many students were initially convinced that the damping of the oscillations would increase with the resistance. They spontaneously did not recognize that the variation of the resistance produced a variation of the current and that this variation strongly affected the resistive dissipation. Discussion after the experiment allowed the majority of the students to reflect on this point and on the meaning of the relation  $W = I^2R$ .

We interviewed many of the students who participated in the laboratory activities asking them an evaluation of their experience. They especially emphasized as positive the opportunity of setting up by themselves the experimental apparatuses, doing the measurements and proposing alternative experiments. Students appreciated that the study of the magnetic force was based on the investigation of physical phenomena rather than on the manipulation of abstract formulas in a textbook.

Some of them also remarked *“These physical phenomena are quite impressive in fact we were always surprised about what really happened”*

Some students observed how a good experimental analysis requires many concepts usually learned in different moments of the scholar instruction. One student wrote *“the experiment is quite simple to be realized, because we used very common materials (magnets, coils, metallic sheets,...) but it is very hard to be understood. It was the most complex experience of our physics course”*. One other noted *“The explanation of the physical phenomena was quite difficult and we discussed several different proposals to explain what happened”*.

## References

- [1] Darren Wong, Paul Lee and See Kit Foong A datalogger demonstration of electromagnetic induction with a falling, oscillating and swinging magnet PHYSICS EDUCATION 45, 394 2010
- [2] Chabay R and Sherwood B 2006 Restructuring the introductory electricity and magnetism course Am. J. Phys. 74 329–35
- [3] Galili I and Kaplan D (1997) Changing approach to teaching electromagnetism in a conceptually oriented introductory physics course Am. J. Phys. 65 (7), 657-667.
- [4] Albe V, Venturini P and Lascours J (2001) Electromagnetic Concepts in Mathematical Representation of Physics, Journal of Science Education and Technology, 10 (2)
- [5] Bagno E and Eylon B S (1997) "From Problem Solving to a knowledge structure: An example from the domain of electromagnetism," Am. J. Phys. 65 (8) 726-736.
- [6] Thong W M and Gunstone R (2008) Some student beliefs about electromagnetic induction. Research in Science Education, Res. Sci. Educ. 38, 31-44.
- [7] Nicklin R C (1986) “Faraday’s Law—Qualitative Experiments,” Am. J. Phys. 54, 422–428.
- [8] Kingman R, Rowland S C, and Popescu S, (2002) An experimental observation of Faraday’s law of induction Am. J. Phys. 70 595-598.

- [9] MacLatchy C. S., Backman P., and Bogan L., (1993) “A quantitative magnetic braking experiment,” *Am. J. Phys.* 61, 1096–1101.
- [10] Carpena P., (1997) “Velocity measurements through magnetic induction,” *Am. J. Phys.* 65, 135–140.
- [11] L. H. Cadwell, “Magnetic damping: Analysis of an eddy current brake using an airtrack,” *Am. J. Phys.* 64, 917-923 (1996).
- [12] X. Xie, Z. Wang, P. Gu, Z. Jian, X. Chen, and Z. Xie., “Investigation of magnetic damping on an air track,” *Am. J. Phys.* 74, 974-978 (2006).
- [13]A. Vidaurre, J. Riera, J. A Monsoriu and M. H Gimenez, “Testing theoretical models of magnetic damping using an air track,” *Eur. J. Phys.* 29, 335–343 (2008).
- [14]A. Bonanno, G. Bozzo, M. Camarca and P. Sapia, “Foucault dissipation in a rolling cylinder: a webcam quantitative study,” *Eur. J. Phys.* 32, 419-429 (2011).
- [15] [www.pasco.com](http://www.pasco.com)
- [16] J. Guisasola, J. M. Almudí, and K.Zuza, “The design and evaluation of an instructional sequence on Ampere’s law,” *Am. J. Phys.* 78, 1207-1217 (2010).
- [17] E. P. Mosca, “Magnetic forces doing work?,” *Am. J. Phys.* 42, 295-297 (1974).
- [18]J. A. Redinz, “Forces and work on a wire in a magnetic field,” *Am. J. Phys.* 79, 774-776 (2011).

# Two simple ways of verification of the $1/r^2$ dependence in Coulomb's law at both high school and university level

Zdeněk Šabatka, Leoš Dvořák

Department of Physics Education, Faculty of Mathematics and Physics, Charles University in Prague, V Holešovičkách 2, 180 00 Prague 8, Czech Republic

E-mail: [sabatka@kdf.mff.cuni.cz](mailto:sabatka@kdf.mff.cuni.cz), [leos.dvorak@mff.cuni.cz](mailto:leos.dvorak@mff.cuni.cz)

## Abstract

This article describes two simple and inexpensive ways how to demonstrate and to verify the Coulomb's law. The first part presents the classical way of Coulomb's law demonstration (using two charged balls). But the most precise experiments performed in the 20<sup>th</sup> century utilize the equivalence of  $1/r^2$  dependence and the fact that the electric field inside a charged conductive sphere is zero. In the second part we present low-cost variant of such experiment using simple home-made detector of electric field with FET transistor.

## Introduction

Coulomb's law is usually the first formula learned by students in the area of electrostatics at both high school and university level. High school students are familiarized with its scalar form

$$F_e = \frac{1}{4\pi\epsilon} \cdot \frac{Q_1 Q_2}{r^2}, \quad (1)$$

where  $Q_1, Q_2$  are charges of particles,  $\epsilon$  is the permittivity of dielectric media surrounding the particles and  $r$  is a distance between those particles. One has to add that the positive force implies a repulsive interaction and a negative force implies an attraction.

But quite often this formula is just stated, perhaps referring briefly to historical measurements using torsion balance, without any quantitative demonstration or lab. The natural question can be raised by students whether the exponent is really 2 and not, say, 1.99 or 2.01. We think that only a small number of even good physics teachers is able to show to students some experimental proof. We will present two methods how to do it.

## The direct method

The main principle of the verification using the direct method is that one has to somehow determine a magnitude of the acting force. To do it one may use torsion balance, in the same way as Coulomb did<sup>1</sup> or a simple scales, as it is described in [2]. However, our experiment was inspired mainly by [3] where the author used electronic scales.

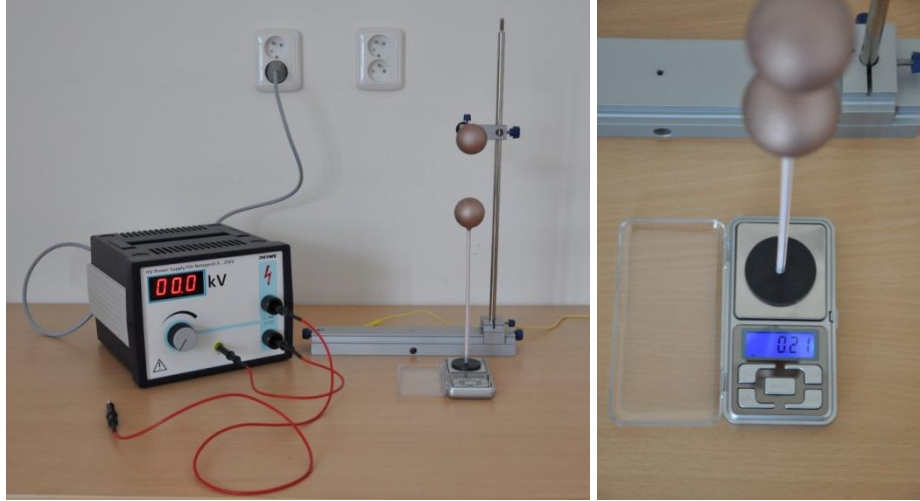
We present the variant of such experiment enabling rather simple and fast measurement we developed for our new Interactive Physics Laboratory for high school students. The project of this Lab was described in a short talk at GIREP 2009 [4]. We will also use it as a demonstration kit in lectures for future physics teachers.

## *Apparatus and method of measurement*

The apparatus (see fig 1a) consists of an electronic scales, three conductive balls, a high voltage power source, cables, an adjustable stand and a ruler.

---

<sup>1</sup> How to do this historical experiments was described e.g. in [1].



**Figure 1** a) Apparatus for demonstration and verification of the Coulomb's law.  
b) "Weighting" the electric force.

The conductive balls were made from ping-pong balls (approx. 4 cm in diameter) sprayed with copper-based conductive coating<sup>2</sup>, which is intended to shield from electromagnetic waves. One can also use other methods how to make the balls conductive, e.g. coat it using powder made out of a black lead. Each of those balls is fixed to a straw which makes together with a small plastic slab a stand of the ball.

To verify the dependence  $F_e(r)$  one could charge both balls with the same charge and then while changing their relative distance observe the changing force acting between them. Balls could be charged by a high voltage power source (we used controlled power source up to 25kV). The electric force is detected using the electronic scales on which one of balls is placed (see fig 1b).

The scales should have resolution at least 0,01g. Of course, more is better. But data below were really gathered using the scales with such resolution. Almost every scales has a function 'tare' which allows you to "weigh" only the electric force between charged balls – the added weight matches the electric force. Students will get the force just by multiplying the number on the scales by the factor  $g^3$ .

### Correction

There is one problem which was not yet mentioned, and which could do troubles to students. Coulomb law is valid for pint charged particles (or homogenously charged spheres). But as everyone can see our balls are not point like. Moreover, especially when they are close to each other, the charge distribution would not be uniform on their surfaces. Therefore the force they repel would differ from the value given by the formula (1).

So we have to use corrections to (1). The corrected formula looks a bit unfamiliarly:

$$F'_e = \frac{Q^2}{4\pi\epsilon_0 r^2} \left[ 1 - 4\left(\frac{a}{r}\right)^3 + 14\left(\frac{a}{r}\right)^6 - \dots \right]. \quad (2)$$

<sup>2</sup> To be concrete we have used EMILAC. See [5] to get further information about it.

<sup>3</sup>  $g$  is standard gravity. In fact almost every scales with such resolution shows the weight in grams, so be aware of units. If you multiply the number on the scales by  $g$  you will get the force in milinewtons.

Here  $a$  is a radius of each charged sphere (in our case the ping-pong ball) and the rest is same as in a common version of Coulomb's law (1). The derivation of this formula can be found in [1].

In our case the term  $14\left(\frac{a}{r}\right)^6$  and the following ones are so small that they could be neglected.

The final relation looks a bit simpler:

$$F'_e = \frac{Q^2}{4\pi\epsilon_0 r^2} \left[ 1 - 4\left(\frac{a}{r}\right)^3 \right] \quad (3)$$

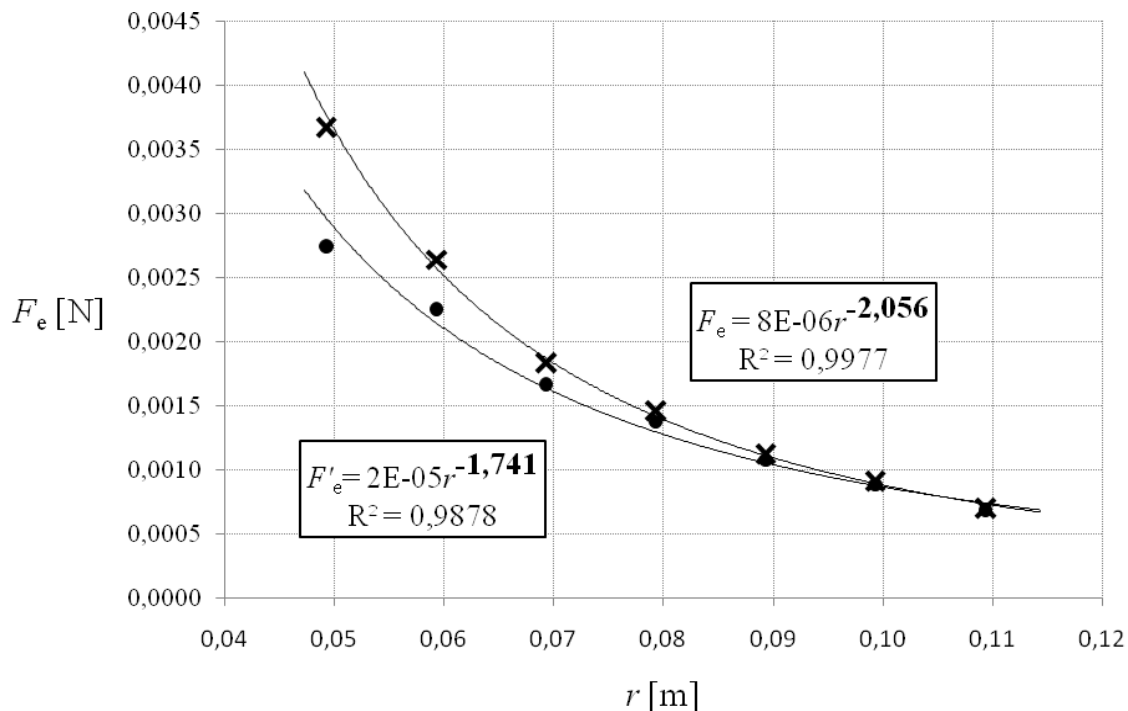
How to verify relation (3) using e.g. MS Excel? (Note that Excel is able to fit only built in functions.) So, one has to transform the equation (3) to

$$F_e = \frac{F'_e}{\left[ 1 - 4\left(\frac{a}{r}\right)^3 \right]} = \frac{Q^2}{4\pi\epsilon_0 r^2}, \quad (4)$$

where  $F_e$  is now a "corrected force" with correction – the force which would be measured if the charges would be point like.

### Results

An example of one measurement is shown in the graph 1. To show how important it is to do the correction we have added also the dependence without the correction mentioned above.



**Graph 1** Comparison of the really measured force  $F'_e$  (●) and the force with correction  $F_e$  (×).

Looking at the graph and also other experimentally determined exponents (-2.026, -1.937, -2.071, -2.001) we may say that we have proved the dependence  $1/r^2$  in Coulomb's law. There



is of course some inaccuracy of our measurement. Because we measure at maximum about 0.20g with sensitivity 0.01g, we can estimate the overall uncertainty to be of the order of  $(0.01/0.20) \cdot 100\% = 5\%$ .

### Cavendish type experiment

Yet, student measurements using charged spheres cannot aspire to high precision and should be considered rather as rough estimates of the exponent in Coulomb's law. The most precise experiments performed in the 20<sup>th</sup> century utilize the equivalence of  $1/r^2$  dependence and the fact that the electric field inside a charged conductive sphere is zero. The quantitative analysis of such measurement fits to introductory university course (e.g. for future physics teachers), the simplified reasoning can be presented also at high school level.

#### Idea

As mentioned above our new goal is to proof that inside a charged Faraday's cage there is no electric field. That's the fact which directly results from the Coulomb's law.

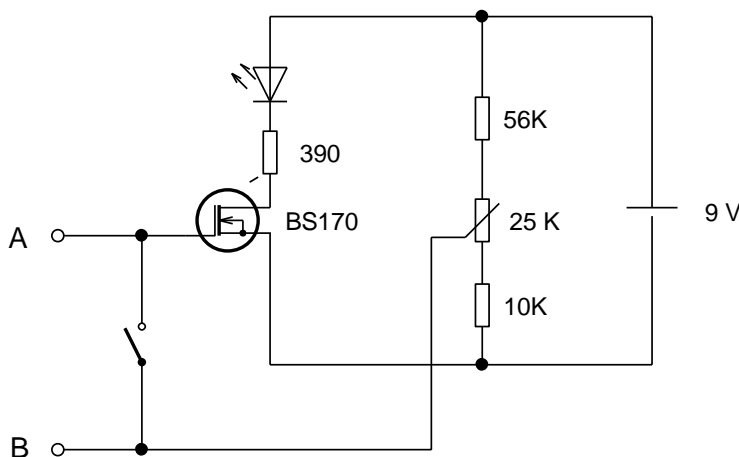
Let's assume that the electric force does not vary as  $1/r^2$ , but as  $1/r^{2+\epsilon}$ . Then we are able to calculate that in a spherically symmetric case the difference between electric potentials on the surface ( $\phi_{in}$ ) of the cage and inside ( $\phi_0$ ) is about

$$\phi_{in} - \phi_0 \doteq -0.2 \cdot \epsilon \cdot \phi_0 \quad (5)$$

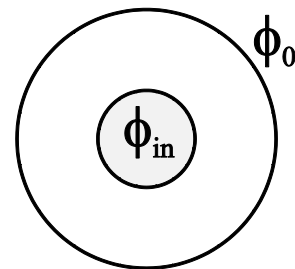
(The derivation of (5) is, in fact, not harder than some end of chapter textbook tasks; we will present it elsewhere.)

#### The indicator

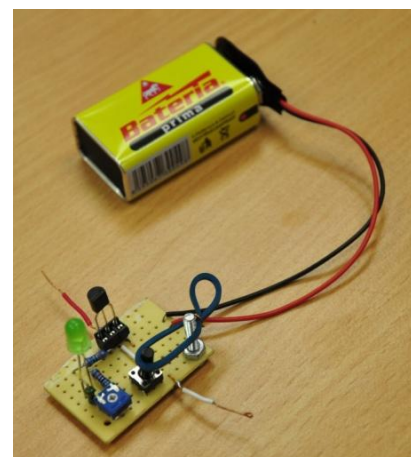
To measure the difference of potentials we need some meter or indicator. We have built one (see fig 3) using a FET (field-effect transistor). To indicate that there is some potential between contacts A and B we use a green light emitting diode – the brightness of the diode indicates the voltage between A and B. When A and B are connected we set the brightness of the LED to some intermediate level using the potentiometer. The non-zero voltage between A and B is indicated by change of the brightness of the LED. We proved during testing that the sensitivity of our indicator is better than 50mV.



**Figure 3** Home-made indicator of electric field with FET. **a)** Circuit diagram  
**b)** The real indicator



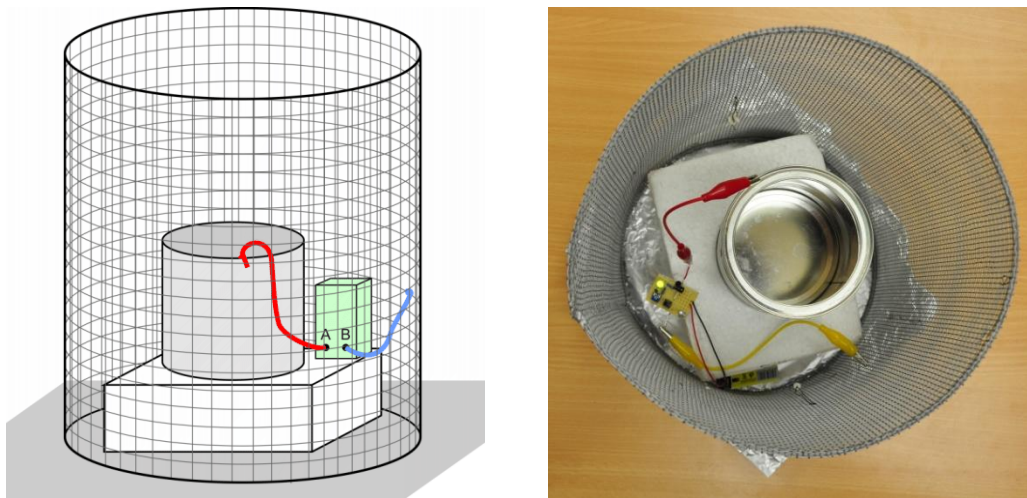
**Figure 2** Potentials inside and on the Faraday's cage.





### Experimental setup

We have placed the indicator including its power source (9V battery) inside a Faraday's cage and attached one of contacts to the cage and other one to a can placed also inside the cage on a piece of Styrofoam (see fig 4).



**Figure 4** Experimental setup

### Results and accuracy

We started our experiments with a Faraday's cage with many holes (see figure 4). We found out that our indicator in such cage reacts also to a charged rod outside the cage. Evidently the field could “enter” into such not so perfect Faraday's cage. So we decided to cover the cage step by step. For covering we used aluminium foil. We connected the cage to the high voltage source (25kV) and watched the indicator's LED inside the cage. For “partly opened cage” the LED still changed its brightness, so we made the hole smaller and smaller. Finally we were successful and made the cage (see fig 5) inside which was the electric field smaller then the indicator was able to detect (the potential difference was certainly smaller then 50mV).



**Figure 5** The Faraday's cage in which no electric field was<sup>4</sup>.

- a) The cage connected to high voltage source
- b) A small hole in the cage through which we observed the indicator.

So we have proved that there is no electric field in a good Faraday's cage. Therefore we can conclude that the dependence of electrostatic force between point charges is really  $1/r^2$ .

<sup>4</sup> There is probably some electric field, but it is below the sensitivity of our indicator.

What is the accuracy of our statement? We have assumed that the dependence of force on distance is  $1/r^{2+\varepsilon}$ . In this case the difference of electric potential would be approximately  $\phi_{in} - \phi_0 \doteq -0.2 \cdot \varepsilon \cdot \phi_0$ . In our experiment the difference  $|\phi_{in} - \phi_0| \leq 50 \text{ mV}$ . The potential of the outer part of the cage was  $\phi_0 = 25 \text{ kV}$ . We are able to estimate the value of  $\varepsilon$  as

$$|\varepsilon| = 5 \cdot \frac{|\phi_0 - \phi_{in}|}{\phi_0} < 5 \cdot \frac{50 \cdot 10^{-3}}{25 \cdot 10^3} = 10^{-5}. \quad (6)$$

So the inaccuracy of our statement that in Coulomb's law is the dependence  $1/r^2$  is less than  $10^{-5}$ . Looking at table 1 one could find out that accuracy of our experiment is five times better than that obtained by J.C. Maxwell's and much better than that of Cavendish's experiment. Of course, the 20<sup>th</sup> century experiments are orders of magnitude more precise than our experiment described above – but they are not small enough and cheap enough to be used in schools.

Experimenters	Year	Accuracy
H. Cavendish	1772	$ \varepsilon  < 0.02$
J. C. Maxwell	~1872	$ \varepsilon  < 5 \cdot 10^{-5}$
Plimpton and Lawton	1936	$ \varepsilon  < 2 \cdot 10^{-10}$
Williams, Faller, Hill	1971	$ \varepsilon  < (2.7 \pm 3.1) \cdot 10^{-16}$

**Table 1** The accuracy of historical experiments confirming the dependence  $1/r^2$  in the Coulomb's law [6]

## Conclusions

The main point of our contribution was to show that even at high school it is not so big problem to do experiments proving fundamental laws of physics, e.g. Coulomb's law. Of course we were focused only on one concrete part of Coulomb's law. But one can also show the dependence of electric force on charge or on its surroundings (permittivity).

Experiments presented in this article will be used as demonstration experiments at the lecture on Classical Electrodynamics for future physics teachers and also in our Interactive Physics Laboratory for high school students.

The work described in this article was supported by grant FRVŠ 1237/2010/G6 of Czech Ministry of Education, Youth and Sports.

## References

- [1] Martínez, Alberto A. 2006 Replication of Coulomb's Torsion Balance Experiment *Archive for History of Exact Sciences* **60** [517-563](#)
- [2] Larson C O and Goss E W 1970 A Coulomb's Law Balance Suitable for Physics Majors and Non-science Students *Am. J. Phys.* **38** [1349-1352](#)
- [3] Cortel A 1999 Demonstrations of Coulomb's Law with an Electronic Balance *Phys. Teach.* **37** [447-448](#)
- [4] Zdeněk Šabatka, Zdeněk Drozd and Leoš Dvořák, Activities for high school students: from demonstration experiments to an interactive laboratory, GIREP-EPEC, Oral Sessions – Experiments, Leicester, 2009
- [5] Produktdetails – Lacquers – EMILAC [cit. 2010-10-13] [http://itwcp.de/contentcenter/content.php?action=details&rubrikid=496&ID=383&template=detail\\_tpl\\_produkte\\_en.html](http://itwcp.de/contentcenter/content.php?action=details&rubrikid=496&ID=383&template=detail_tpl_produkte_en.html)
- [6] Jackson J D 1998 *Classical Electrodynamics* ISBN 978-0471309321

# **Experiments in Schools and Science Labs**

An Explicit “Nature of Science”-Aspect in a Project for a Science Lab for School Students

**Stefan Uhlmann, Burkhard Priemer**

Ruhr-University Bochum, Faculty of Physics and Astronomy  
Physics Education  
Universitätsstraße 150, 44801 Bochum, Germany  
uhlmann@physik.rub.de, priemer@physik.rub.de

## **1. Introduction**

In Anglo-American research, pupils’ and students’ views about the Nature of Science (NoS) have been a well-known issue over the last decades (review e.g. in Lederman 2007). However, this is not the case in German speaking countries. Since the moderate results of international comparative studies (e.g. TIMSS III) have certified German pupils’ inadequate views about the NoS, more attention is paid on this research topic (e.g. Höttecke 2001, Priemer 2003). According to Lederman (2007) and others, adequate views about NoS have an impact on content learning success. Despite this, NoS seldom is - especially in Germany - a topic in our curriculum and therefore it is not addressed in classroom instruction. This article shows, how a project explicitly addressing NoS as well as Physics contents in a science lab for school students can change this. This new approach is a first attempt to show that it is possible to change pupils’ views about NoS with a relatively short but explicit instruction. From our point of view, an explicit and well-dimensioned NoS-focus can lead to more adequate views concerning NoS aspects.

## **2. Science laboratories for school students in Germany (“Schülerlabore”)**

Besides science centers, museums, and field trips, a new type of informal learning facilities has been established throughout Germany: extracurricular science laboratories for school students. In these labs, school students usually participate in one-day science projects, which are more formal than visits to museums or science centers, but which are still informal in comparison to school instruction. These forms of student-centered science labs offer a high potential of supporting science education. Founded and run by universities and other research institutions, these science labs aim a. at supporting schools in teaching modern science topics and concepts, b. at increasing students’ interests in science, and c. at attracting future university students in science and engineering domains (Guderian & Priemer, 2008; Priemer, 2008; Priemer, 2006).

## **3. Nature of Science (NoS) in science laboratories for school students**

The umbrella association of German science labs for school students “LeLa – Lernort Labor” has, in spite of the strong differences in the conception of the different science laboratories, developed common aims. One of those aims, for example, is the teaching of an up to date image of sciences and technology and their importance for our society (Euler 2005, translated by the authors). Apart from this, keywords falling into the area of Nature of Science can also be found used by the operators of science labs themselves.

Many science labs for school students also follow more or less explicitly the aim of positively influencing pupils' views about NoS and therefore also of 'improving' young peoples' views about sciences, which are often inadequate (e.g. Lederman 2007). Thereby, authentic learning environments of field trips are often believed to transport adequate epistemological beliefs more or less "automatically". However, studies allow the conclusion that adequate beliefs about the NoS cannot be conveyed without being made an explicit topic of discussion (Lederman 2006, Uhlmann & Priemer 2009). We are of the opinion that if you make NoS-aspects an explicit topic of discussion, you will have the chance of establishing more adequate epistemological beliefs. The basic questions, namely if and how Science Labs can reach the above-mentioned aims concerning NoS, were the beginning of the here presented project. The project can be labeled with the following three keywords: "explicit" "authentic" and "reflexive". In the following chapters, those three keywords will be examined in detail.

#### 4. The design of the NoS-project

The project has two focuses. One focus lies on plasma physics, more precisely on the physics of plasma spheres and the spectroscopy of the contained gases. Apart from this very important focus on plasma physics, there also is an equivalent epistemological emphasis in this project. Here, the differences of experiments carried out at schools and scientific experiments as well as the pupils' beliefs about scientific experiments and scientists are examined. To be able to change their beliefs, the educational objectives have to be well-dimensioned. This essentially means that "only" parts of the huge NoS-field – as well as of the physics field – can be made a topic of discussion. In the following, the schedule of the project is introduced in detail. The project was designed for pupils at the age of 16-18 years and takes about six hours.

##### 4.1. Introduction to the principles of plasma physics

Plasma is not a topic occurring in the physics curriculum in Germany. Therefore there is a short presentation introducing the pupils to the "world of plasma" at the beginning of the project. With the help of simple models and explanations, among others, the following questions are answered: "What is plasma in physics?", "Why does plasma emit light?", "How can one identify the gas of plasma?", "How does the plasma sphere work?". Why does it actually make sense to concern oneself with plasma? The introduction motivates by talking about occurrence and application of plasma in nature and technology. As the pupils are supposed to spectroscope plasma independently in the next phase of the project, also the principals of prism spectroscopy are introduced (refraction, dispersion, direct-vision prism, spectroscope).

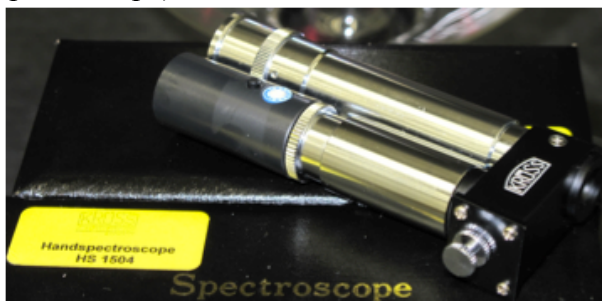


Figure 1 spectroscope

identify the filling gases of a commercially available plasma sphere. For this purpose, the authors developed a detailed list of instructions, which the participants of the project have to follow (see Uhlmann & Priemer 2011). With the help of a hand-held spectroscope (see figure 1) the pupils are supposed to identify the spectrum lines of the plasma sphere.

##### 4.2 Spectroscopy of the filling gases of a plasma sphere

For explicitly contrasting the differences between "typical" school experiments and scientific experiments, the pupils are encouraged to conduct an experiment which methodology was designed similar to experiments at schools. The task is to

### 4.3 Introduction to the Nature of Science focus of the project

A lot of pupils are unfamiliar with the topic Nature of Science. For this reason, a short presentation introduces them to the most important principals of the Nature of Science and informs them about the basic questions thought about in this meta-physical area. It is, for example, explained that this field is not primarily concerned with physical facts and knowledge, but rather with how knowledge is gained in science. The advisor introduces the following discussion by stating provocative theses. Among others, the following fields are made a topic of discussion:

- *whether the same experiment can lead to identical results if it is carried out at two different places (and therefore by different scientists with other scientific backgrounds, such as religion, investors, etc.),*
- *whether the data evaluation of a scientific experiment is always objective,*
- *how long scientific experiments take,*
- *where there could be differences between scientific experiments and experiments at schools,*
- *whether scientists work alone,*
- *how scientific experiments are financed, etc.*



Figure 2 NoS categories

The organigram in figure 2 shows further categories of this introductory discussion. This organigram is very important, as it reflects the most important NoS contents addressed in this project. In this phase, the pupils reflect on their views about the NoS focus for the first time. The aim of this discussion is preparing the pupils for the next phase in which they interview physicists as well as discuss the scientific gaining of knowledge with their class. The views



mentioned by the pupils are used in a later phase of the project again, when they are contrasted with the beliefs of scientists.

#### 4.4 Development of interviews

In this phase, the pupils are separated into six groups. Each group gets four categories of figure 2 and the task to develop questions concerning their categories, which they would like to ask the plasma physics experts of the faculty later on. This group work aims at the conception of a 20 minutes long interview with a focus on epistemology.

#### 4.5 Expert interviews and guided laboratory tours

In this phase of the project, the authentic surroundings of the science lab for school students are used explicitly. The participants leave the science lab in groups and contact plasma physics experts of the faculty. None of the experts is instructed before the interviews. The aim of those tours is showing authentic scientific experiments to the pupils (see figure 3). Authenticity, one of the keywords of this project, is ensured in this phase.

#### 4.6 Collecting the results

As each group has different categories and therefore also different questions, the groups get the chance of preparing for a short presentation about their results and impressions (questions, the experts' answers, laboratory experiences, etc.) for their classmates after the interviews and the guided laboratory tours.

#### 4.7 Reflection of the impressions

After the short presentations, the adviser again initiates a discussion. Here, once more, the reflexive character of the project is highlighted. After having gathered and reflected on the scientists' views and beliefs, the results are contrasted with the pupils' views and beliefs before and after the authentic impressions. The aim here is finding differences. There is a great emphasis on the comparison of those three positions, as this is, in our opinion, a very important reflection on the learning targets in the epistemological area. The adviser explicitly does not try to find a consensus concerning the mostly different beliefs and he/she also does not try to establish "the" adequate (or even "right") belief, but he/she does discuss the differences and the fact that one cannot establish an adequate understanding and that this is a special characteristic of NoS.

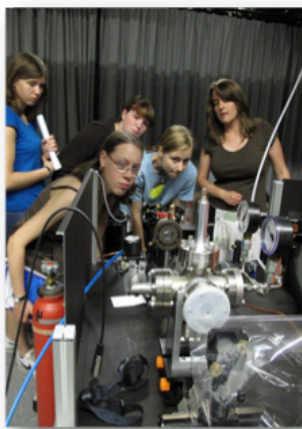


Figure 3 pupils in the guided lab tours

## 5. Experiences from the project and results of the survey

It is worth mentioning that the pupils were generally very enthusiastic about NoS as a topic in a science lab. The active participation in the discussions as well as the engaged and creative contributions concerning the development and performance of the expert interviews show this. The participants were able to very quickly familiarize themselves with the epistemological topic.

Concerning some aspects, they already had adequate beliefs. For instance, the pupils did not believe in the myth about the "lonely scientist" even before the project had started. The participants knew that scientists organize themselves in "scientific communities" to be more

effective in their work. Adequate views also occurred in socio-cultural questions. Here the majority of the pupils for example believed that the development of scientific experiments is independent from the country the scientist lives in, the language he speaks, the religion he believes in, et cetera. Moreover, an above-average amount of pupils stated that even scientists doubt their experimental results.

The participants' views concerning most aspects were, however, rather inadequate. The duration of scientific experiments, for instance, was evaluated in a too unreflected way. Common durations, like in school experiments, for instance, of 45 minutes were often mentioned. Before the project, the participants obviously did not differentiate between "typical" experiments at school and scientific experiments. Apart from that the pupils seem to predominantly think that experiments always refer to hypotheses, pure explorative phases are rather unknown. Furthermore and in conformity with other surveys (e.g. Aikenhead, 1987; Driver, Leach, Millar & Scott, 1996; Edmondson & Novak, 1993), evidence of naive realistic beliefs was found. The majority of the pupils for example believed that experiments are able to unveil the truth about nature and that scientific experiments are able to prove a theory. Furthermore, some participants also showed an inconsistent answering behavior concerning some parts of the topic. The pupils are, on the one hand, aware of the fact that even in scientific experiments measurement errors can occur, but they, on the other hand, also think that one can avoid measurement errors if one only measures accurately enough.

The scientists as well as the authors of this article realized (when reviewing the videos of the interviews) that the pupils asked profound and well thought through questions (compare examples in table 1). The pupils also showed a great interest in working on the physical focus. The high relevance of this physical topic in every day context as well as the enthusiasm of the scientists made a special impression on the pupils.

Table 1: Questions students asked Plasma-Physics experts in the interviews:

- "Can an experiment generate 100 percent results and can established laws be valid for ever?"
- "So you would say that established laws were questioned again and then were falsified later on?"
- "What does a scientist do?"
- "Are results and experiments similar, so to say international? Does the result depend on the cultural background or the origin of the scientist?"
- "Does it happen that wrong conclusions are drawn from results which count as true then?"
- "How important are political decisions?"
- "If you compare those experiments to school experiments, in how far does the equipment differ?"

The introduced project is part of a survey. In a pre-post-follow-up-design the general research interest is showing that it is possible to convey sub-dimensions of NoS aspects in relatively

short instructions in combination with physics contents in a science lab by making them an explicit topic of discussion. More than 200 pupils participated in an exploratory study at the Ruhr-University Bochum, Germany.

The results show that it is possible to change pupils' views about NoS in relatively short interventions (about 6h project) as long as the NoS-focus is well-dimensioned and made an explicit topic of discussion. Furthermore, the study revealed the conclusion that the additional focus in the field of NoS (together with the content focus) does not mean that the pupils do not learn physics contents.

## **6. Conclusion and implication**

The aim of the presented approach was to show that it is possible to change pupils' views about the NoS concerning a special focus (beliefs about the "nature of experiments") in a one-day project. The experiences from this project as well as the mentioned empirical evaluation survey showed that pupils' views can be positively influenced by making NoS aspects an explicit topic of discussion. In our opinion, a relatively small NoS focus is very important. We also believe that different NoS aspects require different methods. Therefore the interviews with scientists and the guided laboratory tours, which are part of this project, are not a necessary prerequisite of teaching other NoS topics. One could also try, for example, to achieve authenticity by using (historical) original sources such as articles or videos of physicists. This is especially important for schools lacking the possibility of using scientific research facilities.

The project is meant as a first step. Next steps are transferring this attempt to school by developing more projects with different NoS-aspects and evaluating the efficiency of authentic and explicit NoS-projects at schools. From our point of view, making different NoS-aspects a frequent explicit topic of discussion can lead to more adequate epistemological beliefs in a long run.

## **7. Literature**

- Aikenhead, G. S. (1987). High-School Graduates' Beliefs About Science-Technology-Society. III Characteristics and Limitations of Scientific Knowledge. *Science Education*, 71, 459-487.
- Baumert, J., Lehmann, R. & Lehrke, M. et al. (1998). Testaufgaben Naturwissenschaften TIMSS 7./8. Klasse (Population 2). Berlin: Max-Planck-Institut für Bildungsforschung
- Driver, R., Leach, J., Millar, R. & Scott, P. (1996). *Young People's Images of Science*. Buckingham: Open University Press.
- Edmondson, K. M. & Novak, J. D. (1993). The Interplay of Scientific Epistemological Views, Learning Strategies, and Attitudes of College Students. *Journal of Research in Science Teaching* 30 (6). 547-559
- Euler, M. (2005). Schülerinnen und Schüler als Forscher: Informelles Lernen im Schülerlabor. *Naturwissenschaften im Unterricht Physik*, 90, 4-12.
- Guderian, P. & Priemer, B. (2008). The impact of multiple visits to an informal learning facility on the development of interest in science. In P. J. Gilmer, C. M. Czerniak, J. Osborne, & W. C. Kyle (Eds.), *National Association for Research in Science Teaching, Annual Conference 2007, Baltimore, Impact of Science Education Research on Public Policy*, CD-ROM
- Halloun, I. (2001). *Student Views about Science: A Comparative Survey*. Beirut, Libanon
- Höttecke, D. (2001). Die Vorstellung von Schülern und Schülerinnen von der „Natur der Naturwissenschaft“. *Zeitschrift für Didaktik der Naturwissenschaften* 7. 7-23



- Lederman, N.G. (2006). Syntax of Nature of Science within Inquiry and Science Instruction. In N.G. Lederman, L.B. Flick . Science Inquiry and Nature of Science. (p. 301-317), Dordrecht: Springer
- Lederman, N.G. (2007). Nature of Science: Past, Present, and Future. In N.G. Lederman, S.K. Abell. Handbook of Research in Science Education (p. 831-879), Mahwah (N.J.,USA): Lawrence Erlbaum Associates, Inc., Publishers
- Priemer, B. (2003). Ein diagnostischer Test zu Schüleransichten über Physik und Lernen von Physik – eine deutsche Version des Tests „Views About Science Survey“. In Zeitschrift für Didaktik der Naturwissenschaften (p. 160-178),
- Priemer, B. (2006). Open Ended Experiments about Wind Energy. In E. v. d. Berg, D. v. d. Berg & T. Ellermeijer (Eds.). Group International de Recherche sur l'Enseignement de la Physique (GIREP), Conference 2006 "Modelling in Physics and Physics Education", Amsterdam, Book of Abstracts (p. 77). Ljubljana: GIREP.
- Priemer, B. (2008). Extracurricular Science Laboratories: an innovative informal learning facility for school students. In proceeding of Groupe International de Recherche sur l'Enseignement de la Physique (GIREP), Conference 2008 "Physics Curriculum Design, Development and Validation", Nicosia, Book of Abstracts (p. 66-67). Ljubljana: GIREP.
- Uhlmann, S. & Priemer, B. (2008). Können Schülerlabore Ansichten über Naturwissenschaften ändern? In D. Höttecke (Hrsg.), Gesellschaft für Didaktik der Chemie und Physik, Jahrestagung in Essen 2007, Naturwissenschaftlicher Unterricht im internationalen Vergleich. Münster: Lit Verlag.
- Uhlmann, S. & Priemer, B. (2009). Nature of Science und Plasmaphysik gemeinsam in einem Schülerlaborprojekt In D. Höttecke (Eds.), Gesellschaft für Didaktik der Chemie und Physik, Jahrestagung in Schwäbisch Gmünd 2008, Münster: Lit Verlag
- Uhlmann, S., Priemer, B. (2011). Das Experiment in Schule und Wissenschaft; ein „Nature of Science“-Aspekt explizit in einem Projekt im Schülerlabor, Proceedings DPG Conference 2010, <http://www.phydid.de/index.php/phydid-b/> (10/2010).

# Motivational Effectiveness of Experiments in Physics Education

Josef Trna, Petr Novak  
Masaryk University, Faculty of Education,  
Brno, Czech Republic  
[trna@ped.muni.cz](mailto:trna@ped.muni.cz)

## Abstract:

*Physics school experiments play a crucial role in motivation of students. That is why innovation in physics education leads to the accent on physics school experiments. This study verifies the motivational significance of experiments in physics and in science education. The importance of experiments in physics education is investigated, with a focus on the different educational roles of the experiments. Our research findings illustrate the fact that experiments used by physics teachers are not always appropriate and sufficient for development of students' physics knowledge and skills. We used the method of video-study, which is based on the analysis of video records of physics lessons. Different kinds of physics motivational teaching techniques can be based on observation and experimentation. From the pedagogical constructivist point of view it is important to select appropriate physics school experiments. Combinations of motivational teaching techniques result in an upgrading of students' motivation for physics education. Concrete examples of these cognitive motivational teaching techniques such as simple experiments, application of experiments in everyday life, entertainment-edutainment experiments, family physics experiments, experiments supported by ICT, action research based on experiments etc. are presented. All physics motivational teaching techniques presented here are based on experiments and are verified by our empirical research and practical school experiences. Results of our research should be inserted into physics teacher training. Validation and dissemination of our findings are supported by international projects as EUSTD-web and MOSEM.*

## 1 Introduction

An experiment is the most important educational and motivational tool in physics education. Every educational activity based on physics experiments can be a strong motivational stimulus. Physics teachers are often interested in creation of school experiments. But they usually do not think about the concrete implementation of the experiments in teaching and learning physics. A use of the wrong teaching method with an experiment results in a loss of educational objectives including motivation. We try to solve whether this statement is true or false:

*Physics school experiments play a crucial role in motivation of students in physics education.*  
This study tries to verify the motivational significance of experiments in physics education.

## 2 Cognitive motivational teaching techniques in physics education

We discovered two sets of cognitive motivational teaching techniques in physics education by the use of a factor analysis (Trna & Trnová, 2006):

*Physics cognitive motivational teaching techniques:*

- Stimulation through unconscious perception and experimentation
- Use of models of natural objects and phenomena
- Solving problem tasks and projects
- Demonstrating simple experiments and toys
- Seeing paradoxes and tricks
- Watching films, video programs and using computers (ICT)
- Experiencing humour in physics

*Interdisciplinary cognitive motivational teaching techniques:*

- Use “Physics for life” (energy, environment etc.)
- Application of physics knowledge in technology
- Exploitation of history related to physics discoveries and physicists' lives
- Reading sci-fi literature and watching sci-fi films
- Application of physics and art

Most cognitive motivational teaching techniques are based on experiments. That is why we try to verify the hypothesis:

*The physics experiment forms a crucial element in effective cognitive motivational teaching techniques.*

For testing this hypothesis we used the empirical educational method of a students' questionnaire. The students' ages were between 14 to 15 years. The questionnaire was applied in 2009 within 50 ungifted students (according their teachers identification) of lower secondary schools in Czech Republic. Gifted students were 20 participants of “Physics Olympiad 2009”, the same age as ungifted group. We supposed that our sample of gifted students for physics were a sufficiently representative sample of physics gifted students. We verified a research question “Which cognitive motivational techniques do ungifted and gifted students prefer?” The following questionnaire item for testing the above mentioned hypothesis was used as a suitable formulation:

*What attracts and interests you most about physics (underline as many activities as you like)?*

- *Application of physics and art*
- *Application of physics knowledge in technology*
- *Solving problem exercises and projects*
- *Use “Physics for life”*
- *Demonstrating simple experiments and toys*
- *Exploitation history related to physics discoveries and physicists' lives*
- *Seeing paradoxes and tricks*
- *Reading sci-fi literature and watching sci-fi films.*
- *Watching films, video programs and using computers (ICT)*
- *Experiencing humour in physics*

	<i>Cognitive motivational teaching technique</i>	<i>Gifted students N=22</i>		<i>Ungifted students N=50</i>	
		<i>frequency</i>	<i>%</i>	<i>frequency</i>	<i>%</i>
1	<i>Application of physics and art</i>	7	31,8	10	20,0
2	<i>Application of physics knowledge in technology</i>	10	45,5	16	32,0
3	<i>Solving problem exercises and projects</i>	8	36,4	4	8,0
4	<i>Use “Physics for life”</i>	11	50,0	26	52,0
5	<b><i>Demonstrating simple experiments and toys</i></b>	<b>17</b>	<b>72,3</b>	<b>42</b>	<b>84,0</b>
6	<i>Exploitation history related to physics discoveries and physicists' lives</i>	9	40,9	16	32,0
7	<b><i>Seeing paradoxes and tricks</i></b>	<b>17</b>	<b>72,3</b>	<b>41</b>	<b>82,0</b>

8	<i>Reading sci-fi literature and watching sci-fi films</i>	5	22,7	23	46,00
9	<i>Watching films, video programs and using computers (ICT)</i>	18	81,8	14	28,0
10	<i>Experiencing humour in physics</i>	9	40,9	24	48,0

Table 1. Cognitive motivational teaching techniques

Motivational techniques “demonstrating simple experiments and toys” and “seeing paradoxes and tricks” have highest level of the frequency of students’ answers. The cognitive motivational teaching techniques based on physics experiments strongly affect both the gifted and the ungifted students. We thus verified the hypothesis about high motivational effectiveness of school physics experiments, especially simple experiments (Trna & Trnová, 2008).

### 3 Implementation of physics experiments

Physics experiments can be used in all teaching/learning phases. Our research findings illustrate the fact that experiments used by physics teachers are not always appropriate and sufficient for development of students’ physics knowledge and skills (Trna, Trnová & Novák, 2010). We used the method of video-study (Tesch, 2005), which is based on the analysis of 62 video-recordings of physics lessons (Janík & Miková, 2006). All of physics lessons were filmed in 2004-05; the topics were „Composition of forces“(27 lessons; 8 teachers) and „Electric circuit“(35 lessons; 11 teachers).

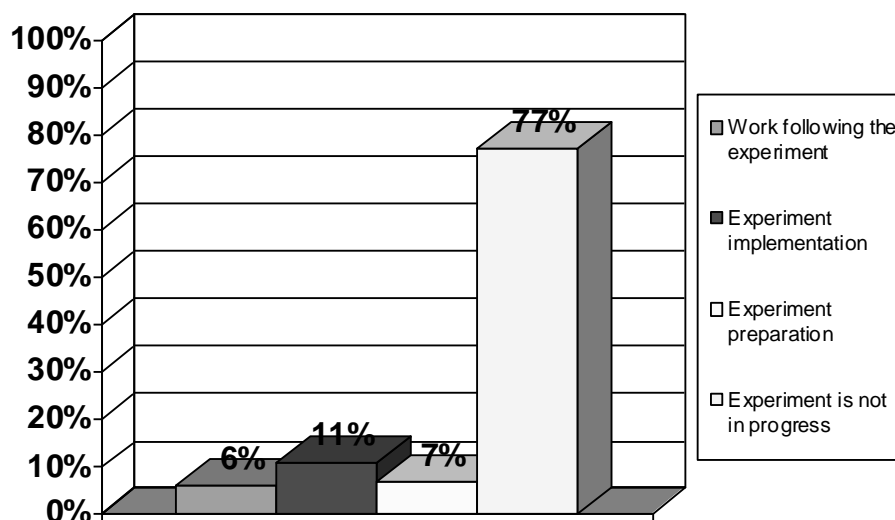


Table 2. Implementation of experiments

The category “experiment is not in progress” is the most frequent one (77%) in the analysed lessons. If we compare the results of all phases, there are unsatisfactory results: the total time spent on experimentation is insufficient and the proportion of the phases is unreasonable. Research findings based on video-study describe phases of the use of experiments and show

that experiments used by teachers are not always appropriate for improvement of students' knowledge and skills.

#### 4 Experiments in physics learning tasks

Our research findings (Vaculová, Trna & Janík, 2008) also based on video-study describe implementation of experiments in learning tasks. We realised this research in physics lessons of 13-14 years old students with the use of the video study. All 62 video-recordings of physics lessons were filmed in 2004-05; the topics were „Composition of forces“(27 lessons; 8 teachers) and „Electric circuit“(35 lessons; 11 teachers).

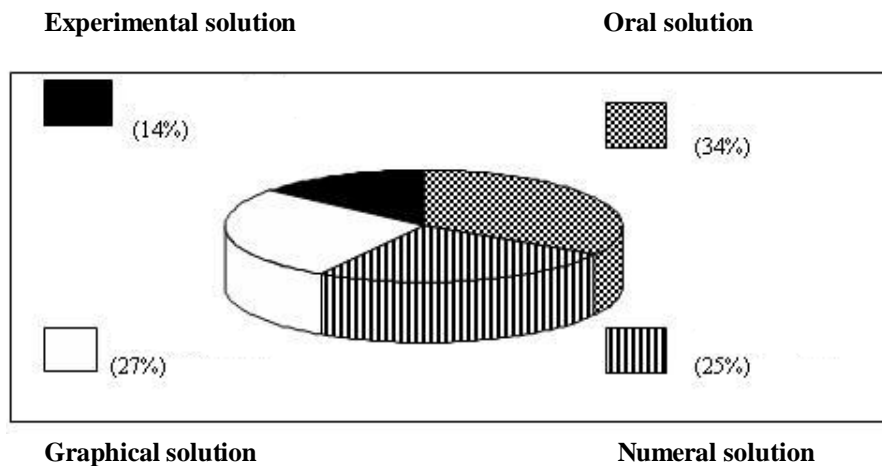


Table 3. Experiments in learning tasks

The learning tasks containing results in the form of an experiment are rarely (only 14 %) used in physics education. This is alarming research outcome.

#### 5 Simple experiments

It is possible to expect that every physics experiment has a motivational impact on students. The fact that simple experiments give the strongest motivational effect is verified by several studies (Trna, 2005). Pedagogical research based-on teaching methods are necessary for the use of simple physics experiments in every day school practice with a high level of motivational effectiveness.

The simple experiment is a special type of school experiment (Haury & Rillero, 1994). We define the simple experiment by description of its aspects which are (Trna, 2005):

- Transparency
- Activity of students
- Easy realisation
- Creativity of students and teachers
- Low costs
- Prevention of misconceptions
- Motivational effects

Simple experiments are the source of strong motivation because they can activate cognitive needs such as problem solving, but can also satisfy the needs of our senses and kinaesthetic activity. Simultaneous activation of two or more cognitive needs can result in a strong

motivational impact. Simple experiments are profitable in education, because they do not require complex and expensive equipment and students can perform them in class and at home.

From the pedagogical constructivist point of view it is important to select appropriate physics school experiments. We developed a typology of simple experiments conducive to the implementation in cognitive motivational teaching techniques.

## **6 Special motivational kinds of simple physics experiments**

Concrete examples of these physics motivational kinds of simple physics experiments are (Trna, 2008):

- Impressive simple physics experiments and observation
- Problem and paradox simple physics experiments
- Simple physics experiments in everyday and safe living
- Entertainment-edutainment simple physics experiments
- Family physics simple experiments
- Simple physics experiments supported by ICT
- Simple physics experiments for skills and creativity development

All the simple physics experiments were created from empirical research and were verified and validated using action research within a school setting.

### **6.1 Impressive simple physics experiments and observation**

This type of motivational simple experiments is connected with the emotive experience of surprise and beauty. We can include many demonstrations of optical and astronomical phenomena: a rainbow, celestial observation, discharges in gas etc.

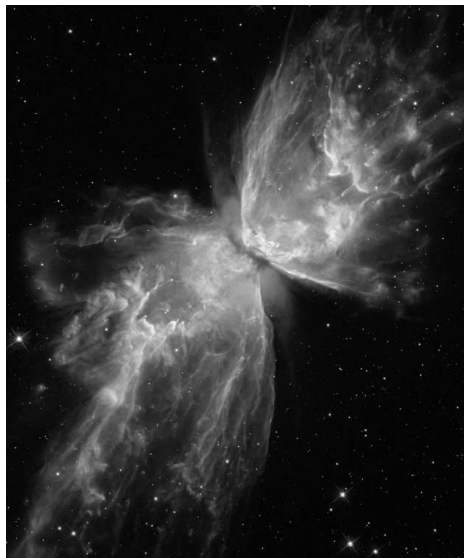


Figure 1. Butterfly Emerges from Stellar Demise in Planetary Nebula NGC 6302 (<http://hubblesite.org/gallery/>).

### **6.2 Problem and paradox simple physics experiments**

The problem and paradox simple experiment have a very strong motivational impact. We present an example of such kind of simple experiments:

*We cover a full glass of water with card (or hard paper) and we carefully press this on the surface of the water. We support the paper by hand and turn the glass upside down. Then we remove the support hand. Water won't pour out. The pressure force of the surrounding air holds the water in the glass.*

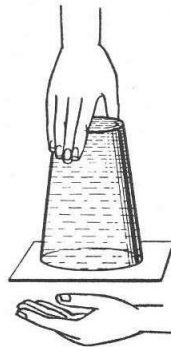


Figure 2. Air pressure effect

### **6.3 Simple physics experiments in everyday and safe living**

Everyday and safe living are two groups of very interesting educational contents used in physics education. We receive a powerful source for students' motivation by the implementation of simple experiments in everyday and safe living:

*The hydrostatic pressure in water has an effect on human organism during swimming and diving. We put the test tube with a membrane into a plastic bottle and close the bottle with a cap with valve and overpressure it with a small tyre pump. The rubber membrane buckles. This experiment simulates painful squeezing of eardrum during diving. If we fix a thin hermetic plastic wrap onto the test tube tightly, the overpressure causes the rupture of the membrane. Similarly to the membrane, the eardrum in overpressure caused by water during diving can end up perforated. The water gets to the balanced organ through the ruptured eardrum. The result should be sickness, loss of orientation and even drowning.*

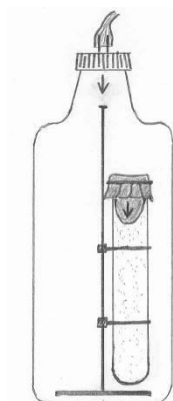


Figure 3. Model of the eardrum

### 6.4 Entertainment-edutainment simple physics experiments

The toy in the role of a simple experiment includes the need to use senses, kinaesthetic activities and relaxation function. There is successful evidence of the motivational efficiency of toys. Bubble makers, yo-yos, click-clacks, and kaleidoscopes are good examples.

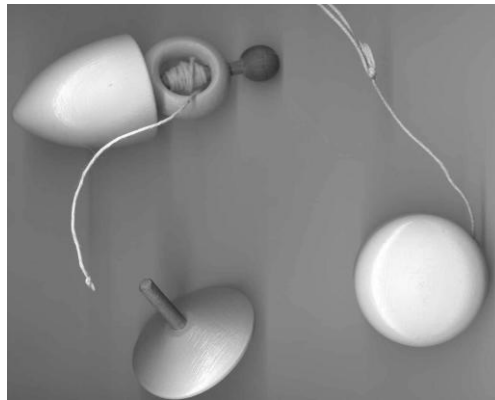


Figure 4. Wooden toys

### 6.5 Family physics simple physics experiments

Physics experimentation can be passed into families. “Family physics education” can bring families (parents and grandparents) important information about new technical equipment at home (microwave, mobile phone etc.) and also about risks in everyday living (transport, fire, poisonous materials etc.).

*We paint the sole of the foot with oil (water, paint, etc.) and we step on absorbing paper (blotter). Use a ruler to measure the widest ( $w_1$ ) and narrowest part ( $w_2$ ) of the footprint. We can calculate  $I = w_2/w_1$ . Results we evaluate by using the table.*

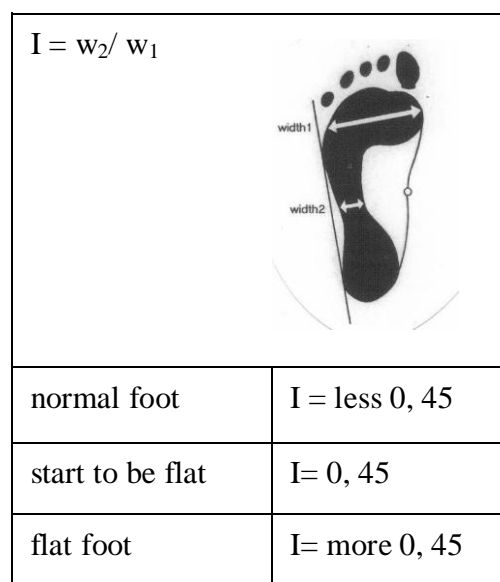


Figure 5. Flat foot

### 6.6 Simple physics experiments supported by ICT

ICT (information and communication technologies) can be use effectively for implementation of simple experiments for teaching physics. Applications of experiments by use of ICT are:



- Video recordings of experiments
- Database of video recordings and photos with descriptions on the Web
- Video handbook with instructions for teachers how to demonstrate experiments
- Video recordings of students' experimentation
- Web presentations of school experimentation
- The motivational effect of experiments is based on students' interest to use ICT

### 6.7 Simple physics experiments for skills and creativity development

Use of simple experiments in education therefore supports development of students' skills of experimentation and develops their creativity. This approach is especially profitable for physics education of gifted students. As an example, we present a simple experiment demonstrated by a teacher during a lesson and alternative simple experiment made by students:

*A glass tube with water is closed at both ends. There is an air bubble in the water. If the tube is inclined appropriately, the bubble begins to move upwards by uniform motion (constant velocity).*



Figure 6. Uniform motion – teacher's experiment

*A glass test tube with water is closed. There is a glass ball in the water. If the tube is inclined appropriately, the ball begins to move down by uniform motion (constant velocity).*



Figure 7. Uniform motion – student's alternative simple experiment

## 7 Conclusions and recommendations

School physics experiment is significant instrument for effective and motivational physics education. Simple physics experiments have strong motivational effectiveness and can be used in several cognitive motivational teaching techniques. There are several applications: impressive simple physics experiments, problem and paradox simple physics experiments, simple physics experiments in everyday a safe live, entertainment-edutainment simple physics experiments, family physics simple experiments, simple physics experiments supported by ICT, and simple physics experiments for skills and creativity development.

Not only physics teachers' knowledge but particularly acquiring skills to experiment simply is very important (Royer, Cisero & Carlo, 1993). Physics teachers' professional skills development of experimenting has three stages:

(1) Physics experimentation skill (complex competency to carry out physics experiments).

(2) School experimentation skill (complex competency to carry out school experiments).

(3) Skill to teach students by experiments (competency to teach students by school experiments).

These professional skills are acquired through experiences of the teacher and that is why acquiring these skills is not possible during pre-service teacher training and especially into in-service training.

Our findings were supported also by international projects as SYSTEM, EUSTD-web and MOSEM.

Our future research and development problems are:

- To discover new motivational teaching techniques
- To study cognitive structure of motivation of students
- To state rules for measuring motivational effectiveness of experiments
- To produce motivational tools, especially simple experiments

## 8 References

- Haurry, D. L. , Rillero, (1994). P. Perspectives of Hands-On Science Teaching. Columbus : ERIC-CSMEE.
- Janík, T. , Míkova, M. (2006). *Videostudie*. Brno: Paido.
- Royer, J. M., Cisero, Ch. A. , Carlo, M. S. (1993). Techniques and procedures for Assessing Cognitive Skills. *Review of Educational Research*, (2), pp. 201-243.
- Tesch, M. (2005). *Das Experiment im Physikunterricht: Didaktische Konzepte und Ergebnisse einer Videostudie*. Kiel : IPN.
- Trna, J. (2008). Hands-on Activity as a Source of Learning Tasks in Science Education. In *HSci2008. Formal and Informal Science Education*. Braga : University of Braga, pp. 78-82.
- Trna, J. (2005). Motivation and Hands-on Experiments. In *Proceedings of the International Conference Hands-on Science in a Changing Education. HSci2005*. Rethymno : University of Crete, pp. 169-174.
- Trna, J., Trnová, E (2006). Cognitive Motivation in Science Teacher Training. In *Science and Technology Education for a Diverse World*. Lublin : M. Curie-Sklodovska university press, pp. 491-498.
- Trna, J., Trnová, E (2008). The motivation of gifted students through a natural experiment in learning tasks. In *Education and Talent 2*. Brno : MSD, pp. 32-46.
- Trna, J., Trnová, E, Novák, P. (2010). Improvement of science and technology literacy by means of ICT-based collaborative action research including hands-on experiments. In *HSci2010. Bridging the science and society gap*. Rethymno : University of Crete, pp. 326-332.
- Vaculová, I., Trna, J., Janík, T. (2008). Učební úlohy ve výuce fyziky na 2. stupni základní školy: vybrané výsledky CPV videostudie fyziky. *Pedagogická orientace*. 18, (4), pp. 59-79.

# LEDs in Water: Hands-on Electric Field Lines and Electric Potential

Leoš Dvořák <sup>a</sup>, Gorazd Planinšič <sup>b</sup>

<sup>a</sup> Dept. of Physics Education, Faculty of Mathematics and Physics,  
Charles University in Prague, Czech Republic  
e-mail: [leos.dvorak@gmail.com](mailto:leos.dvorak@gmail.com)

<sup>b</sup> Faculty for Mathematics and Physics, University of Ljubljana, Slovenia  
e-mail: [gorazd.planinsic@fmf.uni-lj.si](mailto:gorazd.planinsic@fmf.uni-lj.si)

## Abstract:

It is well known that concept of electric field and electric potential and relation between them are one of the hardest to grasp at secondary level and even at university level. We propose a simple experiment using light emitting diodes (LED) that can be used at various levels to elucidate these concepts and demonstrate their behaviour. The experiment can be considered as an example of “multilayered simple experiments” that the authors introduced at GIREP 2009 conference [1]. Some details of the proposed experiments represent interesting problems on their own. Suggestions how to treat such problems theoretically and to compare the results with real experiments are presented.

## Introduction

Concepts of electric field  $\vec{E}$  and electric potential  $\varphi$  are not easy for both high school and university students, at least at introductory university level. Visualization of equipotential lines in lab experiments often uses voltmeters or sensors connected to computers to measure potential either in electrolytic tank or at weakly conducting carbon paper. However, as it is pointed out e.g. by Knight [2], research showed strong evidence that most students gain little or no knowledge of electric potential from such lab experience. He explicitly stated that “The majority of students did not know what the voltmeter measured. When asked questions about the electric field, nearly all students answered by referring to the electrodes and to the terminals of the power supply, rather than to any measurements they were making with voltmeter.” ([2], p.221-222)

We are suggesting that experiments using simple “local indicator” in a fish tank with water can help students to visualize the electric field and equipotential lines in clearer way and offer interesting examples students can discuss and use when learning these concepts.

These experiments can be treated at various levels, from primary to university, and can be seen as an example of “multilayered simple experiments”, the concept we introduced at GIREP 2009 [1].

## Experimental setup

The basic experiment is not a new one. It was presented by V. Cigánik at the conference “Šoltésove dni 2003“ in Bratislava, Slovakia. V. Cigánik was then Ph.D. student at Faculty of Mathematics, Physics and Informatics, Comenius University, Bratislava. The experiment was probably originally invented by him and/or some other people at that Faculty. We are not aware of any previous work describing the experiment; according to our knowledge it also was not published later. It is a pity that such a great idea is unknown - that is the reason why we now (after years of using it by one of us mainly just as a “wow experiment” at some seminars for teachers) decided to present it to wider audience, suggesting some new didactical applications and analyze several of its interesting details.

The basic idea of the experiment is shown at Fig. 1. LED is put in a fish tank filled with water. An electric field (due to the electrodes at the sides of the fish tank) causes a current to flow through the water. Part of the current goes through the LED and the LED glows. The whole situation is similar to a “normal” electrolytic tank, we just use LED as a “local indicator” of the field. Fig. 2 shows the real experiment.

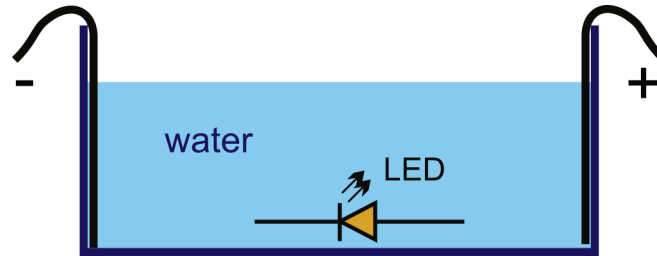


Fig. 1. The basic idea of the experiment

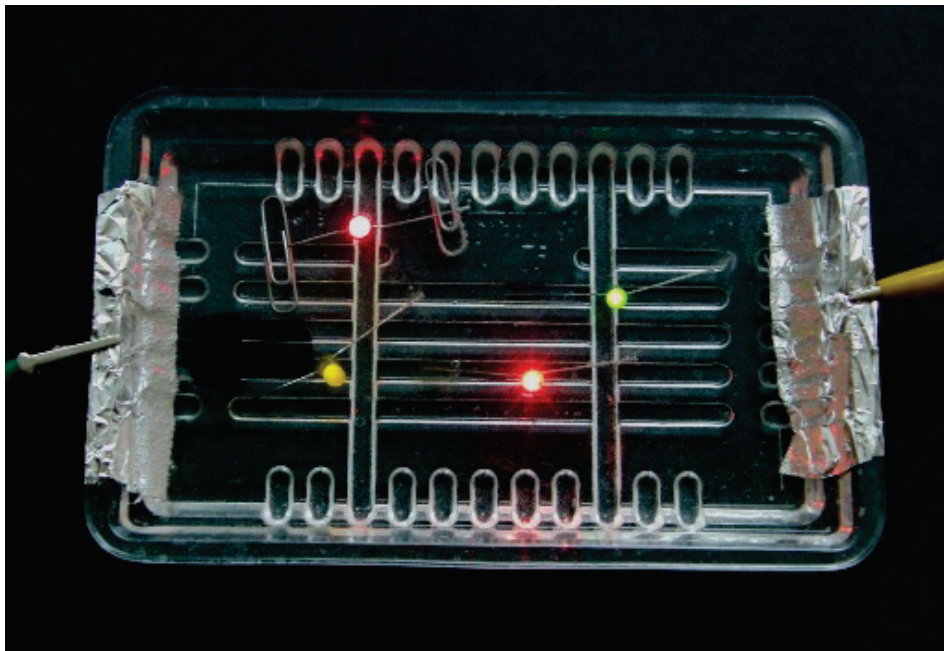


Fig. 2. LEDs in water – the real experiment

### **LEDs in water as a multilayered experiment for primary and secondary level**

How such an experiment can be used in teaching and learning physics? We can utilize it at different school levels, for slightly different purposes and, of course, discuss and try to understand it at various depths. It may serve as an example of the approach with increasing cognitive demands (see [1]).

At **primary school level** (either at schools or at physics clubs for kids) it can be used merely to create excitement. The beauty of glowing LEDs of various colours such as shown at Fig. 3 can attract kids and increase their curiosity.

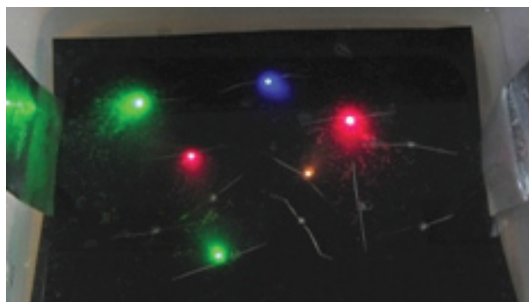


Fig. 3. Young children can just enjoy in observing glowing LEDs

Of course, even at this level the kids can learn something. They can see that:

- “Electricity” goes through the water (an important issue for the safety!).
- Orientation of LED matters.

(Note: At a primary school level we would use the vocabulary like that. There is no need to speak about electric field etc.)

There is one safety warning to keep in mind when performing the experiment (not only at primary level). The required voltage between the electrodes for a 20 cm fish tank is about 30 V (certainly more than about 15-20 V, see the experiments later in this text). And the environment is more than wet, it is water itself! So kids should not put their fingers into water.

At **lower secondary school level** (for pupils of age 12-15) the experiment could be used in physics or science classes. One important reason why to use it is the motivation. The experiment is perhaps even *more surprising* for pupils who already learnt that for a light bulb or LED it is necessary to connect both leads to the battery or to some other voltage source. Here LEDs glow without any visible wires connected to them. Pupils can learn that:

- Electric current can flow through water. (It is basically the same observation as at the primary level but now the concept of electric current can be used in the description and explanation of the experiment.)
- Orientation of LED matters - again the point mentioned above but now pupils can purposefully experiment as Fig. 4 shows. By this they can see that:
- If LED’s leads are oriented in the direction connecting the electrodes at sides of the tank the LED glows brightly. If we tilt the LED it glows dimmer, as if connected to a “weak battery”. This may be a first step towards building a concept of voltage (voltage as a potential difference). Hopefully at least some pupils can grasp the idea.

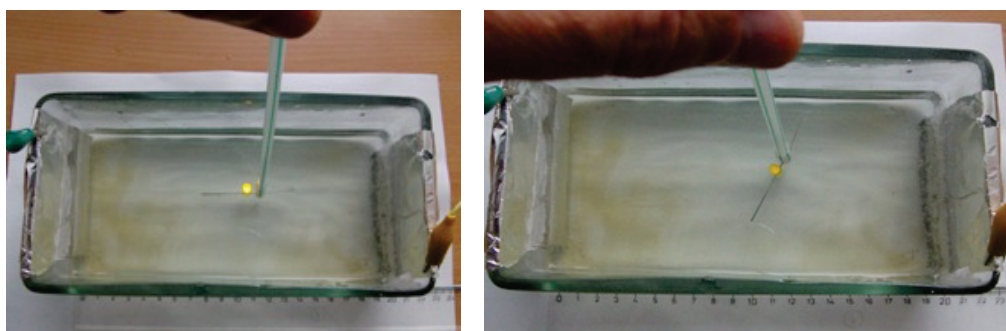


Fig. 4. At lower secondary level the brightness of LED can be interpreted to tell something about a voltage between different points

At **high school level** the experiment can help to elucidate the following additional points:

- The concept of potential difference. This can be investigated and discussed in greater details using LED as a local indicator. (Greatest brightness of the LED corresponds to the orientation in the direction of the electric field, if LED's leads are in places where the potentials are the same the LED does not glow at all, etc.)
- The field need not be only homogeneous. Shape of an electric field in more complicated situations can be studied placing the electrodes connected to a battery into different positions as it is shown at Fig. 5.

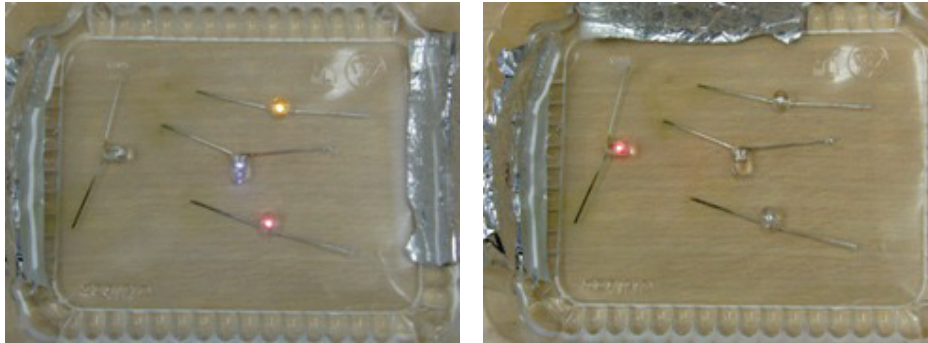


Fig. 5. LEDs indicate that changing the position of electrodes changes the shape of the electric field

At high school level such experiments can be part of either normal teaching or labs or students' projects. Of course, further piloting and research will be needed to develop concrete teaching-learning sequences in physics or science classes at various levels of schools and to find out their impact on students' understanding of electric field concepts. Nevertheless, the simplicity of the overall arrangement of the experiment enables its use as a cheap and easily adaptable alternative to more cumbersome and perhaps less clear experiments traditionally used in this area.

### LED's in water as problems for university level: the field near the electrodes

At an introductory university level the experiment, apart from its "wow aspect", can provide motivation for more detailed investigation. As we shall see it provides several interesting problems. Their solution and results illustrate some concepts from the areas of electrostatics and stationary currents and can be useful for lectures on Electricity and Magnetism or Classical Electrodynamics.

One example of such question is: *Should we isolate parts of LED's leads?* Intuitively it seems it should be useful to isolate inner parts of leads to prevent "short-circuiting" the current through the water near the LED or in other words, to achieve larger potential difference between the LED leads (see Fig. 6).



Fig. 6. Should inner parts of LED be isolated as indicated in order to increase LED's brightness?

The experiment shows that the brightness of LED with isolated inner parts of leads is practically the same as in the case of LED with bare leads (at least if the voltage between outer electrodes is not too low). Let's investigate what is going on.



For solving the above mentioned problem it is necessary to explore the electric field in the vicinity of LED's leads.

This can be a good starting point motivating us (and also students) to calculate the field theoretically by solving the Laplace equations. We will not repeat here the explanation why the field in a water tank fulfils Laplace equation. Instead, we will just shortly comment on how the problem can be solved and present some results. We would like to note that a problem like this provides a good motivation for students to solve Laplace equations - perhaps better than standard, sometimes artificial end of chapter problems.

Of course, to be able to solve the problem easily, we should simplify the situation. We will consider cylindrically symmetric situation described by Fig. 7. The leads of the LED are at the axis, the outer electrodes with potentials  $\varphi = -U_0$  and  $\varphi = +U_0$  form the lower and upper base of our cylinder. So the total battery voltage is  $U_{bat} = 2 \cdot U_0$ . There is no electric flux through the vertical surface  $R = R_{max}$ .

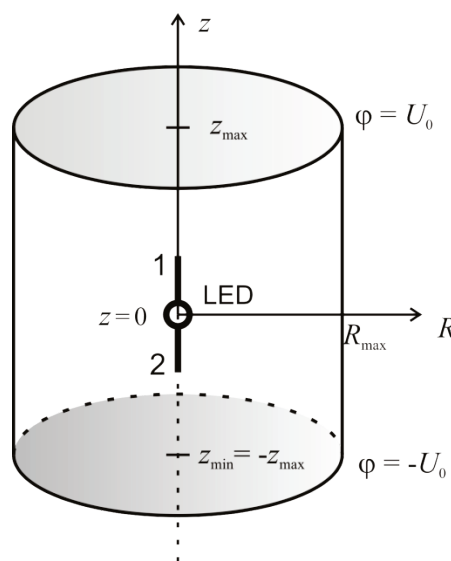


Fig. 7. LED in water – simplified situation for the calculation

A simple reasoning can help us to determine the potentials at LED's leads 1 and 2. The voltage on the LED is approximately constant and does not depend (nearly at all) on the current through the LED. We considered this voltage to be 2 V. (This is roughly right for a yellow LED. It is a good approximation except for the case of very low current through the LED.) For a symmetrical situation considered here it follows that the potentials of the leads are  $\pm 1$  V. (For LEDs of other colours the voltage would be slightly different.)

Now we can solve the Laplace equation numerically. To do this we have used successive overrelaxation method ([3], [4]). It is sufficiently simple so that its idea can be easily explained to students and yet it converges reasonably fast. We have used meshes from 40x40 to 200x200 points. We will not present here any details concerning the numerical solution. Instead, we will show and interpret some results.

Fig. 8 shows typical equipotential surfaces. (This case corresponds to the voltage between electrodes equal to 32 V for a tank of length 20 cm; only part of water of size 10x10 cm is shown at the figure.)

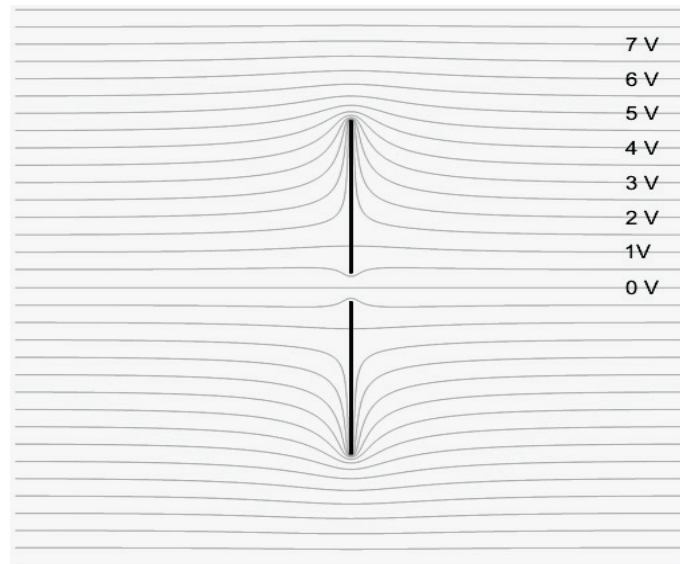


Fig. 8. The overall view of equipotential lines for LED (only leads are shown) in a “model fish tank”

It can be clearly seen that the electric field is strongest near the tips of leads. Therefore also the current density to the lead is strongest near the ends. Fig. 9 shows this in a greater detail. The right graph at Fig. 9 presents the total current into the LED’s lead from a given point ( $z$  is the distance from the centre of the LED) to the end (i.e. the tip) of the lead. It can be seen that the “last centimetre” of the lead contributes to more than 2/3 of the total current. At the inner part the current either into or out of the lead is small and does not influence the total current very much. This is the reason why insulating the inner part of the leads practically does not affect the total current and therefore the brightness of the LED.

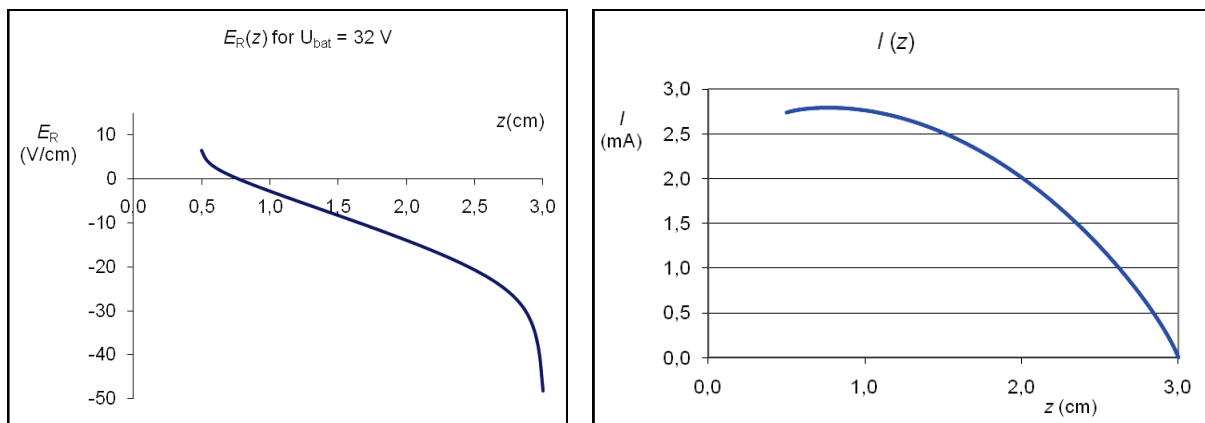


Fig. 9. Radial component of electric field near the LED’s lead and total current flowing into the LED’s lead from given  $z$  to the end of the lead ( $z_2 = 3\text{ cm}$ ).

Theoretical solution should be compared to real experimental results. One possibility is to compare total current through the LED computed by numerical solution with a current really measured. We did it for several values of battery voltage; the results are summarized in Fig. 10. According to a theoretical simulation the current increases linearly with the battery voltage. (We can discuss with students that this is a natural consequence of the fact that the Laplace equation is linear and we postulated constant voltage at LED’s leads.) The experimental results show the same behaviour and also the “threshold” is nearly the same. (The real behaviour near the threshold is caused by nonlinearity of LED, particularly by the



fact that the voltage at LED for low currents is no more constant.) The measured current is slightly less than calculated one but surely we cannot expect a perfect agreement: in reality LED is not in an infinite ocean of water or in a centre a cylinder filled with water but lies at the bottom of the tank. Taking all this into account the agreements seems to be surprisingly good.

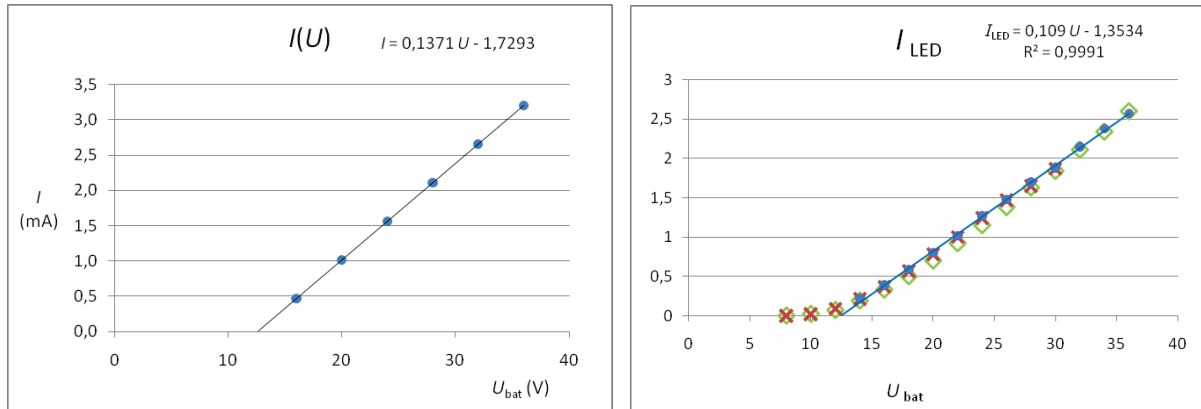


Fig. 10. Total current through the LED as a function of the battery voltage: results of simulations (left ) and measurements (right )

We omit here further results concerning the behaviour of the field near leads for low battery voltage close to the threshold where LED stops glowing. In this case a real “short-circuiting” of inner parts of leads occurs and insulating these parts may increase the current through the LED. These results will be published elsewhere.

We conclude our comparison of theory and experiment by two qualitative observations. The current going into LED’s lead is “visualised” by bubbles (of hydrogen) rising from the lead - see left photo at Fig. 11. It can be clearly seen that most of the bubbles rise near the end of the lead. At the other lead the oxidation of the surface of the lead causes the surface to become dark (see right photo at Fig. 11). Again, the part of the lead close to the LED stays shiny indicating that the current “prefers” the part closer to the end.

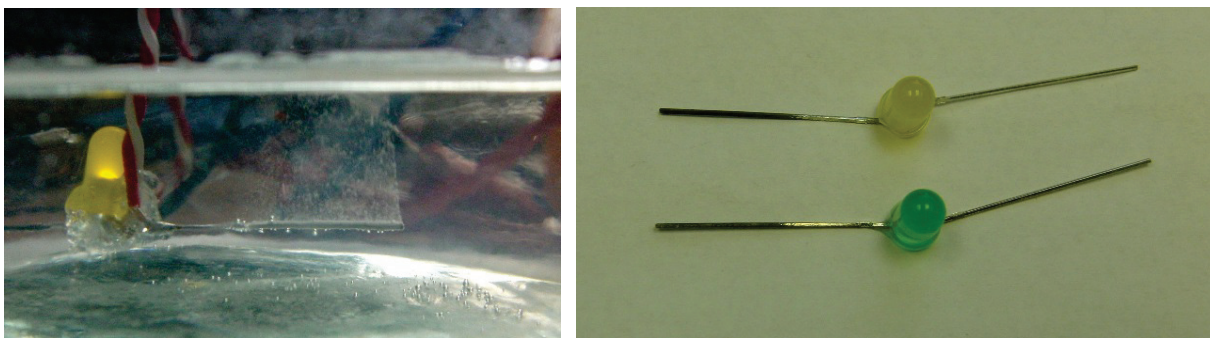


Fig. 11. The presence and even the relative size of the current going into LED’s anode can be inferred by the bubbles of hydrogen that form due to electrolysis of water (left); the part of the (other) lead through which the current goes is also identifiable by a change of colour of the surface of the lead due to oxidation.

## Conclusions

We have shown that LEDs can be used to visualize electric field and potential in more direct and hopefully more effective way than other well known methods. We have, at least partly, explained the behaviour of the field and electric current near the LED in water. Such deeper understanding is useful also for designing experiments with LEDs in water for high school

and lower secondary level. Note that just some investigations and results were presented in this short article. More detailed treatment, which we intend to publish elsewhere, would include for example the behaviour of field and current in cases when the voltage is lower (and the LED stops to glow) or the problem to what distance the field in water is substantially distorted by the presence of a LED.

As we already stated above, further development and research would be also useful concerning the use of these types of experiment in teaching and learning at various levels of schools and its influence of students' understanding of concepts related to electric field.

Part of this study was supported by bilateral Czech-Slovenian project MEB090907 "Support of scientific reasoning development of students and teachers in physics classes through active learning".

## References

- [1] Planinšič G., Dvořák L.: *Multilayered simple experiments: an approach with increasing cognitive demands*. In: Physics Community and Cooperation: Selected Contributions from the GIREP-EPEC & PHEC 2009 International Conference, Ed. D Raine, C Hurkett, L Rogers (Lulu/The Centre for Interdisciplinary Science, Leicester, 2010) ISBN 978-1-4461-6219-4.
- [2] Knight R D: *Five Easy Lessons - strategies for successful physics teaching*, Addison Wesley, 2004
- [3] DiStasio M., McHarris W.C.: *Electrostatic problems? Relax!* Am.J.Phys. 47 (1979), No.5, 440-444.
- [4] Press W.H., Flannery B.P., Teukolsky S.A., Vetterling T.W.: *Numerical Recipes. The art of scientific computing*. Cambridge Univ.Press Cambridge, London, N.Y. 1986.

# Why Does an Electric Toy Car Move Uniformly?

Lea Valentina Lavrik, Vladimir Meir Shunyakov

[lealavr@yahoo.com](mailto:lealavr@yahoo.com)

*Lifshitz Academic College, Jerusalem 2308, Israel*

**Tatiana Olevski**, *learning center "Lingua. Com", Israel*

## ABSTRACT

We consider the problem of the stability of the uniform motion of a little electric toy car. Although the problem of stability of motion goes far beyond basic science, we were able to explain many aspects of this phenomenon, in the framework of high school physics. Our goal is to determine which forces influence the electric toy car; in particular, what are the sources of the braking force. We show that the stabilization of the car's motion is a manifestation of electromagnetic induction. In this work, we discuss the problem of the difference between uniform motion of the machine with the working engine and the uniform motion of bodies by the inertia as well.

## INTRODUCTION

A. Einstein and L. Infeld had formulated the remarkable metaphor about scientific cognition in their book "The Evolution of Physics"[1].

"Physical concepts are free creations of the human mind, and are not, however they may seem, uniquely determined by the external world. In our endeavor to understand reality we are somewhat like a man trying to understand the mechanism of a closed watch. He sees the face and the moving hands, even hears its ticking, but he has no way to open the case. If he is ingenious he may form some picture of a mechanism which could be responsible for all of the things he observes, but he may never be quite sure his picture is the only one which could explain his observations..."

Our goal is to realize the Einstein-Infeld metaphor in practice, but instead of the watch, we will consider a little electric toy car. The main goal is to solve the problem of why does the electric car move uniformly.

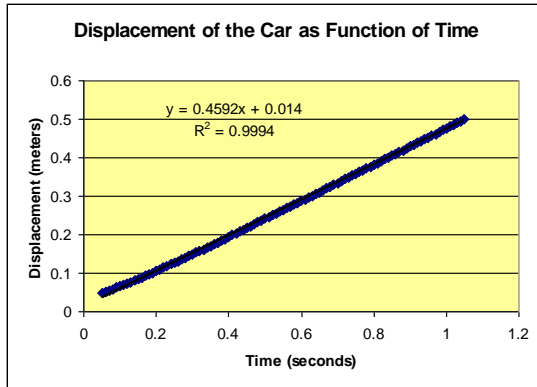
This problem is a practical one, because in physics lessons, we need to demonstrate uniform motion. The electric toy car is a most effective and cheap device for this demonstration. The uniform motion of the electrical toy car provides a repeatable, reliable and established result. Moreover, it is possible also to carry out many other demonstrations and lab assignments studying mechanics and electromagnetism by using electric toy cars.

In this paper, we consider in detail three different aspects of the problem of stability of uniform motion of the electric car:

- 1) The mathematical formulation of the principles of sustainable uniform motion.
- 2) The specific analysis of the forces acting on a moving car: in particular, what is the physical nature of the retarding force which depends on the speed?
- 3) The principle of inertia. What is the difference between the uniform, inertial motion of a body and the uniform motion of the electric car?

## II. STABILITY CONDITIONS OF UNIFORM MOTION

The uniform and rectilinear motion of an electric car is an example of an established and repeatable proven result. The car's velocity may be different in different conditions: it depends on external loads and quality of the batteries. At the same time, the velocity does not change over the course of the motion.



Moreover, the car's uniform motion is stable if the resistive force depends on the car velocity. The car moves uniformly, if the forces, acting on it, balance each other. If the velocity is increasing, the magnitude of the resisting force is increasing, too. However, its sign is negative. It means that the sign of the resulting force is negative, too. If the resulting force is negative, it is pushing the car backwards. If the velocity is decreasing, then the resisting force is decreasing, but the resulting force is positive. The resulting force is pushing the car forward. By this way the uniform motion of the car is supported.

The mathematical aspects of this problem have been discussed by V.G. Boltyanski [2]. We should note that in the work [2], the physical nature of the pulling force and the resistance force is not discussed. In this paper, we focus principally on the physical nature of the forces that lead to the stabilization of uniform motion.

### III. FORCES THAT INFLUENCE THE CAR'S MOTION

We know from our everyday experience that the rotating wheels of a car touch the road and push the road backward.

$$I\dot{\omega} = \tau_{motor} - \tau_{axis} - F_{stat}R \quad (1)$$

Equation (1) describes the rotation of the wheel. Its moment of inertia is designated  $I$ , and the engine torque acting on the wheel is indicated by  $\tau_{motor}$ . We suppose that the engine torque does not change and does not depend on velocity. The moment of the static friction force of the wheels on the road is indicated by  $F_{stat}$ , and the torque of friction between the rotating shaft and housing is indicated by  $\tau_{axis}$ . The interaction force between the wheels and the road is the static friction force,  $F_{stat}$ . The force of static friction relates to the type of reaction force. The reaction forces are not dissipative forces, and according to d'Alembert's principle [4], they do not produce any work in a system.

The road pushes the car forward, according to Third Newton's Law, by the static friction force. The equation for translational motion is

$$M\dot{v} = F_{stat} - F_{ext} - F_{resist}(v) \quad (2)$$

In equation (2),  $M$  is the mass of the cars, and  $F_{ext}$  is the force due to an external load. We do not know the physical nature of the resistance force  $F_{resist}$ , which depends on the speed. It may be, for example, the force of air resistance. The velocity of the wheel at the point where it touches the road is equal to zero, because at the contact point the wheel's rotating velocity balances the car's forward velocity. Balance between speeds of translational and rotational motions at the point of contact between the wheel and the road is described by the following equation

$$v - \omega R = 0 \quad (3)$$

Equations (1), (2), (3) describe the mechanical motion of the car. Equations (1) and (2) represent Newton's Second Law for the wheel's rotation and for the car's forward motion. Equation (3) represents the constraint condition between rotation and forward motions, and it shows mutual dependence between these kinds of motion.

If the resistance force depends on velocity, then Equation (2) satisfies the stability condition of uniform motion, which was formulated in the previous section. Equation (2) implies that as a constant external force is directed against the forward movement, the constant speed of the car should decrease.

Let us check this dependence. We connect a rope to the back part of the car. The rope passes over a pulley. The weight represents the set of rings on the hanger, and it increases as the car moves. We change the weight by adding a new ring and then we repeat this procedure.

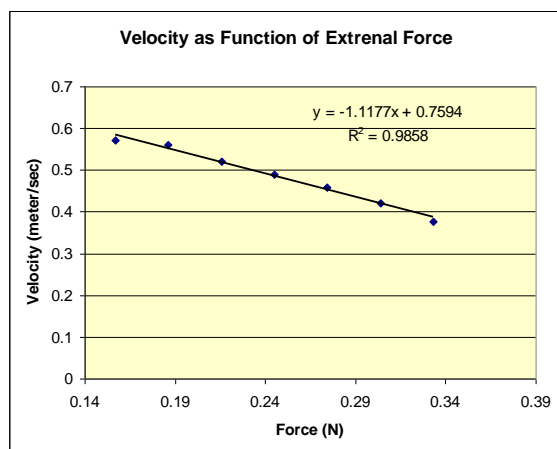


Figure 1: The speed of car depends on the external force, which pulls the car backward.

The main result of this experiment is the following: the magnitude of the velocity decreases linearly as the weight increases. From the plot in Fig. 1, we can estimate the value of a constant force that pulls the car forward. Strictly speaking, a linear relationship between the velocity and external load takes place only over a small range of forces. A further increase in weight leads to a transition to the regime of a sliding motion, and then to a full stop. The full stop comes when the load is from 0.4 - 0.5 N. Thus, from this experiment, we receive an order of magnitude of the force,

which pulls the car forward. Let us consider the case where this force is equal to 0.4 N.

According to the Newton's First Law, any body moves uniformly if a resulting force influencing its motion is equal to zero. The resistance force, which pushes the car backward, may be only the force of air resistance. The air resistance force is the quadratic function of a body velocity [3]:

$$F_{air} = -\mu S \frac{\rho_{air} |\vec{v}| \vec{v}}{2} \quad (4)$$

where  $\mu \approx 0.4$  - the dimensionless factor that depends on the shape of the body.

The quantity  $S$  is the area of a frontal section of the body, which is perpendicular to the velocity of the moving body. A frontal cross section of the toy car is on the order of magnitude of about  $S \approx 25 \text{ cm}^2 = 2.5 * 10^{-3} \text{ m}^2$ . The equation also includes the air density,  $\rho_{air} = 1.3 \text{ kg/m}^3$ .

The air resistance force increases in magnitude as the speed of the car increases. At a certain critical velocity, a pulling force coincides to the resistance force, and motion becomes uniform. Let us verify whether air resistance is significant in the motion of the toy car.

In the third section, we estimated the order of magnitude for the force pulling a toy car. Assuming that the pulling force is constant and does not depend on the speed, we see that its magnitude is 0.4 N. We can find the speed at which both forces are balanced. We equate the pulling force = 0.4 N, and the air resistance force (7). The speed at which both forces are balanced is 28 m / sec. This value is much higher than the characteristic speed at which an electric toy car moves, at 0.2-1 m / sec. At such speeds, air resistance is much smaller than the pulling force, and therefore its influence can be neglected.

#### IV. HYPOTHESIS ABOUT THE PROPERTIES OF TORQUE CREATED IN ELECTRIC MOTORS

We can eliminate the angular velocity from the system of equations in order to obtain only one effective equation.

$$\left( M + \frac{I}{R^2} \right) \dot{v} = \frac{\tau_{motor} - \tau_{axis}}{R} - F_{ext} \quad (5)$$

The effective driving force is proportional to the torque which rotates the wheels. If the car moves uniformly, then the driving force and the torque are equal to zero. This effective equation corresponds to simple intuition that "the engine pulls the car". In this case, we forget about the road's impact on the wheel, and we assume that the motor is the only source of the pulling force.

The total torque which acts on the wheel is smaller than the torque created by the motor. It overcomes the torque of sliding friction on the wheel's axis and on the transmission. An effective pulling force is associated to the total torque. The external force  $F_{ext}$  counteracts the movement. In spite of the fact that the force of static friction has been eliminated from the effective equation (10), it can be found by solving equations (1), (2) and (9).

$$F_{stat} = (1 - \lambda) \frac{\tau_{motor} - \tau_{axis}}{R} + \lambda F_{ext}; \lambda = \frac{I}{MR^2 + I} \quad (6)$$

Equation (6) is valid when the right side does not exceed the value of  $\mu_{stat} * Mg$ . Using equation (6), we can solve a curious paradox. We face this paradox in the study of bodies moving on wheels. As mentioned above, the main source of external forces affecting the car's movement is the road surface. Nevertheless, at the same time, we are able to put the car in motion, to accelerate its movement, to slow down the motion, or to stop it. The question is: if all this is happening due to the impact of the road, how the road does "know" when it is necessary to stop the car, or when it does need to speed it up or slow it down?

Equation (6) gives the answer to that question. The answer is that the static friction force is the reaction force. It was determined through the moment force applied to the wheel and through the other outside forces. The moment of force can be controlled by sitting in the car, and thus to manage the magnitude and direction of the static friction force. Thus, if the machine moves with constant velocity, and the external force applied to it is zero, then the total torque applied to the wheel must also be zero.

This conclusion leads to a new paradox. If the torque generated by the motor is constant in magnitude, then uniform motion of the car is virtually impossible. Since in the original equations we did not find any forces that depend on speed, then it seems reasonable to formulate the following hypothesis: the torque applied to the wheel by the motor depends on the angular rotational speed, and decreases with its growth. For simplicity, assume that the torque decreases linearly with increasing angular velocity. Without loss of generality, we propose an expression for the torque, which decreases linearly with increasing angular velocity, as follows.

$$\tau_{motor} = \tau_0 \left( 1 - \frac{\omega}{\omega_0} \right) \quad (7)$$

Here  $\tau_0$  may be interpreted as the maximal value of the torque which is produced by the motor. We can estimate it by measuring the minimum moment of external forces which stop the rotation of the running engine. The parameter  $\omega_0$  may be interpreted as the maximum angular velocity of the motor. It is practically impossible to achieve this angular velocity, because even in the absence of external loads, there is internal friction. The effective equation takes the form

$$\left( M + \frac{I}{R^2} \right) \dot{v} = \frac{\tau_0 - \tau_{frict}}{R} - \frac{\tau_0}{\omega_0 R^2} v - F_{ext} \quad (8)$$

The static friction force (11) also contains a "viscous contribution" due to the dependence of the torque on the angular velocity

$$F_{stat} = (1 - \lambda) \left( \frac{\tau_{motor} - \tau_{axis}}{R} - \frac{\tau_{motor}}{\omega_0 R^2} v \right) + \lambda F_{ext}; \quad (9)$$

Thus, only the static friction force influences the motion of an electric car. Besides the static friction force, no other external force influences the motion of the car. Moreover, the static friction force represents the difference of two terms. The first of these can be interpreted as a 'pulling force', which pushes the machine forward. The second term is the "friction force" that depends on the speed. It remains an open question as to why the torque generated by the motor (6) depends on the angular velocity of the wheel.

## V. DYNAMICS OF THE MOTOR

Schematically, the electric DC motor represents a conductive frame which can freely rotate in a magnetic field. When an electrical current flows along the frame, the magnetic field produces a torque which influences the frame rotation. The torque is proportional to the electric current, according to the Ampere's Law [7].

In order to obtain rotational motion, you need to change the polarity of the contacts on the inner rotating frame every half period. This may be achieved by using sliding contacts - brushes, which change polarity on the inner contacts of the rotating coil. In this case, the torque acting on the frame with the current keeps the same sign throughout the entire process of movement. We write the expression for the torque as

$$\tau_{motor} = I\Phi_{max} |\sin(\theta)| . \quad (10)$$

In the circuit containing the motor, there are two sources of electricity. The first source is a battery. The second source of electricity in the circuit is the engine itself, more specifically, the magnetic field of the rotating coil. The rotating coil creates an EMF by electromagnetic induction in the circuit. Its sign is opposite to the battery's EMF, and its magnitude is proportional to the angular velocity of the frame.

Ohm's law for this circuit is given by

$$I(R+r) = E_{batt} - E_{ind} = E_{batt} - \omega\Phi_{max} |\sin(\theta)| \quad (11)$$

Here "R" and "r" denote the resistance of the coil and the internal resistance of the batteries, respectively.

Because the torque is proportional to the electrical current by Ampere's Law (10), we obtain the dependence of the torque on the angular velocity of the rotation. We can write the expression for the torque, averaged over the various orientations of the frame, in an explicit form.

$$\tau = \tau_{max} - \omega \frac{\tau_{max}}{\omega_0} = \frac{2}{\pi} \frac{E_{batt} \Phi_{max}}{R+r} - \omega \frac{\Phi_{max}^2}{2(R+r)} \quad (12)$$

Equation (12) shows that the torque created by the motor consists of two parts. One part is constant and it makes the wheel rotate. The second part depends on the angular velocity. It is negative and prevents rotation.

The static friction force can be decomposed into two parts. One of them pulls the car forward, while the other depends on the speed and pushes the car backward. This is the solution to the puzzle regarding the stability of uniform motion of the machine.



Otherwise, we can say that a stable and uniform motion of the car is essentially a manifestation of the law of electromagnetic induction.

## VI. DISCUSSION

Formally, the uniform motion of an electric toy car satisfies the conditions for inertial motion. Nevertheless, our intuition and common sense do not agree with this formal conclusion. The objection that immediately comes to mind is: why does a car stop immediately upon turning off the engine? It turns out that inertial motion occurs only while the motor is running.

What is the difference between the "true movement of inertia" and the uniform motion of the car on a level road? Strictly speaking, the uniform motion of an electric car is only an average. The static frictional force and torque which act on the wheel from the road and from the engine are pulsing functions of time. A non-trivial feature of the system being studied is that the magnitude and direction of an external force, which is the static friction force, can be controlled from inside the car. And, although managing the external force from within the system is not such a rare phenomenon, the discussion of this phenomenon is not in the curriculum even in many university courses.

Moreover, in physics courses they usually assume that uniform motion is realized only under the condition where two or more external forces strictly counterbalance each other. But by using this assumption, we are not able to explain many of the usual phenomena occurring in the world around us. Simplifications are inevitable, and it is impossible without them.

In elementary physics courses, the motion of complex objects is seen as movement of a point mass acted upon by an external force. When a teacher explains the motion of a person walking along the road, he says that the static friction force acts on person's feet from the ground. However, the instructor must be prepared to respond to another completely obvious question: what force balances the static friction force when a person moves at a constant speed? This is the subject of this paper.

## References

1. Einstein, A., Infeld, L. (1967) *The Evolution of Physics*, Touchstone.
2. Boltianski, V. (1974) "Bivayet li ravnovernoye dvizhenie? (Does an uniform motion exist?)", *Kvant*, **12**, 2 – 6.
3. Landau, L., Lifshitz, E. (1987) *Course of Theoretical Physics, VI, Fluid Mechanics*, Butterworth-Heinemann; 2nd edition
4. ter Haar, D. (1971) *Elements of Hamiltonian Mechanics*, Pergamon Press, Oxford.

# Shadows

Nada Razpet

University of Primorska, Faculty of Education Koper

University of Ljubljana, Faculty of Education

nada.razpet@guest.arnes.si

## **Abstract:**

Shadows are one example of phenomena that we experience in every day life. Indoors, lamps and other sources of artificial light create shadows when objects are placed in the path of the light rays.

Students of primary and secondary schools may not recognize by themselves the intimate connection between physics and mathematics. For them it may be quite a motivating experience when they become aware of connections between different school subjects. Physics teachers should therefore show real-life examples, where skills and concepts obtained at abstract courses of mathematics can be effectively used. On the other hand, mathematics teachers can occasionally illustrate mathematical concepts by looking at appropriate physical objects. Shadows offer a variety of examples where geometry can be used and studied.

First we look at a photograph of the shadow of the mountain Špik. The shadow has a triangular shape and from it we can find the position of the Sun, and the time when the photograph was made.

We can create more examples in the classroom. We only need a stick, a light source, a dark room and a wall. Varying the position of the stick (or the light source), we find a mathematical relation between the stick's position and the length of the shadow on the wall.

Students must first make a plan of how to carry out an experiment. They have to decide what are the independent and dependent variables, and which quantities should be kept unchanged, i.e., constant. Measurements should be tabulated and represented graphically. Students should try to understand what the results represent and how reliable they are. They should draw picture of the experiment in order to find geometric relationship between the stick and its shadow, and see how the values obtained through this relationship correspond to the measured values. Here they could include computer and use programs for dynamic geometry. If students worked in groups each group could demonstrate their work to other groups in the classroom. Many steps are possible and teachers could assess each of them separately. We used this approach in schools and found that some students are more confident with the experimental part while others are more comfortable with the graphic presentation of the data and the resulting mathematical relations. If students work in groups then they can

learn from each other and the teacher only needs to supervise their work and help them if they cannot successfully perform the experiment.

Through such examples it may be possible for the student to better understand connections between physical phenomena and their corresponding mathematical descriptions. We show some examples that are used in teaching seminars and how they are subsequently used in schools.

## 1. Introduction

In the course of field experience for students-future kindergarten and primary school teachers, one of the activities to be performed in the open air is observation of shadows.

First, shadows of vertical sticks are observed. Azimuth of shadows is measured. If the stick is fixed so that it casts no shadow, then it is directed toward the Sun; this enables students to determine the elevation angle of the Sun. If the two angles (azimuth and elevation) are measured every hour, then the changes of a shadow during the day are obtained and the corresponding graphs can be drawn at the end of the day. Equally interesting is observing shadows every month on the same date and at the same hour.

In the framework of the compulsory student teaching in the kindergarten and in the first classes of the primary school students teach children to observe shadows. Their task is to observe what children are doing and to direct them to do systematic observations of shadows.

What are children doing while observing shadows? They try to step on them, get rid of them, come in front of them. If standing on asphalt surfaces, they may make contours of shadows and mark where they are standing. They should repeat the observation after one or two hours. Children note that the position, magnitude and also the shape of shadows have changed. Such initial observations can serve as introduction to various measurements and determination of relationships between the height of the Sun, position of objects, and their shadows.



Figure 1: A girl observing her shadow.

It is also interesting to observe different kinds of shadows, for example shadows of triangular form. As they can be observed only under special conditions, it is best to show students a photo and give them the task to plan and perform an experiment which shows that under certain conditions all objects cast triangular shadows.

## 2. Large triangular shadows

Mountains in Slovenia have various forms. Some of them have the form of a sharp peak (a cone); others are rounded or scalloped. Sometimes, if we are on the top of a mountain during an early or late sunny day, we can see the shadow cast by the mountain on which the sun is shining at a low angle. If we know the landscape well, we can determine which place the shadow of the top of the mountain points to.

On Fig. 2, a photo of the shadow cast by the mountain Špik is shown. It was made on the 12th of November 2005 at 3:07 p.m. However, the photographer Andrej does not remember if he had switched the time from the summer time to winter time on the photo timer. Can we establish the right time at which the photo was taken from data available over the Internet?

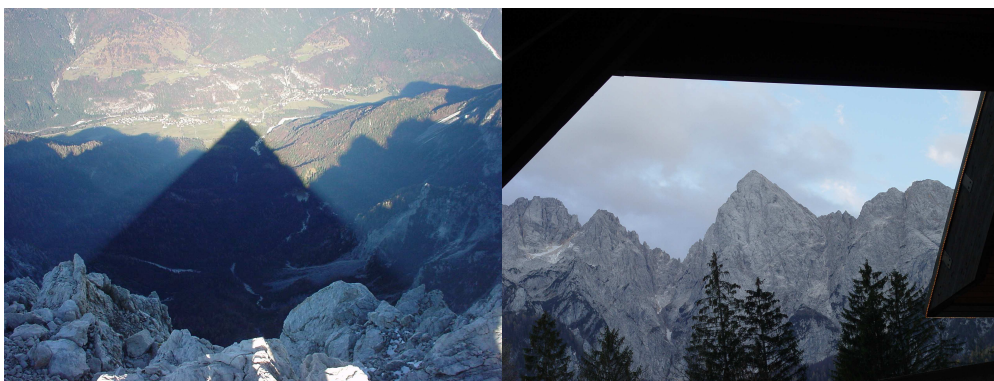


Figure 2: The shadow of Špik.

Figure 3: View of the mountain Špik.

The azimuth is the angle whose first ray is directed towards the north, and whose second ray is directed towards the shadow formed by the top of Špik, with the vertex being at the observer on the top of Špik. We must know the orientation of the angle; the azimuth of the east is  $90^\circ$ . From the map of Slovenia we find that the azimuth of Špik's shadow on the photo is  $21^\circ$ .

The calculation of the time when the photo of Špik has been taken can be simplified if we do not need high precision. In one day, the Earth moves by approximately  $1^\circ$  on its way around the Sun. Therefore, we can say that in the

time span of a few hours the incident angle of the sun's rays with respect to the Earth's axis does not change. Every hour, the Earth makes an angle of  $15^\circ$  around its own axis. Let us draw a region at the geographical latitude  $46^\circ$  together with the horizontal plane and a plane parallel to the equatorial plane.

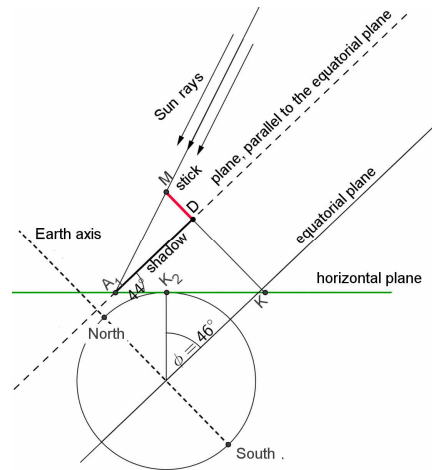


Figure 4: Horizontal plane, equatorial plane, and the construction of the shadow on the plane, parallel to the equatorial plane.

To draw a geometric construction of these planes, we make use of the computer program for three dimensional geometry, Cabri 3D.

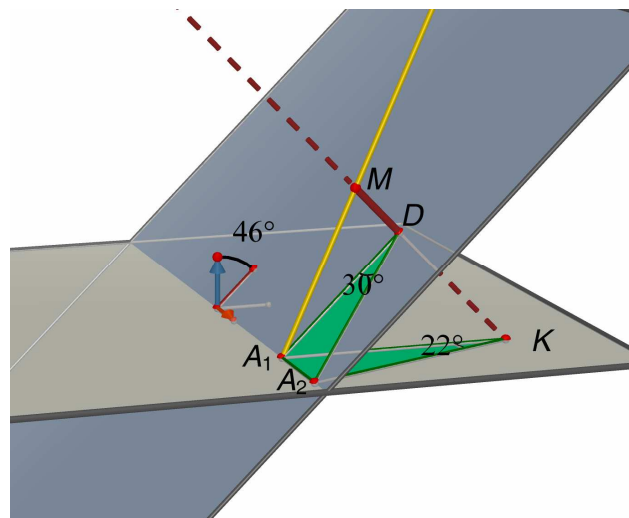


Figure 5: Rotation of the shadow in two hours. The yellow line shows the direction of the sun rays; the dashed line points toward the north.

Put a stick (MD) perpendicular to the plane which is parallel to the equatorial plane (shown in blue in Fig. 5). Since we know that the photo was made about two or three hours after noon, we draw the shadow from noon on.

The shadow that we observe in the plane, parallel to the equatorial plane, is rotated by  $30^\circ$  in two hours (green region in Fig. 5) and its length does not change. But what is the rotation angle in the plane where we actually observe the shadow (marked light gray in the Fig. 5) and which is not parallel to the equatorial plane? The rotation angles of the shadow are different in the equatorial plane and in our plane. From the computer calculations, we find that the angle by which the shadow is rotated in our plane is approximately  $22^\circ$ . (It can be easily seen that the quotient of the two angles is equal to the cosine of the angle between the planes.) We found from the photo that the top of the shadow had moved by approximately the same angle (the azimuth angle was  $21^\circ$ ). This means, that the photo was made at about 2 p.m.

Of course, one can object arguing that the stick was perpendicular to the equatorial plane, not to our plane. However, we are interested only in the top of the mountain, and for this reason only the endpoint M of the stick is of interest to us, irrespective of the orientation of the whole stick. We already found out that, on the equatorial plane, the shadow of the point M is rotated by  $30^\circ$  around D in two hours, while on the horizontal plane, the corresponding angle around K is  $22^\circ$  (Fig. 5).

We may therefore conclude that in two hours after noon, the shadow moves by  $22^\circ$  also for a stick, perpendicular to the horizontal plane. (Note, however, that the length of its shadow changes.)

In Fig. 2, some very bright light rays can be seen at the bottom edge of the photo which indicate that the sun was just setting "behind" Špik. This makes it possible to estimate the elevation angle of the sun rays. From the map we measure the distance from the top of Špik to the top of its shadow. On the map, the distance is found to be 8.8 cm which, taking into account the scale, is  $s = 4400$  m in reality. The altitude of the village (Gozd Martuljek) where the top of the shadow lies is 755 m, and the height of Špik is 2472 m. The difference of these two altitudes  $h_1$  and the elevation angle to the horizontal plane are, respectively,

$$h_1 = 2472 \text{ m} - 755 \text{ m} = 1717 \text{ m}, \quad \text{tg } \alpha = h_1/s, \quad \alpha = 21^\circ.$$

At noon, the elevation angle of the sun rays was about  $30^\circ$  (as found on the Internet), but the photo was taken later, and the elevation of the rays was smaller.

### 3. Are there other mountains which cast triangular shadows?

We could maintain that the shadow of Špik is triangular because of the form of the mountain. Can objects of different shapes make triangular shadows during the day? The answer is positive. It is only necessary to make observations of shadows at the right time and at the right place. We do not need to go far, we can observe them on a (horizontal) table or on the ground near a window or glass door.

Let us observe shadows on a horizontal plane (Figure 6).

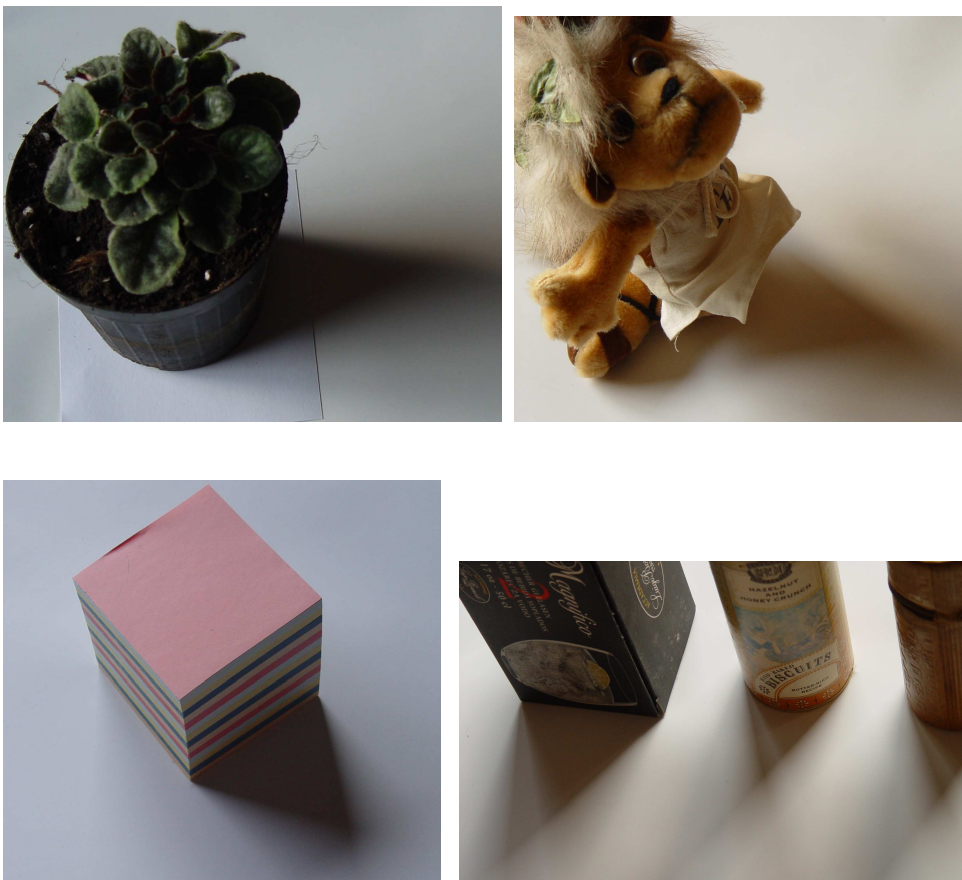


Figure 6: Triangular shadows formed from the light of a window of a flowerpot, of a TeX's mascot lion, of a cube and of two cylinders and a solid block. In the last photo, umbras and penumbras are clearly seen. Photos were taken early in the morning, when the sun was just rising from behind a roof which can be seen far away through the window. Shadows can be conveniently observed also using a computer screen as a light source if we make it a light white surface. However, in this case taking photographs is more difficult. The umbra is the darkest part of the shadow (the light source is completely occluded). The penumbra is the region in which a portion of the light source is obscured by occluding body.



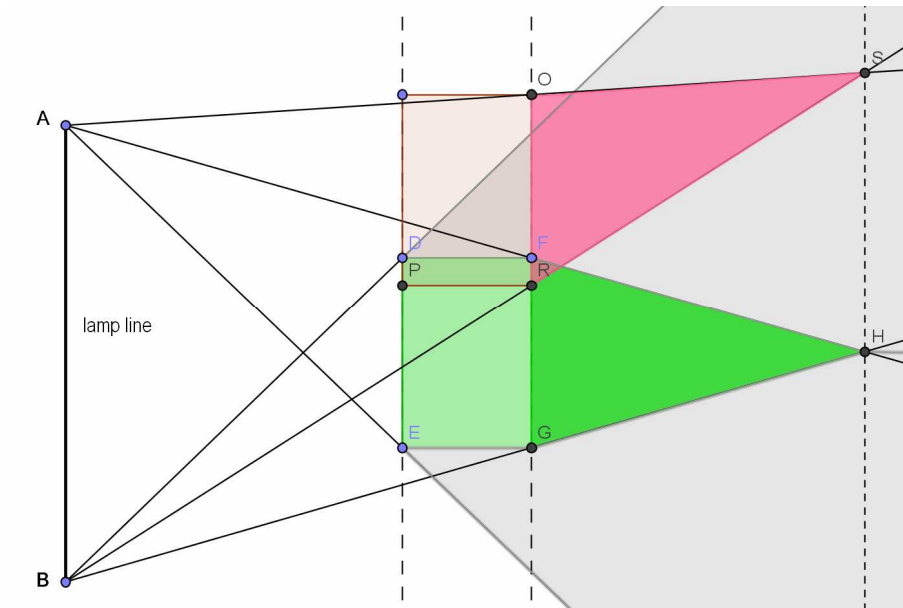


Figure 7: The line segment AB represents an extended lamp. The shadows of the two objects (with rectangular cross sections) are painted in the same color as the objects. The gray color area shows the penumbra of the green object. If we move the object along the line, parallel to the light source AB, the ends of the triangular shadows also move along a line parallel to AB.

Let the lamp have the form of a line (Fig. 7). We first consider the shadow of an object with rectangular cross section. We note that moving the object along the line, parallel to the lamp line, the altitude of the shadow triangle (= the straight line perpendicular to the side along the object and going through the vertex opposite to it) is constant. We can prove this on the basis of the similarity of triangles.

Let us divide the triangle ABS into the trapezoid ABRO and the triangle OSR. Let us denote the height of the trapezoid (= distance between the lamp and the back of the object) by  $v$ , and the altitude of the triangle by  $v_1$ . Let us also write  $a$  for the length of segment AB, and  $b$  for the side of the rectangle RO. From the similarity of triangles, it follows

$$a/(v + v_1) = b/v_1, \quad v_1 = bv/(a - b).$$

Consider the second triangle ABH. The trapezoid ABGF has the same height as ABRO ( $v$ ). Let  $v_2$  be the altitude of the triangle FGH. As before we have:

$$a/(v + v_2) = b/v_2, \quad v_2 = bv/(a - b).$$

This proves that the height of the shadows is constant.



We now investigate what happens to shadows when we change the distance between the lamp and the object. This time, let us take an object with a circular cross section.

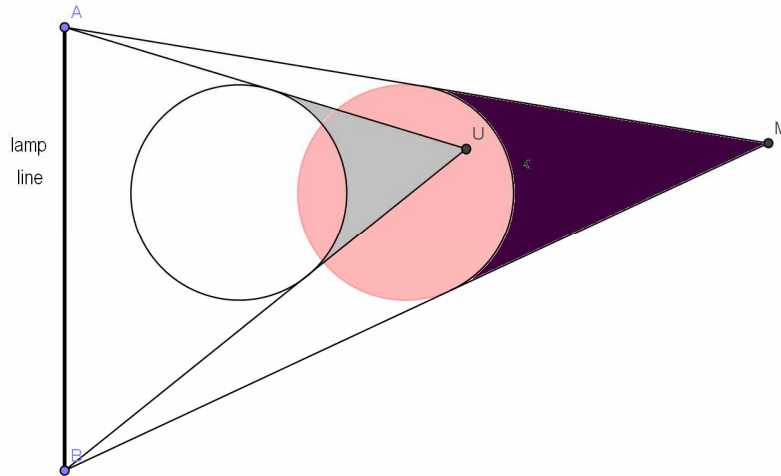


Figure 8: The shadow of an object with a circular cross section which we move closer to the light source. The height of the shadow is getting smaller. This is true also for the case when we would increase the size of the light source (the segment AB).

We see that the height of the triangular shadow depends on the distance from the light source, the size of the basic plane (cross section) and the size of the light source (segment AB).

We mentioned only the cross section of the object, without considering its height.



Figure 9: Shadows of two cylinders with the same cross section and different height. The triangular shadows are the same. On the right photo, these two cylinders are put next to each other. The shadow is still triangular. We conclude that the height of the object does not influence the height of the triangular shadow.

Considering shadows of two cylinders of different height (Fig. 9), we see that the height of the triangular shadows is equal for both cylinders.

However, when a direct sun light is incident on an object, the shadows are not triangular any more. The rays in the sun light are parallel and the form of the shadow cast by a rectangular block on a horizontal plane is a parallelogram. The same is true for a cylinder. Other objects make shadows of different shapes. In addition, the height of the shadow depends on the incident angle of the sun rays and the size of the object. The reader is invited to perform experiment by him-/herself.

We conclude that, in appropriate conditions, the shadows of mountains can be triangular, irrespective of the shape of a mountain. Some nice pictures of this kind can also be found over the Internet.

#### **4. Conclusion**

We started observing shadows of vertical sticks, got acquainted with the azimuth and the elevation angles of the Sun, and found how these two angles determine the magnitude and position of a shadow. We performed a simple calculation to determine the time at which a photo of a mountain shadow was taken. In the end, we found out that objects of any shape can cast triangular shadows which anyone can observe also at home, if only he/she pays attention to it.

This way all children (students) can be included in various activities irrespective to their previous knowledge. At the same time, activities with computer can be added which for many students are a good motivation aid. On the other hand, this kind of activities make students get used to observe natural phenomena more attentively and they show how to plan experiments in order to explain these phenomena.

#### **References:**

1. John A. Adam, *A Mathematical Nature Walk*, Princeton University Press, Princeton and Oxford, 2009, pp. 189-191.
2. Paul G. Hewitt, *Conceptual Physics*, Tenth edition, Addison Wesley, 2006, pp. 503-505.
3. <http://en.wikipedis.org/wiki/Umbra> (visit June, 11. 2010).

## Electromagnetism - seeing and calculating

Krzysztof Rochowicz, Andrzej Karbowski, Krzysztof Służewski, Grzegorz Karwasz  
University Nicolaus Copernicus, 87100 Toruń, Poland  
kroch@fizyka.umk.pl

### Abstract:

In the frames of a wider didactical path we propose some experiments in electrostatics and magnetism, tightly related to the solved problems in Physics available on the internet ([www.physicstasks.eu](http://www.physicstasks.eu)). These materials form an important step towards understanding electromagnetism both experimentally as conceptually.

Teaching electromagnetism is not an easy task. In Polish basic-level Physics curriculum for instance, this section is practically neglected. While present in the extended course, it is often excessively formalized and not sufficiently illustrated with simple examples. Left-hand rule of induction and Oersted experiment dominates over the concept of energy conservation (i.e. Faraday- von Neumann- Lenz principle) or the continuity of magnetic lines (i.e. the inexistence of magnetic monopoles, or in other words difficulties in defining magnetic field lines in the same way as the electric lines). Some textbooks reduce magnetism to the relativistic explanation by Einstein, not giving a single bit of information on permanent magnets, coils, wires and so on. On the other hand, precise calculations of two interacting permanent magnets is not trivial, either [1].

In our previous collaborations at the EU level [2] we have developed some experiments illustrating Lenz law, magnetic interactions qualitatively and quantitatively, diamagnetism, Earth's magnetic field [3] and electrostatics [4]. The experimental kits (40 experiments) are under didactical testing in upper secondary schools all over EU.

In present work we suggest some of experiments in electrostatics and magnetism, both with real objects as well in interactive ways [5], but now tightly connected with problems selected by our Czech collaborators from Prague University [6,7]. The motivation for our work was the lack of didactical path towards understanding electromagnetism. One of the key abilities which students should reach during physics education is to explain the experiment's result. Connecting it to the solved problems seems to complement one another.

The well known problem of two electrically charged balls [4] is illustrated in our Christmas glass balls experiment [5]. We hang the glass balls on the two tight cords (about 1 cm apart). The cords are connected to the poles (ends) of piezoelectric gas lighter (Fig. 1).

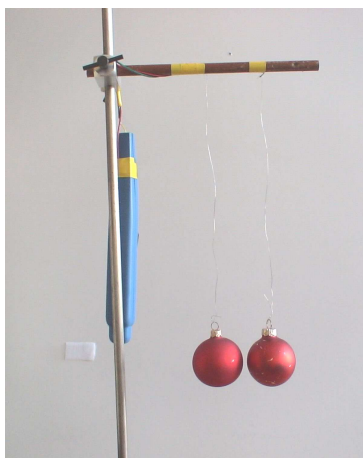


Fig.1 The experimental set used in Christmas balls experiment.

Switching the lighter on, we observe the balls attracting one another. We can easily determinate the size ( $r \sim 2$  cm) and the mass ( $m \sim 5$  g) of the balls. It is now possible to estimate the force needed to deviate the ball (for the length  $l \sim 20$  cm and the angle  $\alpha \sim 2.5^\circ$  we obtain  $F \sim 2.5$  mN). From the Coulomb's law we derive the charge of each ball,  $q \sim 10^{-8}$  C. We can now study the more complicated problem, such as two balls on a thread immersed in benzene [6]. Solving the problem after seeing the experiment is much easier and more interesting.

Interaction of a magnetic-dipole coil with the static magnetic field [7] forms the basis of another simple experiment [8]. Usually this experiment is done with a long dipole magnet. We perform it using a big neodymium magnet. Using the PASCO force sensor we can measure the interaction force (Fig. 2).

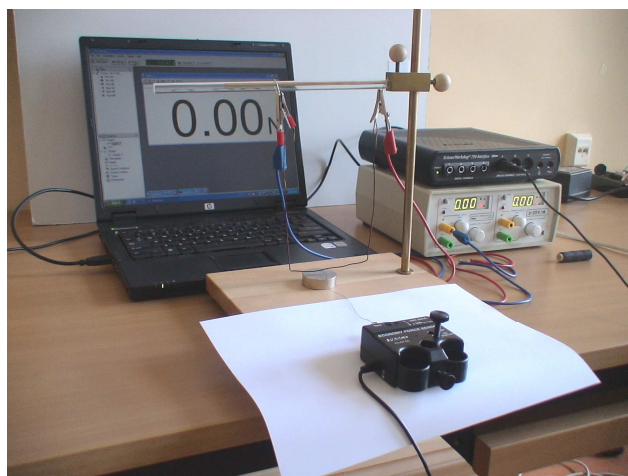


Fig.2 The experimental set used in the experiment on the interaction of a magnetic-dipole coil with the static magnetic field.

For the current  $I = 1$  A we have measured  $F = 0.01$  N. Putting the length of a conductor  $l = 0.1$  m we can estimate the magnetic induction  $B \sim 0.1$  T, which is in good agreement with the real value.

We would also like to note the experiment in which we measure the fall time of the neodymium magnet inside a copper tube. In order to calculate it, some assumptions on the geometry of the experiment (the thickness of wall tube, the tube diameter, electrical conductivity of copper) are needed. However, this simple experiment can be used by requiring students to predict trends from limited evidence [9].

The real experiments are very important and useful for pupils in secondary school. Taking it into account we propose to use the active and effective methods of teaching, in which simple experiments on magnetism and electromagnetism can be introduced at a secondary school level. The set of experiments is a result of our work and we offer schools and teachers a collection of simple, thought-provoking (minds-on) physics experiments (see Fig. 3).

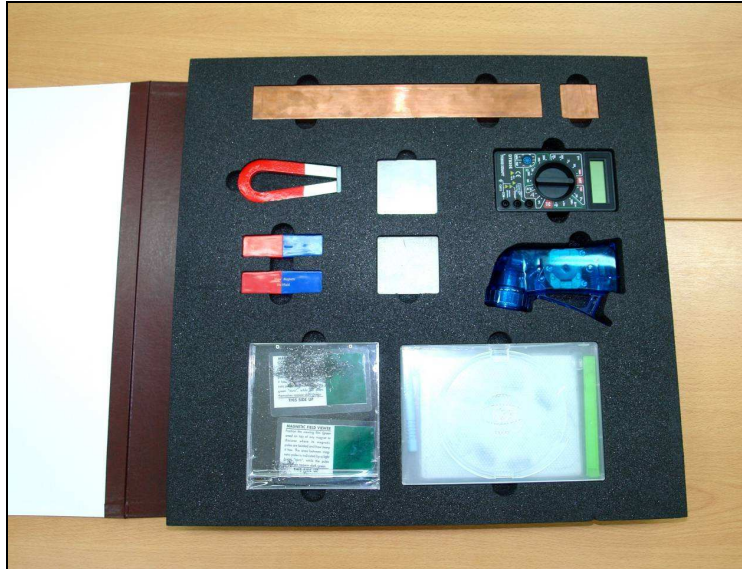


Fig. 3. The set of simple experiments on magnetism and electromagnetism.

Investigating the encountered phenomenon and doing own research with the provided materials and other sources we expect to improve motivation of students to learning physics.

### Summary and conclusions

We have showed only some examples of the interaction between the theory and practice. The two-direction interaction is highly stimulating: the experiment can enrich didactical aspects of solving EM problems and results of calculations can indicate the feasibility of didactical experiments.

### Acknowledgements

This work was supported by International Visegrad Fund grant no. 20910347.

### References

- [1] P. Mazzoldi, M. Nigro, C. Voci, Fisica, Elettromagnetismo, EdiSES 2000, p. 227
- [2] G. Karwasz, A. Karbowski, K. Służewski, R. Viola. M. Gervasio, M. Michelini, Discovering Electromagnetic Induction: Interactive Multimedia Path, Int. Work. on Multimedia in Physics Teaching and Learning, 14<sup>th</sup> Edition, 23-25.09.2009, Udine, Europhys. Conf. Abstract Booklet ISBN 2-914771-61-4, p. 48
- [3] G. Karwasz and MOSEM collaboration, 40 experiments in Electromagnetism, [http://dydaktyka.fizyka.umk.pl/TPSS/zestaw/Experimental\\_set.pdf](http://dydaktyka.fizyka.umk.pl/TPSS/zestaw/Experimental_set.pdf)
- [4] A. Okoniewska, G. Karwasz „Doświadczenie (Coulomba) po choinkę, (Coulomb experiment under Christmas tree), Foton 83 (Zima 2003), p. 55  
<http://dydaktyka.fizyka.umk.pl/zabawki/files/zrodla/choinka.html>
- [5] A. Karbowski, P. Miszta, G. Karwasz, Multimedia textbook on electromagnetism, <http://dydaktyka.fizyka.umk.pl/TPSS/flashFizyka/Elektromagnetyzm.swf>
- [6] Z. Koupilová et al., Two balls on a thread immersed in benzene, Collection of Solved Problems in Physics [http://www.physicstasks.eu/uloha\\_281](http://www.physicstasks.eu/uloha_281)
- [7] Z. Koupilová et al., Current carrying wire in magnetic field , Collection of Solved Problems in Physics [http://www.physicstasks.eu/uloha\\_287](http://www.physicstasks.eu/uloha_287)
- [8] M. Sadowska, Interaction between magnet and a coil, Instructions for students, MOSEM Project, [http://mosem.fizyka.umk.pl/pliki/opisy/6\\_6\\_eng.pdf](http://mosem.fizyka.umk.pl/pliki/opisy/6_6_eng.pdf)
- [9] G. Ireson, J. Twidle, „Magnetic braking revisited: activities for the undergraduate laboratory” (2008), European Journal of Physics, 29, 745.

# Development of Representational Competence via Cognitively Activating Tasks for Physics Experiments

Jochen Scheid<sup>1</sup>, Andreas Müller<sup>2</sup>, Wolfgang Schnotz<sup>3</sup>, Rosa Hettmannsperger<sup>1</sup>,  
Jochen Kuhn<sup>4</sup>, Sibel Telli<sup>1</sup> & Patrik Vogt<sup>1,4</sup>

University of Koblenz-Landau, Campus Landau, Germany:

<sup>1</sup> DFG-Graduate School “Teaching and Learning Processes”

<sup>3</sup> Department of General and Educational Psychology

<sup>4</sup> Institute for Science Education/Physics Education unit

University of Geneva, Switzerland:

<sup>2</sup> Institute of Teacher Education and Faculty of Sciences / Physics Department

## Abstract

Science education literature clearly shows that various mental representations and their interplay are vitally important for a proper understanding of scientific experiments, phenomena and concepts (Gilbert & Treagust, 2009). Additionally, research results indicate that students remember and understand little by doing own experiments (Harlen, 1999) as well as watching the lecturer doing experiments (Crouch, Fagen, Callan, & Mazur, 2004). There is an increasing body of evidence, however, which shows that learning about and from experiments *can* be enhanced by proper cognitive activation such as the predict-observe-explain sequence (Kearney Treagust, Yeo, & Zadnik, 2001; Crouch et al., 2004).

In general, external representations are used as problem solving tools in physics. In particular, secondary level I students have problems to work correctly with these external representations, e.g. to translate one type of representation in another type. Therefore, the purpose of the present study was to develop and investigate cognitively activating tasks by focussing on the essential role of representations in understanding of experiments.

A study (secondary level I, two classes,  $n = 59$ , domain: ray optics, duration 135 min.) with quasi-experimental, one-factorial design (with vs. without explicit representational exercises: completing, correcting, adapting & mapping of representations) was carried out. Dependent variables were conceptual understanding and representational competence. The treatment with representational analysis tasks (RATs, such as completing, correcting, adapting & mapping of representations, and typically based on two or more forms of representations) is described, as well as the operationalization of the target variables.

Results of an ANCOVA show no treatment effects on conceptual understanding, but a considerable effect on representational competence ( $p < .001$ ;  $\omega^2 = .22$ , large effect size<sup>1</sup>), which is discussed in view of existing theory background. In sum, a relatively short intervention can lead to a significant and practically important improvement of representational competence. Limitations and perspectives of the present study are discussed, including an outlook on future research.

## 1. Introduction

For a proper understanding of scientific experiments, phenomena and concepts, various mental representations and their interplay are vitally important (Gilbert & Treagust, 2009). However, it is not enough to know only one type of these representations at a time such as to

---

Corresponding author: [scheid@uni-landau.de](mailto:scheid@uni-landau.de)

<sup>1</sup> According to the conventional categorization, cf. Cohen (1988)

handle an equation or draw and interpret a graph. It is a salient feature of scientific understanding that it can only occur when students have the ability to build meaningful connections between different representations (Mayer, 2005).

In particular, the understanding of a physics experiment and its interpretation is dependent on a meaningful understanding of several relevant representations and their connections with each other. However, research shows that students often remember and understand little by doing their own experiments (Harlen, 1999) or watching the lecturer's experiments (Crouch et al., 2004). Nevertheless, there is an increasing body of evidence which demonstrates that learning about and from experiments *can* be enhanced by proper cognitive activation as the predict-observe-explain sequence (Kearney et al., 2001; Crouch et al., 2004).

Extending this line of research, the present study aims to develop and investigate cognitively activating tasks by focussing on the essential role of representations in understanding of experiments.

## 2. Research background

Representational competence can be defined as the ability to generate and use different specific depictive representations or descriptions of a subject or a problem in a sophisticated way (Dolin, (2007). Various functions and benefits of representations in science (and mathematics) education are well known, in close parallel to their role in the disciplines themselves.

Devetak, Urbančič, Grm, Krnel, & Glažar, (2004) pointed out that science (i.e. chemistry) knowledge of students is fragmented, unless the pertinent representations are connected with each other. Therefore, students' drawings and annotated diagrams representing phenomena at the sub-micro level can provide insight into students' understanding at the macro level (Davidowitz & Chittleborough, 2009). More specifically, if students are able to build meaningful connections between representations, they can acquire a deeper understanding than it is possible by learning by words or pictures alone (Mayer, 2005). On the other hand, the necessity of the use of multiple representations imposes a high cognitive load experienced by students (Sweller, 2005). Cognitive schemata are very important building blocks for the development of expertise, because they may lower the cognitive load and set free mental resources (attention, short term memory). Thus, it is very plausible (but not well investigated) that cognitive schemata caused by cognitively activating tasks related to representations could help the student's understanding of science experiments with their underlying interplay of multiple representations and the particularly high cognitive load resulting from it.

The results reported so far, mainly related to chemistry education and educational psychology, seem transferable and adaptable to physics education. For example, Lee (2009) analyzed the usage of representations in 26 lessons in three physics classes on optics with secondary level I students. Almost 150 stances of representation usage were found, most often implicit and lasting on average less than three minutes. The most frequent source of representations was the teacher, followed by the textbook or curriculum materials. Less than ten percent of the representations were generated by students. This short, receptive and therefore implicit work with representations leads to obvious restrictions and difficulties for the learning process. For this reason, students lack cognitive activation and therefore they do not have the possibility to develop relevant cognitive schemata. Moreover, even in the physics courses at university level, students' representational competence is low (Saniter, 2003).

Scheid & Müller (2010) investigated in the domain of electrodynamics how preservice teacher students deal with representations in experiment related tasks. Qualitative analyses revealed that students were more skilled in solving tasks by descriptive representations even on a formal level (e.g. mathematical equations) than in solving tasks by depictive



representations (e.g. graphs). Moreover, the following difficulties were found even for descriptive representations generated by students: on a basic level, some students, for example, confused symbols for physical quantities with symbols for units (same symbol, but different meaning), showing a lack of conceptual understanding. The students tried also to establish connections between surface features (characters) without being aware what the representation (symbol) symbolizes. On a higher level, most students had difficulties fitting their knowledge into an integrated representation (i.e. a graph of entire time course of voltage vs. time in a self induction experiment), even though most of them showed a proper understanding of the most important elements of the phenomenon “induction” (such as  $U_{ind} = L \frac{dI}{dt}$  and correct application on an induction spark of a switch). Generally, even physics preservice teachers’ degree of representational competence in general and coherence in particular was low and had to be improved.

### 3. Rationale, Research Questions and Hypotheses of the Study

Concluding from the preceding section, there is an urgent need for further research and research based development of tasks on representations in science education. In particular, we better need to know, why students’ representational competence is so unexpectedly low and how it may impede learning from experiments. Accordingly, the rationale of the present study is to improve this situation by explicitly integrating representations in the teaching-learning-process. Specifically, it aims at designing and investigating cognitively activating tasks fostering students’ representational competence (e.g. the ability to translate different types of representations in each other and correct incoherent pairs of representations) and improving in this way the understanding of physics experiments. For the purpose of our investigation, we choose ray optics as representationally rich topic. On this basis, the study had the following research aims and questions:

1. Is it possible to test for representational competence with items which are curricularly valid for the chosen topic (ray optics)? To which degree are they reliable?  
Hypothesis 1: The working hypothesis of the study is that a valid and sufficiently reliable test of representational competence is possible.
2. What is the impact of the newly developed cognitively activating representational tasks on students’ conceptual understanding and representational competence in ray optics?  
Hypothesis 2: Based on the existing literature, we expect that an explicit focus on representation related, cognitively activating tasks lead to improved learning.

### 4. Materials and Methods

The topic was ray optics (image formation by a convex lens, a standard topic in German secondary level I). The sample comprised 59 students in two classes taught by the same teacher (23 boys, 36 girls, 8<sup>th</sup> grade of German gymnasium (similar to UK grammar school), age group 13 – 14 years; 4 students did not participate in one of two tests and were excluded from analysis). The total duration of the intervention was 3 lesson hours (in sum 135 min). Additionally, the pre- and post test demanded one class hour in each case.

The study had a quasi-experimental, one-factorial design. The instruction in the treatment group (TG) was based on tasks explicitly asking for *analysis* of various representational features (representational analysis tasks, RATs), such as completing, correcting, adapting & mapping of representations, and typically based on two or more forms of representations (see e.g. Figure 1); the instruction in the control group was based on traditional tasks, e.g. dealing



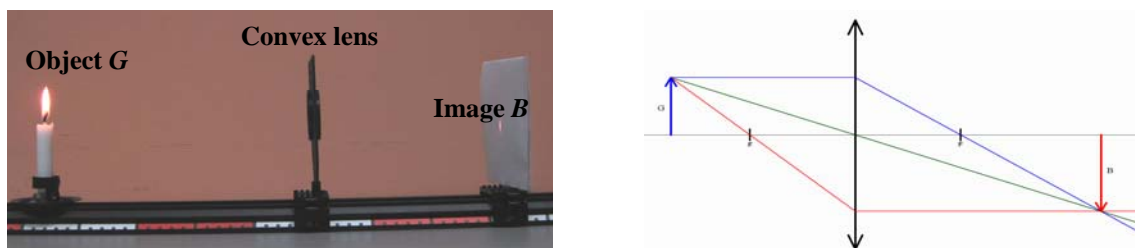


Figure 1: A realistic picture and a schematic drawing of a cognitive activating task for formation of image by a convex lens. Task type: mapping and correcting the schematic drawing; hint given: size of lenses and perspective of drawing do not matter.

with *construction* of ray diagrams only, and typically dealing with only one type of representation at a time.

Dependent variables were operationalized as follows: Conceptual understanding was measured by a concept test, which was designed as multiple choice test and consisted of 30 items. All the items had known misconceptions in ray optics as distractors, based on existing research (Goldberg, & McDermott, 1987; Wiesner, 1992; Reiner, Slotta, Chi, & Resnick, 2000). The reliability, as measured by  $\alpha_C$ , was .73.

Representational competence was tested with a 16 items test on completeness, consistency and coherence of domain specific representations. Development and validation (by expert rating) were carried out in cooperation between physics teachers and the local PER group. Reliability (and other characteristics) of this test will be reported below; more details about both tests will be reported elsewhere (Hettmannsperger, Scheid, Müller, Schnotz, Kuhn, Telli, & Vogt, 2011a).

Cognitive activation by RATs occurs if students think more often or more deeply about physics related representations, express them verbally and draw conclusions from them as would be the case without adequate instructional means. Figure 1 is an illustrative example of such task designed for the purposes of this study. This task is cognitively activating (according to hypothesis 2) because of three reasons: first, students were asked to analyze whether the realistic and the schematic picture belong to exactly the same experimental situation (which is not the case). Furthermore, they should identify and name the differences between the arrangements of optical items of both pictures. Second, the students had to correct the schematic drawing (in order to be equivalent to the realistic one). Third, students were asked to express verbally *why* and *how* they made the correction. In this way, students worked with three different types of representations (realistic picture, schematic drawing and words). In general, the “translation” between these three types of representations is a big challenge, to be explicitly and actively practiced by students using such a kind tasks. In particular, coherence between the three different forms of representations is established if they correspond in conjoint information (the pictures presented in Figure 1 are not coherent).

## 5. Results

Preliminary analyses showed that three items of the representational physics test had to be changed before using them in further studies. Item difficulties of the residual test are .32 - .56 ( $M = .41$ ,  $SD = .13$ ). Corrected scale correlation is .42-.56 ( $M = .50$ ;  $SD = .08$ ) and  $\alpha_C$  is .75.

To answer the second research question, it is necessary to investigate main (and possible interaction) effects of the treatment on conceptual understanding and on representational competence. For this purpose an ANCOVA for each dependent variable was carried out.

For the concept post test score as dependent variable of the first ANCOVA, results showed an effect of the pre test score ( $p = .006$ ;  $\omega^2 = .12$ , medium effect size), but no effect of the RAT intervention compared to the control group.

For the representational competence post test score as dependent variable of the second ANCOVA, again an influence of the pre test score was found ( $p = .001$ ;  $\omega^2 = .19$ , large effect size). Moreover, in this case a considerable effect in favour of the treatment group could be established ( $p < .001$ ;  $\omega^2 = .23$ , large effect size).

## 6. Discussion and Outlook

The results indicate that the test is acceptable for further use, supporting hypothesis 1 as working assumption of the study.

On the one hand, the treatment group considerably ( $\omega^2 = .23$ ) outperformed the control group in representational competence, which partially confirms Hypothesis 2. This increases confidence that students' representational competence, as an important part of physics understanding in general, indeed can be supported by the kind of specific cognitive activation adopted in this study.

On the other hand, the RAT treatment had no effect on conceptual understanding, so this part of hypothesis 2 is not confirmed. A possible explanation is that the concept test assessed students' conceptual difficulties beyond the scope of the intervention, in a broader area of ray optics and beyond representational difficulties. So the results leave us with the message, that representational analysis tasks indeed can support representational competence, but that in order to overcome misconceptions, they have to be combined with other instructional measures (Hettmannsperger, Schnotz, Müller, Scheid, Kuhn, Telli & Vogt, 2011b).

In summary, a relatively short intervention in the area of ray optics (135 min. altogether) on the basis of representational analysis tasks can lead to a significant and practically important improvement of representational competence. Both the intervention and assessment are compatible with curricular and classroom conditions (at least in the author's country), in order to ensure practical applicability of the approach.

Further research is under way in order to increase sample size, statistical power, and in this way also the possibilities of a more detailed investigation of possible ATI effects, such as students' motivation and intelligence (verbal, numerical, reasoning) and academic level of pertinent school subjects (German language, physics and mathematics).

## References

- Cohen, J. (1988). *Statistical Power Analysis for the Behavioral Sciences*. Hillsdale, NJ: Lawrence Erlbaum.
- Crouch, C. H., Fagen, A. P., Callan, J. P. & Mazur, E. (2004). Classroom demonstrations: Learning tools or entertainment? *American Journal of Physics*, 72 (6), p. 835-838.
- Davidowitz, B. & Chittleborough, G. (2009). Linking the Macroscopic and Submicroscopic Levels: Diagrams. In John, K., Treagust, D. (Eds.). *Multiple representations in chemical education*. In models and modeling in science education. Volume 4, New York: Springer, p. 169.
- Devetak, I., Urbančič, M. W., Grm, K. S., Krnel, D. & Glažar, S. A. (2004). Submicroscopic representations as a tool for evaluating students' chemical conceptions. *Acta Chimica Slovenica*, 51, p. 799-814.
- Dolin, J. (2007). Science education standards and science assessment in Denmark. In D. Waddington, P. Nentwig & S. Schanze (Eds.). *Making it comparable. Standards in science education* Münster: Waxmann, p. 71-82, p. 77.
- Gilbert, D. & Treagust, J. K. (2009). Towards a Coherent Model for Macro, Submicro and Symbolic Representations in Chemical Education. In Treagust, J. K., Gilbert, D. (Eds.). *Multiple representations in chemical education*. In Models and modeling in science education, Volume 4, New York: Springer, p. 333.
- Goldberg, F.M. & McDermott, L. C. (1987). An investigation of student understanding of the real image formed by a converging lens or concave mirror. *American Journal of Physics*, 55 (2), p. 108-119.
- Harlen, W. (1999). *Effective teaching of science - A review of research*. Edinburgh: Scottish Council for Research in Education, p. 7.
- Hettmannsperger, R., Scheid, J., Müller, A., Schnotz, W., Kuhn, J., Telli, S., Vogt, P. (2011a). *A concept test and representational competence test in the area of ray optics* (manuscript in preparation).

- Hettmannsperger, R., Schnotz, W., Müller, A., Scheid, J., Kuhn, J., Telli, S., Vogt, P. (2011b). *Fostering representational and experimental competence considering students' prior knowledge in middle school physics classes*. Paper presented at the GIREP Conference in Reims, 2010. <http://www.univ-reims.fr/site/evenement/girep-icpe-mptl-2010-reims-international-conference/list-of-submitted-full-papers-for-proceedings,13181,22950.html>? (follow menu "posters"; access 11-09-29).
- Hoffmann, L., Häußler, P. & Peters-Haft, S. (1997). *An den Interessen von Mädchen und Jungen orientierter Physikunterricht. Ergebnisse eines BLK-Modellversuches*. Kiel: Leibniz-Institut für die Pädagogik der Naturwissenschaften (IPN) an der Universität Kiel.
- Kearney, M., Treagust, D. F., Yeo, S. & Zadnik, M. (2001). Student and Teacher Perceptions of the Use of Multimedia Supported Predict-Observe-Explain Tasks to Probe Understanding. *Research in Science Education*, 31, p. 589-615.
- Lee, V. (2009). Examining patterns of visual representation use in middle school science classrooms. *Proceedings of the National Association of Research in Science Teaching (NARST) Annual Meeting Compact Disc*, Garden Grove, CA: Ompipress.
- Mayer, R. E., ed. 2005. *Cambridge Handbook of Multimedia Learning*. Cambridge: Cambridge University Press.
- Scheid, J, Müller, A. (2010). Preservice teacher student's usage of representations in an *Electrodynamics course at university level*. Unpublished document.
- Reiner, R., Slotta, J.D., Chi, M.T. H. & Resnick, L.B. (2000). Naive Physics Reasoning: A Commitment to Substance-Based Conceptions. *Cognition and Instruction*, 18 (1), p. 1-34.
- Saniter, A. (2003). *Spezifika der Verhaltensmuster fortgeschrittener Studierender der Physik*. In Niedderer, H., Fischler H. [Hrsg.]. *Studien zum Physiklernen Band 28*, Berlin: Logos, p. 289.
- Sweller, J. (2005). Implications of cognitive load theory for multimedia learning. In Mayer, R. E. (Ed. 2005), p. 19-30.
- Wiesner, H. (1992). Verbesserungen des Lernerfolgs im Unterricht über Optik. Schülervorstellungen und Lernschwierigkeiten. *Physik in der Schule*, 30 (9), p. 286-290.

## Foucault dissipation of a magnet falling through a copper pipe studied by means of a PC audio card and webcam

Assunta Bonanno<sup>1</sup>, Giacomo Bozzo<sup>1,3</sup>, Michele Camarca<sup>1</sup>, Marisa Michelini<sup>2</sup>, Peppino Sapia<sup>1</sup>

1. Physics Education Research Group, Physics Department, University of Calabria – Rende (CS) – Italy
2. Physics Education Research Group (URDF), University of Udine – Udine – Italy
3. bozzo@fis.unical.it

**Abstract.** In this paper we describe an experimental learning path on the electromagnetic induction based on the original use of an Atwood machine to obtain a controlled fall of a cylindrical magnet. Two different experimental setup are used: *i*) magnet falling across a coil (allowing to quantitatively study the Faraday-Neumann-Lenz law directly); *ii*) magnet falling across a copper pipe. This last configuration allows to investigate complex induction phenomena, by quantitatively determining power dissipation due to Foucault eddy currents, arising in the copper as magnet travels through it. Both mechanical and electromagnetic aspects of the phenomenon are continuously and quantitatively monitored by a common personal computer (PC) equipped with a webcam, and a freely available specific software allowing to employ PC as an oscilloscope through the audio card. Measurements carried out when the various experimental parameters are changed provide a useful framework for a thorough didactic discussion of the conceptual knots related to electromagnetic induction. The proposed learning path is under evaluation in some high school, within the Project “Lauree Scientifiche” promoted by the Italian Department of Education.

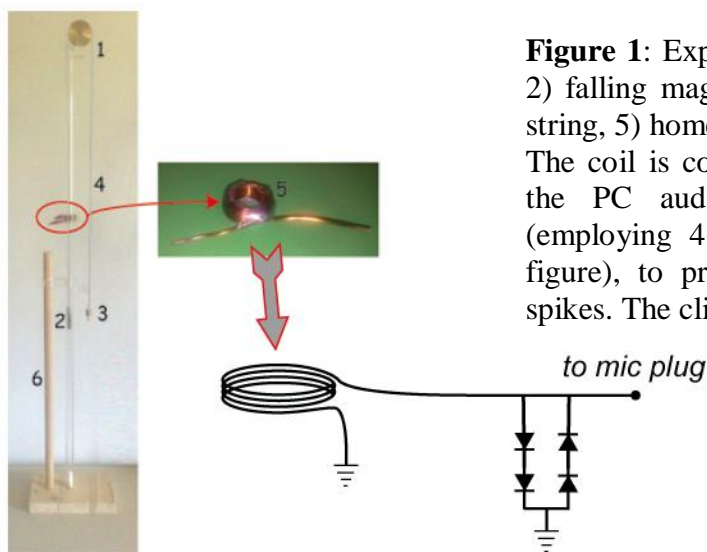
### 1. Introduction

Experimental activity plays a crucial role in Physics Education research. Many researchers stressed the importance of laboratory activities in learning process to increase student interest towards Physics and to create connections between science knowledge and everyday world experience (Bosio et al 2001, Bosio et al. 1997). Physics, in fact, is one of most difficult and boring school subject in spite of its many everyday applications (Bonanno et al. 2009b). Hands-on and minds-on activities can boost reasoning skills of students, through problem solving (Watts, 1983) and small group collaborative work (Heron 2008 Meltzer and Manivannan 2002, Coletta et al. 2007), as well as can effectively address the main student’s misconceptions if supported by appropriate learning/teaching strategies. Student interest is enhanced by on-line measurements, who offer a great support for experimental activity, since they allows to follow in real time the evolution of phenomena and to perform quantitative investigations (Gervasio et al. 2009, Bonanno et al. 2010). On-line acquisition systems, cheap and easy to use, capture student attention, allowing them to understand contents and to improve their own knowledge. However, although many not expensive on-line acquisition devices are commercially available, many schools had great difficulties to buy them. Furthermore, students cannot repeat these experiences at home, although they are easily made at school, because acquisition systems and data analysis software are not accessible for free.

On the other side, international literature has clearly identified the main difficulties encountered by learners in dealing with conceptual challenges of electromagnetic induction (Michelini and Viola 2007, Stefanel 2008, Bonanno et al. 2010), especially in facing the role of magnetic field flux and its time variation (Maloney 2001, Thong 2008, Galili 1997, Michelini 2008, Michelini 2009, Bonanno et al. 2010). In this context we proposed, in MPTL 2009 Conference (Bonanno et al.

2010), an on-line experiment in which real time graphs allow to face the conceptual knots relative to induced currents in electromagnetic phenomena, stressing the role of magnetic field flux variation. Anyway, during our didactic experimentation, we encountered several difficulties to introduce data acquisition system in schools because of their limited economic resources.

In this context, to overcome described troubles, we propose here an improved version of the experimental set up presented at the MPTL 2009 Conference, specifically designed to address some conceptual knots related to energy conversion (from mechanical to electrical), in addition to those concerning the role of magnetic flux variation in electromagnetic induction. The need for such an improvement has been suggested to us by our didactical experimentation, that has shown as conceptual knots related to energy conversion remained not fully clarified when the activity is specifically and exclusively focused on the magnetic flux variation (Bonanno et al. 2009a).



**Figure 1:** Experimental set up: 1) Atwood machine; 2) falling magnet; 3) counterweight; 4) inextensible string, 5) home-made coil, 6) support pole.

The coil is connected to the microphone plug-in of the PC audio card through a clipper circuit (employing 4 diodes 1N4007 connected as in the figure), to protect the card from possible voltage spikes. The clipper threshold is about 1.3 V.

## 2. Experimental set up with Atwood Machine

Proposed experimental learning path is based on an improved Atwood machine holding at one end a cylindrical magnet falling through a Plexiglas guide (Figure 1). This guide acts as a mechanical support for either a coil (Figure 2) or a conducting copper pipe through which the magnet can fall. In this way, two experimental configurations are possible, each aimed to address complementary conceptual knots concerning electromagnetic induction phenomena. A first configuration, featured by the guide surrounded with an induction coil, lets the magnet falling through the coil with controlled acceleration, so that a quantitative study of the induction law is directly allowed. In the other experimental arrangement the guide is surrounded by a copper pipe, whose length may be determined by the experimenter. In this way, kinematic study on the falling magnet permits the quantitative determination of power dissipation due to Foucault eddy currents (arising in the copper as magnet travels through it) and a consequent deeper insight into the complex induction phenomena. In both configurations, magnet acceleration may be set at wish by adjusting Atwood machine's counterweight.

One of the strengths of proposed experimental set up resides in the fact that both aspects of the phenomenon under investigation (*mechanical* and *electromagnetic*, as regards respectively, the *motion* and the *induction*) are continuously and quantitatively monitored through a common home PC, used as a low cost acquisition system. In fact, a freely available specific software<sup>1</sup>, permits to

<sup>1</sup> "Visual Analyzer Project", Tor Vergata University, Italy. On line at the URL: <http://www.sillanumsoft.org/>

employ the PC as an oscilloscope, via the audio card, so that the signal induced in the coil (while magnet crosses it) can be easily acquired. Similarly, the use of a webcam (640x480 pixel resolution, 25 frame per second – fps – speed), connected via USB to the PC, allows to perform the quantitative study of the motion, as elsewhere described by us (Bonanno et al. 2011).

The proposed activity provides students with the opportunity to perform quantitative experiments aimed, among other things, to: *i)* strengthen skills concerning data analysis; *ii)* get a deeper comprehension of important phenomena based on electromagnetic induction. In fact, the experiment with the coil is designed to guide to a correct analysis and comprehension of conceptual knots related to induced current, stressing the role of magnetic field flux variation. The experiment with the copper pipe set up allows students to quantitatively estimate Foucault force value and its dissipative effects. Both settings use free software available in internet or in all domestic PC so that students can utilize the PC audio card as a common data acquisition card, effectively supported by the simultaneous use of the webcam.

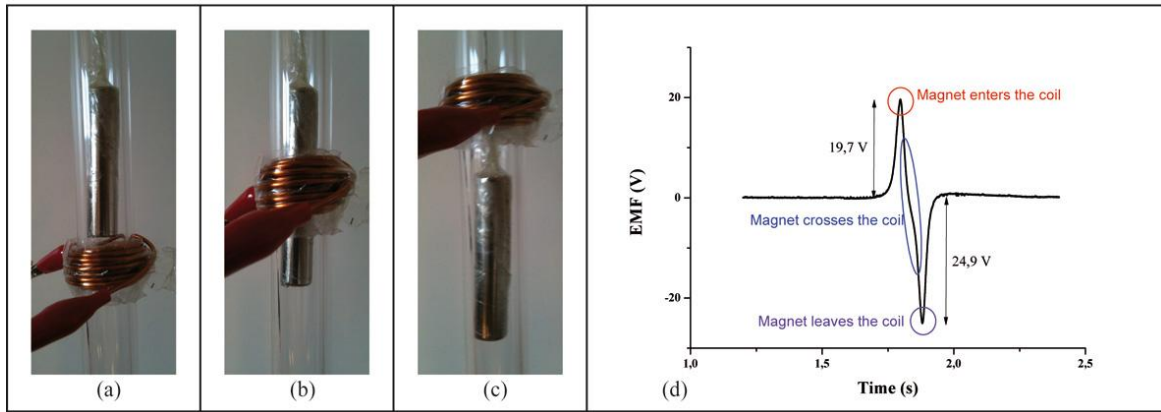
### 2. 1. Magnet falling through a coil

In this configuration (Figures 1 and 2) the magnet falls (with adjustable acceleration) through a coil and the electric signal induced in it is acquired and digitized using the audio-card-based acquisition system previously described. In this way, the Faraday law may be quantitatively studied by analyzing the Electromotive Force (EMF) as a function of time. As can be seen in Figure 2, when the magnet approaches to the coil, there is an increasing magnetic field flux and the induced current produces a magnetic field opposing to this increase, so that a repulsion will be produced between the magnet and the coil. As magnet enters the coil (Figure 2a), a peak is observed in the signal since the magnetic field is stronger at the poles. Until the second pole has entered the coil (Figure 2b), the magnetic field flux through it is nearly constant. Consequently in this temporal interval the induced tension almost vanishes. When the second pole crosses the coil (Figure 2c), there is a decrease in the magnetic field flux; therefore the induced tension is sign-reversed with respect to the previous situation.

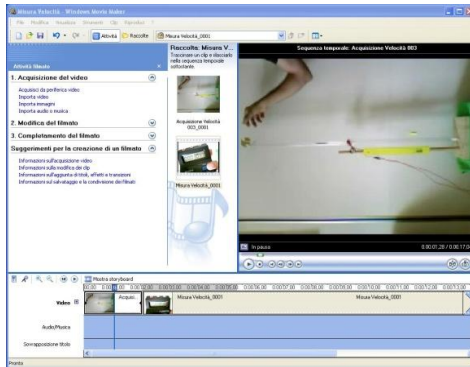
It's very interesting to observe the difference between modules of peak amplitudes (Figure 2d) when the coil is crossed by, respectively, the bottom or the top pole of the magnet. In fact, since magnet's motion is uniformly accelerated, the magnet entry speed is smaller than the exit one and, consequently, magnetic field flux variation at the way in of the coil is slower than at its way out.

The software we used allows to perform analysis of the electrical signal in a very simple, though didactically significant, manner. For example, proposed method permits to investigate the dependence of the peak amplitude and width on the magnet crossing-speed, and so on fall height. In this context, we propose to perform this type of analysis by using a video editing program (*Windows Movie Maker* – Figure 3) available in all domestic PC. The video acquisition by a webcam permits to analyze the time evolution of the magnet position and speed through the video frames saved as snapshots (Bonanno et al. 2011).

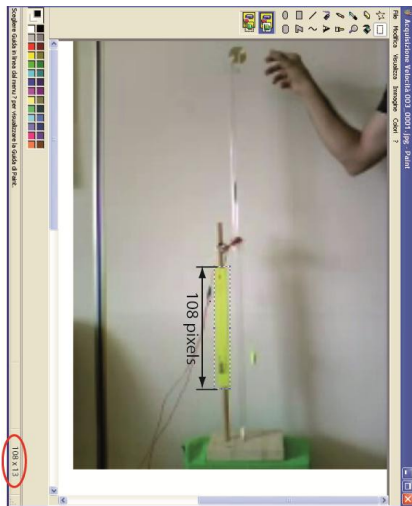
*Movie Maker* video acquisition captures a series of images (frames) of the magnet falling motion in a fixed time interval. Analyzing the magnet distance from starting position, it is possible to derive empirically the system acceleration  $a$  by using the equation of uniformly accelerated motion  $x(t) = \frac{1}{2}a \cdot t^2$ . This allows to obtain the magnet speed (for each frame), according to the law  $v(t) = a \cdot t$ . We use a simple image editing program (like *Paint*) to estimate the distances traveled by the magnet in terms of pixel numbers (Figure 4). A fixed reference length included in all the acquired images can be used in order to convert distances from pixels to centimeters.



**Figure 2:** magnet enters (a), crosses (b), leaves (c) the coil. The graph (d) shows the difference between modules of peak amplitude.



**Figure 3:** Data analysis using Windows Movie Maker.

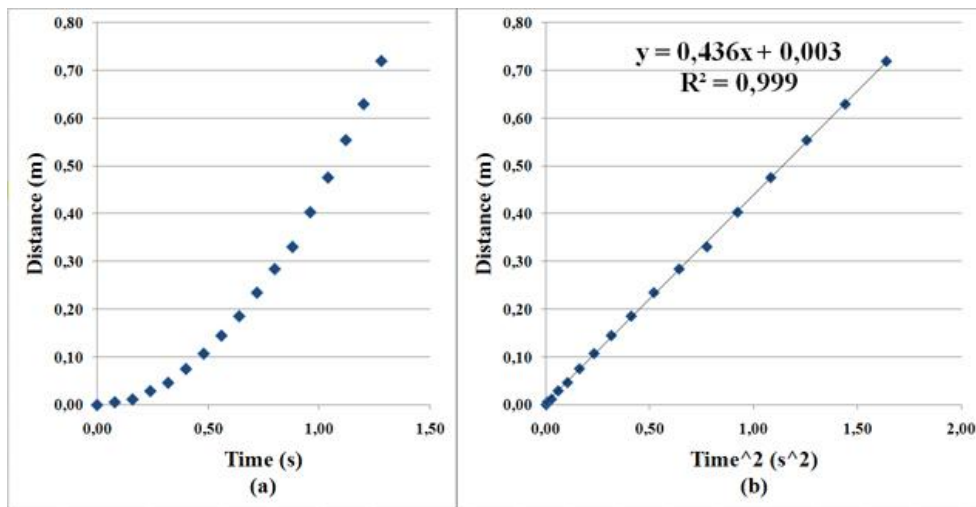


**Figure 4:** The yellow ruler sets the scale: its length (31.3 cm) corresponds to 108 pixels. Each pixel is equal to 0.29 cm.

As concerns the time scale, we point out that the interval between successive frames ( $1/25$  sec) can be easily deduced from the webcam rated frame-speed (25 fps). This nominal time step has been checked by taking a movie of a running digital chronometer and then verifying that the difference between the times marked by the clock in successive frames equals  $1/25$  sec.



Plotting the distance traveled by the magnet versus time, it's possible to observe a parabolic trend (Figure 5), where the parabola axis of symmetry is parallel to the distance-axis with the vertex at (0,0), as expected by equation of motion  $x(t) = \frac{1}{2}a \cdot t^2$ .

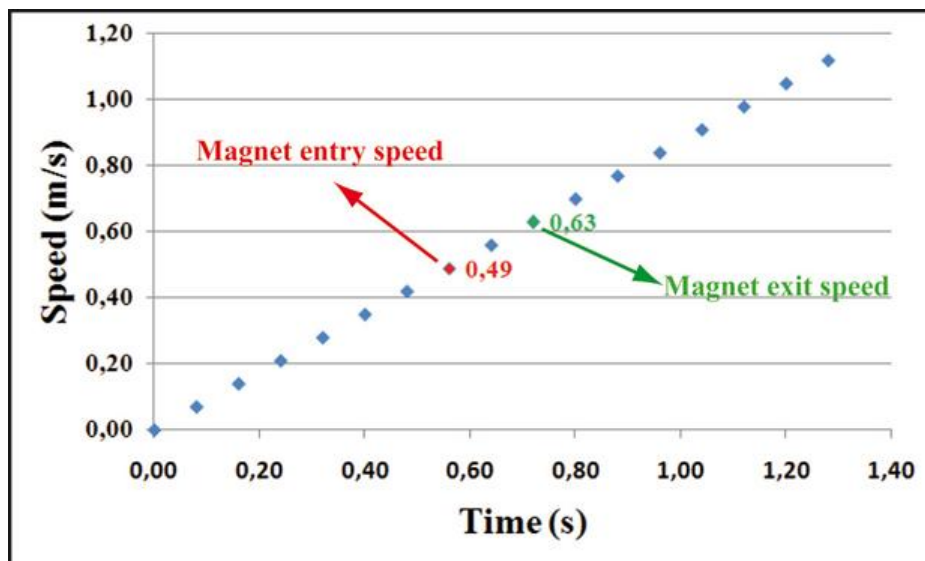


**Figure 5:** an example of (a) distance covered by magnet vs time and (b) distance covered by magnet vs time square.

We can obtain the acceleration from the distance-versus-time-square graph (Figure 5), where line slope is equal to  $\frac{1}{2}a$  (in this example, experimental acceleration value is:  $a = 0,872 \frac{m}{s^2}$ ).

This experimental value can be compared with the theoretically predicted one ( $a^{theor.} = 1,028 \text{ m/s}^2$ ), which can be easily obtained by elementary mechanics. Despite theoretical approximations (friction forces are neglected and momentum of inertia of a uniform disk has been considered), the experimental value is not too different from the theoretical one (about 15%).

At this point we can calculate the speed value for each instant, using the second equation of motion  $v(t) = a \cdot t$ , in particular when magnet enters or leaves the coil (Figure 6).



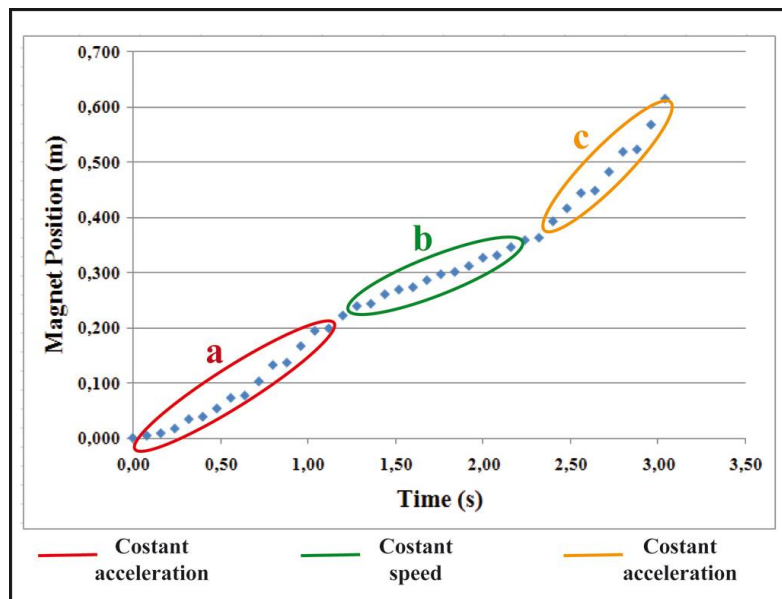
**Figure 6:** Magnet speed vs time obtained from the webcam video analysis. Marked points refer to the instants when magnet enters and leaves the coil.



## 2.2 Magnet falling through a Copper Pipe

The second experimental set up allows to highlight dissipative effects due to Foucault forces, by dropping a magnet through a copper pipe of various length<sup>2</sup>. This experiment allows, among other things, to achieve the didactical goal of clarifying the difference between accelerated motion and motion at constant velocity.

Figure 7 shows a typical experimental plot in which we can distinguish three different regimes: a) magnet falls with a constant acceleration (until it enters the copper pipe), b) magnet moves with constant speed through the copper pipe, c) magnet falls again with a constant acceleration (equal to that one of the first zone) as it exits the copper pipe.



**Figure 7:** Magnet position vs time; we can distinguish three different regimes: the first in which the magnet falls with a constant acceleration, the second in which the magnet moves with constant speed through the copper pipe, the third in which the magnet falls again with a constant acceleration.

## 3. Data analysis

A thorough analysis of data acquired with the proposed Atwood machine, in both described configurations, provides the context for addressing a series of educationally meaningful topics pertaining conceptual knots above mentioned. In the following we show some significant example of possible data analysis.

### 3.1 Magnet falling through a Coil

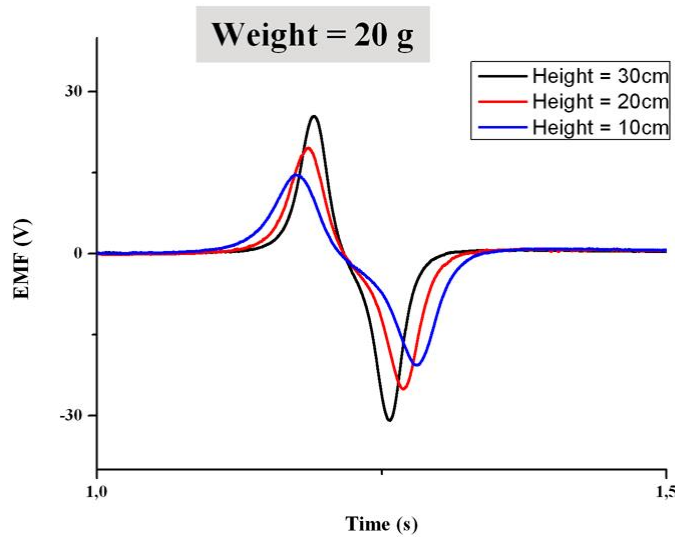
The software we used gives opportunities to perform the analysis of electrical signal induced in the coil, when it's crossed by the magnet. At this regard, an interesting observation is that when the falling height decreases peak amplitude decreases too, while peak width increases (Figure 8). The same behavior for peak amplitude and width is observed when Atwood machine's counterweight is increased, so that falling acceleration is correspondingly reduced (Figure 9). Both behaviors may be readily connected to the dependence on magnet crossing speed of inductive effects, since the time

<sup>2</sup> MOSEM<sup>2</sup> Project – online at the URL: <http://supercomet.no/gb/MOSEM2>

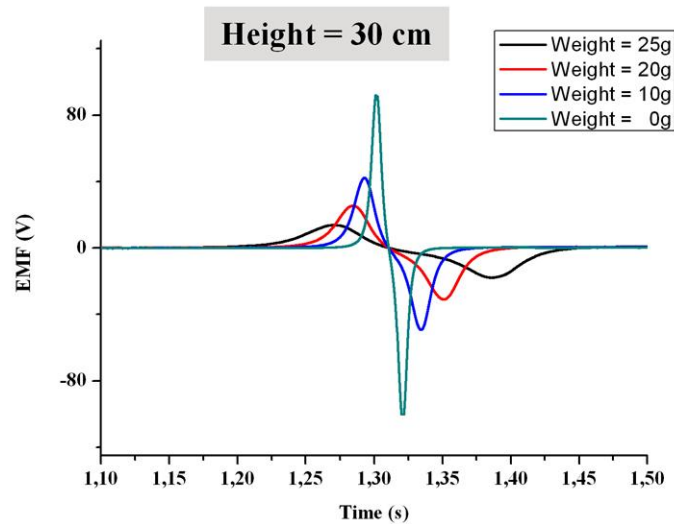
derivative of magnetic flux (which determines the signal amplitude) is directly related to magnet speed (and acceleration).

It follows from the above examples that a careful area analysis has a high educational value. Indeed, the fact that total area under the EMF-vs-time plot is zero has the deep meaning of the magnetic monopole non-existence. Such an analysis may be effectively performed by using Microsoft *Excel* software.

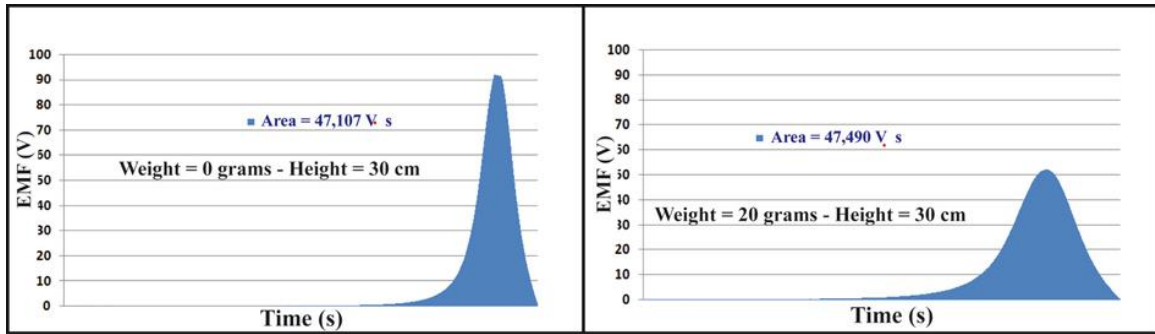
Figure 10 shows that the area under the positive (or negative) peak remains constant (with respect to the variation of falling height or value of counterweights), while Figure 11 highlights that total magnetic field flux variation is nearly to zero.



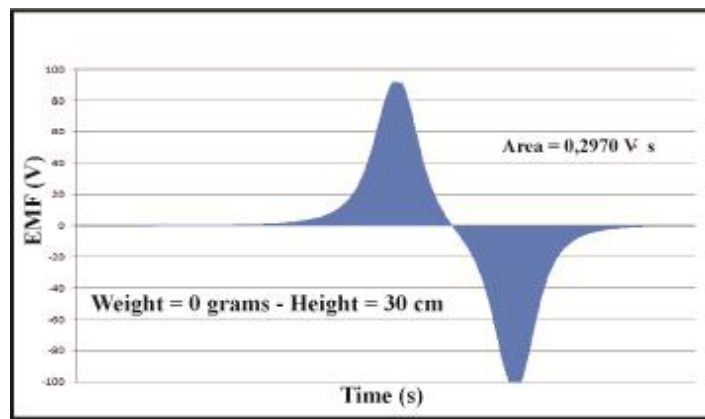
**Figure8:** When the falling height decreases peak amplitude decreases while peak width increases (using a fixed counterweight).



**Figure 9:** When the small weights increase peak amplitude decreases while peak width increases (at a fixed falling height).



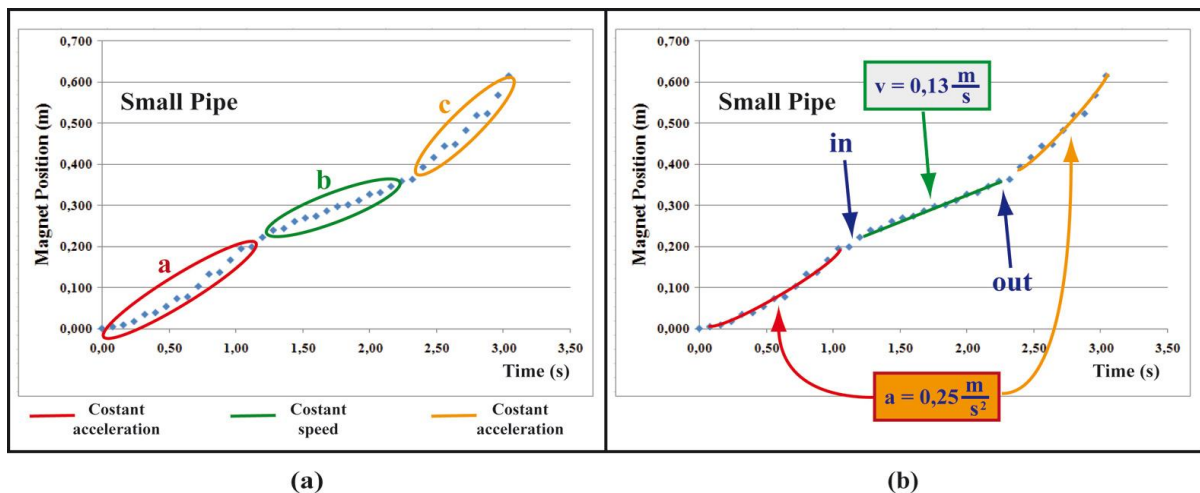
**Figure 10:** Area Analysis (flux variation analysis): the area under the positive (or negative) peak remains constant (with respect to the variation of falling height or small weights).



**Figure 11:** Total Area (i.e. total magnetic field flux variation) is nearly to zero.

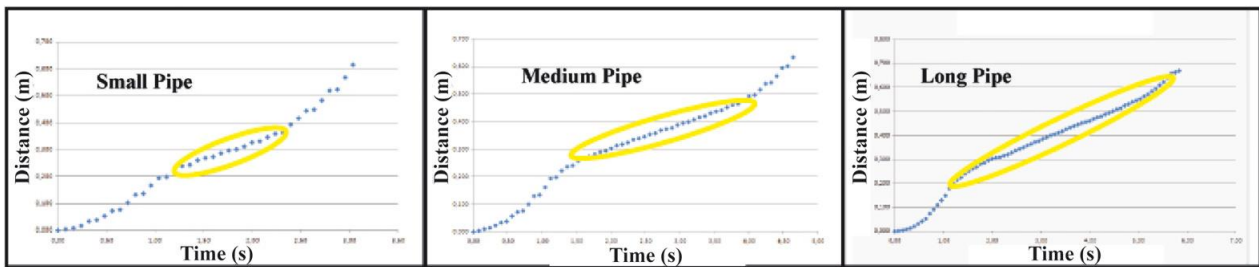
### 3.2 Magnet falling through a Copper Pipe

Finally, we can show the effects of electromagnetic induction by dropping a magnet through a copper pipe of various length in order to highlight dissipative effects due to Foucault force. Using this set up, we obtain the space-time diagram of the motion (Figure 12) and analyze magnet speed and time needed to cross the copper pipe.



**Figure 12:** typical trend of magnet position versus time in which we can distinguish three regimes (a); Through Movie Maker analysis it's possible to calculate speed value of second regime and acceleration value of first and third regimes (b).

Analysis of recorded motion movies, performed by employing *Movie Maker*, permits highlighting three motional regimes in the magnet's fall, allowing in particular to determine the speed value of second (uniform motion) regime, and acceleration value of first and third ones (Figure 12.b). In this way, we achieve the didactical goal of clarifying the difference between an accelerated motion and a motion at constant velocity. By using pipes of different lengths, we can observe that the various space-time diagrams are different only in second regime duration (Figure 13), i.e., that characterized by a constant falling speed, reached because of the dissipative effects due to the viscous-like force arising from the electro-dynamical interactions between the magnet's magnetic field and the Foucault eddy currents induced in the copper pipe by the passage of the magnet itself.



**Figure 13:** Comparison between trends of magnet position for different copper pipes shows that relative graphs are different only in second regime duration.

Finally we can easily determine the dissipative effect due to Foucault forces, when a stationary regime is reached. In fact, noting that in this regime the braking Foucault force is given by the difference between Atwood machine's weights, by appropriately substituting numerical values we easily obtain:

$$F_{Fouc} = (m_1 - m_2)g = 5,8 \times 10^{-2}N$$

Similarly, power dissipation due to Foucault force may be obtained multiplying by the falling speed:

$$P_{Fouc} = F_{Fouc} \cdot v = 7,5mW$$

#### 4. Conclusions

In this paper we presented an experimental learning path on the electromagnetic induction, based on an improved version of the Atwood machine. Two different forms of the experimental set up have been proposed. The first one contemplates the falling of a magnet through a coil and allows students to understand Faraday-Neumann-Lenz law. In the second set up the magnet falls through a conductor pipe and the energy dissipation due to Foucault eddy currents may be quantitatively investigated. Both settings use high tech (though low cost and widely available) technological devices, such as webcam and PC audio card, and employ freely available software allowing students to utilize PC as an oscilloscope. Proposed activity provides students the opportunity to perform quantitative experiments useful, among other things, in developing such a fundamental skills as data analysis capability and competence in instrument calibration. The activity, moreover, allows a deeper interpretation of an important phenomenon based on electromagnetic induction, as the Foucault eddy currents. Real time graphs of time depending phenomena play a central role in this didactical activity, focusing students attention on the role of several parameters (coil number, falling height and employed weights) characterizing the Atwood machine. In this regard, we stress the advantage of on-line acquisition, also from a didactical point of view, since it allows

students/experimenters to have an immediate feedback on the effects of parameter variation. Moreover the brainstorming discussion showed how pupils finally and successfully linked induced current to the magnetic flux variation through the coil. A typical student observation was: “current appears when spaghetti number through the coil increase or decrease in time”, where “spaghetti” obviously are magnetic field lines.

## References

- Bonanno A, Bozzo G, Camarca M, and Sapia P 2009a. How students interpret a simple situation of induction phenomena, GIREP 2009 Conference – To be published.
- Bonanno A, Bozzo G, Camarca M, Oliva A and Sapia P 2009b. Four physics jar, *Il Nuovo Cimento* **31** 601-15 (2009).
- Bonanno A, Bozzo G, Camarca M, and Sapia P 2010. An on line experiment on electromagnetic induction, in: *Proceedings of the “Multimedia in Physics Teaching and Learning International Conference”, MPTL 14*, Udine (Italy) September 23-35 2009.
- On line at the URL: <http://www.fisica.uniud.it/URDF/mptl14/contents.htm>
- Bonanno A, Bozzo G, Camarca M, and Sapia P 2011. Foucault dissipation in a rolling cylinder: A webcam quantitative study, *European Journal of Physics*, in press (2011).
- Bosio S, Michelini M, Pugliese J S, Sartori C and Stefanel A 2001. A research on conceptual change processes in the context of an informal educational exhibit, in: *Research in Science Education in Europe: the Picture Expands*, Edited by Bandiera M, Caravita S, Torracca E and Vicentini M (Rome, 2001).
- Bosio S, Capocchiani V, Mazzadi M C, Michelini M, Pugliese S, Sartori C, Scillia M L and Stefanel A 1997. Playing, experimenting, thinking: exploring informal learning within an exhibit of simple experiments, in: *New Ways of Teaching Physics*, Edited by Oblac S. et al. (ICPE GIREP Book, Ljubjiana, 1997).
- Bosio S, Capocchiani V, Michelini M, Santi L 1996. Computer on-line to explore thermal properties of matter, in: *Teaching the Science of Condensed Matter and New Materials*, GIREP - ICPE Book, Forum 351 (1996).
- Coletta V P, Phillips A A and Steinert J J 2007. Interpreting force concept inventory scores: Normalized gain and SAT scores. *Phys. Rev. ST Phys. Educ. Res.* **3** – 010106 (2007).
- Galili I and Kaplan D 1997. Changing approach in teaching electromagnetism in a conceptually oriented introductory physics course. *Am. J. Phys.* **65** (7) 657-68
- Heron P L R 2008. Research as a guide for the development and validation of curriculum: Examples in the context of thermal physics. In: *Proceedings of GIREP 2008 International Conference*, to be published.
- Gervasio M, Michelini M and Viola R 2009. Sensors as extension of senses via USB: three case studies on thermal, optical and electrical phenomena. *To be published in the proceedings of Konferencja Laboratoria Fizyczne Wspomagane Komputerowo*, Torun, Poland, 4-6/12/2008.
- Maloney D P, O’Kuma T L, Hieggelke C J and Van Heuvelen A 2001. Surveying students’ conceptual knowledge of electricity and magnetism. *Phys. Educ. Res., Am. J. Phys. Suppl.* **69** (7) S12-23 (2001).
- Meltzer D E and Manivannan K 2002. Transforming the lecture-hall environment: The fully interactive physics lecture. *Am. J. Phys.* **70** 639 (2002).
- Michelini M, Santi L, Stefanel A 2009. On line data acquisition experiments and modeling on electromagnetic induction with coil and magnet. In: the MOSEM<sup>2</sup> Project – Workshop 4 in MPTL14 (University of Udine) *to be published*.
- Michelini M and Viola R 2008. A proposal for a curricular path about electromagnetic induction. In: *Proceedings of GIREP 2008 International Conference*, to be published.
- Michelini M and Viola R 2007. Un laboratorio didattico per future insegnanti di scuola primaria sui nodi di apprendimento dei fenomeni magnetici ed elettromagnetici. *Atti del XLVI Congresso Nazionale A.I.F.- La Fisica nella Scuola, XL, suppl. n. 3*.
- Stefanel A 2008. Disciplinary knots and learning problems in electromagnetism. In: *Frontiers of Fundamental and Computational Physics, 9th International Symposium*, Edited by Sidharth B. G., Honsell F., Sreenivasan K., De Angelis A. (American Institute of Physics, Melville, New York) 231-35.
- Watts D M 1983. Some alternative views of energy, *Phys. Educ.* **18** 213 (1983).
- Thong W M and Gunstone R. 2008. Some Student Conceptions of Electromagnetic Induction, *Res. Sci. Educ.* **38** 31-44 (2008).

### 3.5 – New teaching/learning methods and inquiry based learning

---

## Wave Aspects of Optical Phenomena in the Atmosphere in the Teaching of Physics

Waldemar Berej, Marek Budziński

w.berej@poczta.umcs.lublin.pl, marek.budzinski@umcs.pl

Institute of Physics, Maria Curie-Skłodowska University, Lublin, Poland

Wave aspects of different optical phenomena in the atmosphere are hardly incorporated into physics textbooks. In general, these phenomena are rarely treated and explained in the teaching of physics. At school, one usually acquires only a crude knowledge about the rainbow and nothing else.

A few months ago we asked students from 4 secondary schools (aged 16 or 17) in different cities of the Lublin region to enumerate optical phenomena in the atmosphere other than the rainbow. In 196 responses received, the most frequently mentioned were: aurora borealis – 82%, lighting – 24% and mirages – 14%. Only a few students enumerated the blue colour of sky (6 students) or the Brocken spectre (3 students). Nobody mentioned the phenomenon known as the corona.

The corona is one of the most frequently encountered optical phenomena in the atmosphere but, compared to the rainbow and the halo, it belongs to a rather neglected part of meteorological optics. The semi-popular book [1], well known by sky-watchers, contains only one page about it.

The corona appears as coloured rings surrounding a luminous source, usually the moon or the sun, when it is seen through a mist of thin cloud. The simplest form of the corona consists of a bright aureole, blueish in the centre and brownish on the periphery. When the corona is more fully developed, the aureole is surrounded by one or more (up to four) rings of lesser intensity and delicate colours passing from blueish on the inside to red on the outside. The colours are not pure and considerably mixed with white light. The angular radius of the innermost ring ranges from  $2^\circ$  to  $4^\circ$ . The appearance of this phenomenon clearly suggests that it is caused by the diffraction of light on tiny droplets present in clouds as it is very similar to the diffraction pattern for a circular aperture. The very best coronae are formed in clouds composed of small droplets that are all of almost the same size. The phenomenon described above is often referred to (even by some physicists) as a halo, which is very misleading.

There are several ways to reproduce this phenomenon in the laboratory. We prefer the most classic way dating back to Joseph Fraunhofer and using lycopodium spores. These spores of the club moss lycopodium are rather uniform in shape and size – measured with a microscope, they are about  $30\ \mu\text{m}$  in diameter. It simply suffices to shine the laser through spores thinly dispersed on a glass slide and onto a display screen. It is worth mentioning that this strictly corresponds to so called pollen coronae which in nature are caused by pine and birch pollen. When lycopodium powder is not accessible, one can use randomly distributed circular discs generated by a computer, displayed on a monitor and subsequently photographed [2].

Naturally, one could think of creating the effect of the corona in the lab by producing an artificial cloud of small drops, but such experiment is not easy to perform [3]. Instead of real water drops it is better to use small glass spheres which are often deposited on newly painted white roadway lines. We acquired a few kilograms of these “safety beads” from one manufacturer in Poland.

In the pictures below we show the result of light scattering by a very thin layer of glass beads. Beads used for the first picture had diameters smaller than  $40\ \mu\text{m}$  while for the other one were in the range from  $40\ \mu\text{m}$  to  $60\ \mu\text{m}$ . As the source of almost white light we used a halogen lamp in the optical system of an ordinary slide projector. In the centre of the screen

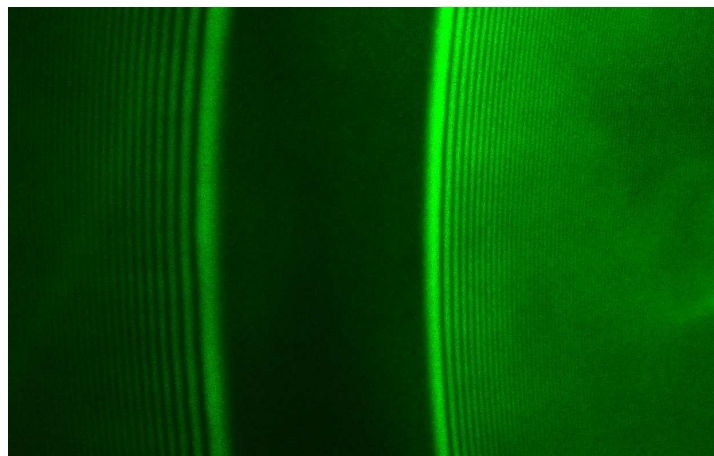


a small black disk was placed to avoid high intensity there when overexposure was applied in order to register further rings.



The idea to use glass beads to reproduce optical phenomena in the atmosphere in the lab is not new. There is for instance, a well known experiment with a “home-made” rainbow [4], [5] in which glass beads are attached to a piece of black card.

The second spectacular experiment reveals a whole series of interference fringes when a water droplet, pending from a needle of a syringe, is illuminated by a laser light source. We used relatively strong 30 mW laser, though any laser pointer is also a good choice. In the picture one can clearly see two series of typical interference fringes separated by a dark band.



As a matter of fact, it is one of the simplest interference experiments to perform. Furthermore, it

gives really very spectacular displays. This experiment deserves a wider attention than it has received so far though it has been reported many times in the literature [6], [7]. It was also a subject (under the title “Brilliant pattern”) of one problem posed to students competing in the 23<sup>rd</sup> International Young Physicists’ Tournament in 2010.

Presumably, for many students it will not be clear how this experiment is connected to the rainbow. Indeed, it is not an easy task to explain the origin of the fringes if students are not familiar with certain more subtle aspects of rainbow formation.

First of all, one could easily measure that the main fringes of each series are observed in the direction of about  $40^\circ$  (a strong and narrow one) and about  $50^\circ$  (a weaker and wider one) with respect to the backward direction. These values correspond to the angles giving the position of primary and secondary rainbows observed in nature. It was proven by Descartes in his remarkable “Discours de l’arc-en-ciel”, which is a masterpiece of scientific investigation, that the rays which suffer the least deviation in the drops result in the greatest intensity of



light scattered. In such a way they contribute to the formation of the primary (one internal reflection) and secondary (two internal reflections) bow.

The next circumstance relevant here is the occurrence of the so called supernumerary bows. These are the additional faint pastel fringes sometimes observed just beneath the primary bow. It is important to recognize that the Cartesian (and Newtonian) theory of the rainbow was unable to account for them.

Even a short history of investigations leading to a better understanding of the rainbow clearly reveals the complex nature of this phenomenon. So it is a good place to review briefly the most important achievements in the theoretical description of scattering of light waves by water droplets covering the period from the very beginning of the 19<sup>th</sup> century, when Thomas Young explained supernumerary bows, till the second half of the 20<sup>th</sup> century, when precise numerical calculations, based on the solution of Maxwell's equations for an electromagnetic plane wave incident upon homogeneous sphere, were performed.

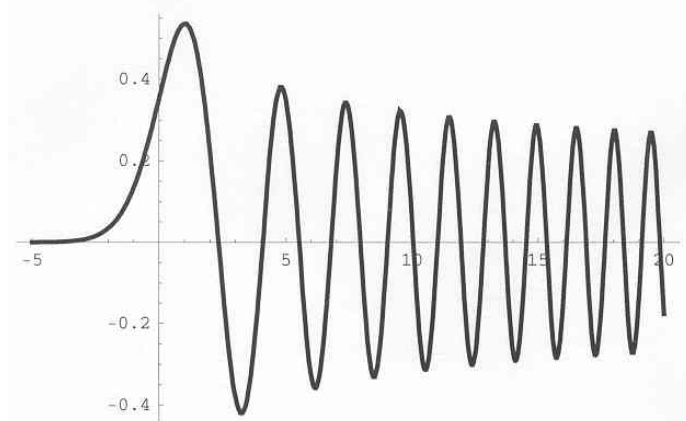
Interestingly enough, in both cases treated here, the crucial theoretical results are the work of one person: an English astronomer and mathematician, George Biddell Airy. Trained in the Cambridge system, he was very good at applied mathematics. In 1834 he investigated the diffraction on a circular aperture [8], and two years later he started to study diffraction by water droplets [9]. In both cases the scalar Huygens-Fresnel diffraction theory was applied and the resulting amplitude of the outgoing light wave was found in the form of integral expressions. Both integrals obtained in the mathematical treatment of these two problems are not expressible in elementary functions. Their numerical values when taken between the appropriate limits were very carefully tabulated by Airy. In the case of the rainbow, calculating the numerical values was extremely difficult and laborious because of very rapid oscillations of the integrand.

The integral for circular aperture defines what was later named the Bessel function of the first order. Due to the axial symmetry of the problem this Bessel function replaces here the sinus function present in the mathematical description of diffraction by a slit. The central spot in the diffraction pattern corresponding to the towering central maximum is known as Airy disk.

Trying to find the intensity of light in the vicinity of Cartesian ray (the ray of minimum deviation), Airy found the approximate form of the wavefront for light inside the water droplet, described by the cubic function having a point of inflection, and then expressed the intensity of scattered light in terms of a "rainbow integral", subsequently renamed the Airy integral in his honor. It is analogous to the Fresnel integrals, which arise in the description of diffraction pattern near the edge. The Airy integral is closely related to the now familiar Airy function which exponentially decays on one side of the zero while oscillates with diminishing amplitude on the other side.

As the wavefront traverses the raindrop, it folds over itself and upon emergence from the drop it becomes cusped. Thus the diffraction pattern for the rainbow may be thought of as arising from interference of its two arms, which produces a series of bright and dark fringes.

The graph of the rainbow integral shows that there is rapidly decreasing illumination in the region for which geometrical optics predicts total shadow. The first maximum has the largest amplitude



and corresponds to the primary bow. It should be stressed that in the Airy approach the direction of maximum intensity is slightly different from that of the Cartesian ray. A set of remaining maxima corresponds to the supernumerary bows.

The paper [9] ends with a 10-page appendix devoted to a detailed description of the method of numerical computation of the definite integral introduced in it. However, Airy was able to find the position of the first maximum only. In the experiments with vertical cylindrical streams of water, Miller in some cases measured the positions of thirty fringes (our second experiment is just the modern version of that performed in the middle of the 19<sup>th</sup> century). Exhaustive comparison of observations and theoretical results was possible when Gabriel Stokes found an ingenious method to put Airy integral in the form from which its numerical value could be calculated with extreme facility.

As soon as the electromagnetic theory of light was proposed by J.C. Maxwell, it became possible to give a precise formulation of the rainbow problem. A solution was found in 1908 by Gustav Mie [10] in the form of a slowly convergent infinite series of partial waves. The number of terms that must be retained in this series to get reliable results is of the same order of magnitude as the so called size parameter which is defined as the ratio of the droplet circumference to the wavelength of light. In practice, size parameters up to several thousand must be taken into account. Mie theory computations became feasible with the development of computers and efficient algorithms. Now they can be done with standard PCs.

One should realize that the explanation of the corona based on what is now called the Fraunhofer case (the far field case) in diffraction theory, is adequate for not too small drops. For drops only several times greater than the wave length (e.g. of radius 10  $\mu\text{m}$ ) the simple diffraction approach gives results which significantly differ [11] from the exact Mie theory. The validity of the Airy approximation is also restricted to the large sizes.

Finally, we would like to mention one widely appreciated handbook of university physics which incorporated both subjects described in this paper: the seventh edition of Halliday and Resnick's "Fundamentals of Physics", written by Jearl Walker. In this book there is a problem to solve with a picture of the corona around the moon as well as a small subsection "Rainbow and the Optical Interference" which contains in the qualitative manner essential elements of wave approach to the rainbow.

- [1] R. Greenler, *Rainbows, Halos and Glories*, Cambridge University Press, Cambridge, 1980
- [2] L. Cowley, P. Laven, M. Vollmer: „Rings around the sun and moon: coronae and diffraction”, *Physics Education*, Vol. 40, (2005), 51-59
- [3] L.W. Brown, “Following Wilson into the clouds”, *Physics Education*, **15** (1980), 380-385
- [4] C.M. Cartwright, “Rainbows”, *Physics Education* **27** (1992), 155-158
- [5] R. Marshall, “Make your own rainbow”, *Physics Education* **38** (2003), 345
- [6] J. Walker, “Multiple rainbows from single drops of water and other liquids,” *American Journal of Physics* **44**, (1976), 421-433
- [7] M. Vollmer, R. Tammer, “Laboratory experiments in atmospheric optics”, *Applied Optics* **37** (1999), 1557-1568
- [8] G.B. Airy, ”On the Diffraction of an Object-glass with Circular Aperture”, *Transactions of Cambridge Philosophical Society* **5** (1835), 283-291
- [9] G.B. Airy, ”On the intensity of light in the neighbourhood of a caustic”, *Transactions of Cambridge Philosophical Society* **6** (1838), 378-402
- [10] G. Mie, „Beiträge zur Optik trüber Medien, speziell kolloidaler Metallösungen”, *Annalen der Physik* **25** (1908), 377
- [11] P. Laven, ”Optics of a water drop”, [www.philiplaven.com](http://www.philiplaven.com)

# **Exploring the sources of magnetic field and the interactions between them to interpret electromagnetic induction: a proposal of conceptual laboratory**

Michelini Marisa, Vercellati Stefano

michelini@fisica.uniud.it, vercellati@fisica.uniud.it

Research Unit in Physics Education of the University of Udine

## **Introduction**

Today, electromagnetic phenomena are part of everyday life, even as concern pupils' toys. Scientific terms as "magnetic poles" and "magnetic field", become part of the ordinary language. However, this popularization of physical terms has been obtained through a loss of accuracy of the real physics meaning of these quantities. In science education, the problem of the correlation between everyday and scientific knowledge is one of the main problems in learning (Pfundt & Duit, 1993). In the framework of the Model of Educational Reconstruction (Duit et al, 2005), it is therefore necessary, to design inquired based learning paths (McDermott, 2004) in which students are personally involved in minds and hands-on experimental activities. With the aim to investigate how pupils develop interpretative abilities to explain situations and artefacts from the results of several phenomenological investigations of physics quantities, a specific activity was designed in the framework of the Cognitive Laboratory of Operative Exploration (CLOE). CLOE labs are experimental laboratories carried out by a researcher on a specific topic, based on a semi-structured interview protocol that represents an open work plan built through the proposal of everyday life scenarios in which everyday situations are studied following narrative reasoning by means of simple hands-on apparatus (Michelini, 2005).

## **Research questions**

In this work, three research questions were investigated: RQ1) how do an operative exploration help students to identify and organize electromagnetic phenomena; RQ2) how is the exploration and the comparison between phenomena useful to help students in the interpretation of artefacts; RQ3) how are exploratory elements reused by students in the interpretation of artefacts.

## **Context and Sample**

The experimental activity was carried out in an informal context during a science festival – Mediaexpo 2009 – involving 135 middle school students aged from eleven to fourteen years old (6<sup>th</sup> to 8<sup>th</sup> school grade). Seven classes were involved: one of 6<sup>th</sup> grade (20 students), three of 7<sup>th</sup> grade (60 students) and three of 8<sup>th</sup> grade (55 students).

The activity was divided into two phases: 1) an inquired based explorative phase; 2) a structured analysis of an artefact.

During the inquired based learning path, pupils worked in groups of 5 members each, but every student had his/her own personal worksheet. Communication between groups was not interdicted and after each experimental exploration of a specific phenomenon there was a class discussion in which students organize their observations and learn how to draw conclusions, share and defend their ideas and challenge them with opposing perspectives or argumentations.

The equipment used by each group during this phases is composed by: 6 compasses, 1 A4 cardboard, a pair of big magnetic plates (with a surface of 10x20 cm) with their holder, an analogical micro-ammeter, many coils with different surfaces and number of circumvolutions and a couple of conducting wires to do the connection between the coils and the micro-ammeter. In the setting setup this activity, particularly attention was devoted to the setup of the classroom: garden



Figure 1: Induction torch

table in plastic were used to avoid interference with the functioning of the compasses and several everyday objects (Hifi, computer, mobile phone...) and some laboratory object (coils, coils carrying a current, generator...) were placed around the classroom. During the structured analysis of the artefact, the analysis of a particular tool (an induction torch – Figure 1) was proposed to students. Before, being allowed only to look at it, students had to describe the artefact on a structured personal worksheet. Then they can improve their description being permitted to touch and experiment its functioning. Indeed a final class

discussion was promoted.

## Instruments and methods

The inquired base explorative phase consist of four learning macro-steps: S1) study of the compasses behavior (far away from other objects); S2) study of the compasses behavior near a magnet; S3) individuation of the magnetic field source; S4) discovery and study of the electromagnetic induction.

During the macro-steps S1, we proposed to students a simple first exploration of the Earth magnetic field using a compass as an explorer of a propriety of the space. Students during this step used compasses and cardboard. Here students had to answer on their personal worksheets to three specific questions:

S1.Q1 After had placed the cardboard on the table with a compass upon it (Figure 2). Which is the direction of the compass needle?

S1.Q2 Rotate the cardboard at an arbitrary angle; wait and observe the needle. Which is the direction of the needle now?

S1.Q3 If we use more than one compass, which will be the direction of their needle? Try it.



Figure 2: Compass

After this first group of questions, as for each one of the all other steps, there was a class discussion concerning the observed phenomena.

During S2, students began to explore the behavior of a set of compasses when they are placed near a magnet.

S2.Q1 Paste 6 compasses on the perimeter of a sheet of paper (4 on the corners and 2 on the middle of the longest side – Figure 3). Then put a magnet between them. Which are the orientations of the needles?

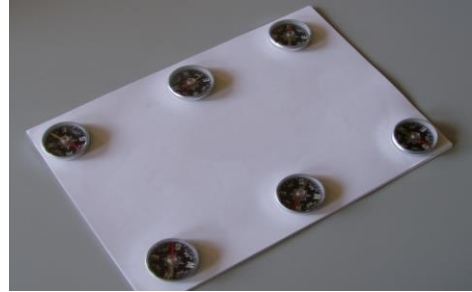


Figure 3: Set of compasses paste on cardboard

In S3 students were free to explore all the objects present in the classroom with the set of compasses built in S2. In particular, they looked for other types of objects that are sources of magnetic field. In this phase, the setup of the classroom is pivotal: students must be able to find a large set (as large as possible) of common everyday-life objects.

S3.Q1 Are magnets the only objects able to change the orientation of the needles? There are other objects able to do it? Explore the room and check each object using the table of compasses. Which object(s) can do it? (Which not?).

S3.Q2 Which are the common element(s) of the objects that can orientate the needles?

S3.Q3 Put a coil between compasses. How are the direction of the needle?

S3.Q4 Leave the coils between the compasses and connect it to the generator. What is happening to the compass needles?

In S4, after that students had shown that an electric current generates a magnetic field, they explore the phenomenon of the electromagnetic induction through problem solving like approach. For this phase, data were not collected on the worksheets because an experimentation of this phase was already done and described in a previous work (Michelini & Vercellati, 2009).

At the end of the inquired learning based path, during the second phase, the artefact was offered to students without any introductive explanation. The only instructions gave to students were concerning the methodology that they had to follow in the artefact analysis. Initially, only looking at it, students had to say what is it, describe it and, after that, when all group had finished the first part, they can touch the artefact experimenting its functioning and, if they think it is necessary, they can improve their first description.

## Data

To S1.Q1: 68% answered NORD, 20% reported the cardinal point that appear to be under the needle tip (as shown in the Figure 2, in the used compasses the cardinal point are painted on a fix background), 7% direction described it by referring to objects present into the classroom and 5% did not answer.

Concerning S1.Q2: 80% highlighted that the direction is always the same, 10% said that the direction change, 5% say that the cardinal point change and 5% did not answer.

At S1Q3: 96% said that all compass needles have the same direction and 4% did not answer.

During the first class discussion, the shared opinion was that with this experiment we show that there is a propriety in the space, which oriented the compass needles.

S2.Q1: describing what is happening to the needle of the compasses pasted on the cardboard, students said that: all needles point toward the magnet (39%), the needles of the compasses placed into the corner point to the magnet, but the other two are parallel to the magnet (24%), compasses become crazy (20%), needles change their direction (6%), compasses lose their magnetization (5%), did not answer (7%).

Replying at the question “Which are the object(s) that can change the orientation of the needles?” (S3.Q1) students answered reporting a series of tables that are summarized in Table 1 and graphically represented in Figure 4.

Tested object	Can (%)	Cannot (%)	That's strange (%)
Coils with current	32,6		
Coils	26,7	24,4	
HiFi	21,5	12,6	
Computer	20,7	15,6	
Mobile Phone	17,0	3,0	
Fire Extinguisher	15,6	34,1	8,1
Blackboard	11,9	14,1	
TV	7,4		
Windows	5,2	14,1	
Generator	3,7		
Metal pipe	1,5		
Plastic table	0,7	8,1	
Professors' head	0,7	0,7	
Blackboard eraser	0,7		

Table 1: Which object can change the orientation of the needle?

In S3.Q2 students highlighted as common element into the objects able to change the direction of the compass needles, the presence of an electric current (61%), while 39% did not answer.

This last conclusion, done by a majority of the students, become a general class conclusion with the exploration proposed with S3.Q3 and S3.Q4.

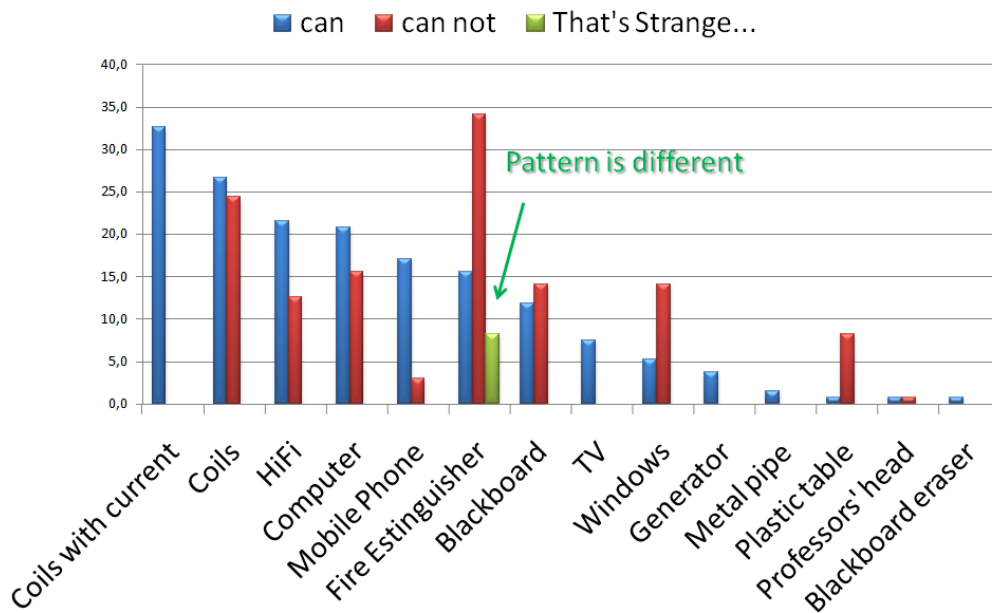


Figure 4: Which are the object(s) that can change the orientation of the compass needles?

During S3 discussion, the discussion about the fire extinguisher as an object that have or not an own magnetic field was a point of particular interest (please note that during the activity, the ‘magnetic field’ was introduced by the researcher only as label for the discovered that can reoriented the compass needles). In particular students highlight that, when they go near the fire extinguisher with the table of compasses, all of them point to the object, but there are not needle that lies parallel to it, so they argue that it has not got an own magnetic field.

As said before, during the S4 phase was not collected written data. There was only a discussion in which students highlighted the main characteristic of the electromagnetic induction (as for instance its transient nature) and explicated the different ways in which is possible to realize it.

Concerning the analysis of the artefact, 56% of the students said that it is an electric torch, another 38% of the students said specifying that it is an electric torch with a coil that produces energy and 6% did not reply.

### Data analysis

Looking at the question S1.Q1; S1.Q2 and S1.Q3 is manifest how the experimental approach promotes an evolution of the ways in which students face the analysis of the phenomena. In S1.Q1, in fact, 68% of the student gave as answer as assertion without looking at the experimental apparatus (i.e. “compass needle point to North”) respect to a 27% of them that referred their answers to the specific situation. Already in S1.Q2 students focused their

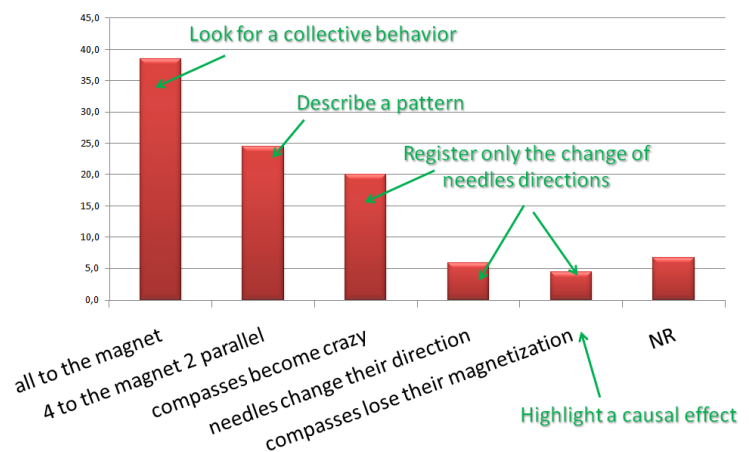


Figure 5: S2Q1 Analysis

answers on what they think as important elements in the description of the phenomena: compass needle 80%, compass background and needle 15%. In S1.Q3 96% of the students refer their answers only to the direction of the needle.

Analysing questions S2.Q1 four different students' approaches are manifest (Figure 5): 39% of the students looked for a collective behaviour of the needles, 24% recognized the presence of a pattern, while the remaining 31% of the students who answered to this question reported only a change in the needle directions. In particular, 5% of the students highlight a casual effect.

As concern for question S3.Q1, the more interesting part was the students discussion in which each everyday object was analysed and in particular, relating to the case of the fire extinguisher, students propose a method aimed at discerning if an object that is able to change the needle orientation have or not an own magnetic field.

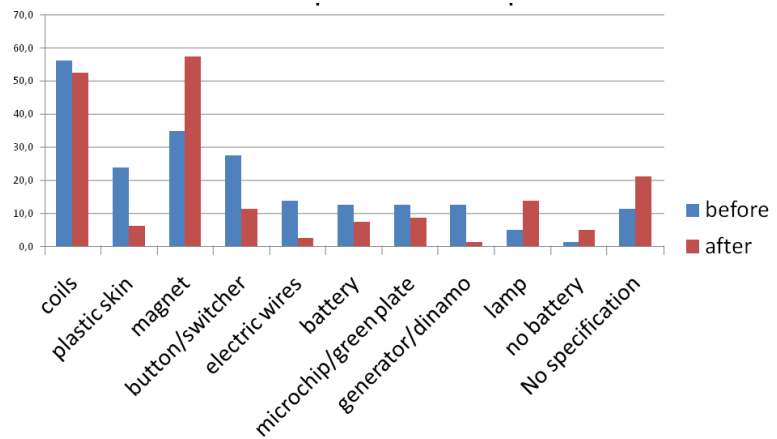


Figure 6: Elements used in artefact description before and after they touch it

Instead, during exploration of the artefact it is interesting to examine how students' descriptions evolve from before to after that they can touch and analyze the artefact in an experimental way. In particular, in Figure 6 are displayed which are the elements that they used to describe the artefact. Is interesting how the pure structural elements (as for instance the plastic skin) almost disappear after the experimental phase making way for new emerging functional elements (as magnet and lamp).

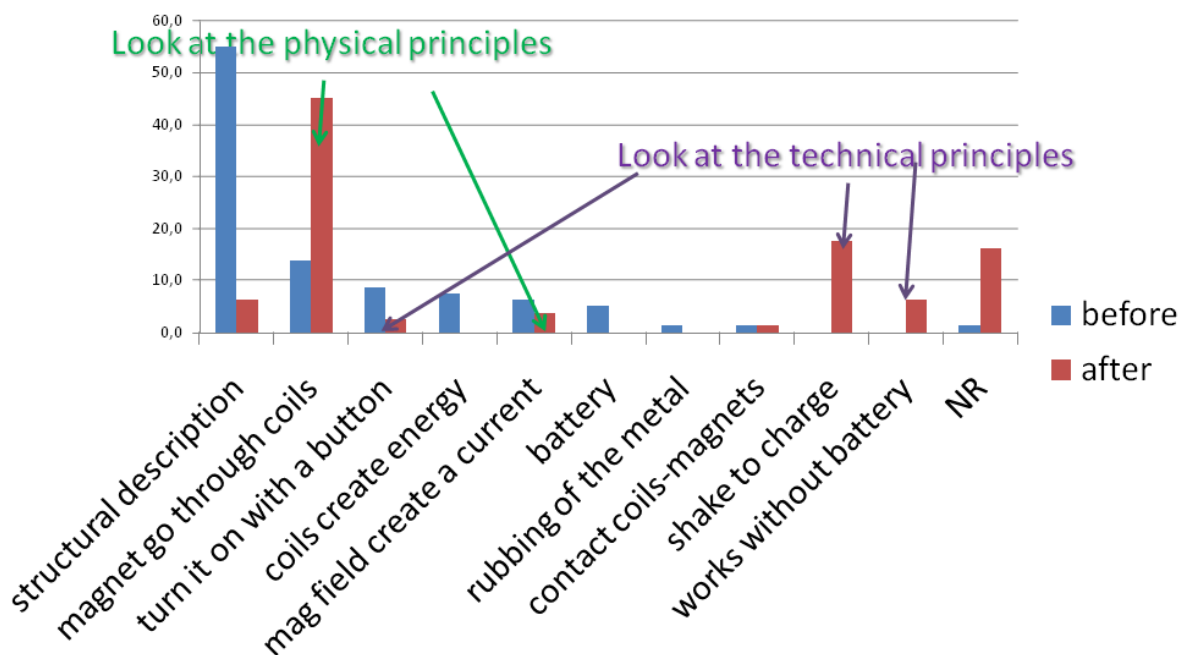


Figure 7: How does the artefact work?



This trend was even more explicit when we look at the changes in the students' explanations of the functioning of the induction torch (Figure 7). Structural description fall down from 55% to 6% and two principal different approaches emerge in the artefact analysis: one looking at the physical principles (49%), the other looking at the technical principles (26%).

## **Conclusions**

From this experimentation tree main important results emerge: 1) an operative approach helps students to focus on relevant elements for the processes to switch from a structural to a functional description; 2) comparison and analogies between artefact elements and explored elements allow students to re-use their previous discoveries into the interpretation of the artefact; 3) Experimental exploration allows and promote the switching between a structural to a functional description of the artefact highlighting so which are the scientific and the technical principle on which the artefact works.

## **References**

- Duit R., Gropengießer H., & Kattmann U. (2005). Towards science education research that is relevant for improving practice: The model of educational reconstruction. In H.E. Fischer, Ed., *Developing standards in research on science education* (pp. 1-9). London: Taylor & Francis.
- McDermott LC, *Physics education research: The key to student learning and teacher preparation*, Proceedings of the 2nd International GIREP Seminar on Quality Development in Teacher Education and Training, 30-34 (2004).
- Michelini M, *The Learning Challenge: A Bridge between Everyday Experience and Scientific Knowledge*, GIREP book of selected contributions, Ljubljana, 2005.
- Michelini M, Vercellati S, *Primary pupils explore the relationship between magnetic field and electricity*, GIREP vol. 2, 2009.
- Pfundt D, Duit R, *Students' Alternative Frameworks and Science Education*, IPN Kiel, Germany 1993.

# **Secondary School Students' Use and Transformation of Arguments from an Energy Dilemma Text**

Marina Castells, Aikaterini Konstantinidou & Sandra Gilabert

## **ABSTRACT**

Argumentation has recently become a common topic of research in science education. Studies on argumentation have involved students carrying out various types of tasks (writing a text, a group discussion, completing a questionnaire, a whole class discussion, among others). However, few researchers have studied the influence of a given text's characteristics on students' performance of a task and on their argumentation.

This study examined how the arguments in a written text on an energy dilemma influenced students' individual pieces of writing on this subject. The sample was two groups of students from two secondary schools in Barcelona.

The arguments given by students and the complex structures of their argumentative texts were influenced by the content and structure of the arguments in the energy dilemma text.

## **KEYWORDS**

Argumentation, secondary education, discourse analysis, critical thinking education

## **BACKGROUND, PURPOSE AND FRAMEWORK**

Argumentation has recently become a common topic of research in science education (Castells et al., 2007; Erduran & Jiménez-Aleixandre, 2008; Buty & Plantin, 2008). This research field includes the study of discursive practices that occur in the construction of science (and in science learning), the articulation and justification of scientific statements, and the arguments and counter-arguments that can be given in theoretical or practical scientific (Latour, 1987; Latour & Mayer, 1986) or scholarly contexts (Duschl, 1999; Jiménez-Aleixandre et al., 2000; Erduran et al., 2004; Simon et al., 2006; Castells et al., 2007). Studies on argumentation have involved students carrying out several types of tasks (writing a text, a group discussion, completing a questionnaire, a whole class discussion, among others). However, few researchers have investigated how the characteristics of a text given to students influence the performance of an argumentation task.

Research in science education has emphasized pedagogical strategies that foster arguments and discussions (Driver et al., 2000; Simon et al., 2006; Kelly, 1986; Khun, 1991). This is in line with research on Critical Thinking<sup>1</sup> (Ennis, 1987), which considers argumentation an essential skill to develop (Ennis, 1992; Felton, 2004; Felton, 2008). In a broad sense, our work will also contribute to this field.

---

<sup>1</sup> Critical thinking is a concept developed some years ago in the context of a democratic society in relation to discussions about the skills that a citizen needs to participate in social and political life in a reflective and critical way (Ennis, 1987).

The *aim* of this study is to investigate how the argumentative characteristics of an energy dilemma text influence students' individually written pieces.

Our *framework* is based on several studies on argumentation and the general concept of an argument consisting of a thesis and one or several reasons that are used to defend the thesis or conclusion.

The *sample* was two groups of 13-14 year old students from two secondary schools in Barcelona. Each group was made up of around fifty students.

## **RATIONALE**

Our hypothesis is that the quality of students' argumentative texts would improve if students had sufficient knowledge or information to construct the arguments.

### **Methodology**

*Task.* A dilemma involving two sources of energy was presented to students in a written text. The students' task consisted of writing a piece to explain and justify their position on this dilemma, on the basis of the information and arguments are provided in the verbal text. Students had to perform the task individually.

The dilemma given to students was not a very simple text. Its construction was based on how dilemmas used to be presented to students. It included two possible options and two main arguments (we use the term "reasons" in the written text) in favour of each of the options (construction of a nuclear power station and construction of a fossil-fuel power station). Each main argument included several partial arguments (smaller reasons), which could be presented as positive reasons for supporting one of the options or reasons for rejecting the other option. In summary, the text included claims, justifications, limitations and contra-limitations in a structured complex way.

Students performed the task individually in one session of their regular mathematics class (50 minutes), in the presence of the maths teacher and two researchers. The dilemma was given to students on a sheet of paper and they had to write on another sheet. Consequently, they had a lot of space for writing and many of them produced very long texts.

### **Analytical framework**

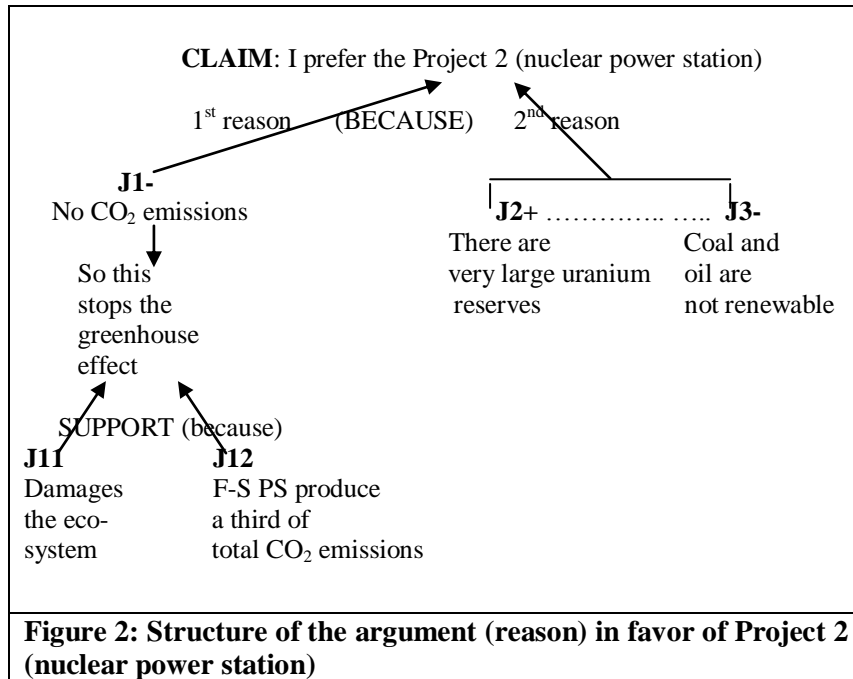
We adapted theoretical concepts used in other research and identified the main elements of students' arguments. In particular, we identified claims, justifications, limitations, contra-limitations, and contra-claims. According to our adapted framework:

*Claims* are the option or thesis that is supported.

*Justifications* or reasons, which can be positive or negative, are the information given by the student to support their claims or reject the other option. They can include relevant information from the dilemma text or from the media, as well as ideas, opinions, values or personal experiences that support the chosen option.

*Limitation* is an argument or reason that considers and includes negative or missing aspects of the main argument that a student gives in favour of the chosen option. A limitation can also recognize positive or convincing aspects of the arguments given by other people in favour of the rejected option. In general, in an argumentative text, a justification can be about the claim, another justification, a limitation, etc.





## ANALYSIS AND RESULTS

### The claims

**Table 1. Summary of claims made by students (first breakdown)**

Claim	Fossil-fuel PS (including forced choice)	Nuclear PS (including forced choice)	Other option	Not possible to choose	No answer
School 1 (50)	36 (18)	46 (23)	8 (4)	8 (4)	2 (1)
School 2 (58)	39.7 (23)	55.2 (32)	3.4 (2)	1.7 (1)	0 (0)
Total (108)	38 (41)	50.9 (55)	5.6 (6)	4.6 (5)	0.9 (1)

In the first part of the task, approximately half of the students (51%) chose the nuclear power station and fewer students (38%) chose the fossil-fuel power station. Many students stated that they would prefer another renewable type of station. However, as we asked them to choose between two options, they did this even though they did not like either of them very much. Quite a considerable percentage of students chose an alternative source of energy or said that it was not possible to choose (10%).

If we want to highlight the students who did not like the options given in the dilemma, we can break down the categories in another way, by combining ‘Other option’, ‘Fossil-fuel power station, forced choice’ and ‘Nuclear power station, forced choice’, as these three mean ‘students who did not like the claims in the dilemma’.

**Table 2. Summary of claims chosen by students (2<sup>nd</sup> breakdown)**

School \ Claim	Fossil-fuel station	Nuclear station	Other option and fossil-fuel or nuclear, forced choice	Not possible to choose	No answer
School 1 (50)	26 (13)	40 (20)	24 (12)	8 (4)	2 (1)
School 2 (58)	31 (18)	51.7 (30)	15.5 (9)	1.7 (1)	0 (0)
Total (108)	28.7 (31)	46.3 (50)	19.4 (21)	4.6 (5)	0.9 (1)

Table 2 indicates that nearly 20% of students did not like the two options given in the dilemma. Despite this percentage, near half of the students (46.3%) chose the nuclear power station, i.e. more students chose the nuclear power station than the fossil-fuel power station.

### The arguments

We consider that the concept of argument consists of a thesis or *claim* and *reasons* given to defend or reject this thesis (claim). Each reason can be independent, have other reasons supporting it or some limitations. The reasons can also be called justifications if the thesis is known previously, as in this research.

#### *Number of arguments*

Students gave one or more reasons in their written texts. We count these reasons as arguments. More than 40% of the total sample gave more than three arguments or reasons to justify their chosen claim, and nearly 40% gave three arguments. Our hypothesis is that there are many partial arguments (reasons) in the dilemma, which students are able to use in their texts or take as inspiration to construct their own arguments. In fact, it seems that the information they read in the dilemma helped provide them with reasons to use.

**Table 3. Summary of the number of arguments (reasons) given by students**

School \ N° Arg	1 arg.	2 arg.	3 arg.	More than 3 arg.
School 1 (49)	10.2 (5)	18.4 (9)	24.5 (12)	46.9 (23)
School 2 (58)	5.2 (3)	8.6 (5)	51.7 (30)	34.5 (20)
Total (107)	7.5 (8)	13.1 (14)	39.3 (42)	40.2 (43)

1 student did not answer and did not provide any arguments

It is interesting to note *that when students did not agree with either of the options given in the dilemma, they gave more than three arguments.*

Students that chose the claim F-F PS + F-F PS but.... tended to give three arguments, whilst students who chose NPS + NPS but.... gave more than three arguments.

**Table 4: Comparison of the number of arguments according to the type of claim**  
(Breakdown of F-F PS + F-F PS but.... And NPS + NPS but)

N° Arg.	1 arg.	2 arg.	3 arg.	More than 3 arg.
F-F PS + F-F PS but (41)	4.9 (2)	19.5 (8)	43.9 (18)	31.7 (13)
NPS + NPS but....(55)	7.3 (4)	9.1 (5)	40.0 (22)	43.6 (24)
Other options (6)	33.3 (2)	0 (0)	33.3 (2)	33.3 (2)
Impossible (5)	0 (0)	20.0 (1)	0 (0)	80.0 (4)
Total (107)	7.5 (8)	13.1 (14)	39.3 (42)	40.2 (43)

+ 1 no answer

### Types of arguments (reasons) by content

Most students' used mainly the reasons given in the dilemma in their arguments. However, some students introduced new reasons that were not included in the dilemma. We categorized the students' arguments into 7 types according to content. These categories are presented below. Each one is illustrated with some examples from the students' texts for the first part of the task.

**Table 5. Types of partial arguments or reasons given by the students, by content**

Type of partial argument or reason	Criteria	Examples of arguments given by students
Accidents	Students mention accidents, or talk about hazards in general without specifying much about these risks.	3T. Neither of the two projects is suitable. Really, there is not very much information to decide between the two. .... In favour of Project 1 <i>is the argument that there is no risk of nuclear accidents.</i> Against Project 2 <i>we can say that nuclear accidents can occur, as can radiation leaks....</i>
Radiation leaks/hazards of radioactive substances	Students refer specifically to radiation leaks or risks due to the treatment of radioactive substances.	34T. Project 1. Nuclear power stations <i>are dangerous because of radioactive leaks.....</i>
CO <sub>2</sub> and climate change	Students relate CO <sub>2</sub> emissions with climate change	22G. I support Project 2. .... <i>Perhaps it has not really been proved that CO<sub>2</sub> emissions are the cause of climate change, but I think there is more likelihood of a fossil-fuel station affecting global warming than that of an accident nuclear occurring.</i>
Cyclic CO <sub>2</sub>	Students refer in a positive or negative way to the idea that CO <sub>2</sub> emission is a cyclic process that does not cause climate change.	69T. Project 1. <i>If it is true that climate change and the greenhouse effect function in a cyclic way, then even if a power station emits a lot of CO<sub>2</sub>, it will not be the cause of all these problems, such as the extinction of animals and the melting of the ice caps. These problems will occur because of a combination of many things, that is, cars, industries, planes, etc</i>
Fossil resources	Students talk of fossil resources (coal, crude oil) that are not renewable.	27T. Project 2, because coal and oil are running out. <i>In 40 years there will be no more coal and if we change to combustion of fossil fuels, they will run out quickly.</i>

More uranium	The uranium used in the nuclear power station is abundant in nature or more abundant than fossil fuels	2T. I don't like either of the projects, I would choose Project 3, renewable energy, such as self-sufficient buildings, energy from solar panels, wind parks and energy from biomass or other alternative energies, but if I was forced to choose, I would chose Project 2. .... <i>There is more uranium than coal.</i>
Contamination	They talk of contamination that sometimes means CO <sub>2</sub> and some other substances from the power station or radioactive substances leaking from the power station...	7T. Project 1. <i>Because a nuclear power station contaminates more than a fossil-fuel power station. ...</i>
No need for more sources of energy.	They consider that there are enough power stations and so there is no need to build new ones.	104T. <i>I think that there are enough energy and power stations of different types of energy such as wind, hydraulic and electrical energy, etc. in Spain, so there is no reason to build one in Barcelona.</i>
Efficiency	Students state that nuclear stations or fossil-fuel stations are more efficient.	25T. Project 2. .... <i>Nuclear power stations produce more energy (greater efficiency).</i>
Nuclear waste problem	They present the problem of nuclear waste, generally considering it to be negative.	32T. Project 1, but I like other options, such as a wind park or solar panels. .... <i>Radioactive waste is also a problem for the environment.</i>
More safety in nuclear stations (new technologies, more modern technologies, et.c)	Students accept nuclear power stations because the technology will continue to advance and this will help prevent accidents or leaks.	27T: Project 2: ... <i>A nuclear power station has a high risk level because there could be radioactive leaks, but if we take care of the stations and highly qualified professionals work there, I think the risk will drop. ....</i>
Other		19G Neither of the Projects. We can put solar panels in houses. .... <i>The thermal power station consumes resources and there is not much fossil fuel left, but silica is very abundant in nature. In addition, there is a lot of space for solar panels in Barcelona and Barcelona is a very sunny town.</i>

On the basis of these categories, we compiled a table of the types of partial arguments or reasons given by students in the first part of the task (% of the number total of reasons in each group).

**Table 6. Types of partial argument or reasons given by students, by content**  
(% of the total number of reasons by school)

Types Arg School	Accid.	Esc.	CO <sub>2</sub> Climate Chang	Cyclic CO <sub>2</sub>	Fossil Resour	More Urani. um	Con-tami.	Other source	More Energ	Nu-clear resid	More Secur	Othe Reas
School 1 (169)	13.0 (22)	6.5 (11)	14.8 (25)	5.3 (9)	11.8 (20)	9.5 (16)	12.4 (21)	3.0 (5)	3.0 (5)	3.0 (5)	3.6 (6)	14.2 (24)
School 2 (197)	10.7 (21)	10.2 (20)	17.8 (35)	6.1 (12)	11.7 (23)	9.1 (18)	7.6 (15)	3.6 (7)	3.6 (7)	1.5 (3)	7.6 (15)	10.7 (21)
Total (366)	11.7 (43)	8.5 (31)	16.1 (59)	5.7 (21)	11.7 (43)	9.3 (34)	9.8 (36)	3.3 (12)	3.3 (12)	2.2 (8)	5.7 (21)	12.3 (45)

In general, students mainly argued using the reasons given in the energy dilemma text, but some introduced new reasons of their own.



There was wide variation in the types of arguments or reasons students gave in their written texts, but there were no significant differences between the two schools in the sample. The most common argument or reason given by the students was ‘CO<sub>2</sub> is considered a cause of climate change’, followed by ‘other types of reasons not given in the dilemma’. Students presented arguments or reasons of their own, such as ‘we live in a sunny country where solar panels can be used’ and ‘The problem of nuclear waste’. We believe that some reasons were taken from media sources, particularly as some months before the students carried out the task there had been a very strong debate in Catalonia about where to build a store for nuclear waste. The argument or reason of ‘the hazard of nuclear accidents’ was given by a high percentage of students, as was the ‘fossil resource’ argument. These comprised nearly 12% of the total reasons given by the students.

It is also interesting is to analyse the types of arguments in relation to the claim chosen by the students (Table 7). The table below was compiled by combining ‘Fossil-fuel power station with fossil-fuel power station, forced choice’ and ‘Nuclear power station with nuclear power station, forced choice’.

**Table 7. Types of partial arguments or reasons by content, out of the total number of reasons by type of claim**

Breakdown (fossil-fuel PS + fossil-fuel PS, forced choice and nuclear PS + nuclear PS, forced choice)

Type Arg Claim	Accid	Esc	CO <sub>2</sub> Clim Chan	CO <sub>2</sub> Cycli	Fossil Resid	More Uran	Con tami	Othe Sour Ces	More Ener	Nucle resid	More Secur	Oth
Fossil-fuel + forced choice 133	21.1 (28)	12.8 (17)	7.5 (10)	12.0 (16)	8.3 (11)	1.5 (2)	9.8 (13)	7.5 (10)	1.5 (2)	3.0 (4)	2.3 (3)	2.8 (17)
Nuclear + forced choice 192	5.2 (10)	6.3 (12)	23.4 (45)	1.6 (3)	13.5 (26)	15.1 (29)	8.9 (17)	0 (0)	4.7 (9)	1.6 (3)	8.9 (17)	10.9 (21)
Other (18)	5.6 (1)	5.6 (1)	11.1 (2)	5.6 (1)	11.1 (2)	5.6 (1)	16.7 (3)	5.6 (1)	5.6 (1)	0 (0)	5.6 (1)	22.2 (4)
Not possi. to choose (23)	17.4 (4)	4.3 (1)	13.0 (3)	4.3 (1)	17.4 (4)	8.7 (2)	13.0 (3)	4.3 (1)	0.0 (0)	4.3 (1)	0 (0)	13.0 (3)
Total (366)	11.7 (43)	8.5 (31)	16.4 (60)	5.7 (21)	11.7 (43)	9.3 (34)	9.8 (36)	3.3 (12)	3.3 (12)	2.2 (8)	5.7 (21)	12.3 (45)

Table 7 shows that the reasons with the highest percentages varied according to the chosen claim. In addition, this Table indicates that the types of reasons seem dependent on the chosen claim. When students chose the claim ‘Fossil-fuel power station or forced choice’, the highest percentage of reasons corresponded to ‘nuclear accidents’ (21.1%), followed by ‘radioactive leaks’ (12.8%) and ‘other reasons not in the dilemma’ (12.8%). When students chose the claim ‘Nuclear power station’ or ‘Nuclear station, forced choice’, the highest percentage of reasons corresponded to ‘CO<sub>2</sub> climate change’ (23.4%) and ‘there is more uranium’ (15%). When students chose ‘other options’ to those presented in the dilemma, the highest percentage of reasons corresponded to ‘other reasons not given in the dilemma’ (22.2%) and ‘contamination’ (16.7%). Finally, when students chose the claim ‘not possible to chose’, the largest percentage of reasons corresponded to ‘accidents’ and ‘fossil resources’ (17.4% in each case).

A second breakdown (Other + Fossil-fuel power station, forced choice + Nuclear power station, forced choice) joins the categories that correspond to students who do not like the two main options in the dilemma (the corresponding Table is not presented here).

This new breakdown shows that when students selected the option ‘Other’ or ‘Fossil-fuel and nuclear, forced choice’, the highest percentage of reasons corresponded to ‘CO<sub>2</sub> climate Change’ and ‘Contamination’ (13.2% in each case) and when students chose the claim ‘Not possible to chose’, the highest percentage of reasons corresponded to ‘Accidents’ and ‘Fossil resources’ (17.4% in each case).

### Types of justifications in comparison with the justifications in the dilemma

Reason in the dilemma for Project 1 (Fossil-fuel power station):

#### 1<sup>st</sup> reason

1. Project 1 solves the problem of energy for Barcelona.
2. There is no risk of nuclear accidents with radioactive leaks, because
3. no radioactive substances are handled in a F-F PS.
4. Many countries are replacing their nuclear PS.

#### 2<sup>nd</sup> reason

But 1. The F-F PS releases a lot of CO<sub>2</sub> into the atmosphere.

But 2. It is not certain that the CO<sub>2</sub> causes climate change,

Because

3. Changes of temperature over time seem a cyclic process.

Reasons in the dilemma for Project 2 (Nuclear power station)

#### 1<sup>st</sup> reason

1. The NPS does not emit CO<sub>2</sub> and therefore it does not affect climate change.

Because 2. Climate change will harm the ecosystems of living beings.

2. The F-F PS produces 1/3 of the CO<sub>2</sub> that reaches the atmosphere.

#### 2<sup>nd</sup> reason

1. The uranium reserves are very high.

Instead 2. Coal and oil are not renewable substances.

We defined the following categories for the analysis:

Types of justifications in comparison with the justifications in the dilemma	Criteria	Examples of students' arguments
<b>G. Like the justifications in the dilemma</b>	This category includes students who gave the same reasons as in the dilemma. The students' reasons are only part of the main reasons in the dilemma.	<b>14G:</b> <i>I would choose Project 1. J1: as Project 2 seems extremely hazardous for the environment and for us. J2: I also think exactly like them (the Company) about the issue of CO<sub>2</sub> (it is cyclic and does not cause climate change). J2: 2nd part of the 2nd reason in favour of Project 1 (reason 2) in the dilemma.</i>
<b>H. Like the justifications in the dilemma, but adapts or mixes parts from more than one justification.</b>	This includes ideas that are in the reasons of the dilemma, but the students only use them partially and change the form of expression	<b>29T:</b> <i>Project 1: J1. The fossil-fuel power station, although it contaminates, J2: is not dangerous. J3: I am against the nuclear power station because at any time an accident can happen like that at Chernobyl. J1 and J2 take the ideas of the second part of the 1<sup>st</sup> reason in favour of Project 1. J3 gathers the last part of the 1<sup>st</sup></i>

	and/or combine one part of a reason with parts of other reasons.	reason in favour of Project 1, with the specification of the Chernobyl accident.
<b>I. Like a justification in the dilemma, but with an added opinion or evaluation.</b>	This category was created as some students add an evaluation or opinion to the reasons given in the dilemma.	<b>107T.</b> <i>Project 2. I think that the reasons they give (in the dilemma) are quite correct. J1: First, we know that coal and crude oil are materials that will run out in a short period of time, but there is a lot of uranium. J2: I think that although the experts say that the emissions of CO<sub>2</sub> do not affect climate change, they affect many other things; they make the consequences of climate change worse and they harm our life and the life of other living beings.</i> J1: This student gathered information from the 2 <sup>nd</sup> reason in favour of Project 2, and added an evaluation. J2: He gathered what is said in the second part of the 2 <sup>nd</sup> reason in favour of Project 1, but judged the experts' opinions that climate change can be produced by other factors. He indicated that he does not believe this and considered that CO <sub>2</sub> emissions could affect other things.
<b>J. Justification included in the dilemma, but it was reinterpreted or its meaning changed.</b>	Student gathered the information given in a justification/reason for the dilemma, but he/she misinterpreted it and used this information with a different meaning.	<b>101T.</b> <i>Project 2. J1: I opt for the future, because nuclear power stations do not emit CO<sub>2</sub> into the atmosphere. Furthermore, J2: nuclear stations use uranium that is a source of renewable energy.</i> J2: The student adapted the 2 <sup>nd</sup> reason for Project 2, when he mistakenly stated that uranium is renewable.
<b>K. New justification that is not included in the dilemma and is not a personal opinion.</b>	This category includes new justifications that were not included in the dilemma.	<b>29T:</b> <i>Project 1: ..... J4: At the fossil-fuel power station, we can install filters to reduce contamination and stop sulphur from being released, this will prevent rain acid. J5: Nuclear waste is not recyclable.</i> J4: a new justification that is not in the dilemma: we can intervene to improve the fossil-fuel power station. J5: a new justification that is not in the dilemma: the problem of nuclear waste, with relevant data provided.
<b>L. New justification that is a personal opinion and not based on relevant information.</b>	This category includes new justifications with opinions or personal evaluations that do not refer to something relevant from the perspective of a science or social problem.	<b>66T.</b> <i>I chose Project 1 and also alternative sources of energy. .... J3: I would prefer a fossil-fuel power station because between me and some plants, I prefer to live and the plants die.</i> <i>Alternative claim. J4: If the fossil-fuel station won, the Council and the Catalan Government would have to carry out a campaign so that people reduced CO<sub>2</sub> emissions, by, for example, not using cars as often, making better use of public transport, etc. In addition, the Council could introduce new technologies, such as the use of electric buses.</i> J3. New justification of personal opinion: I prefer to live rather than plants and the environment. J4. New justification that could be a proposal: CO <sub>2</sub> would have to be reduced in several ways, by regulations, etc.
<b>M. New justification that is a personal opinion based on relevant information.</b>	New justification with a personal opinion, but with reference to some relevant information that is not necessarily certain or validated data; it only has to be meaningful to the students.	<b>77T.</b> <i>Project 1. ....J3. If the fossil fuel and crude oil reserves run out, what would be good would be to use renewable sources of energy, such as solar energy, hydraulic and wind power that do not cause any damage. Perhaps the best idea would be to use many sources of non-contaminant energy at the same time.</i> J3. A new justification that was not in the dilemma: if the fossil fuel resources run out, we could use renewable energies.

**Table 8. Comparison of students' justifications and justifications in the dilemma, by school**

Types of jus. N° Just	Like jus. in the dilemma.	Like jus. in the dilemma. but adapted or combined	Like jus. in the dilem. with opinions or evaluat.	Jus. in the dilemma reinter. or change of meaning	New jus. that is not in the dilemma	New jus. that is a personal opinion, not based on relevant information	New jus. that is a personal opinion based on relevant information
School 1 (162)	46.9 (76)	12.3 (20)	9.9 (16)	1.9 (3)	22.2 (36)	2.5 (4)	4.3 (7)
School 2 (215)	28.8 (62)	12.1 (26)	17.2 (37)	3.7 (8)	26 (56)	0 (0)	12.1 (26)
Total (377)	36.6 (138)	12.2 (46)	14.1 (53)	2.9 (11)	24.4 (92)	1.1 (4)	8.9 (33)

From these tables, we can conclude that many students used the arguments given in the dilemma in their own way, by changing the order, mixing reasons for Project 1 with those for Project 2, cutting the arguments and using some parts only, and adding evaluations or reinterpreting them with different or opposite meanings. There are some differences between schools: students from School 1 gave more justifications like those in the dilemma than students in School 2.

**Table 9. Comparison of students' justifications with justifications from the dilemma, by type of claim**

Types of just. Claim	Like jus. in the dilem.	Like jus. in the dilem., but adapted or mixed	Like jus. in the dilem., with opinion or evaluat.	Jus. of the dilemma reinter. or changed meaning	New jus. that is not in the dilem.	New jus. that is personal opinion, not based on relevant information	New jus. that is personal opinion based on relevant information
Fossil-fuel (150)	27.3 (41)	14.7 (22)	22.7 (34)	2.7 (4)	20.7 (31)	0 (0)	12 (18)
Nuclear (192)	40.1 (77)	9.9 (19)	9.9 (19)	3.6 (7)	27.6 (53)	1.6 (3)	7.3 (14)
Other (14)	35.7 (5)	21.4 (3)	0 (0)	0 (0)	42.9 (6)	0 (0)	0 (0)
No choice (21)	71.4 (15)	9.5 (2)	0 (0)	0 (0)	9.5 (2)	4.8 (1)	4.8 (1)
Total jus. (377)	36.6 (138)	12.2 (46)	14.1 (53)	2.9 (11)	24.4 (92)	1.1 (4)	8.8 (33)

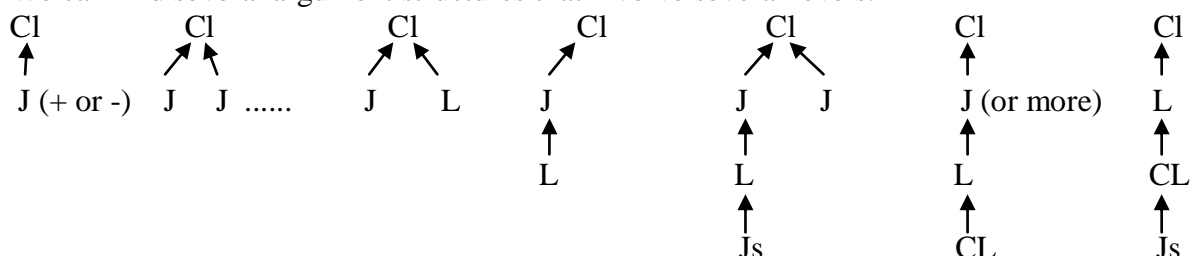
### Qualitative analysis of the argumentative structure of students' texts

According to our analytical framework, we identified claims, justifications, limitations, contra-limitations and contra-claims in the students' written texts, where possible, and we constructed the tree structure of these elements.

Examples of the above categories:

Claim	I defend Project 2: installation of a nuclear power station proposed by the ENE company.
Justification of the fossil-fuel power station	<i>Because this cannot affect people as nuclear energy would do. J1 In addition, I think it is better because there will not be any radioactive leaks. J2</i>
Justification of the fossil-fuel power station	<i>The main reason, as explained in the texts, is that coal and the rest of the fossil fuels cannot be renewed in a short period of time, and so, after a certain time, the thermal PS would not be useful and it would have been a waste of money.</i>
Limitation	<i>Though it is true that a nuclear PS can be more dangerous and could involve risks of nuclear accidents</i>
Contra-limitation	<i>But it is also true that risks have to be taken to gain rewards</i>
Contra-claim	<i>I wouldn't vote for either of them because I don't think they are good options. .... I would have proposed the solution of putting solar panels on the roof of every house...</i>

We can find several argument structures that involve several levels:



These combinations can become more complex, without or with repetition of the elements considered. Below, we present some of the answers and the complex structures that we identified in the students' texts.

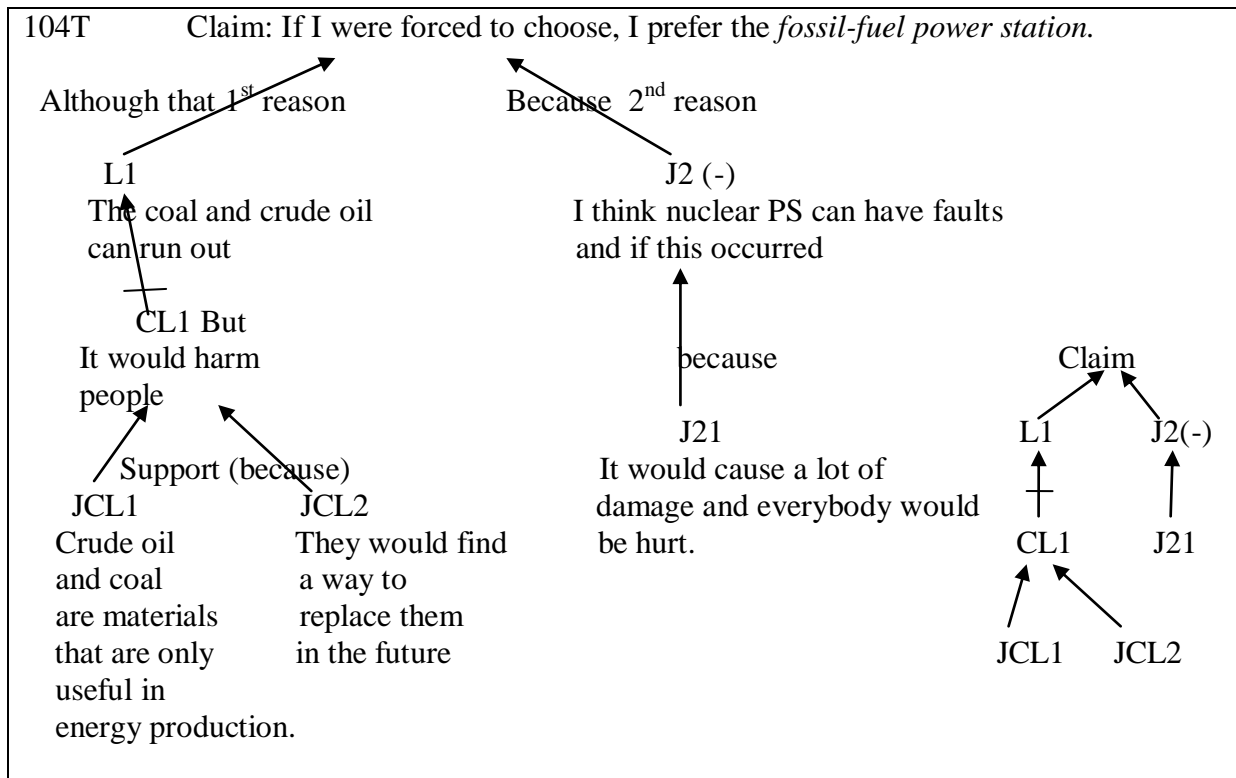
**104T** I think that there is enough energy and power stations of different types of energy, such as wind hydraulic and electrical energy, in Spain. Therefore, there is no need to build a new power station in Barcelona, and especially not in the middle of the city. In principle, I wouldn't support either of the options because the two contaminate and damage the environment. But if I were forced to choose, I prefer the fossil-fuel power station.

Arguments:

1st. I would choose this (fossil-fuel) because I think that crude oil and coal are materials that do not have any other uses except energy production (or the manufacture of some products). Therefore, it would not hurt anyone if these resources were used up. If this occurred, they would find a way to replace these materials in the future.

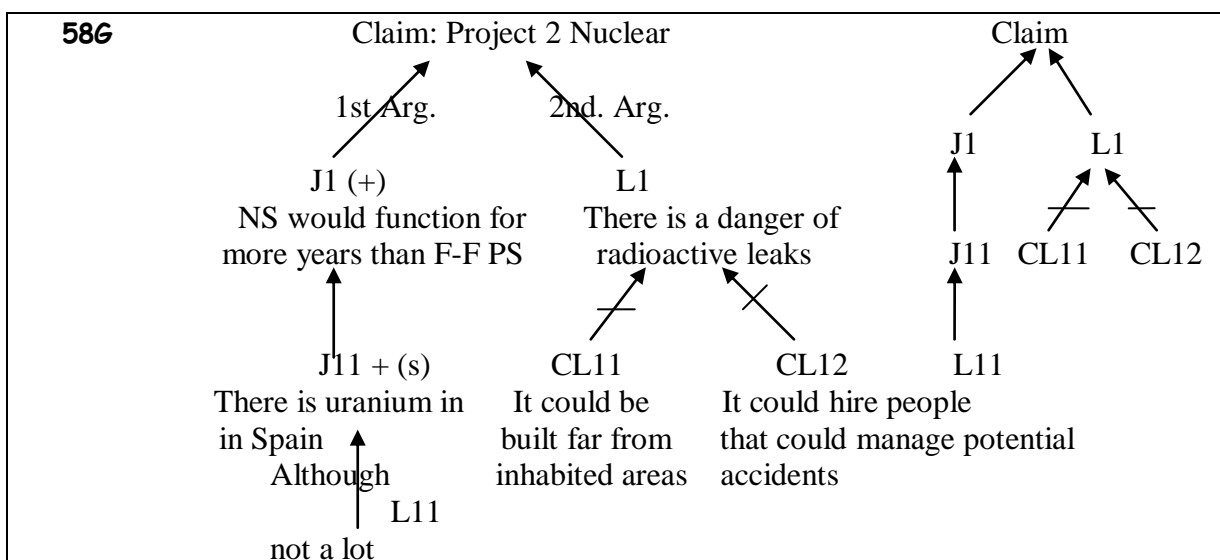
2nd. I have always been against nuclear power stations because I think that if a fault arises, a lot of damage can be caused and everyone will be hurt.

Condition: If one of these power stations had to be built, I would ask the Catalan Government to build it as far as possible from people to prevent catastrophes.



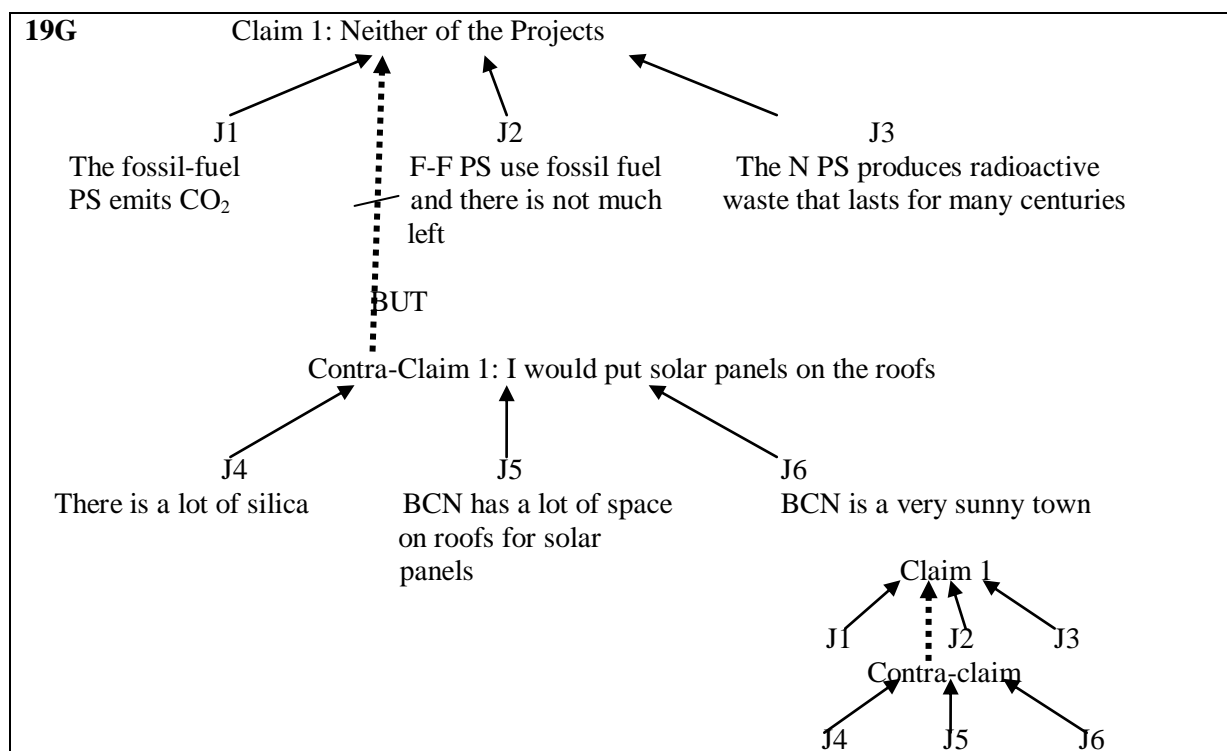
**58G.** Project 2. Nuclear power station. I would choose the second Project because although there is not a lot of uranium in Spain, there is some and this would enable a nuclear power station to operate for longer than a fossil-fuel power station, which would have to shut when the fossil fuels run out.

It is true that there is a high risk of some leaks, but it could be built far from inhabited areas and people could be hired who had learnt all the possible cases to manage all potential accidents.



**19G** Neither of the Projects because I do not think either of them is any good; the fossil-fuel power station produces CO<sub>2</sub> and consumes fossil fuel resources, which are limited, and the

nuclear power station would produce too much radioactive waste, which lasts for a long time. I would propose the solution of putting solar panels on the roof of every house. Silica is present in soil, so it is very abundant in nature and solar panels would not emit CO<sub>2</sub> or radioactive waste. In addition, there is a lot of space for solar panels in Barcelona; this would not be a problem as all the buildings in Barcelona have roofs where solar panels could be placed. Barcelona is a very sunny town.



These few examples show the argument structure of the students' texts. We can see that the energy dilemma text influenced students' arguments, in terms of the content of their partial arguments, and the structure of their argumentative texts.

A quantitative study of the argumentative quality of the students' texts is still underway, but from the qualitative analysis we have carried out we can state that many students showed high quality argumentation, as they constructed highly complex argumentative texts that included justifications at several levels, two types of limitations (recognizing the limitations of a self-claim or the advantages of another refuted claim), contra-limitations, and, in some cases, a contra-claim, as in the example 19G. The most interesting aspect for us is that students had not received specific instruction about argumentation prior to the task. In this particular case, we consider that knowledge of the context also helped students to construct their arguments. Other students produced simpler argumentative structures, based on justifications and not on limitations and contra-limitations. However, a considerable number of students presented quite good quality argumentation in their texts.

## CONCLUSIONS AND COMMENTS

Our results do not agree with the results of other research that state that the argumentative skills of students are of low level. However, most students did not demonstrate critical thinking. We found that many students accepted the information we gave them in the dilemma without criticism. We can also state that some students were influenced by the

media. Therefore, a higher percentage of students accepted the construction of a nuclear power station, when the Catalan media had defended this type of power station at the time that the task was undertaken. Students do not use premises of scientific knowledge in their arguments. Therefore, another conclusion of this study is the need to improve scientific learning. The identification of premises and argumentative structures in the students' texts helps us to understand the way students think by themselves and to see the influence of their reading. It provides argumentative resources for the teacher to use to help students improve their scientific knowledge and their attitudes towards socioscientific problems.

## REFERENCES

- Buty, Ch. & Plantin, Ch. (2008) *Argumenter en classe de sciences. Du débat à l'apprentissage*. Institute National de Recherche Pédagogique.
- Castells, M., Enciso, J., Cerveró, J.M., Lopez, P., Cabellos, M. (2007) What can we Learn from a Study of Argumentation in the Students Answers and Group Discussion to Open Physics' problems? In: Pintó & Couso (Eds) *Contribution for Science Education Research*. Dordrecht: Springer, pp 427-431
- Castells, M., Erduran, S., Konstantinidou, A. (2008). GIREP Conference 2008, Comparison between Catalan and English students' argumentation discussing about scientific or socioscientific issues. Nicosia, Cyprus
- Driver, R., Newton, P. & Osborne, J. (2000). Establishing the norms of scientific argumentation in classrooms. *Science Education*, 84, 287-312.
- Driver, R., Guesne, E. & Tiberghien, A. (1985). *Children's ideas in science*, Milton Keynes: Open University Press
- Duschl, R. (2007) Quality Argumentation and Epistemic Criteria. At: Erduran & Jiménez-Aleixandre (Eds) *Argumentation in Science Education*, Netherlands: Springer, 159-175
- Duschl R. & Osborne, J. (2002). Supporting and Promoting Argumentation Discourse in Science Education, *Studies in Science Education*. 38, 39-72.
- Duschl, R. (2007) Quality Argumentation and Epistemic Criteria. Erduran, S. & Jiménez-Aleixandre, M.P. (eds) (2007) *Argumentation in Science Education*. Netherlands: Springer, 155-171
- Ennis, R. H.: 1987, 'A Taxonomy of Critical Thinking Dispositions and Abilities', in J. Baron & R. Sternberg (eds.), *Teaching Thinking Skills: Theory and Practice*, Freeman, New York.
- Erduran, S., Simon S. & Osborne, J. (2004). TAPping into Argumentations: Developments in the Application of Toulmin's Argument Pattern for Studying Sciences Discourse. *Science Education*, 88, (6), 915-933.
- Erduran, S., & Jimenez-Aleixandre, M. P. (Eds.) (2008). *Argumentation in Science Education: Perspectives from Classroom-Based Research*. Dordrecht: Springer
- Felton, M. (2008) Deliverative argument: Using classroom discourse to foster critical thinking. *Temps d'Educació*, Núm 33
- Jiménez-Aleixandre, M.P, Burgalló, & Duschl R.A. (2000) "Doing the lesson": or "doing science": Argument in high school genetics. *Science Education* 84 (6) 1-36
- Kelly, G. J., Druker, S., & Chen, C. (1998). Students' reasoning about electricity: Combining performance assessments with argumentation analysis. *International Journal of Science Education*, 20 (7), 849-871.
- Konstantinidou, A. & Castells, M. (2008) Argumentation as a Means for Understanding Science: Past and Present. *Proceedings of 3er International Conference of the European Society for the History of Science*. Vienna
- Osborne, J., Erduran, S., & Simon, S. (2004). Enhancing the quality of argumentation in school science. *Journal of Research in Science Teaching*, 41(10), 994-1020.
- Sadler, T. D. (2004). Informal reasoning regarding socioscientific issues: a critical review of research. *Journal of Research in Science Teaching*, 41(5), 513-536.



Simon, S., Erduran, S. & Osborne, J. (2006). Learning to teach argumentation: Research and development in the science classroom. *International Journal of Science Education*, 27(14), pp.137-162.

Walton, D.; Reed C.; Magnano, F. *Argumentation Schemes* (2008) Cambridge University Press

### **ACKNOWLEDGEMENTS**

The research was supported by the Spanish Ministry of Science and Innovation (Project EDU2010-21995-C02-02, 2009-2011) and coordinated by Maria Mercè Garcia Milà from the University of Barcelona.

### **AFFILIATION AND ADDRESS**

Marina Castells  
Aikaterini Konstaninidou  
Department of Science and Mathematics Education  
University of Barcelona  
P. O. Passeig de la Vall d'Hebron, 171  
(08014) Barcelona  
Catalonia (Spain)

Sandra Gilabert  
Department of Psychology of Education  
University of Barcelona

Email: [marina.castells@ub.edu](mailto:marina.castells@ub.edu)

# PROGRESSIONS OF STUDENTS' MENTAL MODELS OF MAGNETISM ACROSS SCALE

David Sederberg<sup>[1,5]</sup>, Anna-Leena Latvala<sup>[2,7]</sup>, Anssi Lindell<sup>[3,6]</sup>, Lynn Bryan<sup>[1,4,8]</sup> & Jouni Viiri<sup>[2,9]</sup>

<sup>[1]</sup>Department of Curriculum and Instruction, Purdue University, USA

<sup>[2]</sup>Department of Teacher Education, University of Jyväskylä, Finland

<sup>[3]</sup>Department of Physics, University of Jyväskylä, Finland

<sup>[4]</sup>Department of Physics, Purdue University, USA

E-mail: <sup>[5]</sup>dsederbe@purdue.edu, <sup>[6]</sup>anssi.lindell@edu.jyu.fi, <sup>[7]</sup>anna-leena.m.latvala@jyu.fi,

<sup>[8]</sup>lbryan@purdue.edu, <sup>[9]</sup>jouni.viiri@edu.jyu.fi

## ABSTRACT

We describe progressions of mental models of secondary students for a “case” physical science topic – magnetism. Secondary students in Finland (N=19) and in the United States (N=67) engaged in a series of six lessons designed to target aspects of magnetism known to challenge learners (e.g., the confusion of magnetism with charge), the structure and organization of matter (e.g., alignment and magnetic domains), and magnetic fields. Our study included analysis of students applying their mental models of magnetism to the size dependent behavior of magnetic materials at the nanoscale. Our findings indicate that, despite identifiable “turning points” in students’ revisions of their mental models, tenuous non-normative beliefs still persisted even in the face of repeated trials and conflicting evidence.

## 1 INTRODUCTION

Magnetism is a phenomenon that fascinates and interests students of all ages and has been a long standing staple of science curricula in grades K-12 and beyond. Yet, conceptions of magnetic phenomena have not been investigated as extensively and intensively as other physical phenomena such as force, electricity, and heat (Guisasola, Almudi & Zubimendi, 2004; Hickey & Schibeci, 1999; Ravanis, Panagiotis, & Vitoratos, 2010). To date, however, there are few studies that have examined the ways in which students’ conceptions of magnetism are related to one another, or how students revise their mental models in the light of contradictory evidence and reflection during the learning process.

In this study, we investigated trajectories by which upper secondary students in Finland and the U.S. constructed, critiqued and revised their mental models of magnetism across three key concepts– structure and alignment (magnetic domains), the distinction between magnetism and static charge, and the reciprocal nature in magnetic interactions (magnetic fields)– as well the effects of scale.

## 2 THEORETICAL FRAMEWORK

### 2.1 STUDENTS’ IDEAS OF MAGNETISM.

Researchers have catalogued a range of students’ ideas about magnetism such as (a) models of magnetism (Borges & Gilbert, 1998; Constantinou, Raftopoulos, & Spanoudis, 2001; Erikson, 1994); (b) the confusion between magnetism and static charge (Borges & Gilbert, 1998; Hickey & Schibeci, 1999; Maloney, 1985); (c) action at a distance (Bar, Zinn, & Rubin, 1997); and (d) the concept of field (Bradamante & Viennot, 2007; Guisasola, et al., 2004; Guth & Pegg, 1994). Concepts of magnetism pose a challenge for learners, as they require higher levels of cognition and mental imagery than more concrete and tangible concepts. The idea of a force being exerted on another without touching, for example, or an object being attracted equally to either pole of a magnet are counterintuitive for children

(Constantinou, et al., 2001). Children commonly view electrostatic and magnetic interactions as the same phenomenon. The beliefs that the poles of a magnet are oppositely charged, or that magnetizing involves the transfer or rearrangement of charge, have been revealed from studies of learners across multiple ages and educational levels (Borges & Gilbert, 1998; Maloney, 1985; Saglam & Millar, 2006). Likewise, upper secondary and even university students often believe that the magnetic field has a finite boundary (Bar, et al., 1997), or that the field lines are a concrete entity (Guisasola, et al., 2004; Guth & Pegg, 1994). Understanding concepts such as these requires the ability to construct mental models of abstract concepts, including spatial orientation, noncontact forces and the nature and organization of matter.

## **2.2 MENTAL MODELS.**

Learning science is to construct, revise and justify self-constructed mental models, not simply to adapt models imposed by others and taken for granted (Lehrer, 2009). Mental models provide the learner a means to organize and make sense of concepts in meaningful ways to help understand the world (Harrison & Treagust, 1996), and as a representation of something in the absence of the real thing (Greca & Moriera, 1997), mental models require the learner to reduce a phenomenon to those elements most meaningful to create a personally meaningful representation (Gilbert & Boulter, 1995).

The goal of this research was to investigate the progression and coherence of students' mental models in learning about magnetism, to answer the questions: (1) What is the initial nature of secondary students' mental models of magnetism and magnetic phenomena? (2) How does the content of students' models change during instruction? and (3) What aspects among students' mental models provide coherent explanatory power across scale?

## **4 DESIGN**

This study was guided by an interpretive research orientation. We used a quasi-experimental design to compare the construction and progression of mental models of selected concepts of magnetism.

### **4.1 PARTICIPANTS**

The participants in this study consisted of two samples: (1) a 9<sup>th</sup> grade chemistry class in a small university town in Finland (N = 19; 9 male, 10 female), and (2) a 10<sup>th</sup>-11<sup>th</sup> grade physics class in a U.S. mid-western suburban university town (N=65; 38 male, 27 female).. Neither sample had formally studied magnetism in school prior to this study. The samples were non-random, solicited from secondary schools with which researchers had previously collaborated.

### **4.2 INSTRUCTION**

The magnetism unit consisted of six lessons that were focused on a limited number of concepts, layered to enable students to construct knowledge about magnetism: structure and organization of matter (magnetic domains), magnetic fields, and magnetic interactions. Our goal was not to evaluate the effectiveness of the instruction, but rather to document the status and growth of students' mental models and explanations of magnetic phenomena in the context of a classroom learning experience.

### **4.3 DATA COLLECTION**

Data consists of responses to pre- and post-test items, activity journal pages, embedded assessments, and informal interviews. The post-test was identical to the pre-test

and was administered the day after after instruction ended. The assessment items were paper-and-pencil, open-ended response and drawing.

#### 4.4 DATA ANALYSIS

We used a constant comparative method to generate and revise codes to characterize and fit salient features of students' inscriptions into categories, based on the depth of understanding exhibited and the characteristics portrayed. Audio recorded interviews were used for the triangulation of data, as well as to provide a deeper insight into students' cognition, not accessible from written data alone. Interview audio recordings from the sample in Finland were transcribed in Finnish and then translated into English.

#### 5 ANALYSIS AND FINDINGS

Four characteristics were used to track the progression of students' mental models: (1) elements of static charge, (2) North and South poles, (3) magnetic field, and (4) representations of magnetic domains (Table 1). Two trends were the result of instruction. While one of the six lessons pertained specifically to comparing static charge and magnetic interactions, the U.S. teacher, because of constraints of time, elected not to do this lesson. Additionally, the Finnish teacher employed the use of a textbook representation of domains in guiding students through the negation of their mental models, while in the U.S. classes, students generated their own models. We also note that Finnish students did not refer to poles by North and South in their initial mental models; they referred to magnets by halves of different colors (red and white).

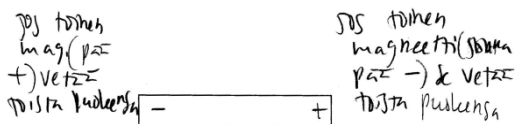
Table 1. Magnet characteristics by percent of sample

Characteristic	Finnish		U.S.	
	Pre	Post	Pre	Post
Static charge	63%	5%	59%	51%
N / S poles	0%	53%	40%	57%
Field	0%	5%	46%	62%
Domains	5%	74%	0%	7%

In the next section, we present two students' progressions of mental models, one from Finland, the other from the U.S. We then examine students' application of their mental models to scale-related magnetic phenomena.

##### 5.1 ANJA (FINLAND): STATIC CHARGE MODEL TO DOMAIN MODEL

Prior to instruction, Anja based her characterization of magnets on charge. In her diagram of a magnet she identified poles with signs of charge and wrote captions to explain what would happen if another magnet was brought near: "If another magnet ( pole is +), it attracts the other;" and "If another magnet (whose pole is -), it attracts the other."

What a magnet is	How a magnet works	Magnet characteristics
"There are different kinds...but always with a positive and a negative end; + and - poles are different...and there are different strengths in magnets."	"It attracts objects to itself; different poles attract different signs to itself or accordingly repel."	 <p>Handwritten Finnish notes: "jos toinen mag (pää +) vetää" and "jos toinen magneetti (toinen pää -) ei vetää". Below the notes is a diagram of a magnet bar with a box containing a minus sign (-) on the left and a plus sign (+) on the right.</p>

Anja also used her charge model to explain how she believed a magnet is attracted to either end of a nail,



erimerukset navat vetze  
toisistaan puoleensa

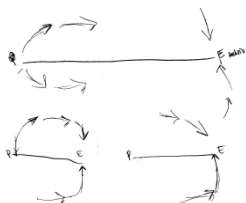
“Opposite poles are attracted to each other.”



hykivät toisistaan  
koska samanmerkkiset navat

“They repel each other because the poles are of the same sign.”

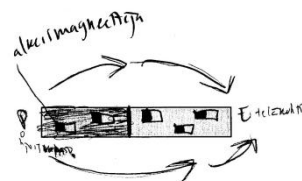
A turning point in the revision of Anja’s thinking was the revision of her mental model to accommodate how a magnetized wire could be cut into pieces, each piece being a whole magnet. Anja began thinking about internal units of which a magnet might be composed, observing that each piece of wire has both a north and south pole and that they behave as magnets, one pole attracted to the other.



“We cut this wire in half and it made separate... magnets, and they are all alike so that there are no differences. The north pole directed to the south, just like in that other one.”

Anja’s post-unit responses indicated a more scientifically normative model, identifying north and south poles, an accurate orientation of field and magnetic domains in her drawing and accompanying explanation.

“A magnet contains domains that cause a magnetic field outside the object. If the domains are not aligned, the object no longer has a magnetic field.”

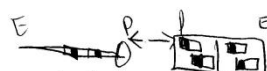


When Anja applied her emerging mental model to the magnet-nail interaction on the post-unit assessment, she viewed the nail as remaining magnetized. Contrary to evidence from the investigations which she conducted, she believed that the nail is attracted to the magnet in one orientation and repelled by the magnet in the other.



erimerukset navat vetze  
alkuimagneetti toisistaan puoleensa

“Different sign domains attract each other.”



samaa merkkiset navat hykivät toisistaan

“Same sign poles repel each other.”

Anja’s mental model progressed toward a more scientific view. Yet while she adopted a mental model based on domains, she seemed to have acquired the common belief that attraction and repulsion are relative to orientation of either the magnet or the object involved in the interaction; attracted at one end, repelled at the other.

## 5.2 CHRISTEN (U.S.): STATIC CHARGE MODEL TO MIXED MODEL

Christen’s mental model of magnetism, prior to, throughout and even after the lessons continued to relate to elements of static charge. She initially defined a magnet as “Something that is usually made of metal and is charged, and is attracted or repelled to something,” and affirmed with a drawing that one end (+) of the magnet attracts while the other (−) repels. She was also not unique in her beliefs that an iron bar can be magnetized by rubbing it with wool

and that a balloon rubbed in her hair would act like a magnet. Christen’s pre-unit model of a magnet and a nail also referred to charge-based interactions.



After she investigated the behavior of a magnetized a paper clip, Christen’s mental model included aspects of a more normative scientific view of magnetism, with specific reference to alignment and domains. Yet she maintained her commitment to the influence of charge in the interaction.

“...the paper clip had the characteristics of a magnet where the domains are aligned and when you drop it, the domains are re-aligned making it not a magnet.”

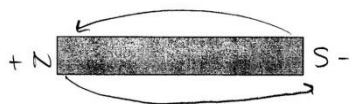


Christen’s mental model of magnetism changed little, mixing non-normative and scientifically normative concepts, contrasted by her post-unit drawings representing the interaction between a nail and a magnet and final magnet description. In the former, she replaced signs of charge with North and South poles and indicated that the nail would be attracted to the magnet in either orientation.



She did not include any indication of domains or field in her drawing, however, so it remains unclear how she believed the nail could be attracted in either orientation.

Christen’s post-unit drawing and description of a magnet indicated that she adhered to the notion of charge in her mental model.

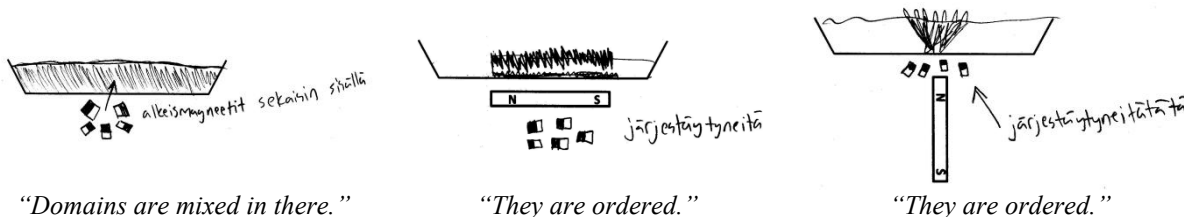


“A magnet is something with two oppositely charged ends that either attract or repel something.”

While she used a North-South notation of magnetic poles and an (inaccurate) indication of a magnetic field in her model, Christen still maintained her commitment to charged poles.

### 5.3 APPLICATION OF STUDENTS’ MENTAL MODELS ACROSS SCALE

The concepts of domains, alignment, field and thermal energy are essential to understanding the behavior of a magnetic fluid (ferrofluid). Students who incorporated the concepts of domains into their mental models were able to offer an account for the behavior of the ferrofluid, based on the mobility of the individual domains. Mikko, for example, contrasts the arrangement of domains, relative to the placement of the magnet.



The domain concept was the lynchpin component of students’ mental models that allowed them to explain this behavior in a manner coherent with the behavior of magnets and magnetic materials.

When asked to explain which would be less likely to remain magnetized, a nanoscale particle or a larger piece, students were more likely to think in terms of the total number of atoms or domains in the piece, than to consider the effects of thermal energy and the relative number of surface to interior atoms. For example, Anja reasoned for the larger piece “*It has more domains than the others.*” Ben referred to the smaller piece losing its magnetism citing, “*Fewer of the atoms in the smaller one would need to move out of their alignment to disrupt the magnetic field, so the smaller one.*” Galeb indirectly referred to thermal energy, “*The smaller cluster because there are more magnetic orientations that could be disrupted around the outside of the cluster vs. the inside.*” Students who maintained charge in their mental models attempted to account for the effects of size relative to charge, “*Because there is less space inside for the charges,*” and “*It’s so small they can’t hold a charge.*”

## 6 CONCLUSIONS

We observed several trends in students’ emerging mental models of magnetism. One such concept is the persistent belief, despite investigations and evidence to the contrary, that one side of a magnet attracts an object, the other side repels. Likewise, students continued to include components of static charge, even incorporating charge into more sophisticated concepts such as magnetic fields and domains.

We also found that, despite investigating the characteristics of magnetic fields, and then using the presence of a field as the identifying characteristic of a magnetized object, students were not likely to incorporate the effect of the field in their mental models of magnetic interactions between magnets and other objects.

There were two “turning points” which were significant in students’ revisions of their mental models. As cited above, Anja’s concept of the domain as an internal unit or magnetic “entity” emerged from her magnetizing and cutting a wire. Likewise, Galeb’s understanding of domains and their role in the process of magnetization emerged from an activity modeling domains as iron filings confined to a drinking straw, “*In the fresh unmagnetized [straw] magnet the domains are not aligned in the same direction and after being magnetized the domains all align in the same direction.*”

Our research contributes important theoretical information about the nature of students’ developing mental models of magnetism. This study serves as a starting point in an ongoing research program that aims to develop cognitively grounded and research-based physical science curricula organized around a limited number of key principles. Additionally, we hope that it can inform the development of physical science curricula that fosters the development of coherent understanding across size and scale.

## REFERENCES:

- Bar, V., Zinn, B., & Rubin, E. (1997). Children’s ideas about action a distance. *International Journal of Science Education, 19*, 1137–1157.
- Borges, A. T., & Gilbert, J. K. (1998). Models of magnetism. *International Journal of Science Education, 20*, 361-378.
- Bradamante, F., & Viennot, L. (2007). Mapping gravitational and magnetic fields with children 9-11: Relevance, difficulties and prospects, *International Journal of Science Education, 29*, 349-372.
- Constantinou, C., Raftopoulos, A., & Spanoudis, G. (2001). Young children’s construction of operational definitions in magnetism: The role of cognitive readiness and scaffolding the learning environment. In J. Moore & K. Stenning (Eds.), *Proceedings of the Twenty-third Annual Conference of the Cognitive Science Society*. London: Routledge.
- Erikson, G. (1994). Pupils’ understanding of magnetism in a practical assessment context: the relationship between content, process and progression. In P. Fensham, R. Gunstone & R. White (Eds.), *The content of science: a constructivist approach to its teaching and learning* (pp. 80-97). London: Falmer Press.
- Gilbert, J. K., & Boulter, C. (1995, April). *Stretching models too far*. Paper presented at the annual meeting of the National Association for Research in Science Teaching, San Francisco, CA.

- Greca, I. M., & Moreira, M. A. (1997). The kinds of mental representations- models, propositions and images- used by college physics students regarding the concept of field. *International Journal of Science Education, 19*, 711 - 724.
- Guisasola, J., Almudi, J., & Zubimendi, J. (2004). Difficulties in learning the introductory magnetic field theory in the first years of university. *Science Education, 88*, 443-464.
- Guth, J., & Pegg, J. (1994). First-year tertiary students' understandings of iron filing patterns around a magnet. *Research in Science Education, 24*, 137-146.
- Harrison, A. G., & Treagust, D. F. (1996). Secondary students' mental models of atoms and molecules: implications for teaching chemistry. *Science Education, 80*, 509-534.
- Hickey, R., & Schibeci, R. (1999). The attraction of magnetism. *Physics Education, 34*, 383-388.
- Lehrer, R. (2009). Designing to develop disciplinary dispositions: Modeling natural systems. *American Psychologist, 64*, 759-771.
- Maloney, D. P., (1985). Charged poles? *Physics Education, 20*, 310-316.
- Ravanis, K., Pantidos, P., & Vitoratos, E. (2010). Mental representations of ninth grade students: The case of the properties of the magnetic field. *Journal of Baltic Science Education, 9*, 50-60.
- Saglam, M., & Millar, R. (2006). Upper high school students' understanding of electromagnetism. *International Journal of Science Education, 28*, 543-566.



# TOWARDS EFFECTIVE TEACHING OF WEIGHT AND GRAVITATION AT SCHOOLS

Hana Stein and Igal Galili  
*The Hebrew University of Jerusalem*  
[steinhana@gmail.com](mailto:steinhana@gmail.com) [igal@vms.huji.ac.il](mailto:igal@vms.huji.ac.il)

## Abstract

Several researches demonstrated the problematic status of teaching gravitation and weight and students' knowledge of these concepts. We introduced novel teaching using Thinking Journey format. This study presents results following the teaching of 141 students of 9th grade. We followed up the conceptual change of students, especially regarding concept definition of weight and its application, testifying about the ability of middle school students to distinguish between *weight* and *gravitational-force* as well as comprehend and analyze novel physical situations. The data were analyzed quantitatively and qualitatively. Comparison with 91 high school physics students, although of limited validity, indicated certain advantage of students' conceptual understanding of the subject.

## Background

Concept learning is central in physics education (e.g. Arons, 1990; Novak, 1991). They often need clarification for teaching and learning (Duit et al., 2005). This work deals with the concept of *weight*, possessing controversy and confusion especially with respect to the gravitational-force. Some authors define weight as the gravitational-force (e.g. Young & Freedman, 2004) and others – as weighing result (e.g. Marion & Hornyack, 1982). Different countries make different preferences: for example, in the US the gravitational definition prevails, and in Russia – the operational one. The modern philosophy of science requires two complementary definitions – operational and nominal (Margenau, 1950). Students and teachers of physics are often confused in understanding the concepts of weight and gravitation (Ruggiero et al., 1985; Morrison, 1999; Galili, 2001; Galili & Lehavi, 2003; Gonen, 2008).

The need for continuity and consistency in teaching concepts was stated widely (K-12 curriculum), for instance, in the Project 2061 (AAAS, 1985). However, teaching of weight often suffers of disruption, when weight is defined operationally at elementary school and gravitationally – at high school. The two frameworks of weight instruction create an interesting area of investigation – teaching weight in the *middle* school, where the initial operational knowledge is upgraded by theoretical gravitational one.

Another problem is the relationship between weight and the gravitational-force. After the introduction of equivalence principle by Einstein (1916/1923) it became clear that weighing results cannot uniquely indicate gravitational-force and the need to split between weight and gravitation was understood (Reichenbach 1927). Some physics educators (e.g. Marion & Hornyack, 1982) did not hesitate to split between the gravitation (the force of attraction) and weight (weighing results) in introductory physics course. This approach to weight is known as operational approach and is associated with modern physics. Others (e.g. Young & Freedman, 2004), trying to simplify introductory course modified the old gravitational definition introducing *true weight* (gravitational-force) and *apparent weight* (weighing result).

## **Rationale**

The intention of this study was to check a possibility of operational instruction of weight at middle school. The idea of the new teaching is involve situations, which may promote students understanding of weight. Unlike the regular instruction, which often appeals to the on ground reality on the Earth surface, the experimental teaching involved situations in distant and irregular environments: on the Moon, orbiting spaceship, super-high tower, etc. On our days, students can observe many of them in media (such as weightless astronauts), and they do not seem weird, but remain attracting curiosity. The new environments of learning may promote distinction between weight and the gravitational-force.

The study incorporated two phases. In the pilot study, we applied the new instruction to a small group of 14 students of the 7th grade. We obtained detailed information of the conceptual change occurring in the students facing the environment on the Moon and in a satellite, and we could design the instruction to a wider population at the second phase. Then, we evaluated students' knowledge and inferred regarding the ability of middle school students to distinguish weight and gravitation concepts. We also checked whether emphasizing the role of measurement – the operational approach – helps students to comprehend and analyze physical situations.

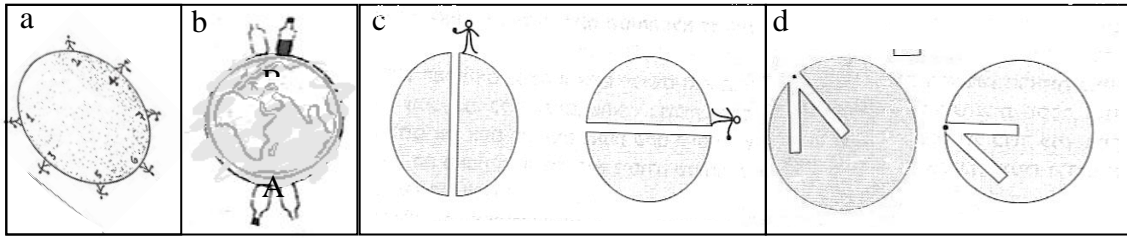
## **Methodology**

We applied experimental teaching to a sample of 141 students of the 9th grade in a public school of Tel Aviv: two classes in a year (about 35 students in a class) during two years. The students had no background in the subject.

The teaching method at both stages was Thinking Journey (Schur & Galili 2009). Thinking Journey presents a special form of dialogic teaching in which students perform imaginary journey using pictures and video clips representing various perspective of the considered concept: on the Moon, in a spaceship, etc. In the guided discussions students account for the situations and teacher mediates between scientific and naïve ideas. Each environment promotes certain aspect of the goal concept. All together, they create a space of learning (Marton et al., 2004). Students gradually construct the scientific concept discerning common and different elements in several appearances. One of us taught and instructed two other teachers to apply the experimental teaching.

Teaching included seven sessions (90 minutes each) in accordance with the regular program (the topic "mass weight and forces"). The topics included were: (1) Moon environment and comparison between gravitation on the Earth and Moon; (2) An outside view on the "Earth-Moon" system and discussion on the "up-down" direction; (3) Acquaintance with Newton's law of gravitation and its applications; (4) Acquaintance with the state of weightlessness in spaceship environment; (5) Discussion on the concept of weight and standard weighing; the environment of the imaginary rotating space station; (6) Problem solving meeting; (7) Excuse to the history of weight and gravitation.

Pre-instructional test given to the experimental group included nine questions about the "up-down" direction and the concepts of weight and gravitation. Inclusion of the up-down concept into the scope of our research was due to the power of this concept to direct the thought of students to the issue of weight-gravitation and to reveal their pertinent conceptions in less formal context. This feature was demonstrated in previous studies (e.g. Nussbaum, 1979).



**Figure 1:** Figures from the pre-test

Some questions used sketches (Fig. 1): (a) draw the direction of falling of a stone thrown from different places on the Earth; (b) mark water filling the bottle at the North pole, and water level in it at the South pole; (c) draw the path of a stone falling through an imaginary hole through the Earth; (d) select the tunnel in which a stone would fall.

An open qualitative questionnaire (25 questions) was used in the post-test. The first 22 questions asked about weight and the gravitational-force in a variety of physical conditions including movements, media, and locations. Three more questions asked to define weight, the gravitational force and their relationship.

The validity of the post-test was determined in the discussion with three physics teachers, and the reliability and internal consistency was established (Cronbach  $\alpha = 0.896$ ).

The post-instructional test was applied to the experimental group and 91 high school physics students (11th and 12th grades), who were taught in accordance with the regular curriculum (no clear distinguishing between weight and gravitation). The comparison between the groups indicated the effect of the operational definition of weight and the ability to comprehend and analyze physical situations.

The rich data was analyzed quantitatively (statistically) and qualitatively (by the scheme-facets of knowledge – Galili & Hazan, 2000).

## Findings

### *The pre-instructional test*

We may illustrate some findings from the pre-instructional test. In the following, there is a distribution of students' ideas:

- |  |     |
|--|-----|
| (a) <i>One floats on the moon and moves there as if swimming because there is no air</i>   | 58% |
| (b) <i>If you throw a ball there, it flies up and disappears in space or it will stay up since there is no gravity in space and nothing would bring it down.</i> | 67% |
| (c) <i>There is gravity on the Moon; I heard that there is gravity outside the Earth.</i>  | 53% |
| (d) <i>There is no gravity on the Moon but it keeps bodies because it is big.</i>  | 47% |
| (e) <i>There is no weight on the Moon. Everything is flying there.</i>   | 40% |

Students' conceptions about up-down included many naïve ideas: 12% of the students marked the direction of falling to the bottom of the page (instead of the

direction to the ground; 30% of the students wrote that the bottle at the south pole will lose water; only 11% wrote that the ball falls through the whole tunnel to the opposite side; 30% marked the ball continues to fall down after crossing the Earth (or floating after); 40% of the students selected incorrect channel (only 33% marked the right channel).

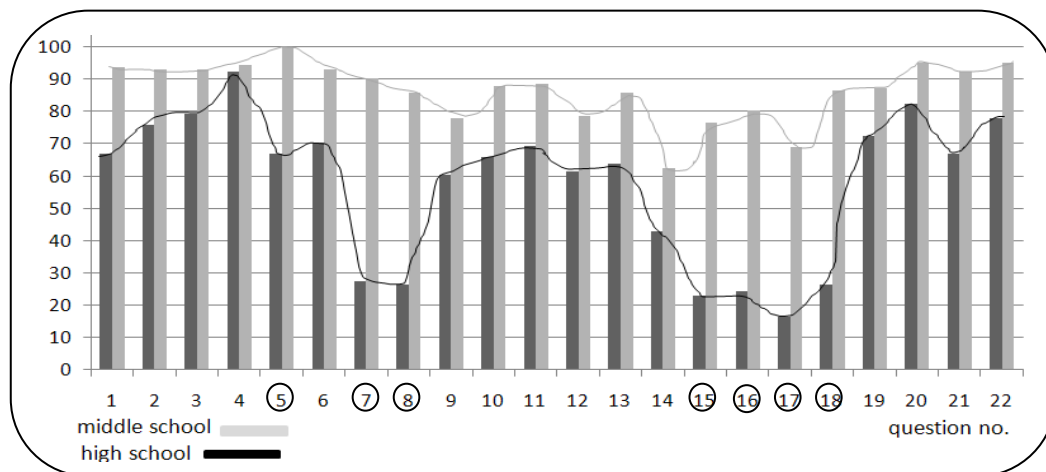
### *The post-test*

The general results of the experimental and the high school groups (Table 1) show an advantage of the experimental group.

**Table 1:** Statistics indices of the correct answers (22 questions)

	N	Mean	Median	Mode	Std. Deviation	Min	Max
Middle school	141	19	20	22	3.95	4	22
High school	91	13	13	12	4.10	3	22

Figure 2 shows the distribution of the correct answers in both groups. The most significant differences between the two groups happened in seven questions dealing with free falling.



**Figure 2:** Distribution of correct answers among the questions as provided in the two groups (middle and high school students).

Questions 23-25 informed of significant differences. The most distinctive was regarding the concept of weight: 83% of our students showed operational conception of weight versus 20% in high school; 15% showed gravitational conception of weight versus 52% in high school; the rest did not answer.

The correlation between students' weight conception and correct answers showed that the students with operational conception had more correct answers (91% versus 70%). The difference was particularly significant within experimental group.

In the qualitative analysis, we elicited first the facets of knowledge and grouped them around representative schemes. Together they represented the structure of students' knowledge: 9 schemes of gravitation, 10 schemes of weight and 3 schemes of up - down direction. We leave the detailed description to the more comprehensive publication. Here we mention that the salient feature of the knowledge structure was



This role of falling indicates operational approach of considering the situation according to falling bodies (or "no falling") as its salient feature. Falling of bodies was used by the middle school students in their discussions about the meaning of weight and gravitation, as well as up-down direction. Lack of falling indicated to many the lack of weight; falling indicated the existence of gravitation.

### **Conclusions and implications**

We were evident to significant conceptual learning of the students involved in the experimental instruction and may infer regarding several pedagogical issues.

- Middle school students instructed in the operational approach to weight could understand the conceptual subject not less well and often better than high school students instructed in other way. We got qualitative and quantitative evidence of that, in the way students treated different physical situations.
- The operational definition of weight was found possessing a distinct advantage, especially in the situations involving falling of bodies (such as satellite environment, and especially, the imaginary rotating space station). Thus, in addressing the orbiting satellite, 90% of middle school students (versus 27% in high school) conceived the astronauts weightless (zero weighing result) while admitted that the gravitational-force remained active.
- The operational definition of weight appeared being closer to the naive knowledge of weight as the heaviness of things measured by weighing. It allows refinement (instead of replacement) of the naïve concept, making conceptual change easier.
- *Falling* plays decisive role in students' considering the concepts of weight, up-down direction and the gravitational-force. Therefore, the state of falling may be used in teaching as anchoring (or bridging) concept, which can encourage conceptual separation of weight and gravitational-force and lead to the operational meaning of weight.
- Thinking Journey presents an appropriate pedagogy to lead students towards understanding of weight and gravitation. Multiple perspectives of representative situations, supported by adequate images, present a powerful tool of teaching, allowing construction of the required conceptual knowledge.
- Students' engagement, interest and attention, preserved through the whole instruction. Students expressed them in verbal as well as in written comments. This testifies for the affective power of the teaching method.
- Unlike the common view, the success of teaching may be attained through considering distant (irregular) environments or extreme cases. Those can elucidate the learners and stimulate their conceptual change;
- While addressing orbiting spaceship, some students identified two perspectives of external and internal observers and tried to relate this to the concept of weight. This fact may indicate a chance to consider the role of observer in physics. Further research is required to check whether the distinction between weight and gravitation can be related to the framework of multiple observers which belongs to the more advanced curriculum of mechanics.
- Teaching variety of modern environments (satellites, astronauts, weightlessness, microgravity) matches the rapid scientific and technological progress and attracts students to physics classes.

- The findings of this study testify that "not only the best – can". Using the proper approach and method of teaching allows much wider population of students to study physics, starting from the middle school.

## References

- AAAS (1985). (American Association for the Advancement of Science). *Science for All Americans*. Oxford University Press, New York.
- Arons, A.B. (1990). *A guide to introductory physics teaching*. Wiley, New York.
- Duit, R., Gropengießer, H., & Kattmann, U. (2005). Towards science education research that is relevant for improving practice: The model of educational reconstruction. In H.E. Fischer, (Ed.) *Developing standards in research on science education* (pp. 1-9). Taylor & Francis, London.
- Einstein, A. (1916/1923). *The Foundation of the General Theory of Relativity in the Principle of Relativity* (pp. 111-164). Dover, New York.
- Galili, I. (1993). Weight and Gravity: teachers' ambiguity and students' confusion about the concepts. *International Journal of Science Education*, 15(1), 149-162.
- Galili, I. (2001). Weight versus gravitational force: Historical and educational perspectives. *International Journal of Science Education*, 23, 1073–1093.
- Galili, I. & Bar, V. (1997). Children's operational knowledge about weight. *International Journal of Science Education*, 19 (3), 317-340.
- Galili, I. & Hazan, A. (2000). The influence of a historically oriented course on students' content knowledge in optics evaluated by means of facets - schemes analysis. *American Journal of Physics*, 68 (7), S3-15.
- Galili, I. & Kaplan, D. (1996). Students' Operation with the Concept of Weight. *Science Education*, 80(4), 457-487.
- Galili, I. & Lehavi, Y. (2003). The importance of weightlessness and tides in teaching gravitation. *American Journal of Physics*, 71(11), 1127-1135.
- Galili, I. & Lehavi, Y. (2006). Definitions of physical concepts: A study of physics teachers' knowledge and views. *International Journal of Science Education*, 28(5), 521–541.
- Gönen, S. (2008). A Study on Student Teachers' Misconceptions and Scientifically Acceptable Conceptions about Mass and Gravity. *Journal of Science Education and Technology*, 17, 70-81.
- Gurel, Z. & Acar, H. (2003). Research into Students' Views about Basic Physics Principles in a Weightless Environment. *Astronomy Education Review*, 2(1), 65-81.
- Keller, F.J., Gettys, W.E., & Skove, M.J. (1993). *Physics* (pp. 99-100). McGraw Hill, New York.
- Margenau, H. (1950). The Role of Definitions in Science. In *The Nature of Physical Reality* (pp. 220-244). McGraw-Hill, New York.
- Marion, J.B. & Hornyack, W.F. (1982). *Physics for Science and Engineering*. Saunders New York, Vol. 1, p. 129.
- Marton, F., Runesson, U. & Tsui, A.B.M. (2004). The Space of Learning. In F. Marton, & A.B.M. Tsui (Eds.), *Classroom Discourse and the Space of Learning* (pp. 3-40). Lawrence Erlbaum, Mahwah, New Jersey.
- Minstrell, J. (1992). Facets of students' knowledge and relevant instruction. In R. Duit, F. Goldberg, & H. Niedderer (Eds.) *Research in physics learning: Theoretical issues and empirical studies* (pp. 110-126). Institut für die Pädagogik der Naturwissenschaften Kiel, Germany.
- Morrison, R.C. (1999). Weight and Gravity - The Need for Consistent Definition. *The Physics Teacher*, 37, 51-52.
- Novak, J. (1991). Clarify with concept maps: A tool for students and teachers alike. *The Science Teacher*, 58(7), 45-49.
- Nussbaum, J. (1979). Children's conception of the Earth as a cosmic body. *Science Education*, 63(1), 83-93.
- Schur, Y. & Galili, I. (2009). A Thinking Journey: A New Mode of Teaching Science. *International Journal of Science and Mathematics Education*. 7, 627-646.
- Young, H.D. & Freedman, R.A. (2004). *University Physics* (pp. 459-460). Pearson, Addison Wesley, New York.

# **Inquiry-based physics education in French middle school**

Jean-Marie Boilevin IUFM Aix-Marseille, Université de Provence – UMR ADEF, France  
Ludovic Morge Clermont Université, Université Blaise Pascal, IUFM Auvergne – PAEDI, France  
Alice Delserieys IUFM Aix-Marseille, Université de Provence – UMR ADEF, France

## **1. Responses to the students' loss of interest in science and / or science studies**

Developed countries are facing a long-standing phenomenon of students deserting science studies. In response, many international reports have been published to improve science education in compulsory schooling (High Level Group, 2007). They often encourage important evolutions regarding the final objectives for science education (Osborne & Dillon, 2008). Thus an understanding of the nature of science and its practices in classrooms holds a significant position, as does the learning of scientific knowledge. These changes have shaped the role of laboratory activities, leading to science teaching through scientific inquiry in the 60s in the United States (Schwab, 1962). They led to the development of new curricula in the United States from the early 90s (Science for All Americans (AAAS, 1989) ; National Science Education Standards (NRC, 1996)), and more recently in Europe (Eurydice, 2006). These curricula aim at emphasizing a scientific literacy for all, giving a broader image of scientific methods. They promote teaching methods with activities of higher cognitive level where students are given more autonomy by using more open tasks. Hands on activities or scientific inquiry are often used in order to increase students' motivation and interest in science. They use (not always explicitly) specific teaching models such as socio-constructivism, calling upon real-life contexts. This implies a change from activities focused on conceptual or manipulative learning often involving stereotyped methods, to open activities based on methods of inquiry with questions to be addressed, hypotheses, etc.

In France, inquiry-based science education (IBSE) was introduced with “La main à la pâte”, a program launched by the French Academy of sciences in 1996. Tasks relating to scientific inquiry are encouraged, aiming to develop a scientific literacy for all and raise students' interest in science. In 2000 a large national renovation plan in science education aimed to generalize IBSE in primary school. As for secondary education, several French reports (Bach, 2004 ; Académie des sciences, 2004 ; Rolland, 2006) highlight the need to change the way experimental science is taught. Considering the current students in middle school and high school, these reports advise teaching methods that are less frontal and allow students to be more active (intellectually and manually). In this context, French curricula first evolved in 2005 for middle school to encourage inquiry-based approaches in natural sciences, technology and mathematics. In order to give coherence to the curricula and the different disciplines, IBSE is presented as the method of teaching to prioritize so that “pupils construct their own knowledge” (open translation, B.O., p. 4).

Recent research studies analyze these new directions. Some are more concerned with the explicit meaning of IBSE in curricula. Others intend to evaluate the effect of such teaching procedures on pupils' learning and teaching practices. The benefit of IBSE on pupils was shown, both in terms of scientific knowledge acquisition (Hofstein & al., 2005 ; Wu & Hsieh, 2006) and regarding their attitude towards science (Gibson & Chase, 2002). However, other studies show that students need time to adapt to the new type of situation introduced with



IBSE (Holbrook & Kolodner, 2000). Windschilt (2003) offers an interesting perspective on this matter. He defends a progressive development of scientific competence for inquiry over several years by introducing open tasks progressively.

As part of their studies, researchers in science education in France are led to design teaching units. Some of them can be considered as inquiry based teaching units and put into practice in classes. In this paper, we present and analyze several examples of these teaching units to highlight the diversity of IBSE. The analysis allowed us to bring out a structure shared by all of these teaching units. The model we define also allows one to define criteria to identify IBSE approaches from within the wide range of teaching strategies.

## **2. Modelling inquiry-based learning sequences resulting from research in teaching of physical sciences**

### ***Modelling using a 'series of inter-related tasks'***

In this research, we gathered together fifteen Inquiry-Based Teaching Units (IBTU) resulting from research in physical sciences teaching. Several types of teaching units were analyzed : problem solving, open problem solving, PACS (Prevision Argumentation Confrontation Syntheses), games or other out-of-school contexts ('adidactic'), modeling etc.(Morge & Boilevin, 2007).

These all differ from one another, both in terms of their nature and the order of the tasks given to students. They also privilege an epistemological aspect (modelling, PACS) or dimensions that are related to the method of teaching physics (problem solving, games or other out-of-school contexts). On the other hand, they all aim at giving value to the construction of knowledge by the pupil. They also share a common structure that we have called a structure of a '*series of inter-related tasks*'. Indeed, these teaching units present the common characteristic of setting pupils a succession of tasks. Here, the word 'task' has been chosen in relation to work psychology where there is a traditional distinction between what has to be done (the task) and what is actually done (effective task or action) (Leplat & Hoc 1983). The nature and order of the tasks are justified because they strive to achieve the goal of the inquiry. We choose to talk about '*series of inter-related tasks*' because in all of the sequences analyzed, the areas of knowledge produced during a task T are then used in task T+1, which in turn are used in task T+2 etc. For example, these tasks may consist of : Designing an experimental protocol ; Predicting the result of an experiment ; Recollecting experimental results ; Building a model of a phenomenon ; Building a model of an everyday life situation ; Observing a phenomenon ; Establishing connections between model and phenomenon ; Explaining a phenomenon ; Explaining a discrepancy between a predicted result and an observed one...

Our analysis of the fifteen IBTU led us to propose a model for any IBTU. This model must be used for what it is, a tool to analyze, compare, choose, design and conduct inquiry based teaching units. It does not constitute a step by step procedure that has to be strictly followed. It is essentially a tool that allows one to be explicit about choices made during preparation and application of IBTU. Thus, it can be regarded as a tool to question one's teaching habits.

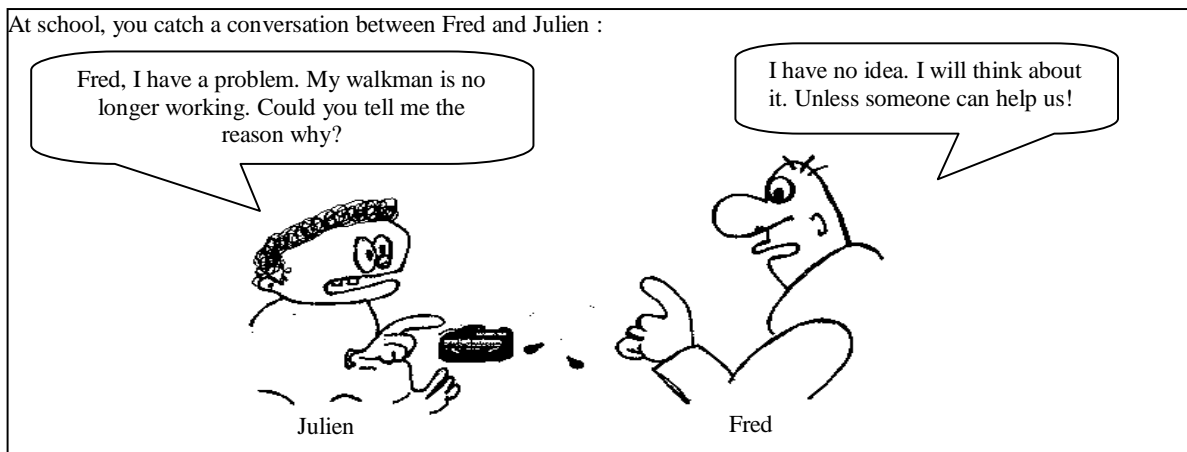
The way that an IBTU takes place can be represented through a number of actions (fig. 1) indicated by letters (A, B, C, D, etc.). When events happen simultaneously, they have the same letter, with a different number (D1, D2, D3). This model (Morge, 2008) compliments a previous one (Morge 2007, p. 40) with two new courses of action (D3 and E).

***Inquiry goal and task construction***

In order to illustrate different ways of building inquiry tasks, we will concentrate on the two primary actions of an IBTU and the link between them (fig. 1). The first one is the definition of the goal of the inquiry (action A). In the second one, students can be guided to specify the succession of tasks (action B).

For each inquiry scenario, the goal to be attained gives meaning to all of the tasks. It is the motor and organizer of the inquiry. The order and nature of these tasks are justified by the goal that is to be attained. The goal can be determined by the teacher. This is the case in example 1, where the aim is to explain why Julien's walkman does not work. The succession of tasks is to be define by the pupils.

**Identification of battery terminals  
1<sup>st</sup> part**

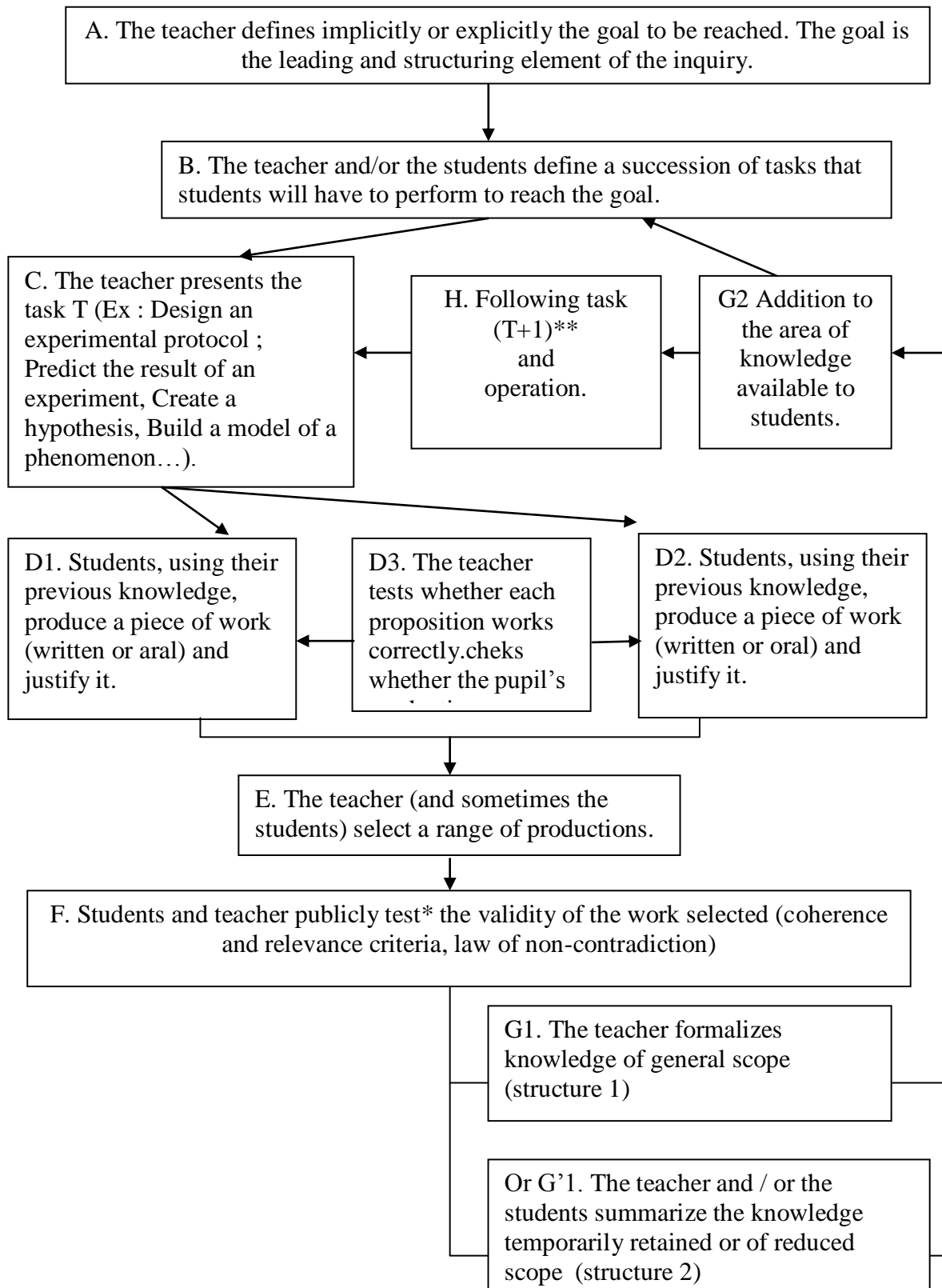


In your opinion, what is the reason why Julien's walkman is not working?.....

Ex. 1 : Part of an inquiry-based teaching unit, grade 7, <http://spcfa.ac-creteil.fr/spip.php?article55>

But the teacher may involve the students in determining the goal. To do this, he may use a situation that will instigate pupils activity. Such a situation need to lead pupils to raise their own questions. It may hinge on the analysis of an image, for example (Courtilot, 2006) or on an intriguing observation (Larcher & Peterfalvi, 2006). Amongst all of the subsequent questions, the teacher and the pupils define the question or questions they are going to tackle, and obtaining answers to the questions becomes the goal (A fig. 1). In other cases (eg. Larcher et al., 1990) the teacher may act alone in determining the goal to be attained and the tasks that allow this to happen leading to guided IBTU.

**Fig. 1 : Model of actions achieved during an inquiry-based teaching unit**



\* Potentially problematic action. A task can be considered a problem when a contradiction cannot be raised without challenging the student's previous knowledge. In other words, a problem-based situation occurs when students encounter a contradiction that challenges their preconceptions.

\*\* A task is fully completed when going through the loop from action C to H.

### 3. Criteria suggestions to identify an Inquiry-based teaching unit

The model of '*series of inter-related tasks*' detailed above provides unity in the description of a wide variety of IBTU. Certain characteristics of these units apply to all of them. These common characteristics can serve as a basis for providing criteria to allow one to identify an IBTU amongst several different teaching units.

From our previous model, a list of three minimal criteria can be proposed. We believe that a teaching unit is inquiry-based if :

- 1) the pupil learns one piece of scientific knowledge or more during the unit...
- 2) ...by accomplishing tasks that are not only experimental ...
- 3) ... and by participating in finding out whether other pupils' work is valid; in other words, by participating in making the choice from several methods, hypotheses, experimental protocol, explanations, models with relevant arguments.

These criteria can be seen as a first level of reflection to distinguish an inquiry scenario from another teaching scenario. If the three criteria are met, a teaching unit can be considered as an inquiry-based teaching unit. We are not claiming to present the one and only definition of an IBTU, but a definition using a range of criteria useful to analyze IBTU. This definition incorporates a wide range of IBTU (pre-defined task inquiry, pre-defined goal inquiry, previously undefined aim inquiry, open-ended problem-solving inquiry, PACS situation, modelling activity...).

From the three initial criteria, and the model presented in figure 1, we have derived more detailed criteria summaries in table 1. The detailed version is also available (Morge & Boilevin, 2007).

Table 1 : Summary of criteria to characterize Inquiry-based Teaching Units (IBTU).

Criteria to	identify an IBTU	differentiate between IBTU
Triggering situation starting the teaching unit.		<b>X</b>
The teaching unit includes a ' <i>series of inter-related tasks</i> ' carried out by students.	<b>X</b>	
Students participate in the definition of tasks.		<b>X</b>
There is at least one problematic task (a task where students face a contradiction that can only be raised if they challenge their preconceptions).		<b>X</b>
Students design productions (work) corresponding to the tasks.	<b>X</b>	
Students are given means of participating in the testing of the work produced, and actually participate.	<b>X</b>	
The testing of productions is done by investigating their validity, their coherence (and not a correspondence between productions and teachers scientific knowledge).	<b>X</b>	
In the tasks, students are learning new knowledge and not only re-using previous knowledge	<b>X</b>	

Students also achieve conceptual tasks and not only empirical ones.	<b>X</b>	
The teaching unit has some fun aspects.		<b>X</b>

#### **4. Application of the 'series of inter-related tasks' model to an "adidactic" Inquiry-based teaching unit : The resistors game example**

This is a unit for middle school or high school. It was designed by Robardet (1997). The aim is " *to make pupils understand that an electrical circuit functions as a complex system in which all the components interact and that most importantly, the intensity of the current in the generator loop depends not only upon its own characteristics, but also upon those of the receivers and the way that they are set up within the circuit.* " (Ibid, p 59, open translation). The following equipment is used : a generator, a push button, an ammeter and a lamp are connected in series ; the pupils have five identical ohmic conductors that they can connect to the circuit. To make building and dismantling easier, a perforated board may be used to position the resistors.

The following description uses our successive tasks model.

Aim of the game : To score points by changing the number and/or position of the resistors on the board in order to raise the value shown on the ammeter screen.

Task 1 : First, students play on their own, with another person watching to make sure that they play by the rules. This phase of the game can be considered a task because it leads the student to produce something (a series of circuits) which will be examined by the teacher and/or the students (here, the teacher's role in the test is indirect, since the teacher watches from a distance and only intervenes by setting the rules he gives to the students).

Task 2 : The class is divided into teams of four to six students who play against each other. On a large piece of paper, each team writes down the strategy that they think will win the game, in the form of a succession of diagrams detailing how the resistors are to be set up. These successive diagrams constitute the production that the students have to do for this task. To test the productions, the students and the teacher check that each circuit allows one to obtain a lower resistance than the previous one. In the event of a disagreement, an experimental check is carried out. A point is scored for every successful attempt.

Task 3 : In groups of 4 to 6, the students come up with empirical rules to allow the variations in intensity within the generator loop to be accounted for, as a result of changes made to the resistor setup. These rules constitute the students' productions, which will then be tested by the class. Once again, the test criterion is the law of non-contradiction, since the rules stated by the students must not contradict the strategies that were accepted during the previous task.

#### **1. Conclusion**

The 'series of inter-related task' model presented here constitutes a tool for analysis, comparison, choosing, designing and managing inquiry in physics classes.

Our "definition" of criteria for inquiry-based teaching units seems expansive enough to incorporate a wide range of different teaching units. It should allow teachers to diversify their teaching practices by using inquiry in class, acknowledging the many important aspects of science teaching. At the same time, this "definition" of investigation shows a major heterogeneity of teaching units with regard to the students' position in the building of knowledge, the importance given to reasoning and scientific debate in learning, the importance and nature of the teacher's role in managing these teaching units.

## **Bibliography**

American Association for the Advancement of Science. (1989). *Science for All Americans. Project 2061*. New York : Oxford University Press.

Avis de l'Académie des Sciences sur l'enseignement scientifique et technique dans la scolarité obligatoire, 2004.

Bach, J-F. (2004). Groupe de relecture des programmes du collège. Pôle des sciences. Ministère de la Jeunesse, de l'Education Nationale et de la Recherche.

B.O. Hors Série n°6 du 28 août 2008, p 4.

Courtillot, D. (2006). Utiliser des images pour déclencher un questionnement en sciences physiques, *Bulletin de l'Union des Physiciens*, 886, 887-894.

EURYDICE. (2006). *Science teaching in schools in Europe. Policies and research*. Directorate general for education and culture. European Commission.

Gibson, H.L. & Chase, C. (2002). Longitudinal impact of an inquiry-based science program on middle school students' attitudes toward science. *Science Education*, 86(5), 693-705.

High Level Group on Science Education. (2007). *Science Education now: a renewed pedagogy for the future of Europe*. Commission Européenne. Direction de la Recherche.

Hofstein, A. Navon, O., Kipnis, M. & Mamlok-Naaman, R. (2005). Developing students' ability to ask more and better questions resulting from inquiry-type chemistry laboratories. *Journal of research in science teaching*, 42(7), 791-806.

Holbrook, J. & Kolodner, J.L. (2000). Scaffolding the development of an inquiry-based (science) classroom. In B. Fishman & S. O'Connor-Divelbiss (Eds.), *Fourth International Conference of the Learning Sciences* (pp. 221-227). Mahwah, NJ : Erlbaum.

Larcher, C. & Peterfalvi, B. (2006). Diversification des démarches pédagogiques en classe de sciences, *Bulletin de l'Union des Physiciens*, 886, 825-834.

Larcher, C., Chomat, A., & Méheut, M. (1990). À la recherche d'une stratégie pédagogique pour modéliser la matière dans ses différents états. *Revue Française de Pédagogie*, 93, 51-62.

Leplat, J., & Hoc, J-M.(1983). Tâche et activité dans l'analyse psychologique des situations, *Cahiers de Psychologie Cognitive, L'analyse du travail en psychologie ergonomique* (pp. 49-64), Toulouse : Octares.

Morge L. (2008). *De la modélisation didactique à la simulation assistée par ordinateur des interactions langagières en classe*. Habilitation à Diriger des Recherches, Université Blaise Pascal.

Morge L. (2007). Modélisation des séquences d'apprentissage par investigation issues de la recherche en didactique des sciences physiques et chimiques. In Morge et Boilevin (dir.) *Séquences d'investigation en physique – chimie... recueil et analyse de séquences issues de la recherche en didactique des sciences*. Clermont-Ferrand : scérén, Collection : repères pour agir, CRDP d'Auvergne.

Morge L. & Boilevin J.-M. (Dir.) (2007). *Séquences d'investigation en physique – chimie... recueil et analyse de séquences issues de la recherche en didactique des sciences*. Clermont-Ferrand : scérén, Collection : repères pour agir, CRDP d'Auvergne.

National Research Council. (1996). National Science Education Standards. Washington, DC: The National Academies Press.

Osborne J. et Dillon J. (2008). *Science Education in Europe: Critical Reflections*. A report to the Nuffield Foundation.

Robardet, G. (1997). Le jeu des résistors : une situation visant à ébranler des obstacles épistémologiques en électrocinétique. *ASTER*, 24, 59-79.

Rolland, J.-M. (2006). *L'enseignement des disciplines scientifiques dans le primaire et le secondaire*. Commission des affaires culturelles, familiales et sociales. Assemblée Nationale.

Schwab, J. (1962). The teaching of science as enquiry. In *The teaching of science* (pp. 1-103). Cambridge, MA: Harvard University Press.

Windschitl, M. (2003). Inquiry projects in science teacher education : what can investigative experiences reveal about teacher thinking and eventual classroom practice ? *Science Education*, 87(1), 112-143.

Wu, H.K. & Hsieh, C.E. (2006). Developing sixth graders' inquiry skills to construct explanations in inquiry-based learning environments. *International Journal of Science Education*, 28(11), 1289-1313.

# **Content and Language Integrated Learning in Physics Teaching: Benefits, Risks, Requirements and Empirical Studies**

Claudia Haagen-Schützenhöfer (claudia.haagen-schuetzenhoefer@univie.ac.at)

Martin Hopf

Austrian Educational Competence Centre, University of Vienna

## ***1. Introduction***

Content and Language Integrated Learning (CLIL) is a bilingual teaching method, where content area subjects are taught with a foreign language as a medium of instruction while the first-language plays no or only a very subordinate role. This concept was introduced by the Ministry of Education in Austria in the mid 1990. The two major aims followed by CLIL were first to improve foreign language education, as the output of language teaching showed deficits in communicative competence, and secondly to deepen intercultural learning.

The core idea was CLIL being a flexible concept compared to conventional bilingual school programmes. It can be used in all non language subjects in all school forms on secondary level and its intensity can range from teaching isolated topics in one subject to courses lasting for a school year in one or more subjects.

During the last decade Content and Language Integrated Learning (CLIL) has become quite popular in German speaking countries. An increasing number of schools are offering programs which are based on this bilingual approach in content subjects. However, this trend is not equally true for science subjects, especially not for Physics. Science teachers seem to be quite concerned how their students' subject achievement and motivation are influenced by the use of a foreign language as a medium of instruction<sup>1</sup>. This contribution gives a short overview on research done on CLIL so far. The main part focuses on two studies investigating the effects of language integrated Physics lessons on several levels.

## ***2. Benefits and Risks connected with the CLIL Method***

When discussing benefits and risks connected to CLIL there are two different domains which have to be considered: the aspect of second-language learning and that of content learning.

As far as students' achievement in second-language learning is concerned, quite a number of studies have proved that CLIL offers linguistic advantages. Positive effects on language learning already known from Canadian Immersion programmes were also confirmed in several investigations of CLIL<sup>2</sup>.

Compared to conventionally instructed students CLIL students are significantly more competent in their second-language. They are more fluent and possess a significantly larger active and passive range of vocabulary. Grammar, however, is not significantly influenced by CLIL. As far as pronunciation is concerned, students' achievement depends



on the availability of a native speaker, which echoes a known effect of second-language teaching in general<sup>3</sup>.

Accuracy, on the other hand, is controversially discussed. There are concerns that non native teachers with low qualifications in the second-language might have negative impact on students' accuracy and might hinder their foreign language development in general. There is no empirical evidence for this concern, as there are simply no investigations which test and relate CLIL teachers' foreign language abilities and those of their students.

When focusing on subject specific aspects linked to CLIL, three controversially discussed issues can be highlighted. The first is the influence of CLIL on subject related motivation. Frequently CLIL is said to have a potential to increase students' motivation. Another line of argumentation, however, states that especially weak students or students not interested in languages might get frustrated by the CLIL approach.

Secondly, CLIL might also contribute to a deeper subject understanding due to deeper information processing<sup>4</sup>. It cannot be denied that CLIL lessons are cognitively more demanding than native language instruction. Especially due to the additional code system of the second-language information processing is slowed down. Therefore special teaching strategies and methods are required, which for instance support a recurrent treatment of the core issues of a topic.

Thirdly, CLIL might facilitate the acquirement of solid scientific concepts. The use of a second-language may reduce the risk of mixing up everyday concepts with scientific concepts linked to the same term<sup>5</sup>. When little children acquire their first-language they learn to match words with concepts acquired through everyday experience. When students are instructed in Physics it is very difficult for them to add an extra scientific meaning to an already familiar term. The resulting confusion of scientific and everyday concepts often leads to inadequate ideas about physical phenomena. CLIL, however, makes it easier to acquire scientific concepts since there usually is no temporal gap between the acquisition of a term and the matching scientific concept.

Beliefs of current teaching practice rather than empirically proved arguments were the basis for this collection of ideas concerning the effectiveness of CLIL in the field of content learning. What we know from research shows a different picture. Although several evaluations classify CLIL as successful<sup>1</sup> on the level of content-achievement, a closer examination of these results reveals weak spots. On the one hand the comparison of grades or examination papers of CLIL and non CLIL students, or mere teacher reflection served in the majority of cases as indicators for student's content-achievement. On the other hand most investigations were carried out in subjects like History or Geography, since these are the subjects most frequently using a language integrated approach<sup>6</sup>. So the question arises whether these results can be replicated with standardized knowledge tests or concept inventories and second, whether they can be transferred between two subject (e.g. History and Physics) being rooted in different epistemological traditions and subject cultures.

---

<sup>1</sup> The predicate successful is used here for content achievement that ranks at least as high as achievement by students instructed in their first-language.

### **3. Requirements for a good CLIL Practice**

The guidelines for a good practice of content and language integrated teaching mainly originate from teaching experience and didactical knowledge about second-language learning. Focusing on teacher related aspects of teaching, some of the most prominent factors are discussed in this section.

A main factor for successful content and language integrated teaching is teacher qualification. Teacher qualification does not only entail a certain level of proficiency in the second-language, but also knowledge about the basic mechanisms of second-language learning and instructional requirements associated with students' needs in language integrated learning environments. As already mentioned, CLIL students are clearly subjected to higher cognitive demands. Therefore CLIL teachers must have a large methodological repertoire to meet their students' needs. There are several basic scaffolding strategies teachers need to be familiar with<sup>7-9</sup>:

- Comprehensible input: Additional non verbal representations and input on different sensory channels at the same time.
- Bridging / Prompting strategies: Prevent the breakdown of communication, when students are struggling with what they want to say.
- Code switching: Keeping the first-language to a reasonable limit.
- Language support: Provide lexis and basic language functions relevant for the topic treated.

These scaffolding strategies are predominantly from language teaching. Additionally, CLIL lessons should be informed by the following general didactic principles:

- Alternating levels of abstraction / representation
- Activity based, student centred lesson designs
- Communicative instead of instructive teaching

### **4. Empirical Studies in the field of Physics**

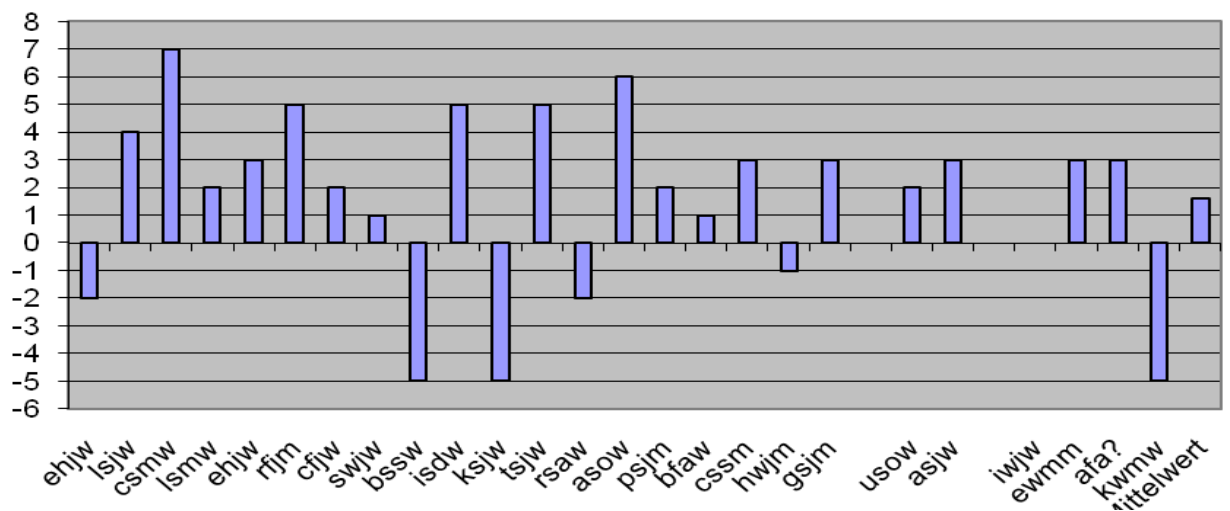
The summary of current research has shown (see above) that little is known about the effects of CLIL on students' content-achievement in Physics. The same is true for the development of motivation in Physics classes instructed with a second-language. In the following section two empirical studies dealing with these issues are presented: The development of individual motivation during CLIL phases in Physics lessons was evaluated in a case study named "Energy Crisis & Solar Power". In addition a field study focusing on the content-achievement of students in introductory magnetism was carried out in the course of a PhD project<sup>10</sup>.

#### **a) Effects on Motivation and Interest**

The case study "Energy Crisis & Solar Power" was done in the course of a cooperative teaching project, where Physics and English lessons were taught coordinated in Year 11 (N=27) of an Austrian High School. During the four months of this project, topics like the nature of light, the electromagnetic spectrum, semiconductors, solar power, greenhouse effect etc. were treated in Physics lessons. Coordinated English lessons were used to provide language support and to treat environmental issues related to the energy topic. For evaluation we used mixed methods, administering pre and post questionnaires, and interviews as well as lessons videos.

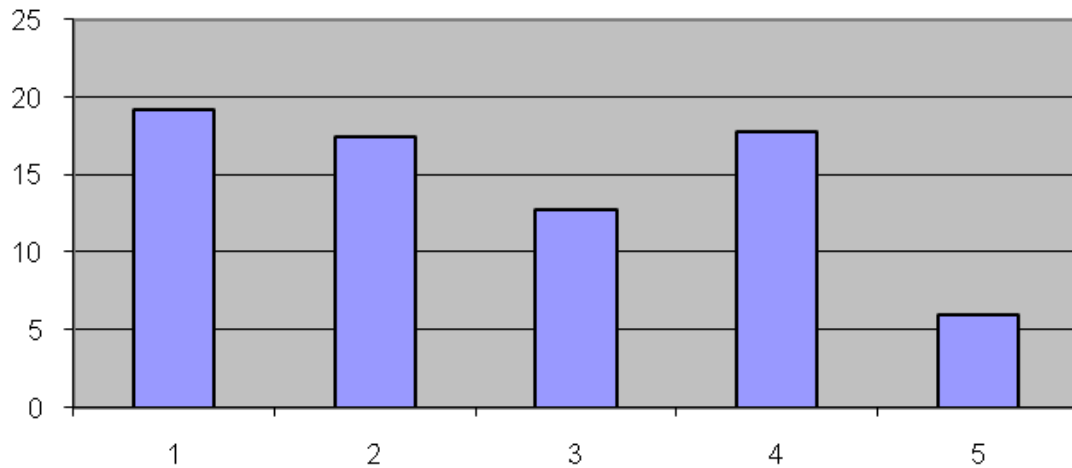
## RESULTS

The impact of CLIL on individual student's motivation was evaluated by pre and post questionnaires using items from the IPN survey on interest<sup>11</sup>. For motivation we used five items with rating scales. The maximum absolute score for motivation was 25, the minimum score 5. The bar graph below (see picture 1) provides a good overview of changes in individual motivation within the four months of the project. The code for each student taking part in the project can be seen on the horizontal axis. The last letter contains information on the participant's sex (w=female, m=male). The vertical axis shows the fall or rise of motivation during the project. The motivational gain was calculated based on pre and post results. One interesting trend can be spotted, when looking at those students with the highest gains and losses in motivation. In both cases they are predominantly girls.



**Picture 1: The development of motivation for the subject Physics during the project (pre scores minus post scores)**

Pre-test scores served as indicator for student's (motivational) preferences for either the subject Physics or English. Each student's motivational profile was compared with his motivational development in the subject Physics during the project. For those cases with a considerable decrease in motivation during the project no correlation could be found to their motivational bias. So, additional interviews were made to reveal motives behind these drops. Two participants blamed either the CLIL approach or the topic itself for their drop in motivation, the rest named private problems including facing the risk of not finishing the class. Analyzing the results for those students with high motivational gains showed in the majority of cases a correlation to a high motivation in the subject English and a medium to low motivation in Physics.



**Picture 2: Motivation scores related to grades in Physics (1= best grade, 4=pass, 5=fail)**

The relationship between motivation and content-achievement in terms of school grades was also analysed for the subject Physics. The bar diagram (see picture 2) relates grades ranging from 1 (=best mark) to 5 (=fail) with the scores achieved in the items on motivation. There is hardly any difference in the motivation score of high achievers (1=best mark) and low achievers who passed Physics (4=pass). So the frequently articulated hypothesis that CLIL necessarily frustrates weak students could not be confirmed. Those who did not pass Physics in the first term showed, however, low motivation. From interviews we know that this group consisted of students with serious problems in several subjects and thus being in general danger of not passing this class. They showed a generally low motivation for school related issues.

#### ***b) Effects on Content Knowledge in Magnetism***

The main research questions of the field study “Introduction into Magnetism” focused on effects of CLIL on content-achievement, gender performance and lesson communication. The investigation was based on a pre and post-test design, with test and control group. The population consisted of 205 Year 11 students from 6 different Austrian High Schools. The 11 classes selected did not have any experience with CLIL. 78 students were instructed in their first-language (control group) and 127 in English as working language (test group).

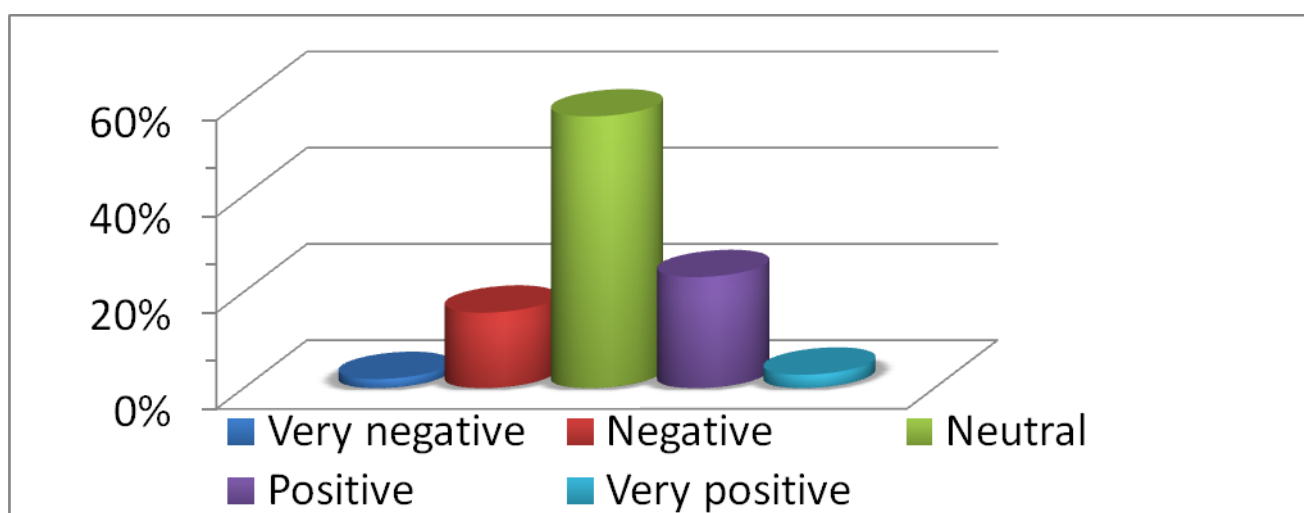
For the treatment an instructional arrangement of four lessons<sup>2</sup> on introductory magnetism was developed based on methodological guidelines for CLIL mentioned earlier. To provide quite similar conditions for all groups and to minimize the influence of variables like teaching methods, teaching style etc. teachers were equipped with a detailed lesson script including didactical, methodical and content related guidelines. The instructional setting, except the language of instruction, was identical for test and control group.

Students’ content knowledge in the field of magnetism was measured with assessment tools developed for this study. The knowledge test consisted of 21 items (6 scales) in the pre-test version ( $\alpha=.716$ ) and of 27 items (8 scales) in the post-test version ( $\alpha=.775$ ). Non cognitive items of the test focused on lesson communication and on personal data. All tests were administered for both groups in their first-language, the pre-test at the beginning of the first lesson of the treatment, the post-test after the last lesson.

<sup>2</sup> In the Austrian educational system a lesson last 50 minutes.

## **RESULTS**

A frequently used argument against CLIL is that it is supposed to influence lesson communication and thus content learning negatively. Students were asked to evaluate the effects CLIL had on the lesson communication in the module on introductory magnetism. As picture 3 shows, the majority experienced a balance between positive and negative effects, although these students had not had any CLIL experience before. For less than 20% negative effects prevailed. Nearly a quarter of the students had the impression that CLIL influenced the classroom communication in a positive way.



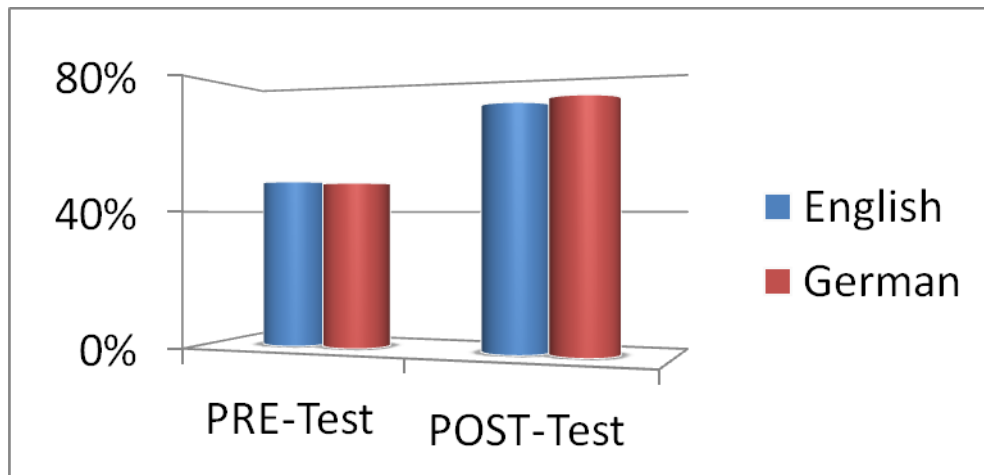
**Picture 3: Effects on lesson communication caused by CLIL**

These outcomes go along investigations in other school subjects. Some authors<sup>5,4</sup> even draw the conclusion that language difficulties might be an opportunity for fostering subject understanding. According to them language difficulties are often – even in the first-language – just symptoms for general problems in understanding. In first-language lesson set ups these problems usually remain under the surface. A second-language, however, provides the necessity for additional phases of intense negotiation of meaning which can support conceptual understanding.

Besides lesson communication, the influence of CLIL on content-achievement is another controversially discussed issue. In this study the subject related performance of both groups was analyzed in two categories; students' self evaluation was checked and measurements were taken by a knowledge test.

In both categories the test and control group showed no significant differences at the pretest stage. According to the comparison of pre and post-test data the subjective learning effects due to the treatment were evaluated as moderate by the test group ( $d=0.7$ ) and as big by the control group ( $d=0.81$ ).

The average number of correctly solved items in the post knowledge test is similar for both groups (see picture 4). Statistical analysis also proves, that there is no significant difference between test and control group. Learning effects achieved by the treatment are medium for both languages of instruction ( $d_{\text{treatmentgroup}}=0.602$ ;  $d_{\text{controlgroup}}=0,640$ ).



**Picture 4: Pre- and post-test results of the knowledge test for the test group (English) and the control group (German)**

The gender analyses of the knowledge test shows again the well known effect, that male students achieve significantly better results than female students. Achievement gains in the post-test showed a small advantage for female students of both groups. This trend could, however, not be confirmed by further statistical analysis. The analysis of covariances revealed that there is no significant difference in learning success between male and female students of both groups, when differences due to prior knowledge are taken into consideration.

## 5. Conclusion

Research on the influence of CLIL on content-achievement is at the very beginning, while language learning advantages are already empirically proved. The two studies presented in this paper may be seen as a first step. The case study “Energy Crises & Solar Power” showed that CLIL positively influenced the motivation of female students with generally medium to low motivation for Physics. For the population of this case study the hypothesis that CLIL leads to a fall in motivation especially of low achievers in Physics could not be confirmed. It, however, is still left open whether the shown development of motivation can also be shown for a bigger population and independent from the topic chosen for instruction.

The field study on magnetism shows that CLIL can be as successful as instruction in the first-language in terms of content-achievement. Although the test group did not have any experiences with CLIL before, they did equally well in the knowledge test. However, these results cannot be generalized for the effect of CLIL on content-achievement in Physics, since they were achieved in a certain age group and with a certain topic.

As far as gender is concerned in both studies male students are again superior in terms of content-achievement. On the other hand, the relative gain in content knowledge is rather equally distributed among sexes. This might be a hint that CLIL can provide a learning environment quite equivalent in terms of gender.

In conclusion it can be said that the studies presented show, that CLIL might have the potential to contribute to a better content understanding and to motivate especially students motivated in languages rather than in Physics. However, more studies investigating different topics and different populations are necessary.

1. G. Abuja and D. Heindler, *Englisch als Arbeitssprache: Modelle, Erfahrungen und Lehrerbildung* (Zentrum für Schulentwicklung Bereich 3, Graz, 1998).
2. C. Dalton-Puffer, "Outcomes and processes in content and language integrated learning (CLIL): current research from Europe," in *Future Perspectives for English Language Teaching*, edited by W. Delanoy and L. Volkman (Universitätsverlag Winter, Heidelberg, 2008), pp. 139–158.
3. M. B. Wesche, "Early French immersion: How has the original Canadian model stood the test of time," in *An Integrated View of Language Development*, edited by P. Burmeister, T. Piske, and A. Rohde (WVT, Wissenschaftlicher Verlag Trier, Trier, 2002), pp. 357–379.
4. A. Koch and W. Bündler, "Fachbezogener Wissenserwerb im bilingualen naturwissenschaftlichen Anfangsunterricht," *Zeitschrift für Didaktik der Naturwissenschaften* **12**, 67–76 (2006).
5. A. Bonnet, *Chemie im bilingualen Unterricht* (Leske und Budrich, Opladen, 2004).
6. J. Hollenweger, K. Maag Merki, R. Stebler, and M. Prusse, "Schlussbericht Evaluation: Zweisprachiger Ausbildungsgang an Mittelschulen," Zürich: ARGE Bilingual (2005).
7. E. Thürmann, "Eine eigenständige Methodik für den bilingualen Sachfachunterricht," in *Bilingualer Unterricht: Grundlagen, Methoden, Praxis, Perspektiven*, edited by G. Bach and S. Niemeier (Lang, Frankfurt am Main, 2002), pp. 75–93.
8. M. Wildhage and E. Otten, *Praxis des bilingualen Unterrichts* (Cornelsen Scriptor, Berlin, 2003).
9. W. Zydati, "Parameter einer "bilingualen Didaktik" für das integrierte Sach-Sprachlernen im Fachunterricht: die CLIL-Perspektive," in *Fachunterricht und Deutsch als Zweitsprache*, edited by B. Ahrenholz (Narr, Tübingen, 2010), pp. 133–152.
10. C. M. Haagen-Schützenhöfer, *Englisch als Arbeitssprache im Physikunterricht*, Dissertation, Karl Franzens Universität Graz, 2005.
11. P. Häußler, W. Bündler, R. Duit, W. Gräber, and J. Mayer, *Naturwissenschaftsdidaktische Forschung: Perspektiven für die Unterrichtspraxis* (Institut für die Pädagogik der Naturwissenschaften, Kiel, 1998).

## **Magical Elves and Formulas as a key to technological inventiveness: The case of non-contact distance measurement**

Dorothy Langley and Rami Arieli

Department of Science Teaching & Davidson Institute of Science Education, Weizmann Institute of Science, Israel

[Dorothy.Langley@weizmann.ac.il](mailto:Dorothy.Langley@weizmann.ac.il)    [Rami.Arieli@weizmann.ac.il](mailto:Rami.Arieli@weizmann.ac.il)

### **Abstract**

Physics students are acquainted with a large set of formulas which they use mainly to calculate numerical answers to end-of-chapter problems. In this paper we aim to demonstrate how purposeful scanning of the stored formulas can help generate inventive ideas for building systems for solving technological problems. The described process takes place within the **Physics and Industry** "Project-Based-Learning" framework for high school physics majors. The students extend their physics and problem-solving knowledge and construct a working model in response to an authentic technological problem in the field of electro-optics. An introduction to the concepts and strategies of **Systematic Inventive Thinking** is used early in the program to enable students to generate creative technological thinking while still in their novice stage. One of the strategies involves "**Magic Elves**" – imaginary creatures which are called upon to perform required functions in the problem solution.

Since many of the student projects involve non-contact distance measurement, we have recently started including this challenge in the early stages of the program. We will describe the instructional sequence we have designed and show several simple inventive applications of physics knowledge.



## **Introduction -The challenge**

One of the challenges facing physics education involves designing learning opportunities which creatively address some of the disturbing results of traditional physics instruction revealed by abundant physics education research during the past 3 decades (e.g. Halloun & Hestenes 1998; Redish et al. 1998; Hammer 2000; Elby 2001; Sherin 2001; Bagno et al. 2008). Some of the predominant weaknesses of prevalent student views are related to the "Reality Link" beliefs about the connection between physics and reality and the "Math Link" beliefs about the role of mathematics in learning physics (Redish et al. 1998). Sherin (2001) states that "*Connections among concepts, formal representations, and the real world, are often lacking after traditional instruction. Students need repeated practice in interpreting physics formalism, and relating it to the real world*". Tuminaro (2004) claims that "*.. the majority of students possess the requisite mathematical skills, yet fail to use or interpret them in the context of physics.*"

Physics knowledge is packaged in compact symbolic expressions known as formulas, which describe the functional relationship between physical quantities. Formulas have an "equation" syntax, with one physical quantity on the left hand side of the "equal" sign and the other quantities on the right. Students regard formulas as primary problem solving tools and often use them as calculation mechanisms, inserting "input" values, and deriving the "output" value. Students' selection of the "suitable" formula is often based on surface features of the problem (Chi et al., 1981; Champagne et al., 1982).

High school physics majors acquire a large collection of formulas from studies in mathematics and physics. A printed formula sheet is often provided as a legitimate memory aid. We claim that students' stored formula repository can be used as a resource for inventing creative solutions to technological problems, provided they can be guided towards thinking "outside the box".

In this paper we will describe the design of an instructional sequence implemented within a project-based-learning framework for high school physics majors. Non-contact distance measurement is required in many of the projects, thus offering a relevant and challenging domain for students to improve the Reality and Math links of their physics thinking. The instructional design involves applying structured thinking skills and activation of formal knowledge from physics and mathematics.

The need for reliable non-contact distance measurement exists in a variety of science and technology fields such as traffic control, robotics, automated manufacturing, vehicle safety, helping the visually impaired, astronomy and astrophysics, land surveying, autonomous navigation, acoustic design and ballistics. In antiquity, geometrical methods were employed for calculating the Earth's radius and the distances to the moon and sun. Different physics principles have been employed to design effective and accurate distance measurement on a wide scale range (e.g. Everett 1989; Carullo & Parvis 2001; Yurish 2009). Methods used for non-contact distance measurement include: Time of flight; Triangulation and Electromagnetic induction. 11<sup>th</sup> grade physics students are unlikely to be familiar with these methods – therefore inventiveness will be required.

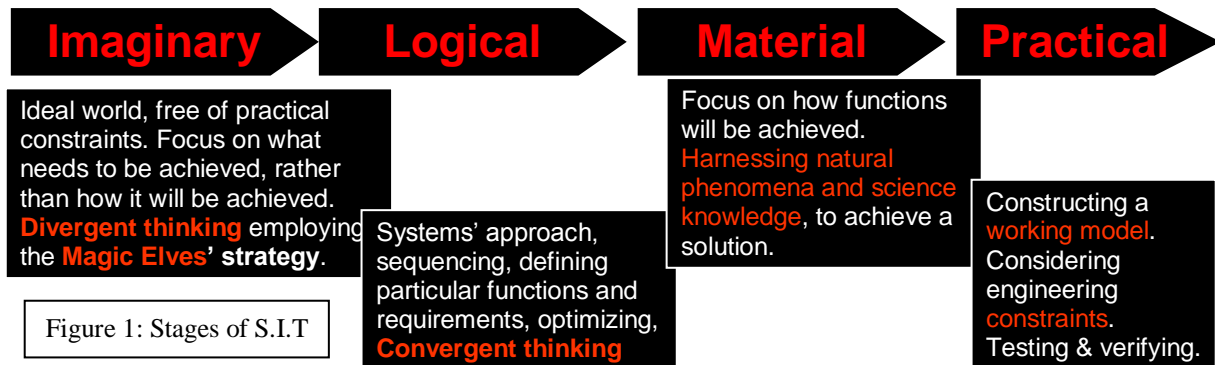
## **The educational context: The Physics and Industry program**

The Physics and Industry (P&I) program is a 15 month, extracurricular, accredited program for 11<sup>th</sup> & 12<sup>th</sup> grade physics majors. The students meet on a bi-weekly basis at the [Davidson Institute for Science Education](#), extending their physics knowledge into the field of electro-optics and constructing a working model in response to an authentic technological problem in the field of electro-optics. Project topics include optical surveillance of restricted premises, assisting blind persons, preventing vehicle collisions, colour recognition etc.

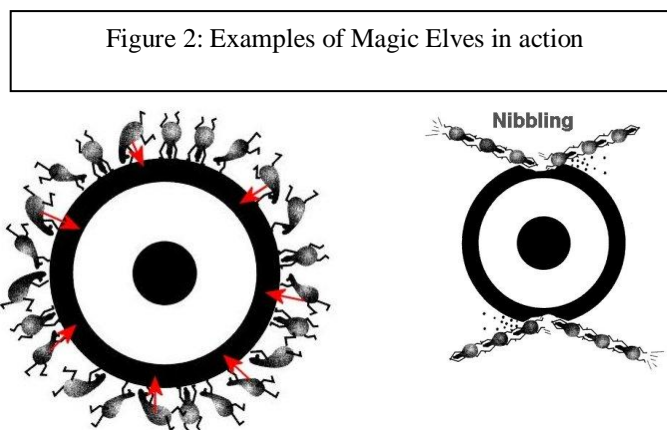
The novice participants have little technical and technological knowledge and skills, and little experience in applying their physics knowledge. An introduction to the concepts and strategies of Systematic Inventive Thinking (S.I.T) is used to allow the students to generate creative technological thinking while still in their novice status.

## Systematic Inventive Thinking (S.I.T)

S.I.T (2005) offers principles and strategies for inventing and designing original & successful solutions for technological problems. Figure 1 shows stages in S.I.T problem solving



One of the useful strategies involves "Magic Elves" – imaginary, obedient creatures which are called upon to perform required functions in the problem solution. The elves carry out relatively simple actions dictated by the designer. They can push, pull, link, hover, shout, point, stomp and run using their hands, feet and body. They do not solve problems by themselves. The Magic Elves are invoked in the initial stages of the inventive solution. At later stages the elves' required attributes lead the designer to identify concrete components and materials that can be used to implement the solution model.



Example (Figure 2): Manufacturing Hazelnut chocolate requires that the hazelnuts are shelled without damaging the inner kernel and without adversely affecting their nutritional value. Magic Elves placed outside the shell can break it by pushing inwards or by nibbling it. Magic Elf diagrams provide a means of visualizing the problem system and suggesting solution methods.

S.I.T is introduced during the first 5-6 weeks of the P&I program in order to develop and practice a creative thinking mode, which is new and exciting for the students. Magic Elves are employed in the context of several technological problem settings such as "Shelling hazelnuts

for chocolate" or "Improved incandescent light bulbs". We also include a "reverse" process "From components to Elves", where the structure of a technological system is shown (e.g. an incandescent light bulb), and students are required to create Magic Elf models that could have been implemented by the given system.

The initial examples of employing Magic Elves involve functions of a qualitative, mechanical nature (pushing/pulling, separating/clinging). Commonplace reasoning, rather than scientific content knowledge is sufficient to create these models. However, more accurate, quantitative functions would be required in the students' selected projects.

### The Distance Measurement instructional sequence

The initial introduction of S.I.T occurs several months before students select their project topics. Although Magic Elves are mentioned in some of the intervening activities, students' ability to apply the early ideas in the context of their selected projects has been unsatisfactory. Since distance measurement is required in many of the students' future projects (e.g. Optical surveillance of restricted premises, extending the safety range for blind persons, preventing vehicle collisions), we decided to trigger student thinking on this issue ahead of time. Our expectations were that this would enhance transfer to the project contexts.

#### Stage 1- Eliciting initial models

The students were required to produce a variety of Magic Elves' ideas and methods for finding the distance between two objects, either of which may be stationary or in motion. The scale of the distance was not specified, and no restrictions of feasibility or practicality were imposed. The goal of having the elves carry out a quantitative measurement meant focusing on the essence of the required measurement (what does it mean to measure distance?) and its quantitative aspects.

Following are some visual examples of Magic Elves' solution models (Figures 3-5):

#### 1. The static ruler model

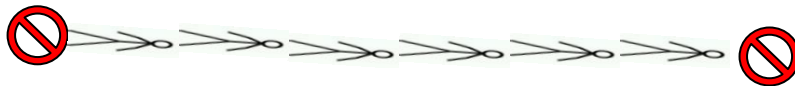


Figure 3: Elves having the same height lie down in a continuous chain until they reach the destination. Counting the number of elves will provide the distance.

This method is an embodiment of the idea that "measurement is a comparison to an agreed unit". This is a contact method, where Elves statically fill the space between the end points. The method of counting Elves or announcing the result is not specified.

#### 2. The dynamic ruler model



Figure 4: An elf jumps from A to B, progressing a constant distance with each jump. Counting the number of jumps will provide the distance.



Figure 5: An elf whose foot size is given progresses from A to B. Counting the number of footprints will provide the distance.

The dynamic models are similar in principle to the static model, but the space between the end points is traversed rather than filled. There is an assumption of an integer number of jumps or steps.

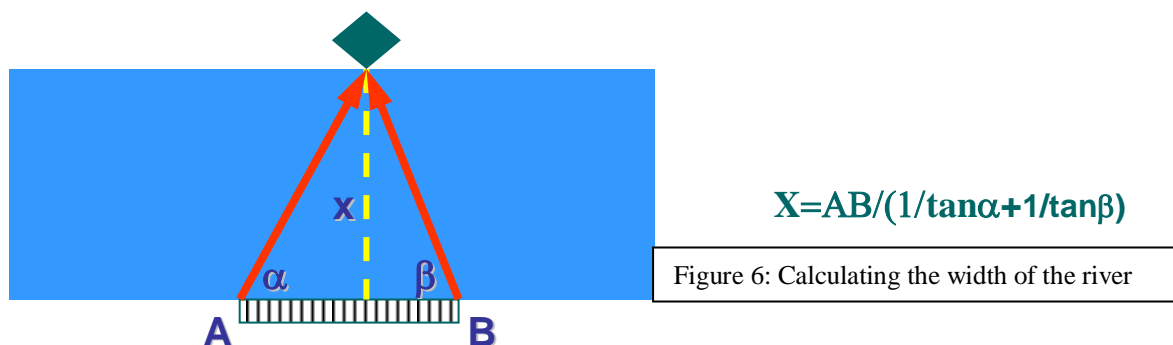
Our analysis of the students' initial Magic Elf models revealed an almost exclusive focus on one-dimensional solutions, often involving material contact. We also found that ideas concerning how the methods could be implemented in reality included measuring the time light or sound would traverse the distance and calculating the distance using the  $x=v*t$  formula. This may stem from students' knowledge of the laser range-finders used by traffic police. Although in principle this is a valid method, it is very difficult to implement since the time intervals involved are very small. Students also mentioned cameras as a means of tracking events and measuring distance, but they regarded the camera as a black-box, without relating the image size to the object's distance from the camera.

### Stage 2: Adding dimensions

The following challenge was presented to the students as a trigger for activating the S.I.T problem-solving tactic of "Adding a dimension".

*"You are standing on the bank of a wide river, and you need to measure its width without physical contact with the opposite bank."*

A class discussion of solution models, including guided hints by the instructors, led to the use of 2-dimensional visualization and mathematical reasoning as shown in figure 6.



Thus, the classic triangulation method of non-contact distance measurement (using a baseline and angles) was introduced, enabling students to utilize simple trigonometric formulas to calculate the unknown distance. Clearly, the formula is reduced to the much simpler form  $x=AB*\tan(\alpha)$ , if  $\beta$  is  $90^\circ$ .

Representing the triangulation method with Magic Elves is the next requirement. Students draw Magic Elf models for the triangulation method, which necessitate their thinking about measuring angles and storing and transmitting information.

### Stage 3 – Activating stored knowledge

In order to activate the "stored formula" resource, students were given the following homework assignment:

- *List all formulas you can find with a length or distance variable.*
- *Express the length in terms of the other variables.*
- *Present ideas how to apply the formulas to design technological methods of non-contact distance measurement.*

Following are some examples of student response (table 1):

Geometry and Trigonometry	Pythagoras theorem Triangle relations Circle formula	$c^2=a^2+b^2$ $a=c*\sin(\alpha)$ ; $b=c*\cos(\alpha)$ ; $\tan(a)=a/b$ $p=2*\pi*r$
Kinematics	Uniform motion Constant acceleration Free fall Projectile range	$\Delta x=v*\Delta t$ $x=x_0+v_0t+1/2at^2$ $\Delta y=1/2gt^2$ $R=V_0^2*\sin(2\alpha)/g$
Dynamics	Elastic force (Hooke's law)	$Fel=-k*\Delta L$
Work & Energy	Work –kinetic energy	$W=F*\Delta x*\cos(\alpha) = \Delta Ek$
Electricity	Electrostatic force Resistance of a conductor	$F_e= k*q_1*q_2/r^2$ $R=\rho*L/S$
Optics	Lens maker's formula Spherical mirror/lens formula Linear magnification	$1/f=(n-1)*(1/R_1+1/R_2)$ $1/f=1/u+1/v$ $m=v/u$

Students should be required to convert some of the formulas involving distance, with which they are familiar, into Magic Elf models. For instance, Hooke's law or the lens formula.

#### Stage 4 – Implementation in project posters

As the program continues the students select their chosen project topics and define the technological problem and requirements of the solution. A poster presentation event takes place about 5 months into the program. It involves displaying a variety of Magic Elf solution models. The effectiveness of the initial exposure to the non-contact measurement issue can be evaluated by the extent creative models based on implementation of physics formulas are manifested in the posters.

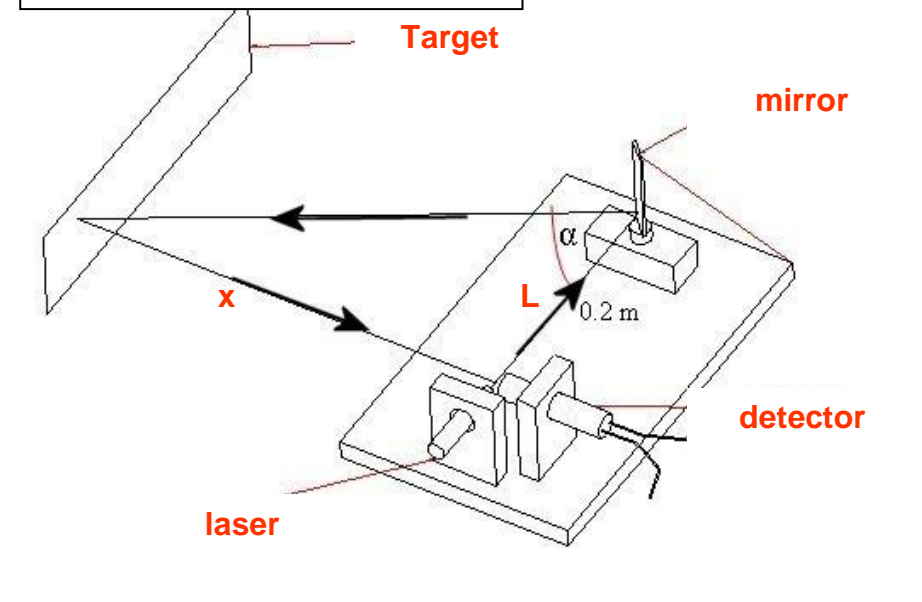
#### Stage 5 – Implementation in Project Models

Following are several examples of creative **electro-optical** methods of non-contact distance measurement that have been implemented in student projects. These methods were mainly designed by instructors and suggested to students. It is hoped that with the early focus on the issue students will be able to arrive at some of these ideas independently.

**1. Laser triangulation** has been used for aiding the blind, locating an intruder and safety in reversing vehicles. Figure 7 illustrates the process:

- A laser light source is directed at a rotating plane mirror, placed at a known distance L.
- The light is reflected, the angle of deflection being  $\alpha$ .
- The reflected beam hits the target, and is reflected diffusely.
- A directional detector collects light at right angles to the original laser beam.
- When the detector fires,  $x= L* \tan \alpha$

Figure 7: Laser triangulation system

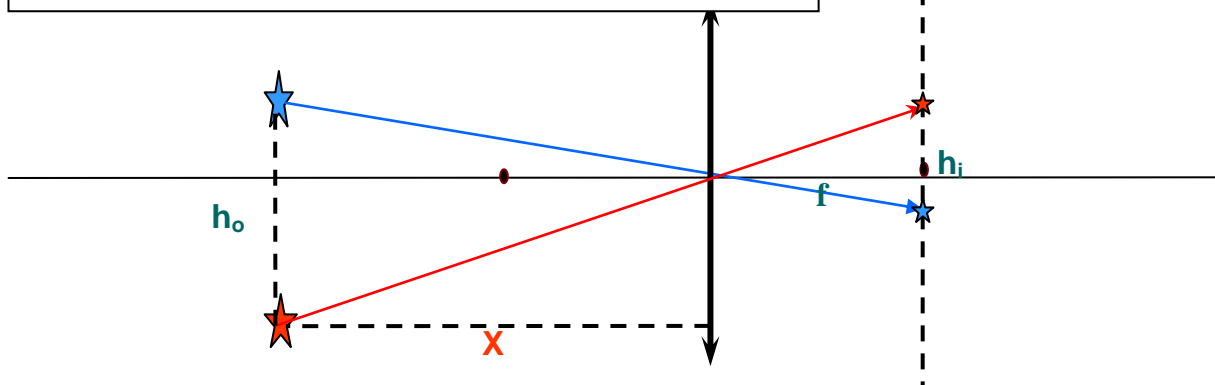


For each target distance  $X$ , a specific mirror position is required. To locate a target at an unknown distance it is necessary to vary the angle until the detector responds. The mirror can be connected to the axis of a step-motor rotating at a given angular rate. By recording the data from the detector it is possible to obtain a time-distance sequence and calculate the relative velocity of the target.

**2. Lens images** can be used for determining the distance to a distant object with a known dimension (Figure 8). The end points of the object either emit light or reflect ambient light. A thin converging lens is placed so that the principal axis is at right angles to the object. The images of the extreme points are created on the focal plane. The object distance  $X$  is related to the distance between the extreme images ( $h_i$ ):  $X = f * h_o / h_i$

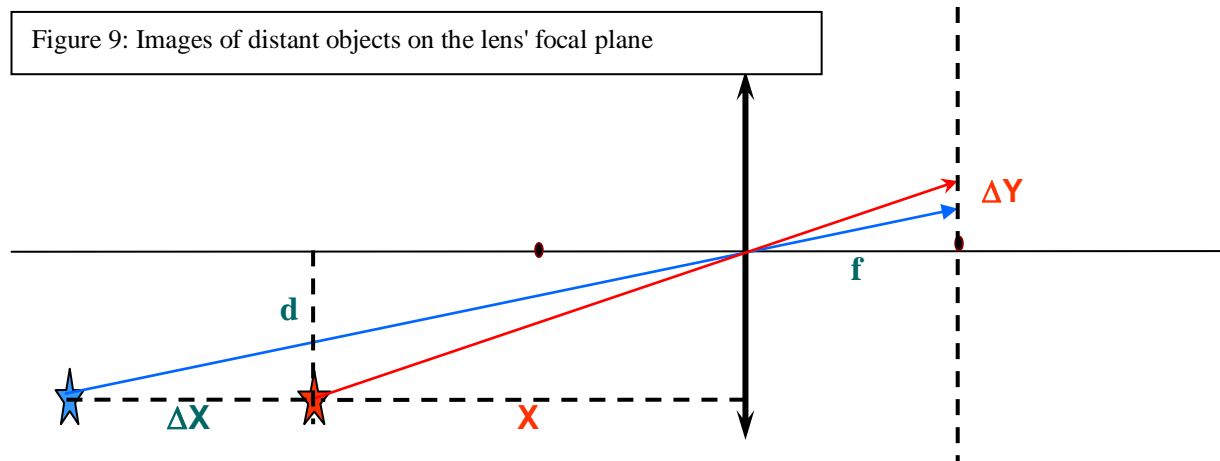
$h_i$  can be measured manually or by using a detector array placed along the focal plane. By identifying the extreme detectors that fire at a given moment, it is possible to measure and record changes in the distance.

Figure 8: Image of distant object on the lens' focal plane



**3. Lens images** can be used for measuring the distance between objects, and for calculating relative velocity (Figure 9). Two distant objects are separated by an unknown distance  $\Delta X$ . A

thin converging lens is placed so that the objects are at positions  $X$  and  $X + \Delta X$ , on a line parallel to the principal axis, at a known distance  $d$ . The images of the distant objects are created on the focal plane at points  $Y_1$  and  $Y_2$ . The further the object, the smaller  $Y$  becomes. The distance ( $X$ ) is related to the image position ( $Y$ ):  $X = d \cdot f / Y$ . This method can allow us to calculate the distance between the objects at a certain moment, or the distance traveled by one object during a given time interval.



## Summary

Sherin (2001) claimed that *"From the point of view of improving instruction, it is absolutely critical to acknowledge that physics expertise involves this more **flexible and generative understanding of equations**, and our instruction should be geared toward helping students to acquire this understanding"*

The problem of "Inert Knowledge" has been addressed repeatedly (e.g. Bereiter & Scardamalia 1985, Renkel et al. 1996) with view to creating learning opportunities with the potential of keeping knowledge alive and available for application for problem solving. We suggest that the instructional sequence we have designed for the non-contact distance measurement context which is based on purposeful scanning of the students' formula repository and the subsequent animation by Magic Elf models can be considered as a means of gainful activation of stored knowledge.

We are seeking to improve the instructional sequence so that more students participate in the process and become able to design problem solutions based on their innovative application of their physics and mathematics knowledge.



## References

- Bagno, E., Berger, H., & Eylon, B. (2008). Meeting the challenge of students' understanding of formulae in high-school physics: A learning tool. *Physics Education*, 43, 75-82.
- Bereiter, C., & Scardamalia, M. (1985). Cognitive coping strategies and the problem of "inert knowledge". In S. F., Chipman, J. W., Segal, & R. Glaser (Eds.) *Thinking and learning skills, Volume 2: Research and open questions* (65-80). Hillsdale, NJ: Lawrence Erlbaum Associates, Inc.
- Carullo, A., & Parvis, M. (2001). An ultrasonic sensor for distance measurement in automotive applications. *IEEE Sensors Journal*, 1(2), 143-147.
- Elby, A. (2001). Helping physics students learn how to learn. *American Journal of Physics*, 69(S1), S54-S64
- Champagne, A. B., Gunstone, R. F., & Klopfer, L. E. (1982). A perspective on the difference between expert and novice performance on solving physics problems. *Research in Science Education*, 12, 71-77.
- Chi, M. T. H., Feltovich, P. J., & Glaser, R. (1981). Categorization and representation of physics problems by experts and novices. *Cognitive Science*, 5(2), 121-152
- Davidson Institute of Science Education, Weizmann Institute of Science, Rehovot, Israel.  
<http://davidson.weizmann.ac.il/eng/index.php>
- Everett, H.R. (1989). Survey of collision avoidance and ranging sensors for mobile robots. *Robotics and Autonomous Systems*, 5(1), 5-67.
- Halloun, I., & Hestenes, D. (1998). Interpreting VASS dimensions and profiles for physics students. *Science & Education*, 7(6), 553-577
- Hammer, D. (2000). Student resources for learning introductory physics. *American Journal of Physics*, 68, (S1), S52-S59
- Redish, E. F., Saul, J. M., & Steinberg, R. N. (1998). Student expectations in introductory physics. *American Journal of Physics*, 66(3), 212-224.
- Renkl, A., Mandl, H., & Gruber, H. (1996). Inert knowledge: Analyses and remedies. *Educational Psychologist*, 31(2), 115 – 121.
- Sherin, B. L. (2001). How students understand physics equations. *Cognition and Instruction*, 19(4), 479-541.
- S.I.T (Systematic Inventive Thinking) Ltd. (2005).  
Online: <http://www.sitsite.com/app/methodGeneral.asp>
- Tuminaro, J. (2004). A cognitive framework for analyzing and describing introductory students' use and understanding of mathematics in physics. Doctoral Dissertation  
<http://tomos.umd.edu/drum/handle/1903/1413?mode=simple>
- Yurish, S. Y. (2009). Non-contact, short distance measuring system for wide applications. XIX IMEKO World Congress Fundamental and Applied Metrology, September 6–11, 2009, Lisbon, Portugal.



## **Energy: an experiment-based route from context to concept**

Author: Paul Logman ([P.S.W.M.Logman@uva.nl](mailto:P.S.W.M.Logman@uva.nl))

Co-author: Wolter Kaper ([W.H.Kaper@uva.nl](mailto:W.H.Kaper@uva.nl))

Co-author: Ton Ellermeijer ([A.L.Ellermeijer@uva.nl](mailto:A.L.Ellermeijer@uva.nl))

University of Amsterdam

AMSTEL Institute

Science Park 904

1098 XH Amsterdam

Netherlands

### ***Abstract***

*In order for students to develop a quantitative conception of energy we propose an experiment-based context to concept learning trajectory.*

*Design engineering contexts provide opportunities to have students discover quantitative physical laws using laboratory-scale experiments. In our teaching experiment we have met two major problems to such an approach. Initially students don't see a contextual need for doing experiments nor for extracting a law from these experiments. The design engineering context offers the opportunity to ask students context-based questions to clarify these needs. To help teachers do so we have created a list of context-based responses to such problems. We have also set up a classification scheme to keep track of students' progress along our proposed learning trajectory as they overcome the major problems. Using this classification scheme we analyzed the learning process and tested three different design engineering contexts.*

*In this paper we only focus on partial laws of energy conservation. This teaching experiment is part of a larger project in which we plan to propose a fully context-based trajectory aiming at the general law of conservation of energy.*

### ***Introduction***

Curriculum innovation committees for the exact sciences in the Netherlands have chosen a context-based approach to education. A number of criteria for the use of contexts have been described by Gilbert (Gilbert, 2006) which we will be using as precisely as possible.

Goedhart (Goedhart, 2004) says contexts could obscure the concept yet Gilbert (Gilbert, 2006) says concepts seem to be taught as effectively as in more traditional approaches.

Choosing energy as our subject, being a difficult and abstract concept, should provide us with a proper test case for these findings.

Besides that, students' ideas in current secondary education on energy are diagnosed as inflexible in formal examination tasks (Borsboom et al., 2008). The same problem has earlier been observed with students attending university chemistry courses on thermodynamics (Kaper, 1997).

As the scientific method has historically proven to produce flexible concepts we try to stay as close to the practice of science as possible. For these reasons we chose an experiment- and context-based approach from which students should grasp the concept of energy.

With this in mind we posed the following main research question for our project:

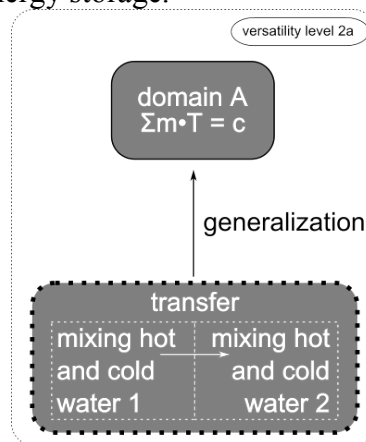
*Which characteristics and what educational approach does a successful experiment- and context-based teaching-learning sequence have which develops a versatile conception of the general law of energy conservation in secondary school students?*

In this paper we focus on reaching partial laws of energy conservation only.

## Theory and design principles

### Development of a conception of energy

Students enter secondary education with a preconception of energy that connects to the world in which they live (Watts, 1983). In a couple of years students' understanding of energy should develop towards the scientific view. Opinions on the way in which this development should be organized vary widely. Several representatives say we should stay true to the scientific view of energy from the very introduction of the concept (Peters, 1981; Warren, 1983; Swackhamer, 2005) which makes it necessary to introduce highly abstract concepts like energy densities or fields at an early stage. Swackhamer adds that the traditional educational concept of energy forms contradicts this scientific view and should therefore not be used. Staying close to the scientific view Falk (Falk et al., 1983) introduces energy carriers to describe energy transport and Lawrence (Lawrence, 2007) introduces energy stores for energy storage. In Lawrence's approach it becomes clear that energy transport is very different to energy storage as it needs to be described by transfer of energy from one store to another. We, like Warren, think the scientific view of energy may be too abstract a concept for secondary school students to attain in one go. So instead of staying perfectly true to the modern scientific *view* of energy we suggest to stay as close to the scientific *method* as possible by having students develop a conception of energy from experiments. For example within a set of similar experiments (e.g. the mixing of liquids of different temperatures) students observe a regularity. Students can then state the governing law and are able to find a pre-form of the general law of conservation of energy (e.g.  $\Sigma m \cdot T = c_1$ ) (see Figure 1). Kaper (Kaper et al., 2002a, b) has shown that energy forms are consistent and valid within limited domains and we assume that the same holds for these pre-forms of the energy conservation law. And by limiting ourselves to energy storage we, like Lawrence, make a clear distinction between energy transport and energy storage.



**Figure 1 Generalization towards a pre-form of the law of conservation of energy**

As soon as some of these pre-forms of the energy law are known to students, two additional steps are necessary to attain the concept of energy.

First we show students that in some experiments one can exchange a portion of “ $m \cdot h$ ” for a portion of “ $m \cdot T$ ” according to a certain exchange ratio. This makes it possible for students to combine the two separate pre-forms into a bigger law like  $\Sigma m \cdot g \cdot h + \Sigma m \cdot c \cdot T = c_4$  in which  $g$  and  $c$  together make up the exchange ratio between the two phenomena. This bigger law now predicts additional phenomena and covers a larger domain which can be checked by the students to build up trust in this new law.

After combining a couple of pre-forms of the energy law in this manner a pattern becomes evident. Students may now give names to the elements of the pattern: each phenomenon has a characteristic variable which together with some constants determine its portion, or, we might

say, its “energy”. These terms might then be called “forms of energy” and the sum itself “total energy” so students can reach the conclusion that “the sum of all forms of energy is constant” for a certain system.

#### *On the use of contexts*

Curriculum innovation committees for the exact sciences have chosen a context-based approach to education as it connects better to students’ interests, it enhances their motivation and it shows the relevance of newly learned concepts better (Eijkelhof et al., 2006).

Gilbert (Gilbert, 2006) describes a number of criteria for the use of contexts:

- Contexts must arise from the students themselves, from actual social issues or industrial settings and must address the zone of nearest development in students.
- The assignments need to clarify a certain way of operating and must consist of clear examples of major concepts.
- The context needs to give rise to a coherent jargon for students to use. The context decides which concepts are useful to achieve this.
- Every important subject needs to be related to background knowledge. Students need to be able to recontextualize.

The practice of either technical designers or scientists contains in certain instances the need for construction of an empirical law. Staying as close to real life experiences as possible we choose to start with design engineer practices. In the Netherlands the Techniek15+ approach has been in use for several years now (Techniek15+, 2002). It has been developed by a project group involving five Dutch universities to teach students the principles of designing so we decided to adopt this approach.

With our choice for design engineering we think we can satisfy Gilbert’s conditions because such contexts arise from an industrial setting and we can choose our specific contexts to contain clear examples of pre-forms of the energy conservation law. It is our aim that students construct some of the pre-forms of the energy law, purely driven by needs that arise from the technical context. Through this the usefulness of these laws to the context will become clear. The Techniek15+ approach has a problem orientation phase in which the context is connected to the background knowledge of the students.

By introducing contexts to grasp a concept we have to realize that we now have two different goals to reach by the students: a contextual and a conceptual goal. The contextual goal is to solve the context-based problem. The conceptual goal is to attain a pre-form of the energy conservation law.

The teaching setup explained above serves in this research to answer the following specified research question:

*Does a teaching-learning sequence, using design engineering contexts, structured according to Techniek15+ enable a versatile conception of partial laws of energy conservation in a way that motivates students?*

#### ***Design implementation***

We wanted contexts with convincing experiments and chose the following: moving a very heavy optical table, designing a thermostatic mixer tap, and designing a rollercoaster. The student’s situation (an engineering bureau), their client, and this client’s problem were sketched by the teacher. Groups of students were then to start work on solving the client’s problem (contextual goal). The whole learning process should be led only by reasons stemming from these contexts.

We structured the design process according to the six phases from the Techniek15+ program (Techniek15+, 2002; Ellermeijer et al., 2004). We used laboratory-scale experiments to test unknown factors in the design. In our choice for the context-based problems, we took care that in this phase students would need a law (e.g. to scale their conclusions from a laboratory

experiment to a real-sized problem solution) so we added a phase in which a generalization is to be made. Furthermore the contexts were chosen such that the needed law to our best estimate would be one of the pre-forms of the energy conservation law (conceptual goal). In their reports to their clients we expect students to show the relevance of the found law to their chosen solution.

Using this approach we expect students to move subsequently through the phases as mentioned in Table 1.

**Table 1 Overview of the various learning phases**

Phase	Activity
I	Problem orientation (teacher acts as client)
II	Demands analysis
III	Idea matrix
IV	Design proposal
V	Laboratory-scale experiments
VI	Generalization to a first law (needed e.g. for scaling)
VII	Final reports to clients after discussion

The generalizations we assume students will come up with from their experiments are shown in Table 2 (any equivalent formulation will be acceptable in the students' advice reports as well).

**Table 2 Contextual goals versus conceptual goals per context**

Contextual goal	Conceptual goal
Moving an optical table	$m_1 \cdot h_1 + m_2 \cdot h_2 = c_1$
Thermostatic mixer tap	$m_1 \cdot T_1 + m_2 \cdot T_2 = c_2$
Rollercoaster	$k \cdot h_1 + v_1^2 = c_3$

In our first teaching experiment the researcher taught the classes making it easy to respond to smaller and bigger problems students showed in reaching the conceptual goals. Phases I to III and phase VII did not show major issues so we will discuss these phases concisely. During the phases IV to VI in several cases the teacher/researcher had to explain why design engineers work the way they do, and we will elaborate on his responses to the students.

*Phase I-III: Problem orientation, Demands analysis & Idea matrix*

In phases I and II the teacher needs to know the context very well making him able to answer any context-related questions the students may pose. In phase III some explanation on how the idea matrix works was needed for some groups of students.

*Phase IV-V: Design proposal & Laboratory-scale experiments*

After phase III students understand the contextual problem and have imagined various possible solutions. Students however are not always aware of problems left in their solutions so we created a worksheet in which they had to write down all the things they were not sure of. Then these uncertainties were discussed in class to decide which were the major ones to address.

Even after this discussion some groups may address the minor, easier to solve problems first. To focus the students on the major problems the teacher explained that in design engineering practices there is only a limited amount of time available to come to a solution and that in this solution the client needs an answer to the major problems most.

Next we expect the students to test their solutions to the major problems experimentally but students (a) may not be used to this or (b) trust others to have done the testing for them (when using established techniques in their solution). The teacher's response to (a) was to compare the context to other contexts in which the need for experiments is clear (e.g. the problem with

sealing the oil well in the Gulf of Mexico). In the case of trusting ready-made solutions (b) the teacher tried several responses but we have not found a satisfying response yet.

At this point students should design their experiments. Some students have trouble doing so and the teacher helped in this process by suggesting to make drawings and build laboratory-scale models of their solutions as design engineers do.

An overview of the issues for phase IV-V and the respective responses of the teacher can be found in Table 3 which shows we do not yet have an effective response to the issue of trusting established techniques.

**Table 3 Issues and our responses in phase IV-V: scale experiments**

<b>Issue</b>	<b>Response</b>
Focus on minor problems	<ul style="list-style-type: none"> <li>- Design engineers address major problems first</li> <li>- Add worksheet in which students have to write down questions and insecurities</li> <li>- Classroom discussion of encountered problems</li> </ul>
Not used to testing ideas with experiments	<ul style="list-style-type: none"> <li>- Teach to do so by testing ideas with experiments</li> <li>- Compare context to other contexts in which a solution is as yet unknown</li> </ul>
Trusting established techniques	<ul style="list-style-type: none"> <li>- no effective response yet</li> </ul>
Designing experiment	<ul style="list-style-type: none"> <li>- Think of a laboratory-scale version</li> </ul>

#### *Phase VI: Generalization*

Untrained students have a hard time generalizing a useful law from experiments. Their problems stem from three successive stages: pinpointing relevant variables, recognizing that a law would be useful and finally constructing such a law.

To pinpoint relevant variables students were helped by being asked which variables would be relevant in the real situation instead of in the experiment (e.g. “what would the movers be interested in?”, students:”of course the weight that can be lifted and how high it can go”).

Some students do not recognize that a law would be useful but instead insist on measuring the real situation in a similar way. To address this the teacher explained that it would not be very practical if things went wrong in the real-size try-out. Designers need to be able to say that there’s a fair chance of things going right after doing laboratory-scale experiments.

Last but not least we expect students to have a hard time constructing a possible relationship between the relevant variables. We noticed however that during the experiments as we asked about the workings of the various apparatus students started to make generalizations by themselves in describing the workings. For instance, it became clear that one could make it very easy to lift a heavy object by some apparatus but then one would have to cover such long distances that it would take very long to hoist it up or down one floor.

In Table 4 we have made an overview of all the issues for this phase and our corresponding responses.

**Table 4 Issues and our responses in phase VI: generalization**

<b>Issue</b>	<b>Response</b>
Pinpointing relevant variables	<ul style="list-style-type: none"> <li>- Compare experiment to real situation</li> <li>- Help measuring difficult variables</li> </ul>
No need for generalization	<ul style="list-style-type: none"> <li>- A real-size tryout could be disastrous</li> <li>- There’s a need for a fair chance in succeeding in one go</li> </ul>
Find relationships between relevant variables	<ul style="list-style-type: none"> <li>- Ask about the workings of the chosen</li> </ul>

*Phase VII: Final reports*

In Phase VII we did not find major issues. Help by the teacher was only needed in structuring the advice report.

**Research method**

The teaching-learning sequence has been tested in a first experiment with a class of seventeen 16-year-olds from the researcher’s school. It replaces the regular quantitative introduction of the concept of energy.

In this phase of our research we want to find out whether our learning process is possible for students to follow so we want to identify which are the most difficult phases in this process and what are the laws students come up with during the learning process. To identify these difficulties and laws we recorded the lessons on video and made audio recordings of both the teacher helping the students through this process and one group of average students in particular. To stimulate discussion and thereby enhancing our measurements students worked in groups. Based on our findings we created a classification scheme which we subsequently used to analyze the groups’ progress with. To find evidence that the groups saw their construction of a pre-form of the law of energy conservation as relevant to the various contexts their advice reports were used.

The classification scheme we came up with shows the student’s progress along the most problematic phases (see Table 5). Phases I-III are combined into level 1, phases IV-V in level 2, phase VI can be compared to level 3, and level 4 shows the relevant use of the new found law in an advice report (phase VII).

**Table 5 Classification scheme for a context-concept learning process**

Learning process level	Description
0	Student is not interested in the assignment or does not know what to do.
1	Student shows signs of interest or knowing what to do.
2	Student uses the word scaling and starts experimenting.
3	Student uses a law to describe results or in their advice report.
4	Student uses a law derived consistently from their experiment to explain choices in their solution to the context-based problem.

Once we have established evidence that a student has attained a certain level we assume that this student also has command of every lower level or has overcome any earlier problems in attaining those levels.

**Results**

In the end all groups came up with laboratory-scale experiments (level 2) even though some were still trusting established techniques. Because trusting ready-made solutions is a logical thing to do when they are available in the context this shows such contexts need redesigning. We were able to classify our groups into the various levels of our scheme according to statements they made. Examples of student’s statements are shown in Table 6.

**Table 6 Examples of student’s statements showing levels 1 to 3**

Learning process level	Student’s statement
1	“I’m not sure whether such a hydraulic lift can cope with that.”
2	“So in theory it’s this and then in practice you are not sure. Yes, we can test whether that is strong enough.”
3	“So 150 grams, 80 grams. That’s half !”

In Table 7 we give examples of consistent laws students came up with in their advice reports and which we used as showing evidence of attaining level 4.

**Table 7 Examples of consistent laws per context**

Context	Relationship between variables
Moving an optical table	$p = F/A$ and $A = F/p$ to describe a hydraulic elevator
Thermostatic mixer tap	$V_c = V_w : (T_{end} - T_c) \times (T_w - T_{end})$
Rollercoaster	$v = \sqrt{(6,3h)}$

Because of our open design students came up with more diverse experiments than expected. Where beforehand the researchers had come up with two possible experiments the students came up with four, only one of which was thought of by the researchers. However the new experiments did not pose a problem as through the context they quite naturally led to the same law as intended.

Using our classification scheme it's not difficult to find positive evidence for attaining a certain level. Negative evidence could only be found for level 4 if students used a non-relevant law or a law that was not consistent with their experimental data in their advice report.

Analyzing the advice reports and the video and audio recordings to ascribe the various levels to the various groups we attained the following results for the first context of moving a heavy optical table (see Table 8).

**Table 8 Attained levels for the first context**

**(- indicates evidence of not achieving corresponding level; + indicates positive evidence of achieving corresponding level; in between brackets the lesson in which the evidence was found)**

	Group 1	Group 2	Group 3	Group 4	Group 5	Group 6	Group 7	Group 8
Level 0								
Level 1	+(1)	+(1)	+(1)	+(1)	+(1)	+(1)	+(1)	+(2)
Level 2		+(4)	+(4)	+(6)	+(4)	+(4)	+(6)	+(5)
Level 3	+(6)	+(6)		-	+(5)		+(6)	-
Level 4			+(6)	-	+(6)	+(6)		-

All groups at least showed evidence of attaining level 1 and 2 for this context (group 1 did their experiment at unrecorded hours). From the recordings we gathered that 6 out of the 8 groups did generate a useful law from their experiment (groups 3 and 6 used it in their advice report). We cannot be sure about the groups that did not use this law consistently in their advice report whether they saw the relevance of the law to their solution or not. Only 3 groups did use their new found law in their advice report to explain their solution of the context-based problem (level 4). All groups seem to follow our planned phasing of the learning process.

For all contexts we analyzed the advice reports to determine whether groups reached level 4 (see Table 9).

**Table 9 Attainment of level 4 for the various groups in the various contexts**

	Group 1	Group 2	Group 3	Group 4	Group 5	Group 6	Group 7	Group 8
context I			+	-	+	+		-
context II	+			+		+	+	+
context III	+				+	+		+

In the audio recordings of the first context (moving a very heavy optical table) students of groups 1, 2, and 7 talked about possibly useful laws and so may have achieved level 4 as well

but they did not show the relevance of the law in their advice reports. Groups 4 and 8 used non-relevant laws in their advice report to the first context. In the second and third context we didn't find any use of a non-relevant law in the advice reports anymore. We did find however that while groups 4 and 8 had used a non-relevant law in the first context they now used a relevant law in the new contexts and therefore may have attained level 4 during the series of lessons. A further analysis of the audio and video recordings should bring more conclusive results on the groups for which we had to remain undecided.

### ***Conclusion***

Design engineer contexts which have the need for simulations on laboratory-scale seem to be able to provide motives for students to generalize their experiments into a relationship between variables. The contextual need for this may be revealed by asking the right context-based questions. By choosing the context appropriately the generalization constructed by the students can be a pre-form of the energy conservation law.

Using contexts like these in a first try-out we have found that designing an experiment and extracting a law from such an experiment is difficult for students but not impossible. The two main difficulties were that initially students don't see a contextual need for doing experiments nor for extracting a law from these experiments. Most students can be motivated to overcome these difficulties by asking the right context-based questions. Students can be motivated to formulate a law by pointing out the need for upsizing the results of their laboratory-scale experiments. In this way they become versatile in using the law (they predict a situation that was different from the one in the experiment), as well as they appreciate the need for such versatility. The issue of students trusting established techniques could not be resolved within the context, at least for the context of moving the heavy optical table. Our current estimate is that we should redesign this context.

Based on the above mentioned critical phases we have created a classification scheme for such a context to concept learning process. By using this scheme on our first try-out we can conclude that 3 out of the 8 groups monitored have realized the trajectory as planned. On the other groups no conclusive evidence can be given without further analysis. Our analysis of the students' progress on the first 4 levels shows that every group has attained level 4 for at least one of the design engineer contexts chosen which makes us confident that these contexts are suitable to achieve an experiment-based route from context to concept for energy and possibly for other concepts as well.

### ***Discussion***

Limiting ourselves to advice reports of all groups and video recordings and audio recordings of the teacher and only one group there will always be groups of students we haven't monitored at essential phases and we therefore have to be undecided on whether they made a certain step in the learning process or not. Our use of groups of students of course diminishes our view on what individual students are capable of. In future cycles we will be testing students individually in the end and give them an individual questionnaire as well.

There are many routes to lead students to understand the concept of energy besides the traditional teaching (Herrmann, 1989; Swackhamer, 2005; Lawrence, 2007). We think our proposed strategy may be an interesting addition to these strategies as it may be both convincing, motivating and showing the usefulness of the concept of energy by means of its empirical and contextual base.

### ***References***

Borsboom, J., Kaper, W.H., et al. (2008). The Relation between context and concept in case of forming an energy concept. GIREP. Cyprus.



- Eijkelfhof, H., Mulder, G., et al. (2006). *Natuurkunde leeft. Visie op natuurkunde in havo en vwo*. Amsterdam: Nederlandse Natuurkundige Vereniging.
- Ellermeijer, A.L. & Beurs, C.d. (2004). Technology Enhanced Physics Education. GIREP Conference 2004: Teaching and Learning Physics in new Contexts. E. Mechlová. University of Ostrava, Ostrava: 11–16.
- Falk, G., Herrmann, F., et al. (1983). Energy forms or energy carriers? *American Journal of Physics* **51**(12): 1074-1077.
- Gilbert, J.K. (2006). On the Nature of “Context” in Chemical Education. *International Journal of Science Education* **28**(9): 957 - 976.
- Goedhart, M. (2004). Contexten en concepten: een nadere analyse. *NVOX : tijdschrift voor natuurwetenschap op school* **29**(4): 186-190.
- Herrmann, F. (1989). Energy density and stress: A new approach to teaching electromagnetism. *American Journal of Physics* **57**(8): 707-714.
- Kaper, W.H. (1997). *Thermodynamica leren onderwijzen*.
- Kaper, W.H. & Goedhart, M.J. (2002a). 'Forms of Energy', an intermediary language on the road to thermodynamics? Part I. *International Journal of Science Education* **24**(1): 81 - 95.
- Kaper, W.H. & Goedhart, M.J. (2002b). 'Forms of energy', an intermediary language on the road to thermodynamics? Part II. *International Journal of Science Education* **24**(2): 119 - 137.
- Lawrence, I. (2007). Teaching energy: thoughts from the SPT11&ndash;14 project. *Physics Education* **42**(4): 402-409.
- Peters, P.C. (1981). Where is the energy stored in a gravitational field? *American Journal of Physics* **49**(6): 564-569.
- Swackhamer, G. (2005). Cognitive resources for understanding Energy. *Arizona State University*.
- Techniek15+ (2002). "Techniek 15+." Retrieved August 12th, 2010, from <http://www.techniek15plus.nl/>.
- Warren, J.W. (1983). Energy and its carriers: a critical analysis. *Physics Education* **18**(5): 209.
- Watts, D.M. (1983). Some alternative views of energy. *Physics Education* **18**(5): 213-217.

## Collecting, organizing, representing and interpreting values of measurement in elementary school

Valérie MUNIER, H  l  ne MERLE and Danie BREHELIN

LIRDEF, EA 3749, Universit   Montpellier 2, IUFM, 2 place M. Godechot, BP 4152, 34 092 Montpellier cedex 5, France

[valerie.munier@montpellier.iufm.fr](mailto:valerie.munier@montpellier.iufm.fr)

### Introduction

Our research team carries out research about mathematics and physics interrelations as recommended by official instructions: *"Mathematics on one side, experimental sciences and technology on the other, must be linked together as often as possible in the implementation of curricula"* (Minist  re de l'Education Nationale, France, 2007). Strong insistence on the need to associate mathematics and science is not limited to France, and these interrelations are recommended particularly through the measurement of quantities, in France as in other countries, as the United States for example: *"Measurement helps connect ideas within areas of mathematics and between mathematics and other disciplines"* (NCTM, 2000).

The concept of measurement is fundamental in science. In order to be meaningful, the value of a measurement must be given with a certain level of uncertainty. As for science in general, the concepts of quantities and measurement are fundamental in science education. In France, official instructions for elementary school argue for students to carry out activities of measurement, followed by treatments and analysis of the data obtained during these activities (MEN, 2008). Pupils must *"learn gradually to sort out data, to classify them, to read or to produce tables, graphs and to analyze them"*. The notion of measurement "uncertainty" appears in 4<sup>th</sup> and 5<sup>th</sup> grades. A similar approach is proposed in other countries, for example *"Students in grades 3-5 should encounter the notion that measurements in the real world are approximate..."* (NCTM, 2000).

In the area of physics teaching, many studies deal with measuring, data collection, and measurement uncertainty. Among these, a few rare studies have dealt with elementary school (for example Petrosino & al., 2003), but most of the research on students' difficulties about measurement uncertainty concerns older pupils from middle school to university (Lubben & Millar (1996), S  r   & al. (1993), Evangelinos & al. (2002), Lippmann (2005), Maisch & al. (2008), Volkwyn & al. (2008)). These researches show difficulties about measurement, for young pupils as well as for university students. For example Petrosino et al (2003) state that *"Students are given few, if any, conceptual tools to reason about measurement variability"*.

In this paper, we try to identify and to develop the reasoning of young French pupils on measurement variability. Our research questions are the following:

- Are they the pupils to elaborate and interpret frequency table and bar graph to represent the results of several measures of the same quantity?
- Can they acquire the notions of mode and confidence interval?

### Methodology

We present a teaching sequence divided into two parts: the first part included seven one-hour sessions in grade 4, the second part three sessions in grade 5, the following year, with the same students. There were 24 pupils for the first sequence and 22 for the second. The class had an average academic standing. The teachers conducted the experimental teaching sequences themselves, which we had prepared in detail and sat in on as observers.

To evaluate these teaching sequences, our main sources of data were field notes, videotapes, as well as the intermediate written traces produced and individual written tests given each year. We also administered clinical interviews.

We chose for these sequences to confront pupils with a large number of measures of the same quantity, every pupil making his(her) own measure before comparing it to that of the others. Furthermore the pupils had to elaborate by themselves techniques of presentation and analysis of these results. The two sequences are briefly described below.

### Teaching sequences

1<sup>st</sup> sequence (grade 4): How to measure the "diameter" of a cylinder?

The first two sessions aim at making the pupils elaborate a relevant but not very reliable measuring instrument (a calliper) to make sure of an important variability of the results. During the two following sessions the pupils have to present and interpret the results of several measures of the same quantity realized with this rudimentary instrument. The aim of session 5 is to work on the properties of measuring instruments by comparing the measures obtained with a more reliable instrument. In sessions 6 and 7, pupils must compare the values of measurement obtained with two different methods in order to show that the variability depends on the protocol. We will not develop these two points in this paper.

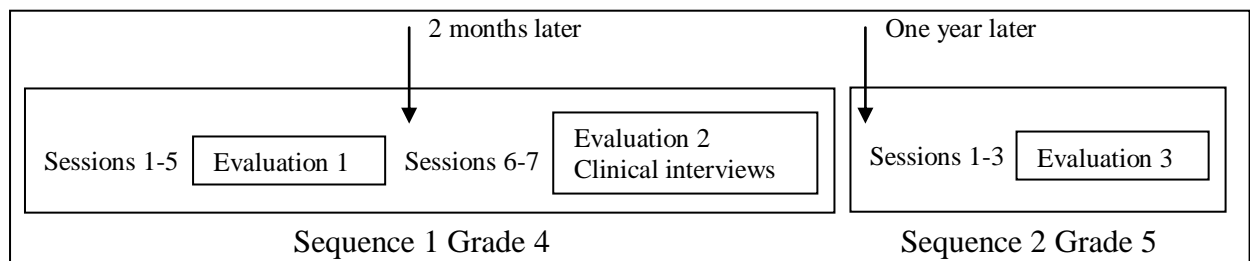
The two last sessions took place two months after the first five to see if the pupils were able to mobilize their knowledge.

2<sup>nd</sup> sequence (grade 5): How to differentiate two liquids by virtue of their density?

In this second sequence, pupils have to measure a new quantity: mass. We chose to give to the pupils digital scales, accurate to one gram, to make sure of some variability.

Pupils have two bottles, one filled with fresh water and the other one with sea water. They must identify, among these 2 bottles, the bottle which contains the fresh water, without drinking, smelling nor touching it, as they must weigh the same volume of the two bottles and compare these values with the mass of the same volume of fresh water.

In the first session pupils begin by each weighing 100 ml of water, then they have to represent and analyze these values of measurement. One aim of this first sequence is to evaluate the pupils one year later. During the two following sessions each pupil measures individually the mass of 100 ml of each of the liquids, then they have to use these measures to determine which bottle contains fresh water.



### Results

The results will be presented according to two aspects: organization and representation of data, choice of the result to be noted (notion of confidence interval). For each of these items we will present, every time possible, the evolution of the pupils' performances during the sequences.

#### *Organizing and representing values of measurement*

At the beginning of the session 3, each pupil has measured the same quantity and each pupil has the list of the results from the entire class. They had to find how to « present these results



solution but note that we do not know how many found every value. One pupil proposes to put a column above the values, bigger if many pupils have found this value than if there are not many. Finally one pupil proposes to do 1 cm for every child. After this discussion every pupil succeeds in realizing the corresponding bar graph.

During the sessions 6 and 7 two months later as well as next year, the pupils again had to represent the data of the whole class (N measures of the same quantity) to make them easier to interpret.

<i>Number of pupils spontaneously</i>	Before teaching	Session 6	2nd year
<i>taking into account the frequency</i>	14/24	17/20	19/22
<i>mobilizing the bar graph</i>	/	9/20	4/22

Before teaching, 14/24 take into account the frequency; that number grows to 17/20 two month later and to 19/22 one year later. The frequency table became a tool which they mobilize spontaneously. On the other hand, the pupils mobilize less spontaneously the bar graph than the frequency table.

Even if they do not use it spontaneously, the pupils understood well this mode of representation and they know how to pass from a mode of expression to the other. Indeed, in the first evaluation all pupils succeed in completing a frequency table from a diagram and 21 out of 23 succeed in completing a diagram from a frequency table. It is thus a mode of representation of the data build by the pupils and acquired by the quasi-totality of them. However the analysis of the errors shows an important difficulty when pupils draw bar graphs:



Among the pupils who produce them spontaneously, many write down only the values who were found. The interest to note all the values must be repeatedly discussed with the whole class during sequences.

At the end of the sequences, an exercise proposed over the two years (evaluations 2 and 3) shows that, after teaching, a large majority of pupils understood the interest to indicate the values of frequency zero on the bar graph.

### **Interpreting values of measurement**

We wanted to know if the pupils chose, to communicate a result, to give a single value (their value of measurement, the mode?) or an interval when they had the list of the measures from the whole class. We voluntarily chose a very opened formulation: " *What result are you going to note on the exercise book or to communicate to another pupil?* ".

During the first individual work (session 3), two thirds of pupils chose the most frequent value, 5 pupils took into account only their measure and one pupil spontaneously proposed an interval.

During the following collective discussion, the teacher uses the bar graph on the board to steer the pupils from the most frequent value towards the notion of interval. Pupils continue to focus on the value found by most of them *"It is 125 because it is the most found result"*, but the idea of interval appears: *"Maybe it is not 125 ..."*, *"The result is between 124 and 126, we cannot know the "good" result exactly"*.

Pupils' answers to the question " What result are you going to note on the exercise book or to communicate to another pupil? " show a very important evolution during the sequences.

	mode	interval
Before teaching	16/24	1/24
After the 1st sequence	8/24	11/24
One year later	19/22	3/22
After the 2nd sequence	3/13	10/13

Before teaching 16/24 give the mode and 1 gives an interval, and after the sequences, 10/13 give an interval. First of all, these results show that the pupils easily appropriate the notion of mode. The results at the beginning of the second year show that it is necessary to work regularly, several times, to fight against the tendency to supply "a" value, the "good" value and lead pupils to the idea that an interval gives more information. However, after teaching, a large majority of pupils are able to supply an interval.

*Result to note – Notion of confidence interval*

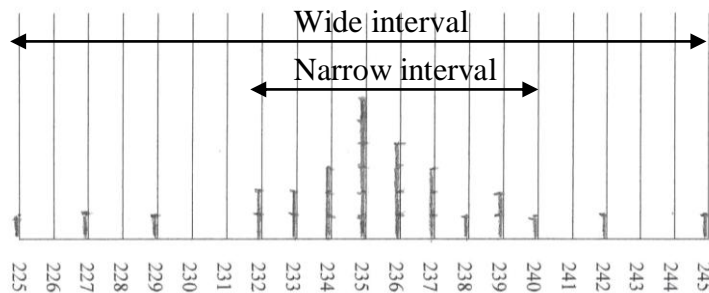
At the end of the first sequence the clinical interviews allow to see if pupils are able to argue in terms of confidence interval. Pupils are questioned by groups of 3 to 4 pupils to facilitate discussions between them. They have a bar graph representing measures of the whole class. They have to discuss the following question ' If you had to give to an absent pupil the « perimeter » of the cylinder, what would you tell to him(her)? '.

In most of the groups there are discussions about the reliable level we can have for the result according to the width of the interval, for example:

Groupe 1	Groupe 2
<ul style="list-style-type: none"> <li>- Kader: <i>The answer is 16</i></li> <li>- Maelly: <i>about 16 but not necessarily 16</i></li> <li>- Juliette: <i>Between 15 and 16</i></li> <li>- Kader: <i>Between 15 and 17</i></li> <li>- Maelly: <i>Between 15.5 and 16.5</i></li> <li>- Teacher: <i>If we say between 15 and 17 or if we say between 15,5 and 16,5, are we more or less sure?</i></li> <li>- Kader: <i>Between 15 and 17 it is better. We are sure that it is between.</i></li> </ul>	<ul style="list-style-type: none"> <li>- Marie A: <i>Between 15.5 and 16.5</i></li> <li>- Francis: <i>Because between both values, there are more persons who found results.</i></li> <li>- Elyas: <i>Between 15 and 16</i></li> <li>- Teacher: <i>The pupils of the 1st group said between 15 and 17. Why in your opinion?</i></li> <li>- Francis: <i>Naturally, it is better between 15 and 17 because there is everybody ... we are sure that it is between 15 and 17, but it is more precise to say between 15,5 and 16,5.</i></li> </ul>

These interviews realized at the end of first sequence show that from the first year discussions took place between pupils on the necessity of a compromise between precision and certainty. Pupils began to understand that the more we choose a narrow interval the more precise we are, but more we risk to make a mistake.

To test pupils' ability to argue individually in terms of confidence interval we proposed the same exercise in the second and third evaluations. In this exercise pupils have the following bar graph representing the results of measure of a length by all the pupils of a class.



They have to analyse two propositions of answers given in the form of interval, a wide interval, including all the values of measurement, and a narrow interval. They have to choose a confidence level for each of these intervals:

If I choose between 232 and 240 (respectively between 225 and 245)

- 1- I am sure to have the good value
- 2- I am almost sure to have the good value
- 3- I am not sure to have the good value

They also have to indicate which result they would give and justify their answer.

7/21 (1<sup>st</sup> year) and 6/13 (2<sup>nd</sup> year) indicate that we are " more sure " if the interval is wider. This shows that they reached, in a qualitative way, the notion of confidence interval.

Moreover when they choose an interval, their arguments are consistent. Those who choose a very wide interval make it "to be sure", so favouring " security ".

For example, one pupil is not sure with the narrow interval and sure with the wide interval, and he chooses as interval 225-245 "to be sure": he understood that our confidence rate is linked to the width of the interval and chooses the "security" to give its result.

Pupils who choose the narrow interval privilege the "precision" and/or argue on the large number of results in this interval. For example, Constance is almost sure with the narrow interval and sure with the wide interval, and chooses as interval 232-240 " because many persons found between these two values ". She so gives greater importance to precision while being aware of a certain "risk".

In both cases the justifications show that these pupils begin to appropriate the notion of confidence interval.

### Conclusion

Concerning organization and interpretation of the data, we notice that at the end of the sequences most of the pupils were able to build a frequency table and a bar graph from a list of N measures of the same quantity. When they interpreted such a graph most pupils took into account the measures of the whole class, either by giving the mode or by giving an interval. Finally some of them were able to argue in terms of confidence interval, by making use of a correct qualitative statistical reasoning.

## References

- Evangelinos D., Psillos D. & Valassiades O. (2002). An Investigation of Teaching and Learning about Measurement Data and their Treatment in the Introductory Physics Laboratory. In D. Psillos and H. Niederer (Eds.), *Teaching and Learning in the Science Laboratory* (pp. 179-190).
- Lippmann, R. (2005). Teaching the concepts of measurement: an example of a concept-based laboratory course, *Am. J. Physics*, 73(8), 771-777.
- Lubben F. & Millar R (1996). Children's ideas about the reliability of experimental data. *IJSE*, 18(8), 955-968.
- Maisch C., Ney M. & Balacheff N. (2008) Quelle est l'influence du contexte sur les raisonnements d'étudiants sur la mesure en physique ?. *ASTER*, 47, 43-70.
- Ministère de l'Éducation Nationale (France). (2007). Programmes d'enseignement de l'école primaire, Bulletin officiel de l'éducation nationale, hors série n°5, April 12.
- Ministère de l'Éducation Nationale (France). (2008). Programmes d'enseignement de l'école primaire, Bulletin officiel de l'éducation nationale, hors série n°3, June 19.
- NCTM. (2000). *Principles and Standards for School Mathematics*. Reston, VA: National Council of Teachers of Mathematics.
- Petrosino A J., Lehrer R. & Schauble L. (2003). Structuring Error and Experimental Variation as Distribution in the Fourth Grade. *Mathematical Thinking and Learning*. 5(2&3), 131–156.
- Séré M.G., Journeaux R. & Larcher C. (1993). Learning the statistical analysis of measurement errors. *IJSE*, 15(4), 427-438.
- Volkwyn T.S., Allie S., Buffler A. & Lubben A. (2008). Impact of a conventional introductory laboratory course on the understanding of measurement. *Physical Review Special Topics Physics Education Research*, 4, 1-10.



## Development of Physics Demonstrations in Nagoya University

Jun-ichiro Yasuda<sup>\*</sup>, Yuichi Miura<sup>†</sup>, Katsumi Senyo<sup>‡</sup>, and Masahiro Mori

<sup>\*</sup>*Center for Studies of Higher Education, Nagoya University, Nagoya, 464-8601, Japan.*

<sup>†</sup>*Graduate School of Science, Nagoya University*

<sup>‡</sup>*Institute for Liberal Arts and Sciences, Nagoya University*

<sup>§</sup>*Graduate School of Information Science, Nagoya University*

**Abstract.** The method of physics demonstrations is one of the traditional methods, usually in order for students to connect demonstrated phenomena with the related physics theory. In this work, we developed a handbook to share the knowledge of physics demonstrations among the faculty members in Nagoya U. In the handbook, we described characteristics of distinguished demonstrations and effective teaching methods with demonstrations as knowledge of physics demonstrations. We also described several examples of masterpieces of physics demonstrations and our original ones. We will explain the process of development and contents of the handbook.

### INTRODUCTION

The method of physics demonstrations is one of the traditional methods in physics classes, which has continued from the middle ages [1]. Demonstration experiments are usually conducted by a teacher in a lecture room among the explanation of a physics theory. Seeing and thinking about the physics demonstrations, the students have an opportunity to connect the demonstrated phenomena with the related physics theory and to recognize the physics theory as reality. Demonstration experiments are discriminated from laboratory experiments. Namely, laboratory experiments are usually conducted by the students in the laboratory along the textbook of the experiments [2].

In Japan, a lot of physics teachers show demonstrations in their classes [3-7], including us, some of the faculty members of Nagoya University [8]. However, as well as the other universities in Japan, each of us has *solely* developed them. Therefore, the knowledge and methods of physics demonstrations have not been shared among us. This causes redundant efforts to spend a lot of time to produce apparatuses of demonstrations and a lot of trials to find the effective teaching methods. It is desirable that there is a facility to stock the apparatuses of demonstrations in the university, or a handbook and/or a webpage which describe the effective teaching methods of demonstrations (for example, [9,10]). With these equipments, we can save a lot of time to prepare the demonstrations, and can improve the higher-quality demonstrations on the existing demonstrations. In order to go through these measures and resolve the problems, we think that the *organized* support is needed.

Our project is organized with the faculty members of physics in various departments and the Center for the Studies of Higher Education (CSHE) in Nagoya U. Since the CSHE has the experience to develop handbooks on higher education [11], we have determined to develop a handbook as a tool to share the knowledge of demonstrations. A handbook has the advantages to be kept in desk easily and to be updated easily than a book, and also to be appealing if it is distributed to teachers.

In the following sections, we would like to explain the process of development and contents of the handbook.

## OBJECTIVES & METHOD OF OUR DEVELOPMENT

The objective of our project is to develop a handbook on physics demonstrations to share the knowledge among faculty members in Nagoya U. We have set the three main lines to develop the handbook. First, we have accumulated the knowledge about physics demonstrations in and out of Nagoya U. We have visited the physics classes where demonstrations are shown and have interviewed the teachers on their procedure of the demonstrations. Then, most importantly, we have developed some dozens of physics demonstrations by ourselves and have discussed what to improve and how to use the demonstrations. In addition to those in Nagoya U., we researched English and Japanese literatures on physics demonstrations more than fifteen issues, and also we held a seminar about physics demonstrations by an invited speaker [12].

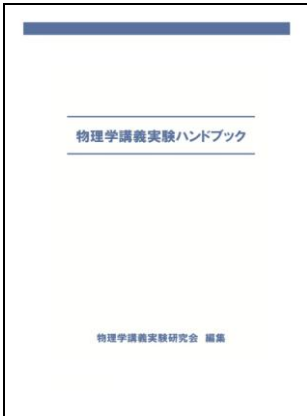
Second, we have edited the accumulated knowledge to match the needs of the students and teachers *in Nagoya U.* For example, for the students, we have described the demonstrations on the physics concepts which we think are hard to be understood for the students in our classes. For the teachers, we described how and where to get the materials and the appropriate support in order to produce apparatuses of demonstrations. In this way, we have set definite targets for editing the handbook.

Third, we focused on the demonstrations of the Mechanics and the Electromagnetism, because these two courses are the general subjects among the physics courses and are included in the curriculums of the several departments. Moreover, the phenomena of the Mechanics and the Electromagnetism are comparatively easy to be demonstrated with the materials which often appear in daily life. This is another reason of this line.

## CONTENTS OF THE HANDBOOK

We published the handbook in March 2010 and distributed them to the faculty members in Nagoya U. We have summarized the contents of the handbook in TABLE 1. In the following sections, we explain the each content in order.

**TABLE 1.** The cover and the contents of the handbook.

 <p>(A4size, 58pages)</p>	<p><b>1. Know-how of Physics Demonstrations</b></p> <ul style="list-style-type: none"> <li>- Characteristics of distinguished demonstrations</li> <li>- Effective teaching methods with demonstrations</li> </ul>
	<p><b>2. Examples of Physics Demonstrations</b></p> <ul style="list-style-type: none"> <li>- Net 15 demonstrations of our original experiments and the masterpiece experiments</li> </ul>
	<p><b>3. Useful Information for Starters</b></p> <ul style="list-style-type: none"> <li>- How and where to get the materials to produce the apparatuses etc. (some local information)</li> </ul>
	<p><b>+ Columns on physics demonstrations (E.g. success and failure stories)</b></p>

## Know-how of Physics Demonstrations

### *Characteristics of Distinguished Demonstrations*

In the first section of the know-how of physics demonstrations, we have described *characteristics of the distinguished demonstrations*. By “characteristics,” we mean the characteristics which belong to the apparatus of a demonstration. We propose the following three statements about the characteristics, where we have referred the literature by Ehrlich [13].

At first, we propose that the distinguished demonstrations are *intellectually stimulant*. For example, if the result of a demonstration is unexpected for students, they are urged to change their physical concept of the phenomenon. Or, if a demonstration is associated with daily life, the information of the phenomenon is probably connected to the students’ memory. We described the other eight examples about this statement.

Second, we propose that the distinguished demonstrations are *simple*. This means not only the apparatus of the demonstration is structurally simple, but also the result of the demonstration is visually and aurally clear. If the apparatus of the demonstration is structurally simple, it is easily to produce, repair, and improve. And if the result of the demonstration is visually and aurally clear, that is, if there are few noise of information in the demonstration, the students easily understand the phenomenon. We described the other eight examples about this statement.

Third, we propose the distinguished demonstrations are *correct*. For example, the demonstrations should be surely successful. This is because if a demonstration is failed and the teacher repeat the demonstration until it is successful, the students will confuse which phenomenon is right as a rule of physics. In another example, it is given that the experiments should be confirmed by other teachers. We will explain what this example means in detail later. We described the other two examples about this statement.

### *Effective Teaching Methods with Demonstrations*

In the second section of the know-how of physics demonstrations, we described *the effective teaching method with the demonstrations*. Even though we use the apparatus of a distinguished demonstration, we cannot necessarily teach effectively. There are several methods which we should use to teach effectively with demonstrations.

At first, we propose to *set the goal of demonstration*. Since there are several kinds of the characteristics and the goals of demonstrations, we should match them in order to teach effectively. As the examples of the goals, we picked: helping the students to understand an abstract physics theory by showing the related phenomena, testing the physics misconception of the students, or attracting student’s attention, interest, and motivation on physics. We described the other two examples of the goals in the handbook.

Second, we propose to increase the opportunity for the students to think about the demonstration. This statement is based on a common tenet that *students will fail to learn from an event when exposed to it only once* [14]. For example, we can increase the opportunity for the students to think by having the students predict the results of the demonstration or discuss the results of the demonstration with the teacher or among the students. We described the other three examples about this statement.

Third, we propose to help students to understand the demonstrated phenomenon. One of the methods is having the students concentrate on the demonstration by explaining the point to be

paid attention before showing the demonstration. Another method is building the connections between the demonstration and the knowledge which the students already have by giving the explanations associated with daily life. We have found only these two examples about this statement, and are looking for the other examples.

### **Examples of Physics Demonstrations**

In the second chapter, we described the examples of physics demonstrations. There are net fifteen demonstrations which include the ones we developed originally and also masterpieces of demonstrations. For example of a masterpiece demonstration, we picked the *Gauss accelerator* which aims to show the exchange of magnetic potential energy and kinetic energy [15]. For example of an original demonstration, we picked *Rolling Down a Hill* which aims to teach the moment of inertia. Although there are several demonstrations similar to our demonstration, we developed the apparatus and the order to show the demonstration by ourselves.

### **The Others**

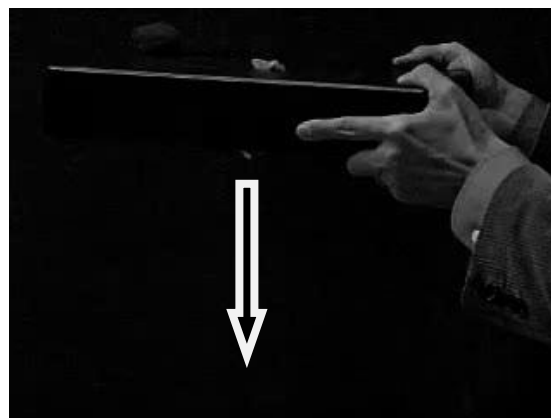
In the third chapter, we described the useful information for the starters on demonstrations. For example, we described how to order the materials of demonstrations near Nagoya U. and also where to consult a technician in Nagoya U. on designing and producing the apparatuses of demonstrations. This information is especially useful for the faculty members of theoretical physics who are not used to order such materials.

In addition to the main chapters, we described columns on physics demonstrations especially on the failure stories. As an example of the failure story, we want to pick the experiment of *Feather Drop*. This is a simple experiment that if we drop a hard book with a feather on it, the book and the feather fall down at the same speed. To this phenomenon, a teacher might give following explanation: "We can neglect the air resistance from the bellow to the feather because it is on the book. Therefore, this phenomenon means that when an object falls down freely in the gravity acceleration, the speed of the object is independent of its mass." Although this explanation seems to be right at first sight, there is an oversight in the explanation. When the book falls down, the air pressure above the book is reduced. So, there is an effect to pull down the feather downward. Namely, the feather doesn't fall freely, but falls with the acceleration by the effect of the downward force! This fact can be confirmed by pulling down the book with the acceleration more than the gravity acceleration (See FIGURE 1,2.). If the feather fell down freely, the feather would delay to the book. However, actually it doesn't.

This is a demonstration which appears in a famous book of demonstrations. Although it gives wrong explanation, there are some teachers who are not aware of it. Actually, I (Yasuda) have made the same mistake! When I showed this demonstration to the other teacher, my mistake was corrected. Through this experience, we think the demonstrations should be confirmed by other teachers, as we proposed in the third statement of the characteristics of the distinguished demonstrations.



**FIGURE 1.** Experiment of *Feather Drop*. We use a feather, a hard book, and an object whose motion can be compared to the motion of the feather. In this case, we use an *Otedama*, which is a traditional toy in Japan.



**FIGURE 2.** We can show that the feather on the book doesn't fall down freely but is accelerated by the air pressure by pulling down the book with the acceleration more than the gravity acceleration.

### SUMMARY & FUTURE WORK

In this work, we developed a handbook of physics demonstrations to share among the faculty members in Nagoya U. In the handbook, we described the characteristics of the distinguished demonstrations and the effective teaching methods with the demonstrations. We also described several examples of physics demonstrations of masterpieces and our original demonstrations.

Our work has the following significance. At first, in Japan, the faculty members in universities have not so often develop physics demonstrations *collaboratively*, let alone have paid attention to the effective teaching methods with the demonstrations. We accomplished these works from the dual-views, namely, from the physics researchers' view and from the higher education researchers' view.

As future works, we have plans to improve our works quantitatively and qualitatively. In order to improve our work quantitatively, we will build a webpage to share the knowledge of demonstrations. With the webpage, we can update the contents easily, can upload the videos of the demonstrations, and a lot of teachers can access the contents easily. A webpage can connect more information than a handbook.

In order to improve our work qualitatively, we will verify the statements we proposed in the know-how of physics demonstrations and evaluate the educational effectiveness of the demonstrations we picked in the examples of physics demonstrations. Because we described the handbook just on our experience and on the knowledge of literatures, we have to evaluate the authenticity of the statements and the effectiveness on a scientific ground. These kinds of studies are challenging studies which have been continued from the early twentieth century [14]. We think there are two big problems to be resolved. The first problem is what to use as a scale to evaluate the statements and the effectiveness. We need careful discussions whether we should use ordinary exam scores or physics concept scales like FCI [16]. Then, if we can determine the scale, there is a problem how to measure the scale in our classes, for example, how to conduct the control experiment.

We will revise the handbook this year with newly accumulated knowledge, and more elaborated format. If the contents of handbook are improved to the enough level, we would like to open the contents all over the world.

## ACKNOWLEDGMENTS

Our collaborators include, Tatsuya Natsume, Masahiro Chikada, Toshiki Nakai, and Yoshiko Saitoh, the Center for the study of Higher Education, Nagoya University. We would like to thank to Shozo Suto for giving us valuable advises in his seminar, Toshifumi Shimizu for supporting to develop the apparatuses of the demonstrations, Mitsuhiro Nakamura and Ko Saitoh for showing us the demonstrations in their lectures. This work is supported by the grant of Presidential discretion of Nagoya University.

## REFERENCES

1. C. Taylor, *The Art and Science of Lecture Demonstration*, Taylor & Francis, New York, 1988.  
The new methods of demonstration are developed actively. For example, Sokoloff and Thornton have developed *Interactive Lecture Demonstrations*:  
D.R.Sokoloff and R.K. Thornton, *Interactive Lecture Demonstrations: Active Learning in Introductory Physics*, John Wiley & Sons, United States, 2004.
2. There are several case examples that students conduct experiments on the desks in a lecture room. For example, Personal Desk Labo, Center for General education, Chiba University, <http://gp.pdl.chiba-u.jp/index.html>  
We included this kind of experiments in our handbook.
3. G.Hattori, *Physics Lecture Experiments*, Seibundo Shinkosha, Tokyo, 1967.
4. T.Hyodo (supervisor), *Guide of Experiments to understand physics by seeing and with experience: collections of demonstrations and student's experiments*, Gakujyutsu Tosho Shuppan-sha, Tokyo, 2007.
5. K.Kinoshita, O.Aono, H.Fusaoka, "Demonstration in a physics lecture," *University Studies*, **12**, 1993, pp.117-123.
6. K.Kinoshita, T.Hyodo, H.Fusaoka, S.Kashiwamura, "Examples of demonstration modules," *University Studies*, **17**, 1996, pp.5-18.
7. K.Kinoshita, T.Hyodo, H.Fusaoka, S.Kashiwamura, "Classification and modularization of demonstration for lectures," *University Studies*, **17**, 1996, pp.189-198.
8. Nagoya University is one of the public, research universities in Japan. In 2010, there are 10,052 undergraduates, 6,556 postgraduates and 1,687 faculty members. In 2009, Nagoya U. is ranked in the world top 100 university by Times Higher Education.
9. Physics Lecture-Demonstration Facility, University of Maryland:  
<http://www.physics.umd.edu/lecdem/>
10. Physics Lecture Demonstrations Room, U.C. Berkeley:  
<http://www.mip.berkeley.edu/physics/physics.html>
11. Center for the studies of Higher Education in Nagoya University, *Seven Suggestions for Good Teaching and Learning at Nagoya University: faculty inventory*, 2005.
12. Prof. S.Suto, graduate school of science, Tohoku U.
13. R.Ehrlich, *Why Toast Lands Jelly-Side Down*, Princeton University Press, New Jersey, 1997.  
In this book, Ehrlich showed "Ehrlich's three laws" of demo. (1) Keep them simple, (2)Keep them pedagogically sound, and (3) Get the physics right. Our "laws" are slightly different in the second laws.
14. D. M. Majerich, J. S. Schmuckler and K. Fadigan , *Compendium of Science Demonstration-Related Research from 1928 to 2008*, Xlibris Corporation, United States, 2008.
15. J.Rabchuk, "The Gauss rifle and magnetic energy," *Phys. Teach.* **41**, pp.158-161 , 2003.
16. D. Hestenes, M. Wells, and G. Swackhamer , "Force Concept Inventory," *Phys. Teach.* **30**, pp.141-151, 1992.

Corresponding Author:

J.Yasuda, Assistant Professor, President's Office, Meijo University, Shiogamaguchi 1-501, Tempaku, Nagoya, Aichi, 468-8502, Japan.

Email: [jyasuda@meijo-u.ac.jp](mailto:jyasuda@meijo-u.ac.jp)

### 3.6 – Multimedia in teaching/learning

---



# Integrated e-Learning with remote experiments for engineering education in the era of networking

**Franz Schauer**

*Tomas Bata University in Zlín, Faculty of Applied Informatics, CZ-760 05 Zlín, Czech Republic and University of Trnava, Faculty of Education, Department of Physics, SK-918 43 Trnava, Slovak Republic*

## **ABSTRACT**

Information communication technologies have made it possible to introduce Integrated e-Learning (INTe-L) as a new strategy of education of physics for engineering education based on the method sciences used for the cognition of the Real world. It is based on the e-laboratory with remote experiments across the Internet, e-simulations and e-textbook. Its main features are the observations of real world phenomena, possibly materialized in data and their evaluation, search for relevant information, its classification and storing. Only then comes the explanation and the mathematical formalism of generalized laws and their consequences. The indispensable quality of this method is the active part the student has to take in the teaching process both in lessons, seminars and laboratory exercises, but also his/her substantially increased activity in form of projects, search for information, presentations etc. In this chapter, the INTe-L strategy is presented and general and pedagogical reasons for its introduction are given. The experience with INTe-L on teaching units Electromagnetic Induction, Oscillations, Photovoltaics and Electrochemistry is presented and discussed. We present the outlines of the existing and planned remote laboratory system with data transfer using Internet School Experimental System (ISES) as hardware and ISES WEB Control kit as software. We suggest an architecture for implementing remote laboratories based on standard and reusable ISES modules as hardware and Java supported ISES software. For this purpose, the LMS system Moodle turned out to be a highly effective means of organization of physics courses.

## **INTRODUCTION**

The physics teaching methods at secondary schools and universities face a critical stage of their development. The traditional way of delivering physics is used in the overwhelming majority of physics courses with its familiar characteristics. Most of the class time involves the teacher lecturing to students; assignments are typically homework problems with short quantitative answers. Seminars and especially laboratory work are more or less “recipes“ style usually only loosely bound to the time schedule of the lectures and examinations are largely based on written exams containing theory and a little of problem solving (Wieman & Perkins, 2005). Over the past couple of decades, physics education researchers have studied the effectiveness of such practices including extensive conceptual understanding, transfer of information and ideas from teacher to student in a traditional physics lecture, and beliefs about physics and problem solving in physics (McDermott and Redish, 1999; Adams, Perkins, Podolefsky, Dubson, Finkelstein, and Wieman, 2006). For reviews with useful citations, see references in (Wieman & Perkins, 2005). The definitive conclusion is that no matter what is the quality of the teacher, typical students in a traditionally taught course are learning mechanically, memorizing facts and recipes for problem solving, and are not gaining a true understanding. Equally alarming is that in spite of the best efforts of teachers,

typical students are also learning that physics is boring and irrelevant to understanding the world around them, including their future professions.

In all new emerging teaching technologies, the nearly unanimous opinion prevails about their most decisive feature - to remove the barriers to student's independent and exploratory work in all sorts of laboratories in elucidation of the real world (Wieman & Perkins, 2005; Thomsen, Jeschke, Pfeiffer and R. Seiler, 2005; Feisel and Rosa, 2005). The main possibility, without any dissenting voices for this trend, was to bring about the change in the physics laboratories in the direction of substituting the "recipe labs" (Domin, 1999) with research laboratories. It is very instructive in this respect to consult the still valid document, American Association of Physics Teachers (American Association of Physics Teachers, 1977), which formulated five goals the physics laboratory should achieve:

1. "The Art of Experimentation: The introductory laboratory should engage each student in significant experiences with experimental processes, including some experience designing investigation.

2. "Experimental and Analytical Skills: The laboratory should help the student develop a broad array of basic skills and tools of experimental physics and data analysis.

Computers, when used as flexible tools in the hands of students for the collection, analysis, and graphical display of data, can accelerate the rate at which students can acquire data, abstract, and generalize from real experience with natural phenomena. The digital computer is an important tool for an inquiry based course in physics because it has become the most universal tool of inquiry in scientific research. However, computer simulations should not be used as substitutes for direct experience with physics apparatus.

3. "Conceptual Learning: The laboratory should help students master basic physics concepts. The use of computers with laboratory interfaces allows real-time recording and graphing of physical quantities. The qualitative use of real-time graphing in microcomputer-based laboratories (MBL) has increased interest in using the laboratory to enhance conceptual understanding. The combination of two factors — laboratory course design based on an understanding of the preconceptions that students bring to the study of physics from their past experience, and the continuing development of MBL and other laboratory technology — has the potential to significantly improve the effectiveness of laboratory instruction.

4. "Understanding the Basis of Knowledge in Physics: The laboratory should help students understand the role of direct observation in physics and to distinguish between inferences based on theory and the outcomes of experiments.

5. "Developing Collaborative Learning Skills: The laboratory should help students develop collaborative learning skills that are vital to success in many lifelong endeavors."

Since 1977 till today, the Information Communication Technology (ICT) and computers have invaded all aspects of physics teaching. The present state of ICT development is characterized by reaching the level of the quantitative increase of parameters that are bringing about very deep qualitative changes. In an editorial to the recent issue of European Journal of Physics devoted to student undergraduate laboratory and project work, Schumacher [8] brings examples of the invasion of computers in contemporary laboratory work including project labs, modeling tools, interactive screen experiments, remotely controlled labs, etc., Schumacher closes with the plausible statement "One can well imagine that project labs will be the typical learning environment for physics students in the future" (Schumacher, 2007).

The present discussion about new teaching methods in physics is no longer directed towards fundamental changes in learning processes due to the new ICT, but how to introduce the new techniques into everyday teaching practice by establishing the resources of e-learning, curricula, etc. With this contribution, we intend to contribute to this discussion, introducing the new technology and strategy of physics education based on ideas the sciences use for their study of the real world – i.e. exploratory, discovery and ICT- the Integrated e-Learning (INTe-L).

The layout of the chapter is following. First, we want to give the motivation and pedagogical reasoning for INTe-L and how its components - remote e-experiments, e- simulations and e- textbooks - contribute to its goals. Second, we want to introduce the architecture and modules of suggested scheme of remote experiments using Internet School Experimental System (ISES) as hardware and ISES WEB

Control kit as software. The simplicity and applicability of the suggested architecture and INTe-L strategy and the first pedagogical experiences are then shown on examples of teaching units in Electromagnetic induction, Oscillations and Photovoltaics. In the outlook part of the chapter we point out the preparation steps of collaborative remote experiments in LMS (Maiti, 2010; Bochicchio, Longo 2009), leading to Socratic laboratory envisaged by Hake (1998) with introduction of “short” and “long” range feedback on one hand by usage of clickers in the lectures and seminars within INTe-L strategy (Perkins and Turpen, 2009) and on the other in tests, using the advantage of the average normalized gain  $\langle g \rangle$  as the measure of the effectiveness (Hake, 2007) of the INTe-L process.

## MOTIVATIONS AND PEDAGOGICAL REASONING FOR INTE-L

The first motivation of our work was very practical - the decreasing level of physics education and resulting knowledge and the reduced popularity of physics subjects among students. Physics is one of the most formidable subjects encompassing primary and secondary schools to technical universities with a logical consequence of decreasing level of physics knowledge (McDermott and Redish, 1999) and hours for physics education. This trend has been in progress for some two decades. The most probable cause for this state is the way physics is presented to the younger generation.

The second motivation and inspiration for INTe-L came from the inspiring papers of Wieman (Wieman and Perkins, 2005; Wieman, Adams and Perkins, 2008), supporting and calling for the change in educational technology, while seeing the remedy at hand in the existence of simulations. For this purpose, Colorado University started a very instructive Internet site PhET with many applets, covering the usual scope of physics topics. Thomsen and his co-workers introduced a new approach called e-LTR (eLearning, eTeaching, eResearch) using remote experiments (Thomsen, Jeschke, Pfeiffer and R. Seiler, 2005). Introducing eResearch, based on the e - laboratory, which is composed of remote Internet mediated experiments, they filled the missing link of e-Learning (Cikic, Jeschke, Ludwig, Sinha, and Thomsen, 2007). Very inspiring was a pioneering undertaking of building the RCL (Remotely controlled laboratories) in Kaiserslautern by Jodl (Gröber, Vetter, Eckert, and Jodl, 2008).

The third motivation came from our own work over the last two decades on computer-oriented hands on experiments and remote experiments. We have realized that the existence of the computer oriented experiments based on the hardware and software system ISES (see [www.ises.info](http://www.ises.info)) and remote experiments built on the same system (Schauer, Lustig, Dvořák and Ožvoldová, 2008) enabled the introduction of a new strategy of education allowed by these new teaching tools. On top of this, we suggest the architecture for implementing remote laboratories based on standard and reusable ISES modules as hardware and Java supported preprepared ISES software.

We introduced Integrated e-Learning with the following definition ( Schauer, Ozvoldova and Lustig, 2009): “INTe-L is the interactive strategy of teaching and learning based on the observation of real world phenomena by real e-experiments and e-simulations and on the principal features of the physic laws. It includes e-teaching tools as interactive e-textbooks and manuals and instructions which provide information and theoretical background for the understanding and quantification of observed phenomena”.

It is fair to notice that INTe-L introduced in our laboratory and defined in this way has very many common features of blended learning (Procter, 2003) combining face-to-face instruction with computer-mediated instruction, refuted by some pointing out that the term may be used for almost any form of teaching containing two or more different kinds of things that can then be mixed (Oliver and Trigwell, 2005) but not stressing the role of remote experiments and simulations. INTe-L differs substantially from Process integrated e-learning introduced several years ago (Jørgensen, Rolfsen and Krogstie, 2004) stressing the role of practical activities only.

The implementation of INTe-L into the teaching of physics is very demanding, attainable only with decisive support of ICT, - remote Internet experiments in e-laboratories for real world phenomena

observations (Gröber, Vetter, Eckert and Jodl, 2007), - Java or Flash applets in form of e-simulations as for instance in PhET in University of Colorado at Boulder (<http://phet.colorado.edu/new/index.php>) for the dynamical animations; - e-textbooks (Ožvoldová, Červeň, Dillinger, Halúsková, Laurinc, Holá, Fedorko, Štubňa, Jedinák, Beňo, 2007; F. Schauer INTe-L MOODLE Course in the Faculty of Informatics, Tomas Bata University in Zlin 2008 Mechanics, <http://vyuka.fai.utb.cz/login/index.php>). With this in mind, we suggest and already have started to practice the INTe-L and want to present the first results of the combined effort of several universities in the Czech and Slovak Republics.

## Components of INTe-L

The constituent components of INTe-L are, based on our definition and interpretation of INTe-L, namely Remote e-Experiments, e-Simulations and e- Textbooks. Let us briefly discuss these components.

### *Remote e-Experiments*

This component includes remote (or possibly hands-on) experiments. The technical achievements of ICT enable to build now Internet e-laboratories – comprising the set of real interactive experiments, globally distributed, accessible from any Internet connected computer, using the common web services (as web browser).

Many real remote e-laboratories across the Internet have issued providing experiments on real world objects, supplying the client with the view of the experiment, interactive environment for the experiment control and resulting data for evaluation. Three European activities arose interest in Remote physics laboratories, the project Pearl “ Practical Experimentation by Accessible Remote Learning “ (Cooper, 2005) the project Remote Farm (Cikic, Jeschke, Ludwig, Sinha, and Thomsen, 2007) and very inspiring was the pioneering undertaking - RCL (Remotely controlled laboratories) in Kaiserslautern by Jodl (Gröber,Vetter, Eckert, and Jodl, 2008).The gathered experience, the inventory of the state of the art and corresponding references in Europe and United States are to be found there. The normative goal in remote experiments sets up the project LiLa–Library of Laboratories (<http://www.lila-project.org/>)

With our work in the field we wanted to add to those activities in a constructive way. We know, from our own long lasting experience, once the university or the department and/or their teachers decide to build the RE, the main obstacle is often not the financial requirements of the RE, but the technical and know how of the ICT and the corresponding knowledge with the client-server communication and its establishing.. We offered the remedy to this situation and provide help with available hardware and software solutions enabling easy building of both computer based real experiments and their straightforward transformation to the real RE across the Internet (Schauer, Lustig, Dvořák and Ozvoldova, 2008). It is based on the scalable building set for the construction of natural science experiments, including physics, - ISES (Internet School Experimental System) (Schauer, Kuritka and Lustig, 2006) and ready for use software for easy and simple creation of remote experiments - ISES WEB Control (Schauer, Ozvoldova and Lustig, 2009). ISES Hardware, (see: [www.ises.info](http://www.ises.info), Figure 1.)

The computer interface card, with the inputs and outputs and the panel with plug-in slots for modules, provides an easy way of interfacing to virtually any PC compatible computer. The card is the 12-bit analogue-digital digital-analogue, time of conversion - 0.010 ms, DMA, and universal control board and a set of sensors (more then 40 for physics, chemistry, biology, etc.). The system offers the possibility of simultaneous measuring and data displaying for 8 input channels and process control via two analogue and four binary output channels. The analogue output channels work as programmable voltage sources (DC, AC with 8 kinds of default signals, manual controlling or user defined signals). A maximum sampling frequency (100 kHz) enables the study of sounds or other high frequency signals.



Figure 1. Internet School Experimental System (ISES): Hardware with the main panel, interface card and incomplete set of modules.

The ISES modules are easily interchangeable. The service program, provided with automatic calibration, automatically senses their presence and adjusts range accordingly. The system is equipped with such modules as e.g.: voltage ( $\pm 5 \text{ mV} \div 10 \text{ V}$ , Figure 2.), current ( $\pm 0.5 \text{ mA} \div 1 \text{ A}$ ), resistance, capacitance, temperature ( $-20 \text{ }^\circ\text{C} \div +120 \text{ }^\circ\text{C}$ , Figure 3.), microphone, deviation sensing unit, adjustable preamplifier, light stop, current booster, relay switch, pressure meter, and many others. For chemistry an electromagnetic valve for liquids and digital biretta have been recently developed.



Figure 1. V-meter;  
range  $10 \text{ mV} \div 10 \text{ V}$ .



Figure 1 Thermometer;  
range  $-20 \text{ }^\circ\text{C} \div +120 \text{ }^\circ\text{C}$ .

ISES Software (see: [www.ises.info](http://www.ises.info))

The service program enables the measurement of simultaneously 10 different channels (8 analogue inputs and 2 analogue outputs) as well as 4 binary output channels. All these modules are fully programmable, using the programming panel. The depicted quantities either by measured modules or combinations of modules arrived at through addition, subtraction, multiplication, division etc. The

software provides data processing (integration, differentiation, fitting, approximation etc.). The data export to another graphical processor is straightforward.

For the establishing the classical server-client connection with the data transfer from the server to the client and in the reversed direction for the control of the experiment by the client (experimentator) we built the software kit ISES WEB CONTROL (Schauer, F. Lustig and M. Ozvoldová, 2007) for the easy transformation of the computer oriented experiment based on the ISES system to RE, using only the web services, web pages and Java support on the client side based on the copy-paste principle of the prefabricated building blocks (Figure 4.) with only very limited knowledge of the rules of web pages creation using suitable editor at hand. The example of the www page of a remote experiment is in Figure 5.

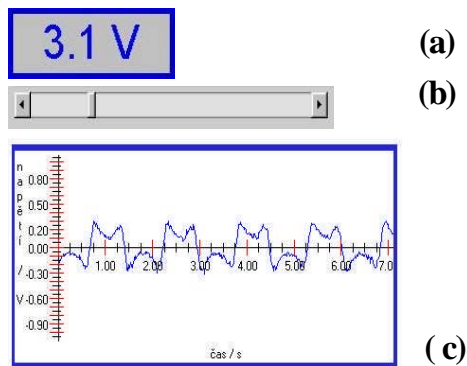


Figure 4. Examples of modular Java applets from ISES WEB Control kit as building tools and blocks for remote experiments web control pages (a) display, (b) control slide, (c) graph

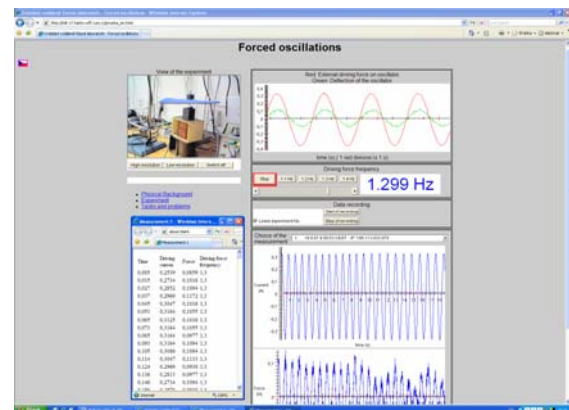


Figure 5. The web page on the client computer of the real remote experiment “Natural and driven oscillations” with live web camera view, frequency controls, graph of the measured data and the transferred data

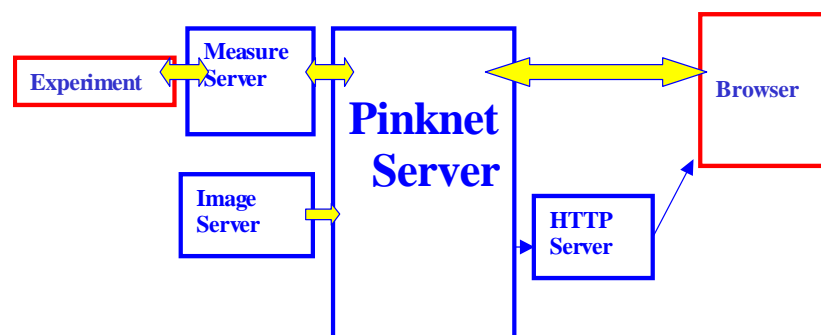


Figure 6. Schematical representation of the remote experiment setup with the Web server, Image Server, Measure Server and HTTP Relay Server.

The general scheme for the creation of the server-client connection using the CD software ISES WEB CONTROL kit is in Figure 6. This approach enabled the introduction of the complex study of real world phenomena based on data collection, their processing and evaluation, and comparison with the models (see our e-laboratories on [www.ises.info](http://www.ises.info) (Prague) and <http://kf.truni.sk/remotelab> (Trnava) ).

### *e-Simulations*

The e-simulations and modeling using both Internet available and home made Java or Flash applets (Wieman and Perkins, 2006) is indispensable part of INTe-L. They serve for the demonstration and explanation of observed phenomena and functioning of the concomitant physics laws. Surprisingly, the vast majority of applet simulations do not provide data output, which are needed for comparison of real experiments and models. For the multi-purpose simulation applets, we try to provide the data outputs to support (or contradict) the measured data with the model.

### *e- Textbooks*

The e-textbook covers theory, solved problems and exercises, glossary for quick orientation of the theory covered, multiple-choice tests with immediate evaluation of the acquired knowledge (Ožvoldová, Červeň, Dillinger, Halúsková, Laurinc, Holá, Fedorko, Štubňa, Jedinák, Beňo, 2007). Recently, the INTe-L course in Mechanics using LMS (Learning Management System) MOODLE was introduced using the general scheme of INTe-L, i.e. e-remote laboratory ([www.ises.info](http://www.ises.info) ), e-simulations and e-textbooks (F. Schauer INTe-L MOODLE Course in the Faculty of Informatics, Tomas Bata University in Zlin 2008 Mechanics, <http://vyuka.fai.utb.cz/login/index.php>).

### **Examples of teaching blocks with INTe-L**

We intend to demonstrate the first experiments in teaching physics using INTe-L with remote experiments on three teaching units from quite different parts of the physics course, namely Electromagnetic Induction, Oscillations, Photovoltaics and Electrochemistry.

All experiments are running on the server-client scheme, using normal web pages and web browser and Java support, no extra hardware or software is necessary on the client (student) side. The experiments are unique in available data transfer using the standard web page; the students can choose the range and the time interval of the wanted data for subsequent processing and evaluation.

#### *Teaching Unit Electromagnetic Induction*

The teaching unit examines the connection of time varying magnetic and electric fields into one entity of electromagnetic field, with the focus on the time varying magnetic fields and the ensuing consequences. The central focus of this unit is Faraday's law of electromagnetic induction.

Remote experiment - Faraday's law ( see : [www.ises.info](http://www.ises.info) )



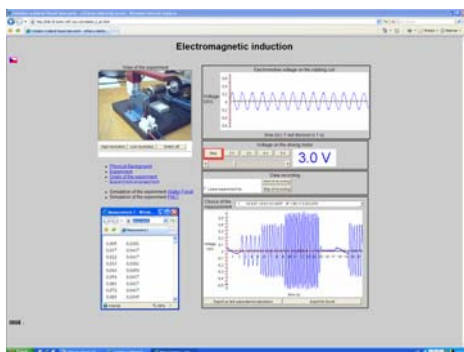


Figure 7. Web page of the remote experiment Faraday's law with controls, output data and the graph of the output voltage and the live image of the experiment by the camera ([www.ises.info](http://www.ises.info)).

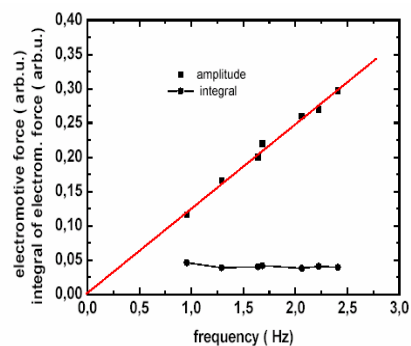


Figure 8. Dependence of the amplitude of the output voltage on the frequency of the rotation (upper curve) and its integral (down curve).

$$\int_0^{T/2} |\mathcal{E}| dt = \int_0^{T/2} NBS \omega \sin(\omega t) dt = 2NBS = konst$$

The start of the lecture in teaching the Electromagnetic induction unit is the introduction of the remote experiment as an observation of real world phenomenon, loaded with noise and other real world influences. To demonstrate Faraday's law by remote experiment ([www.ises.info](http://www.ises.info) or [http://kdt-17.karlov.mff.cuni.cz/pruzina\\_en.html](http://kdt-17.karlov.mff.cuni.cz/pruzina_en.html)), the coil is rotating in the homogeneous magnetic field (view in left top panel) at the constant but arbitrary variable frequency (see controls for changing the frequency of rotation and corresponding driving voltage for the motor (Figure 7.)). The resulting instantaneous electromotive voltage (right top panel) is transferred to the web page of the experiment – see the collected data (left bottom panel) and the corresponding time representation (right bottom panel). The web page is supplemented by the texts, providing the necessary theory and resources.

It is worth mentioning that the experiment may be used in different phases of the lecture (motivation, discussion, phenomenon evaluation etc.). It may also be introduced in a computational lesson and laboratory exercise and also for student project work (see the sample of the evaluation from the project work in Figure 8.), self study, and preparation for examination (with advantage during the examinations) (Schauer, M. Ozvoldova, F. Lustig and M. Dekar, 2008).

e-Simulation - Faraday's law. The e-simulation of the phenomenon comes next in the lecture. For this purpose, we use the sophisticated and very useful applets provided by the PhET - Colorado University project (<http://phet.colorado.edu/new/index.php>). Using the simulations, we present the model of the above demonstrated real world experiment. Here the students may qualitatively observe and study the influence of variable parameters of the setup.

E-Textbooks. The lesson then continues using the necessary theoretical framework presentation by the teacher including using the data collected during the presentation. For this purpose the e-textbook is used, which is one compiled by a team of Slovak physics teachers and covering the basic physics course (Ožvoldová, Černanský, I. Červeň, J. Budinský J. and R. Riedlmajer, 2006). Students are encouraged to use the e-textbook throughout their study of physics in seminars, laboratory work, and preparation for examinations. The major advantage, appreciated by students, is availability across the Internet and its lucid presentation of materials. We stimulate the students to examine and verify the validity of the physics laws in "action" in their seminars and project work.



### Teaching Unit Oscillations

Oscillations constitute one of the most important parts of physics. The goal of the basic course of Physics in the chapter of oscillations is to show the oscillatory movement as a basis of nearly all natural phenomena. The unifying model for all real world systems then may be the mass-spring system constituting the driven mechanical oscillator.

Remote experiment – Oscillations ( [http://kdt-17.karlov.mff.cuni.cz/pruzina\\_en.html](http://kdt-17.karlov.mff.cuni.cz/pruzina_en.html) )

In our illustration of Integrated e- Learning in the practical teaching process the starting point of the lecture is the remote experiment of the forced oscillations available across the Internet ([www.ises.info](http://www.ises.info) or [http://kdt-20.karlov.mff.cuni.cz/ovladani\\_2\\_en.html](http://kdt-20.karlov.mff.cuni.cz/ovladani_2_en.html)) ( Figure 9. and Figure 10.). These data give information about frequency, the instantaneous value of the driving force, and the instantaneous deflection giving both amplitude of the forced oscillations and their corresponding phase. The usage of the experiment is manifold, determining the own frequency of the oscillator, its damping, the resonance, the amplitude and phase transfer functions and the energy transfer from the source of the driving force to the oscillator. If used in the student's laboratory, the students are encouraged to process the acquired data, evaluate the requested quantities of the model oscillator, discuss the obtained results, and critically assess the errors of the measurements. Figure 10. depicts the energy transferred in unit time from the driving force generator to the oscillator, as a function of the frequency of the driving force, damping being the parameter. The students are encouraged to find examples of the energy transfer in the natural phenomena and in technique. Such experiments may also be used with advantage for self-study of students, during examinations and may be very useful for part time students, where laboratories are not standard.

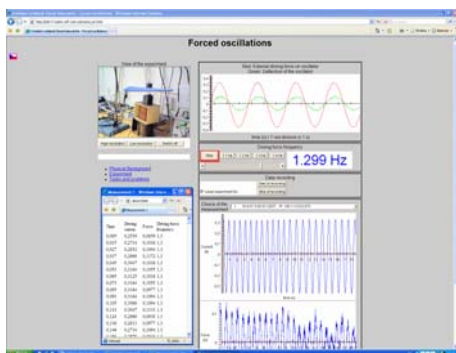


Figure 9. Web page of the Remote Experiment Oscillations with the live image of the experiment (top left), graph of the time representations, controls and output data

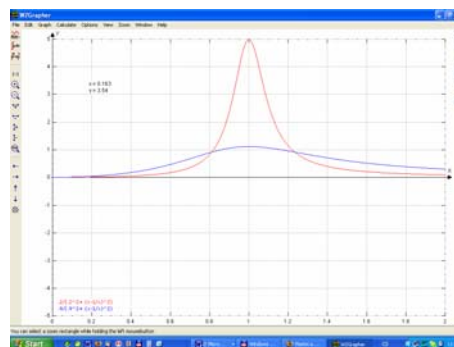


Figure 10. Energy transfer from the driving force generator to the oscillator vs. frequency of the driving force with damping as parameter (lower damping-upper curve and higher-lower curve).

E-Simulation - Oscillations . In this simulation nearly identical observations to that of the above-presented remote experiment may be carried out. Forced oscillations simulation provides the same sets of the data as in the simulation, and were compiled by Walter Fendt (<http://www.walterfendt.de/ph14e/resonance.htm>). The Java applet provides the simple schematic dynamic view of the oscillator; its driving force (red) and weight deflection (blue) and the corresponding time representations in the graph. The adjustable parameters are spring stiffness, mass of the weight and attenuation with driving force frequency.

### Teaching Unit Photovoltaic (PV) cell

This teaching unit has at present a strong environmental justification and serves as an example of the possibility to teach by INTe-L also more abstract, scientific in nature, and theory oriented topics from material science and solid state physics.

#### Remote Experiment–Photovoltaic Cell

( [http://kdt-4.karlov.mff.cuni.cz/vacharakteristika\\_2\\_en.html](http://kdt-4.karlov.mff.cuni.cz/vacharakteristika_2_en.html)) Photovoltaic Cell remote experiment is depicted in Figure 11.(web page) and Figure 12.(I-V characteristics). This is a popular real-world experiment interesting both from the physical and environmental views.

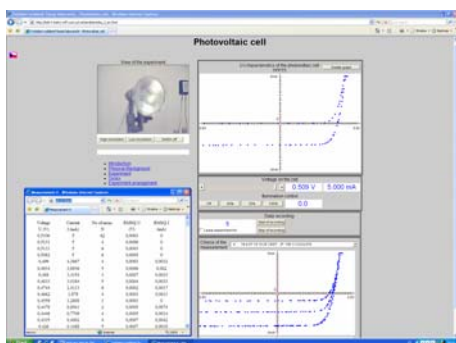


Figure 11. Web Page of the remote experiment photovoltaic cell characterization with controls, live web camera image and graph of the I-U characteristics

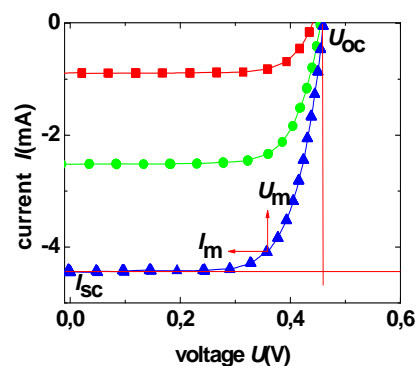


Figure 12. I-U characteristics of the illuminated photovoltaic cell for three relative light intensities: L (triangles), 0.7 L (circles) and 0.4 L (squares).

We have recently devised this sophisticated version of this experiment as an example of the possibility to use remote experiments in material science (Schauer, Lustig and Ozvoldova, 2007). The students were encouraged to study the quality factor of the dark current  $I-U$  characteristic of the photovoltaic cell and fill factor of the illuminated device that is decisive for the efficiency of the radiation to electrical energy transformation. The measurements are straightforward; the focus is then on the data evaluation. The extra variable parameter is the intensity of light of the PV element. The students faced no problems with data transfer, but had to cope with some problems as to the physical phenomena involved and data evaluation.

#### E-Simulation - Photovoltaic Cell .

We use for this unit the excellent applet from the Australia National University in Canberra which provides support solar radiation data for the solar cell device and its energy output .

We have recently build the remote experiment from electrochemistry - Electrochemical cell ([remotelab2.truni.sk](http://remotelab2.truni.sk)). The schematical representation of the experiment is in Figure 13. and www page is in Figure 14. It consists of the two reaction chambers with variable concentration of electrolytes,

connected by the membrane and two metal electrodes. Several new ISES components were devised - titration pump, electromagnetic valve and stirring device. The principle of the experiment is simple – changing the concentration of the electrolyte, the validity of the Nernst equation is tested by the measuring the electromotive force of the cell, combined with the conductometric and pH data (Ozoldova1,F. Schauer , P. Cernansky, Z. Gerhatova, L. Tkac and M. Beno, 2010).

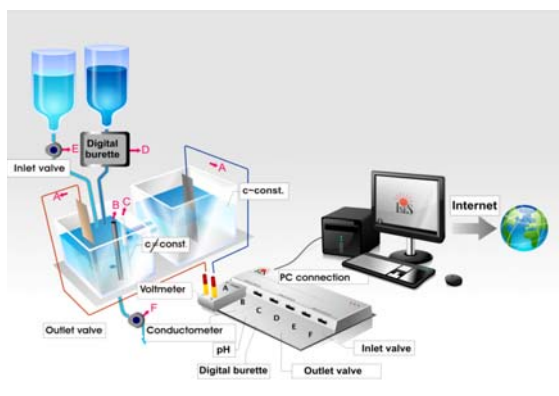


Figure 13. The schematical arrangement of the remote interactive experiment Electrochemical cell; the Department of Physics, Faculty of Pedagogy of Trnava

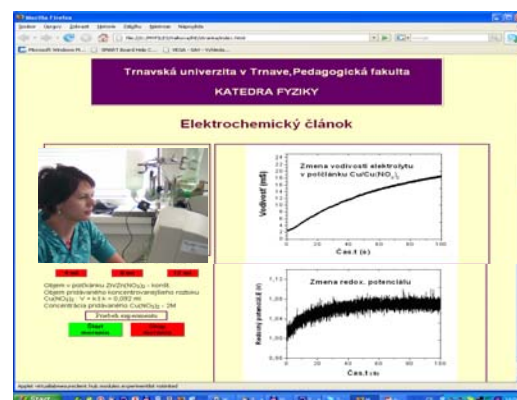


Figure 14. WWW page of the remote experiment Electrochemical cell.

All units of INTe-L were delivered within the basic course of physics to the students of Informatics. The course was implemented in the LMS system Moodle, whose front page is in Figure 15. In Figure 16. and Figure 17. are examples of INTe-L of a lecture and a seminary. We keep to a rule to minimize the number of experiments and simulations, but try to keep them in all forms of classes, i.e. lectures and seminars. As we found, the prerequisites for the application of INTe-L are the carefully prepared supporting materials, cooperative interplay of all teachers and instructors in lectures, seminars and laboratory exercise, and perfect function of all components of ICT. We used during the course the standard COLLES (Constructivist On-Line Learning Environment Survey) Figure 18.

Discussion of benefits of INTe-L among the teachers of physics gives the prevailing opinion for the necessity of physics teaching strategy change. In their recent paper on the physics education transformation, C. Wieman (Wieman & Perkins, 2005) ask the general question “Is there a way to teach physics that does not produce such dismal results for the typical student?” They give the positive answer by using the tools of physics in their teaching; instructors can move students from mindless memorization to understanding and appreciation. Many educators solve this problem by different approaches, many of them by increasing the role of laboratories - either real computer oriented (Schauer, F. Lustig, J. Dvořák and M. Ožoldová, 2008, real e-laboratories across the Internet (Gröber, Vetter, Eckert and Jodl, 2007) or virtual laboratories and simulations (Wieman and Perkins, 2006).



Figure 15. The front page of the LMS Moodle for the course delivered in INTe-L.

**Lesson 5. Newton's laws of dynamics**

**Experiment on Internet:  
Mechanical oscillator**

**Questions:**

1. Why the weight on the spring moves periodically ?
2. Why this periodic motion after some time ceases?

**NEWTON, sir Isaac**  
1643-1727

**Let us try this simulation on motion due to a force**

**Figure 16. Example of INTe-L Moodle page: Lecture on Newton's laws.**

**Seminary 5.- Newton's laws**

**Test : Which trajectory is correct?**

**Verify the calculation by the simulation**

1. In the depicted simulation the body of the mass  $M = 0.125$  kg is pulled by the weight of the mass  $m = 5.2$  g. The bodies move, so the trajectory as a function of time is  $x = 0,1 t^2$ . Find the coefficient of friction of a body and the substrate.

**Figure 17. Example of INTe-L: Seminary on Newton's Laws.**

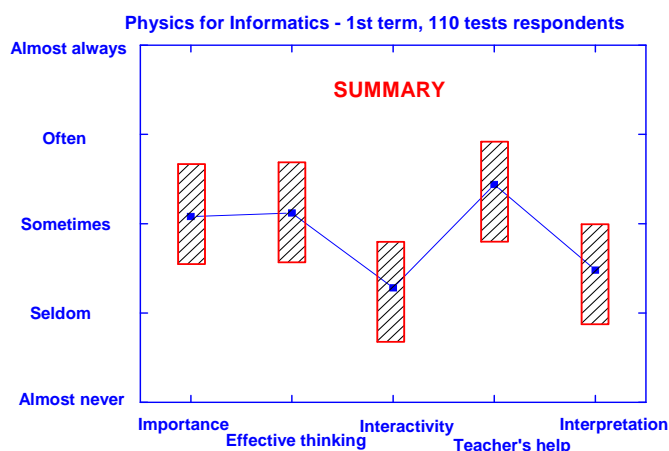


Figure 18. Results of standard Colles inquiry on Moodle course based INTE-L teaching strategy.

We adhere to the opinion that laboratories and simulations can deeply change the education in physics, but new strategies, including these new teaching tools, are needed. For that reason, we suggested the method of Integrated e-Learning and the question arises, if INTe-L solves the present difficulties in physics teaching and complies with the findings, what do physics education researchers bring to the effectiveness of education process (Mayer, 2003). The prospective methods of teaching, including INTe-L, should comply with the general piece of knowledge coming from cognitive research that (Bernhard, J. 2001; Rubin D.C. and Wenzel, A.E, 1996) :

1. Students should be provided with a suitable organizational structure, based on his/her prior thinking and experience and starting from their own research results. We should not simply be pouring facts on them and not addressing the simple questions "what", but rather "why". On top of this, previous knowledge must be carefully checked and examined and possible misconceptions dispelled. The ultimate goal in this respect should be active thinking, active exploratory work, guided by the active role of the teacher, and conditioned by the double-sided interaction of student – teacher.
2. The traditional teaching of “the rules” brings excessive amounts of new material that is far more than a typical person can process or learn. The more cognitive load the brain is given, the less effectively it can process anything and at the same time it is blocked from processing and mastering new ideas. This is one of the most well established and widely violated principles in education, including by many education researchers in their presentations. Any new method that should bring remedy to the situation and maximize learning should minimize the cognitive load by minimizing the amount of presented material. Presentations should be well organized structures and make the link to the already known ideas of the audience.
3. The third important criterion concerns the students and public beliefs about physics education and the importance of physics for society. If the belief about the purely abstract nature of physics and its not addressing the problems of the real world prevail, it deeply influences the approach towards the physics as a subject and the necessity of its mastery.

How does the INTe-L address these three criteria? The first above mentioned criterion is met by INTe-L from its starting point, observations, irrespective if it is traditional computer based laboratory, remote real e-laboratory across the Internet or virtual e-laboratory (Lustig, Schauer, Ozvoldová, 2007). The real experiments strongly support the examination of the real world. On the other hand, the virtual laboratories or simulations support an interactive approach, employ dynamic feedback, follow a

constructivist approach, provide a creative workplace, make explicit otherwise inaccessible models or phenomena, and inspires students productively (Finkelstein, Adams, Keller, Perkins, Wieman and the PhET Team, 2006).

The cognitive load in INTe-L is limited by supporting the individual comprehension processes offering manifold accesses to knowledge and being individually adaptive, offering significant advantages in the individual rates of teaching progress. Traditional teaching scenarios cannot satisfy this requirement, particularly because of cognitive capacity issues. INTe-L environments meet these needs. The possibility of making abstract objects and concepts tangible by application to real and virtual laboratories demonstrates this qualitative change in education and addresses the diminishing of the cognitive load of students (Thomsen, Jeschke, Pfeiffer and R. Seiler, 2005).

In the fulfillment of the third criterion, INTe-L brings, the qualities and skills the students acquire studying physics courses for their future study and professional careers. In practical teaching it means assigning problems that are graded strictly on a final number, or that can be done by plugging the correct numbers into a given procedure or formula. This approach can teach students that solving physics problems is only about memorization and coming up with a correct number—reasoning and seeing if the answer makes sense are irrelevant. The good news is that courses that make rather modest changes to explicitly address student beliefs have avoided the usual negative shifts. Those changes include introducing the physics ideas in terms of real-world situations or devices with which the students are familiar; recasting homework and exam problems into a form in which the answer is of some obvious utility rather than an abstract number; and making reasoning, sense-making, and reflecting explicit parts of in-class activities, homework, and exams .

The easier access of majorities and disabled to the physics education is also contributing, including globalization features. Technologies are a prerequisite for the continuous integration of internationalized studies: transparency of course content forms the basis for the international recognition of academic achievements, eases the formulation of rules of acknowledgement for studies in foreign countries, making a stay abroad considerably easier to manage and realize. Geographical proximity, previously a pre-requisite for intensive cooperation, is diminishing in impact.

Application of new media and new technologies has resulted in a significant impact on research. Today ICT is the technical foundation to access scientific sources and data. Interdisciplinary questions are getting more important and the possibility for interdisciplinary communication and cooperation plays a significant role.

## **FUTURE RESEARCH DIRECTIONS**

The examination of the effectiveness of INTe-L is under way. For this purpose we apply standard pedagogical methods of inquiry and questionnaire, the log-in protocols in remote experiments, and the records of remote experiments measurements. Our ultimate goal is to prepare the basic physics course curriculum with the above mentioned scheme, using the remote e-experiments, e-simulations and e-textbook. For this, the corresponding set of remote experiments has been prepared in Prague ( see [www.ises.info](http://www.ises.info)) “Standing waves in the resonator“, “Magnetic field generation and mapping“, “Electrochemical sources of energy“, “Free fall in gasses and liquids” to those already functioning “Controlling of the liquid level“, “Monitoring the environment in Prague“, “The electromagnetic induction“, “The forced mechanical oscillator“, “Diffraction of microobjects“, “Heisenberg principle of uncertainty“, and “Characterization of the photovoltaic device” The second e-laboratory of remote experiments was built in Trnava (Slovak republic) (Ozvoidova, Schauer, Cernansky, Gerhatova, Tkac and Beno, 2010): (<http://kf.truni.sk/remotelab> or [http://remotelab N.truni.sk](http://remotelab.N.truni.sk), where N =1, 2, 3...5 ) Environmental monitoring in Trnava N=1, Electrochemical cell (see Figure 13. and Figure 14.) N=2, Energy transfer in oscillator (N=3), Free fall(N=4) and Mathematical pendulum(N=5). The third laboratory is being formed in Zlin, where students of Applied informatics at Tomas Bata University have built their first ISES and ISES WEB CONTROL KIT remote experiments (see Water management <http://195.178.94.141/> and Photovoltaic cell <http://195.178.94.142/> ) and student physics server

(<http://195.178.94.31/> ). The great advantage is the support of the University authorities and the Accreditation commission for these activities. The infrastructure of the teaching process must be changed accordingly. The whole potential offered by the INTe-L will be realized only if it is embedded in the existing academic structure.

After several years of working with INTe-L in practical teaching and learning we are engaged in its improvement in three major directions, namely

- Increasing the bilateral and multilateral communication teacher – student, student - student(s) in all forms of education as proposed by Hake in his Socratic pedagogy (Hake 1998 ;Hake, 2007), but especially by adding collaborative features to Moodle along the lines suggested in (Bochicchio and Longo, 2009) using the principles of Web Collaborative Laboratory (WeColLab),
- Embedding the remote laboratories in the collaborative lab activities (Maiti, 2010), using the principles of Computer-Supported Collaborative Learning (CSCL),
- Increase the “ short range “ feedback in lectures by introducing the voting system (“clippers”) as suggested by e.g. (Perkins and Turpen, 2009). The only problem to be solved is the capacity of the system for 150- 200 students in the class and from this stemming awkwardness in operation. The feedback in seminars has been introduced by class management system, as every students working place in a typical physics (and laboratory as well) is equipped with web connected PC. To introduce systematically as the measure of the average effectiveness of a course in promoting conceptual understanding the average normalized gain  $\langle g \rangle$  defined as the ratio of the actual average gain ( $\% \langle post \rangle - \% \langle pre \rangle$ ) to the maximum possible average gain (Hake, 1998).

## CONCLUSION

Our long lasting activities in the computer based laboratory system software and hardware system ISES exploitation (Schauer, F. Lustig, J. Dvořák and M. Ožvoldová, 2008), remote e-laboratories building using ISES(Ozvoldova, Schauer, Cernansky, Gerhatova,Tkac and Beno, 2010), together with the stimulating activities on transformation of physics education elsewhere (Wieman & Perkins, 2005; (Thomsen, Jeschke, Pfeiffer and R. Seiler, 2005) gave rise to our incentives to devise and suggest the strategy of education INTe-L that may positively influence teaching of physics.

In general, INTe-L complies with the general criteria physics education researchers suggest for the effectiveness of education process:

1. Suitable organizational structure, based on his/her prior thinking and experience;
2. It reduces the cognitive load by supporting the individual comprehension processes offering manifold accesses to knowledge and being individually adaptive; and
3. It positively addresses the students and public beliefs about physics education and physics importance of physics for society.

The INTe-L, as a new strategy of education, calls for deep changes in the University life as the infrastructure of the teaching process must be changed accordingly as the exploitation of the whole potential offered by the INTe-L may be employed only if it is embedded in the academic structure.

## REFERENCES

Adams, W. K., Perkins, K. K., Podolefsky, N. S., Dubson, M., Finkelstein, N. D., and Wieman, C. E. (2006). New Instrument for Measuring Student Beliefs about Physics and Learning Physics: The Colorado Learning Attitudes about Science Survey, *Phys. Rev. Spec. Topics - Phys. Educ. Res.*, 2, 010101.



American Association of Physics Teachers 1977 (1990), In A. B. Arons (Ed.), *A Guide to Introductory Physics Teaching*. Wiley, New York.

Bernhard, J. (2001). Does Active Engagement Curricula Give Long-Lived Conceptual Understanding? In Pinto, R., and Surinach, S. (Eds) *Physics Teacher Education Beyond 2000* (pp. 749–752), Elsevier, Paris. (Retrieved 14.10.2010 <http://www.ncsu.edu/sciencejunction/route/professional/labgoals.html> ).

Bochicchio, Mario A., and Longo, A. (2009). Hands-On Remote Labs: Collaborative Web Laboratories as a Case Study for IT Engineering Classes. *IEEE Transactions on Learning Technologies* 2 (4) 320-330.

Cikic, S., Jeschke, S., Ludwig, N., Sinha, U., and Thomsen, C. (2007). Networked experiments and scientific resource sharing in cooperative knowledge spaces. *Interactive Technology and Smart Education*, 4(1), 19 – 30.

Cooper, M. (2005). Remote laboratories in teaching and learning – issues impinging on widespread adoption in science and engineering education, *iJOE (International Journal of Online Engineering)* 1 (1).

Domin, D. S. (1999). A Review of Laboratory Instruction Styles. *Journal of Chemical Education*, 76, 543-547.

Feisel, L. D. and Rosa, A. J. (2005) The Role of the Laboratory in Undergraduate Engineering Education. *Journal of Engineering Education*, 93, 121.

Finkelstein, N. D., Adams, W., Keller, C., Perkins, K., Wieman, C. (2006). High-Tech Tools for Teaching Physics: The Physics Education Technology Project. *MERLOT Journal of Online Learning and Teaching*, 2(3), 109.

Gröber, S., Vetter, M., Eckert, B., and Jodl, H. J. (2007) Experimenting from a Distance – Remotely Controlled Laboratory (RCL), *Eur. J. Phys.*, 28(5), 127.

Hake, R. R. (1998). Interactive-engagement versus traditional methods: A six-thousand-student survey of mechanics test data for introductory physics courses. *Am. J. Phys.* 66, 64.

Hake, R. R. (2007). Six Lessons From the Physics Education Reform Effort. *Latin American Journal of Physics Education* 1(1), 24.

Hunter, C., Wardell, S., and Wilkins, H. (2000) “Introducing First-Year Students to Some Skills of Investigatory Laboratory Work. *University Chemistry Education*, 4, 14-17.

Johnstone, A. H., Sleet, R. J., and Vianna, J. F. (1994). An Information Processing Model of Learning: Its Application to an Undergraduate Laboratory Course in Chemistry. *Studies in Higher Education*, 19, 77-87.

Jørgensen, H. D., Rolfsen, R. K., and Krogstie, J. (2004). Process-Integrated eLearning, in *Proceedings of Workplace Learning – from the learners perspectives*. In WL 2004 Copenhagen 25.-27. November.

Lustig, F., Schauer, F. Ožvoldová, M. (2007). E-Labs in Engineering Education: Classical, Real Remote or Virtual?. Conference ICTE 2007 (pp. 107-116), Technical University of Ostrava, Rožnov pod Radhoštěm.



Maiti, N.(2010). NETLab: An Online Laboratory Management System. *iJOE(International Journal of Online Engineering )* 6(2)31-36.

Mayer, R. (2003) Learning and Instruction. Merrill, Upper Saddle River, NJ.

McDermott, L.C. and Redish E.F. (1999). Resource Letter: PER-1: Physics Education Research. *Am. J. Phys.*, 67(9), 755.

Oliver, M., and Trigwell, K.(2005).Can ‘Blended Learning’ Be Redeemed? *E-Learning* 2(1), 17.

Ožvoldová, M., Černanský, P., Červeň, I., Budinský J. and Riedlmajer, R. Introduction into Engineering Physics-a Multimedia CD Tool for Students Entering the Slovak Engineering Universities. *Innovations 2006: World Innovations in Engineering Education and Research, iNEER Special Volume 2006* (pp. 228 –234). Virginia, USA.

Ožvoldová, M., Červeň, I., Dillinger, J., Halúsková, S., Laurinc, V., Holá, O., Fedorko, V., Štubňa, I. Jedinák, D., Beňo, M.( 2007). Multimedia university textbook on physics Part 1, Trnava Univerzity, Faculty of Education.

Ozvoldova,M., Schauer, F., Cernansky,P., Gerhatova,Z., Tkac,L., and Beno,M.(2010).1<sup>st</sup> Slovak Internet Natural Sciences Remote e-Laboratory (INRe-L). REV - Remote Engineering & Virtual Instrumentation conference June 29 – July 2, 2010, Stockholm.

Perkins, K. K., and Turpen, C. (2009). Student Perspectives on Using Clickers in Upper-division Physics Courses. Physics Education Research Conference 2009, Part of the PER Conference series, , 1179 (pp.225-228). Ann Arbor, Michigan: July 29-30.

Procter,C.(2003). Blended Learning in Practice Education in a Changing Environment. Conference Proceedings published by the University of Salford, Retrieved 14.7.2010 from <http://www.edu.salford.ac.uk/her/>.

Rubin D.C. and Wenzel, A.E.(1996). One Hundred Years of Forgetting: A Quantitative Description of Retention. *Psychol. Rev.* 103(4), 734.

Schauer, F., Kuritka, I.,and Lustig, F. (2006). Creative Laboratory Experiments for Basic Physics Using Computer Data Collection and Evaluation Exemplified on the Intelligent School Experimental System (ISES). *Innovations 2006: World Innovations in Engineering Education and Research, iNEER Special Volume 2006* (pp.305-312). Virginia, USA.

Schauer, F., Lustig, F., and Ozvoldová M.(2007) Remote Material Science Internet Experiments Exemplified on Solid State Photovoltaic Cell Characterization. *Journal of Materials Education*, 29(3-4), 193-200.

Schauer, F., Lustig, F., Dvorak,J., and Ozvoldová, M. (2008a). An Easy-to-Build Remote Laboratory with Data Transfer Using the Internet School Experimental System. *Eur. J. Phys.*, 29, 753-765.

Schauer, F., Ozvoldova, M., Lustig, F., and Dekar, M. (2008b). Real Remote Mass-Spring Laboratory Experiments across Internet - Inherent Part of Integrated E-Learning of Oscillations. *International Journal of Online Engineering (iJOE)*,4(2), 52-55.

Schauer, F., Ozvoldova, M., and Lustig, F. (2009). Integrated e-Learning – New Strategy of Cognition of Real World in Teaching Physics. *Innovations 2009: World Innovations in Engineering Education and Research, iNEER Special Volume* (pp. 119-135). Virginia, USA.

Schumacher, D. (2007). Student Undergraduate Laboratory and Project Work. *Eur. J. Phys.*, 28(5), Editorial.

Thomsen, C., Jeschke, S., Pfeiffer, O., and Seiler, R. (2005). e-Volution: eLTR - Technologies and their Impact on Traditional Universities, *Conference EDUCA online*, ISWE GmbH, Berlin.

Wieman, C.E. & Perkins K. (2005). Transforming Physics Education. *Physics Today*, 58, 26-41.

Wieman, C., and Perkins, K. (2006). A Powerful Tool for Teaching Science. *Nature Physics*, Vol. 2, 290.

Wieman, C. E. , Adams, W.K., and Perkins, K.K. (Science). PhET: Simulations that Enhance Learning. *Science* 322, 682-683 .

## KEY TERMS & DEFINITIONS

**Integrated e-Learning (INTe-L)**

INTe-L is the interactive strategy of teaching and learning based on the observation of real world phenomena by real e-experiments and e-simulations and on the principal features of the physics laws. It includes e-teaching tools as interactive e-textbooks and manuals and instructions which provide information and theoretical background for the understanding and quantification of observed phenomena

**Process-Integrated eLearning**

is a teaching process, where a closer integration between learning and work is achieved by rather simple means as course design, organizational knowledge management, and information system customization. In this sense it has nothing to do with INTe-L proposed by the present author.

**Blended Learning**

is the effective combination of different modes of delivery and models of teaching.

**Socratic Method of Pedagogy (Teaching by Asking Instead of by Telling)**

The Socratic Method is a negative method of hypothesis elimination, in that better hypotheses are found by steadily identifying and eliminating those that lead to contradictions. The Socratic Method searches for general, commonly held truths that shape opinion, and scrutinizes them to determine their consistency with other beliefs. The basic form is a series of questions formulated as tests of logic and fact intended to help a person or group discover their beliefs about some topic.

**Socratic Dialogue Inducing Courses**

Physics courses with various innovations emphasizing interactive engagement of students as opposed to traditional method. The basis is the set of questions that helps to shape and formulate the hypothesis concerning the observed phenomenon.

### Voting system (Clickers)

Clickers are any wireless personal response (voting) systems that can be used in a classroom to anonymously and rapidly collect an answer to a question from every student; an answer for which they are individually accountable. This allows rapid reliable feedback to both the instructor and the students. Clickers are not a magic bullet – they are not necessarily useful as an end in themselves. They become useful when the instructor has a clear idea as to what they want to achieve with them, and the questions are designed to improve student engagement, student-student interaction (on-topic), and instructor-student interaction. Below are some resources to help instructors use clickers effectively in a classroom.

### Learning management systems (LMS)

A learning management system is a software application for the administration, documentation, tracking, and reporting of training programs, classroom and online events, e-learning programs, and training content.

### Computer-Supported Collaborative Learning (CSCL)

Combines networked laboratory summing up the best aspects of hands-on experiences and the best features of the Web. The distance laboratory must foster active learning and comprehension construction by the student. In the social setting of the in-lab experience, the learner interacts directly with other students, the instructor, equipments, activities, and other elements. These interactions guide interpretation and construction of concepts.

### Web Collaborative Laboratory (WeCollab)

is equipment-independent system enabling the remote control of real laboratory equipments, letting groups of students share their lab experiences in a multiconference session, and managing the security features over the Web.

### Class Management System (CMS)

The software system enabling the collaborative interaction of teacher – student student – teacher or teacher – students of the class .

## **ADDITIONAL READING SECTION**

### **General aspects of physics teaching**

Bacon, D., and Stewart, K. (2006). How fast do students forget what they learn in consumer behavior? A longitudinal study. *J. Mark. Education* 28(2), 181.

Barbera, J., Adams, W.K., Wieman, C.E., and Perkins, K.K. (2008). Modifying and Validating the Colorado Learning Attitudes about Science Survey for Use in Chemistry. *Journal of Chemistry Education* 85,1435-1439

McDermott, L., and Shaffer, P.(2002). Tutorials in Introductory Physics. NJ .Prentice Hall, Englewood Cliffs.

Perkins, K.K., Barbera, J., Adams, W.K., and Wieman, C.E.(2006). Chemistry vs. Physics: A Comparison of How Biology Majors View Each Discipline. *PERC Proceedings 2006. AIP Press.* 883, 53.

Wixted, J., and Ebbesen, E. (1991). On the Form of Forgetting, *Psych. Science* 2, 409.

### **Remote laboratories**

Altherr, S., Wagner, A., Eckert, B., and Jodl, H. J. (2004). Multimedia material for teaching physics (search, evaluation and examples). *Eur. J. Phys.* 25,7–14.

Gröber, S., Vetter, M., Eckert, B., and Jodl, H.J. (2008). Remotely controlled laboratories: Aims, examples, and experience. *Am.J. Phys.* 76(4 & 5), 374.

Jeschke, S., Scheel, H., Richter, T., Thomsen, C. (2007). On Remote and Virtual Experiments in eLearning, *J. of Softw.*2(6),76.

Podolefsky, N.S., Adams, W.K., and Wieman, C.E. (2009). Student Choices when Learning with Computer Simulations, PERC Proceedings 2009, AIP Press.

Thomsen, C., Scheel, H., and Morgner S.(2005). Remote experiments in experimental physics. Proceedings of the ISPRS E-Learning, June 1-3, Potsdam/Germany. Retrieved 14.7.2010 from <http://www.isprs.org/proceedings/XXXVI/6-W30/>

### **Clickers**

Perkins, K. K., and Turpen, C. (2009). Student Perspectives on Using Clickers in Upper-division Physics Courses. Physics Education Research Conference 2009, Part of the PER Conference series, , 1179 (pp.225-228). Ann Arbor, Michigan: July 29-30.

### **Cooperation in LMS and RE:**

Bochicchio M.A., Longo A.(2010). Adding Collaborative Remote Lab activities to Moodle. Conf. REV, 29 June - 2 July, , p.259, Stockholm.

# From linear text to hypermedia in Physics educational documents

**Authors:** Víctor López ([Victor.lopez@uab.cat](mailto:Victor.lopez@uab.cat)), Roser Pintó

**Affiliation:** CRECIM (Research Centre for Science and Mathematics Education)

**Keywords:** hypermedia, Internet, ICT.

## Abstract:

This paper presents a discussion about how to transform Physics' educational documents from printed-support to digital-support. We have not only looked at the technical features of a digital document, but we have also taken into account how students learn and which specificities of Physics must be faced in the process.

The result is a set of transformation guidelines presented in order to improve the educational quality of Physics teaching and learning materials, enhancing all the hypermedia potential. Guidelines are composed by three simultaneous itineraries: transforming from linear text into hypertext, from static pictures into multimedia files and from problem statements into embedded interactive applications.

## 1. Context

Our society is going through a progressive replacement of printed-support documents with digital-support documents, and therefore, education is also going through this replacement. With the entry of computers and Internet in schools, teachers, publishers and policy-makers began to invest time, money and efforts in transforming classic worksheets, static pictures, linear books, etc., into non-linear websites, virtual learning environments, multimedia documents, etc.

Printed-support educational document for Physics Teaching

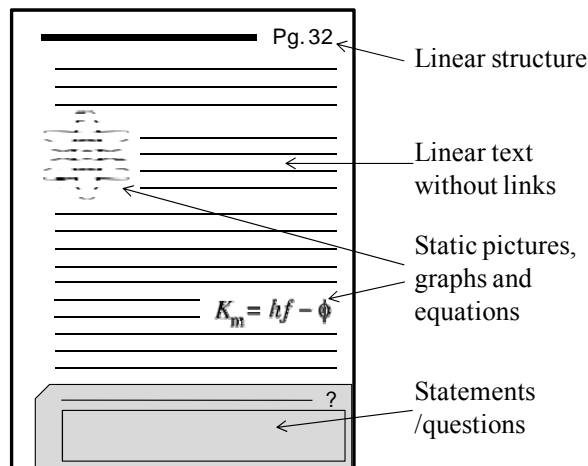


Figure 1

There are many qualitative differences between printed-support (figure 1) and digital-support materials (figure 2), such as the reading pattern, the interactivity that digital materials allow (links, control panels, simulation toolbars, etc.), and the possibility to develop multimedia communication. These differences lead us to talk about

“*hypermedia*”, a term that could seem a slightly old-fashioned word, but that is extremely useful to describe any digital-support document that includes the following three main features: hypertextuality (link-based non-linearity), interactivity and dynamic multimodality.

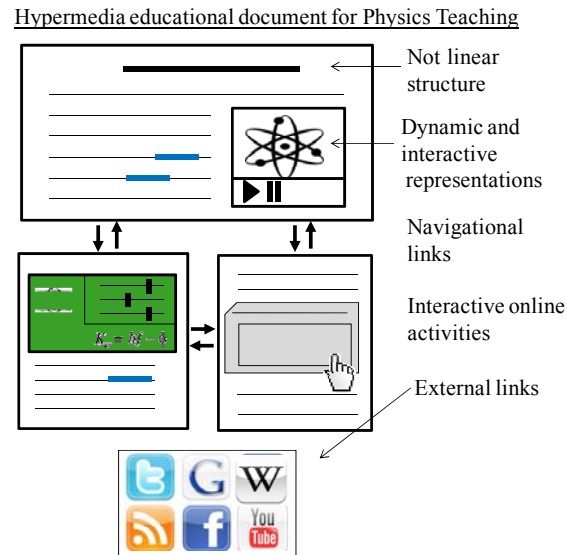


Figure 2

Those hypermedia documents have a great educational potential. They represent a chance for improving education, and thus, Physics education. Unfortunately, statements such as: “*with these materials students learn better because they can press buttons and see images in motion*” are rather frequent. That means that the benefits that the hypermedia materials are to bring to education are often taken for granted without any criteria, that is, without any theoretical framework. Therefore, it could seem that any change from printed support to digital support documents would improve *per se* the educational quality of those documents.

## 2. Rationale

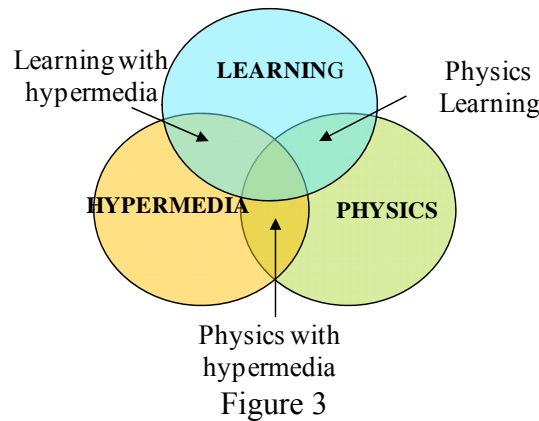
There is a need for some general guidelines about what transformations should be done in Physics educational printed texts to obtain good hypermedia learning materials. These general guidelines should avoid the development of arbitrary, useless or weak transformations, and it should be helpful to optimally target the design of efficient and well designed pedagogical materials. That is to say it would be useful to specify the main features hypermedia materials should have to enhance Physics teaching and learning.

Nevertheless, to assure the good educational quality of these hypermedia documents we should not only look at hypermedia potential, but also at other implicit theoretical frameworks. It is important to take into account how students learn and which are the main features of learning processes (deep learning, knowledge structure, multiple representations, etc.). This framework can play a crucial role in the development of an educational approach to hypermedia designs.

We also believe that general rules for transforming classic documents into hypermedia documents should include content’s specificities. In our case, those specificities come

from Physics and Physics Education: Physics' knowledge structure, Nature of Science, specific languages, etc. That might help us to define not only how to design good educational materials, but how to design good educational materials for Physics teaching.

In summary, we assume that different fields must be taken into account in order to determine the main features hypermedia materials should have to enhance Physics learning. These fields are "Hypermedia", "Learning" and "Physics", with their own intersections (figure 3).



So, we assume that the theoretical contribution of these three fields and their corresponding intersections can suggest many guidelines on the transformation process from classic to hypermedia documents (figure 4).

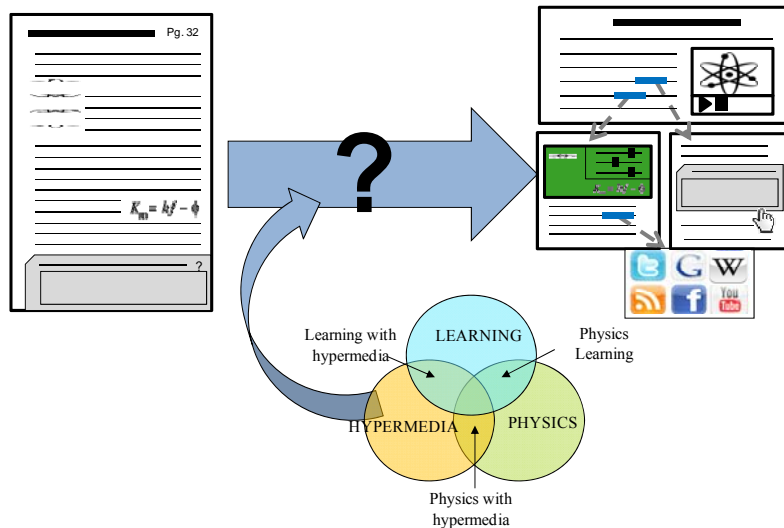


Figure 4

With this hypothesis, we aim at answering the following question: *Which transformations should be done in classic materials to obtain good hypermedia materials to enhance Physics learning?*

### 3. Methodological approach

This study is a theoretical discussion that was carried out throughout different processes. Firstly, we conducted a literature review of each of the fields shown in figure 3. Then, we conducted a theoretical research guided by the schema shown in figure 5, which includes some intermediate questions to deeply face the general question. Finally, we carried out an extensive review of hypermedia materials for Physics teaching available online, in order to identify examples of good practices, misuses or errors.

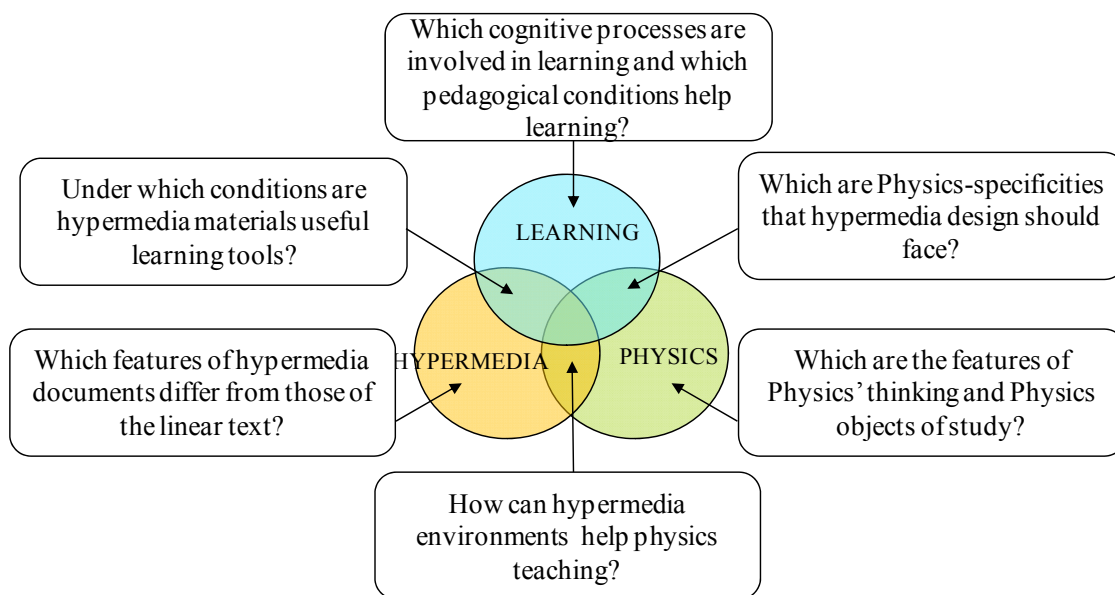


Figure 5

The result of these processes is a set of guidelines for transforming classic into hypermedia materials for Physics teaching and learning. These guidelines include recommendations and examples.

#### 4. Guidelines for transformation

We propose three simultaneous itineraries for transforming classic, linear and printed-support documents into hypermedia digital-support documents:

- From linear text into hypertext.
- From static pictures into multimedia files.
- From problem statements into embedded interactive applications.

##### 4.1. From linear text to hypertext

The transformation from linear text into hypertext implies a different pattern of reading and content organization. It is established that hypertexts differ from linear text as for the non-linear reading / navigation through links and nodes (pieces of information interconnected). They also differ in the role of links in the reading process (Puntambekar & Stylianou 2005).

We relate this hypertextual structure of a document with the learning process, where knowledge is organized and stored in learners' mind (Bransford et al. 1999). Learning processes involve the construction of a web of hierarchically structured knowledge, where pieces of knowledge should be richly interconnected (Biggs 1987) to assure a



good and flexible retrieval of knowledge (Spiro et al. 1988). Under this assumption, we recommend the following guidelines:

- Node-link structure should be highly hierarchical: While some unorganized node-link structures promote free association and exploration (figure 6), a hierarchical node-link structure is helpful for students' knowledge construction (Jonassen 2006).
- Navigation should be guided by meaningful links between parts: Students' awareness of the reasons for navigating from one node to another (de Jong & Van der Hulst 2002) can be helpful. Associating links with key questions is a good way to connect concepts and engage students through the hypertextual reading (figure 7).
- Only few links should be placed in each node: Some problems have been identified with links, such as disorientation and cognitive overload (Amadiou & Tricot 2005), and for this reason only few links have to be placed in each node, leaving readers to their own navigation but avoiding these problems (Troffer 2001).
- Node-link structure should be represented through a navigation map: It can enhance students' orientation through the document and the content comprehension (Salmerón et al. 2009).

In addition, if we take into account Physics features, those hypermedia documents should also include some specificity such as:

- Links should represent rigorous relationships from a conceptual point of view (Bramón 2000).
- Central ideas of Physics should be placed in high hierarchical order according to Physics content structure (Leonard et al. 1999).
- Node-links structure should promote a navigation pattern from the qualitative to the quantitative "equation-centred" analysis (Van Heuvelen 1991).

Different hypermedia documents available online are useful to discuss about these previous recommendations. For example, in figure 6 we can observe a node of the collaborative web Wikipedia. The location and features of the links (many links on blue-highlighted words) can be very useful for exploration, but they do not facilitate students' knowledge organization because there is no organized node-link structure. There are too many links and they are usually meaningless. Hypermedia documents for Physics education which contain this overload of links usually misuse hypertextual potential.

#### Simple harmonic oscillator

The simplest mechanical oscillating system is a **mass** attached to a **linear spring**  $\epsilon$  approximated on an air table or ice surface. The system is in an **equilibrium** state w the equilibrium, there is a net **restoring force** on the mass, tending to bring it back t equilibrium position, it has acquired **momentum** which keeps it moving beyond that opposite sense. If a constant **force** such as **gravity** is added to the system, the poi oscillation to occur is often referred to as the oscillatory **period**.

The specific **dynamics** of this spring-mass system are described mathematically b: motion is known as **simple harmonic motion**. In the spring-mass system, oscillatioi the mass has **kinetic energy** which is converted into **potential energy** stored in the : system illustrates some common features of oscillation, namely the existence of a grows stronger the further the system deviates from equilibrium.

The **harmonic oscillator** offers a model of many more complicated types of oscillati

Figure 6: Available at <http://wikipedia.org/>



Digital-support allows the use of a wide range of multimedia objects such as dynamic gif images, real videos, Flash animations, Java simulations and other dynamic embedded objects. It allows representing concepts and processes not only through static images but also through dynamic representations (i.e., images can move, appear, change, etc.) and through multimedia support (combining sound and view). This can enhance the use of more complex Multiple External Representations (Ainsworth 2006) in order to optimize the communication of Physics concepts, and it deal with the multiplicity and density of languages (text, pictures, graphs and equations) (Van Heuvelen 1991). In addition, dynamic representations are useful to reproduce both real (videos) and realistic phenomena (digital animated images), and they allow representing time-dependent processes at different velocities. Finally, these representations are useful to reproduce complex phenomena, non-perceptible phenomena (too big or too small systems) and dangerous or non-implementable phenomena (Trinidad et al. 2002).

For example, in figure 10 a MER can be observed, composed by a video of real magnets behaviour and an animation of magnets properties. This combination of different representations can be useful to bridge the gap between real and ideal world in Physics.

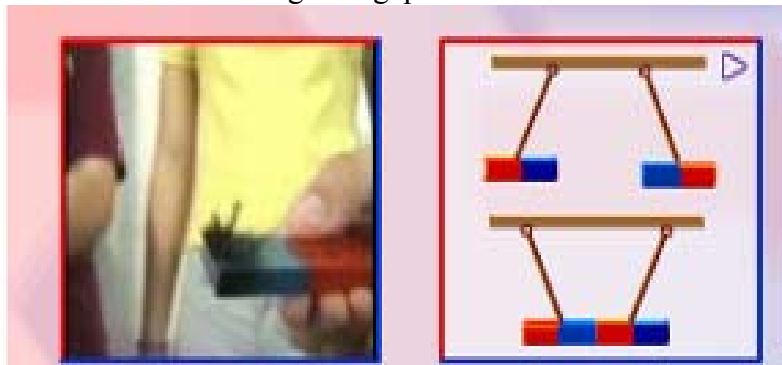


Figure 10: Picture available at:

<http://www.librosvivos.net/smtc/homeTC.asp?TemaClave=1073>

In the transformation of printed-support to digital-support representations, some warnings and limitations must be also taken into account:

- The design of representations should follow the guidelines that come from Multimedia Processing Theory (Mayer 1997, Austin 2009) such as spatial and temporal contiguity, coherence and simplicity and non-redundancy of codes (Cook 2006).
- Considering the simplicity principle, the multimedia codes should convey the idea to be highlighted (colour, sound, movement, etc), and use dynamic pictures uniquely when it gives some meaningful and necessary information. It is important to avoid the multimedia information classified as noisy, such as unnecessary movement, overly artistic pictures, music, etc.
- Representations should incorporate necessary scaffolding: Reading of images is not a trivial process and students sometimes wholly or partly mistake. So it is important to provide the necessary scaffolding when introducing educational representations (Ametller & Pintó 2002), such as captions, explanatory text (visual or auditory) or complementary images. It is also important to scaffold the translation between different languages (de Jong 2010).
- Extremely simplistic or incorrect representations should be avoided. They may lead to alternative conceptions or misconceptions.

Colour is one of the multimedia codes that can be dynamic in digital-support documents. Considering Kress & Van Leeuwen (2002), changing colour can contribute organizational communication, facing Physics' density of ideas and reducing cognitive overload (Mayer 2001). Different colours can be used to highlight different concepts, such as in figure 11, where an interactive picture shows different physical magnitudes using different colours. However, in figure 12 colours are intended to communicate an ideational linguistic function (i.e., colour=temperature), and it can lead to a conceptual mistake: if particles change their colour when they are heated, it means that temperature is a molecular property. It can be a pitfall for understanding the concept of temperature.

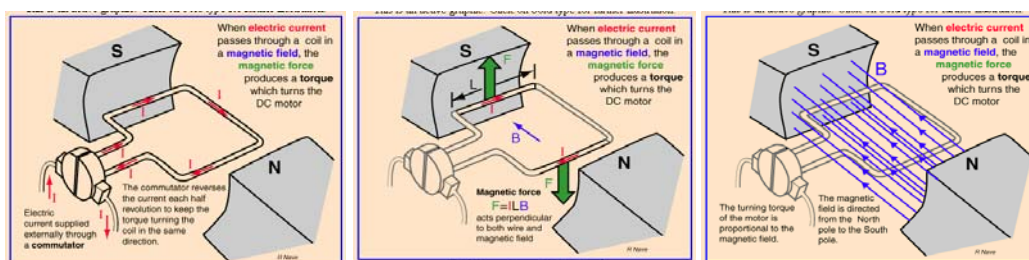


Figure 11: Available at <http://hyperphysics.phy-astr.gsu.edu/hbase/hframe.html>

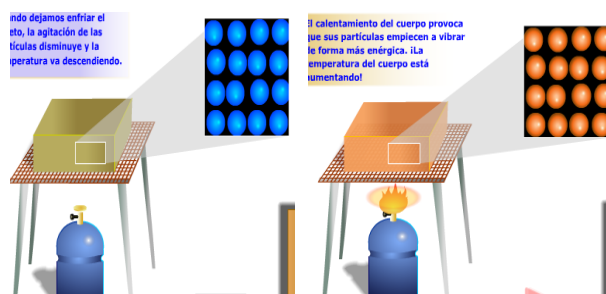


Figure 12: Available at <http://www.librosvivos.net/smtc/homeTC.asp?TemaClave=1062>

Finally, another issue that must be faced when transforming printed-support documents into digital-support documents is the differentiation between virtual realistic and real representations. Since Physics usually deal with ideal objects (Besson 2009), it is important to make explicit the nature of virtuality. The lack of distinction between real and realistic representations could lead us to think that virtual realistic representations can be used to demonstrate Physics principles or laws (Pintó & Gutiérrez 2004). Instead of making this error, it is important to help students to make clear distinction between real phenomena and simulations or animations.

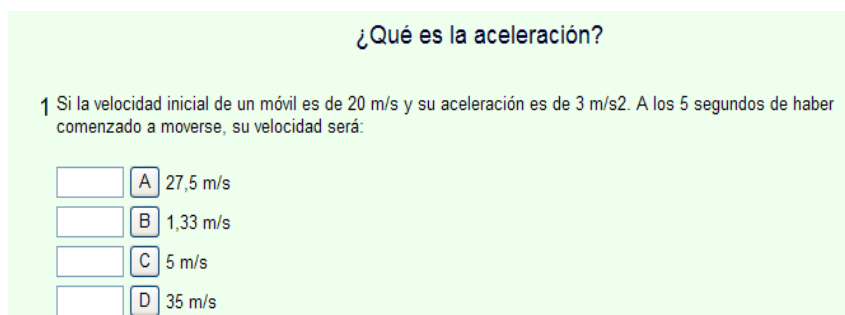
#### 4.3. From problem statements to interactive applications

Classic documents usually include statements of problems, questions, exercises, experiences, etc. Obviously, the pedagogical approach of these required activities strongly depends on the educational context. However, when transforming printed-support into digital-support, interactive applications can be embedded into documents, and it could seem that they become “modern” educational tools only because they are digital and interactive, even if they maintain a traditional educational approach (Pintó et al. 2010).

Many web pages and digital textbooks are filled with a wide range of educational applications. In these cases, what is more important is to understand the underlying pedagogical approach in each of these resources. In order to avoid a misuse of digital interfaces and to optimize the use of interactive applications as learning tools it is important to consider some specific conditions:

- A weak integration of interactive tools in hypermedia documents can cause that they are used as isolated games. It is important to carefully place these interactive tools in a learning sequence to support knowledge building (Henessy et al. 2007).
- Some interactive tools only promote “linear behaviourist assessment”, without helping students to understand why they are right or wrong (Faletič 2010). We should assure a rich variety of constructivist activities to promote cognitive challenge and high order skills, involving student thinking and doing (Pintó et al. 2010).
- The use of simulations does not assure any learning success, it depends on the scaffolding. When using simulations as an interactive tool, they are mostly effective when they are used as supplements, incorporate high-quality support structures, encourage students’ reflection and promote cognitive dissonance (Smetana et al. 2011).

An example of interactive application with a traditional approach is shown in figure 13. It is shown a problem statement that asks students to give the numeric result of the equation of the uniformly accelerated motion, and students receive a right/wrong assessment. Activities like this can be a useful tool for some specific learning activities (calculus training, developing memory, etc.), but if we only fill our hypermedia documents with these kind of activities, we will misuse the potential of interactive interfaces. Otherwise, in figure 14 it is shown an interactive application where students are asked to make a prediction. This application is integrated in a learning sequence, and the interactive interface can save students’ predictions in order to show them later and promote conceptual discussion.



¿Qué es la aceleración?

1 Si la velocidad inicial de un móvil es de 20 m/s y su aceleración es de 3 m/s<sup>2</sup>. A los 5 segundos de haber comenzado a moverse, su velocidad será:

A) 27,5 m/s

B) 1,33 m/s

C) 5 m/s

D) 35 m/s

Figure 13: Available at <http://perso.wanadoo.es/cpalacio/accelera2.htm>

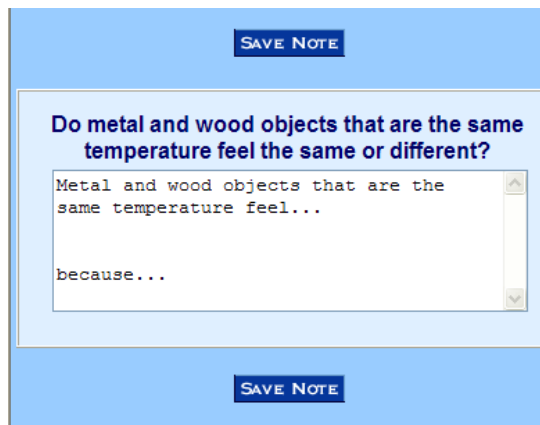


Figure 14: Available at <http://wise.berkeley.edu/>

## 5. Summary

Any transformation from printed-support to digital-support documents will not improve *per se* the educational quality of materials, and it is necessary to give some guidelines about how to carry out this process. We have identified a set of recommendations for these transformations, and we have grouped them into three main itineraries, which are related to hypertextuality, multimodality and interactivity, which occur in these digital-support documents.

## 6. Acknowledgements:

We want to acknowledge the AFINET project (SEJ2007-68113-C02-01) from the Spanish Government (MICINN).

## 7. References:

- Ainsworth, S. (2006). DeFT: A conceptual framework for considering learning with multiple representations. *Learning and Instruction*, 16(3), 183-198.
- Amadiou, F., & Tricot, A. (2005). Utilisation d'un hypermédia et apprentissage: deux activités concurrentes ou complémentaires? *Psychologie française*, 51, 5-23.
- Biggs, J. (1987). *Student Approaches to Learning and Studying*: Australian Council for Educational Research Ltd.
- Bramón, A. (2000). *Física per a tothom*. Barcelona: Servei de Publicacions de la UAB.
- Bransford, J., Brown, L., et al. (1999). *How people learn. Brain, Mind, Experience, and School*. Washington.
- Cook, M. P. (2006). Visual representations in science education: The influence of prior knowledge and cognitive load theory on instructional design principles. *Science Education*, 90(6), 1073-1091.
- de Jong, T., & Van der Hulst, A. (2002). The effects of graphical overviews on knowledge acquisition in hypertext. *Journal of Computer Assisted Learning*, 18, 219-231.
- Faletič, S. (2010). *Interactive e-learning content for physics*. Paper presented at the GIREP-ICPE-MPTL 2010, Reims.
- Hennessy, S., J., W., et al. (2007). Pedagogical approaches for technology-integrated science teaching. *Computers & Education*, 48, 137-152.
- Jonassen, D. (2006). On the Role of Concepts in Learning and Instructional Design. *Educational Technology Research and Development*, 54(2), 177-196.
- Kress, G., & van Leeuwen, T. (2002). Colour as a semiotic mode: notes for a grammar of colour. *Visual Communication*, 1(3), 343-368.
- Leonard, W. J., Gerace, W. J., et al. (1999). *Concept-based problem solving. Making concepts the language of physics*. Massachusetts: Department of Physcs & Astronomy and Marcel Dekker.
- Mayer, R. (1997). Multimedia Learning: Are we asking the right questions? *Educational Psychologist*, 32(1), 1-19.
- Mayer, R. (2001). *Multimedia Learning*. New York: Cambridge University Press.



- Pintó, R., & Gutierrez, R. (2004). Analysing Computer Scientific Simulations from a didactical point of view. In E. Mechlová (Ed.), *Teaching and Learning Physics in New contexts* (pp. 116-117). Ostrava, Checoslovaquia: University of Ostrava.
- Pintó, R., Couso, D., et al. (2010). An Inquiry-oriented approach for making the best use of ICT in the classroom. *eLearning Papers*, 20.
- Puntambekar, S., & Stylianou, A. (2005). Designing navigation support in hypertext systems based on navigation patterns. *Instructional Science*, 33, 451-481.
- Salmerón, L., Baccino, T., Cañas, J., Madrid, R., Fajardo, I. . (2009). Do graphical overviews facilitate or hinder comprehension in hypertext? *Computers & Education*, 53, 1308-1319.
- Smetana, L. K., & Bell, R. L. (2011). Computer Simulations to Support Science Instruction and Learning: A critical review of the literature. *International Journal of Science Education*, DOI: 10.1080/09500693.2011.605182.
- Trinidad, J., Filhais, C., Almeida, L. . (2002). Science learning in virtual environments: a descriptive study. *British Journal of Educational Technology*, 33(4), 471-488.
- Troffer, A. (2001). Writing Effectively Online: How to Compose Hypertext from <http://homepage.mac.com/alysson/htoc.html>
- Van Heuvelen, A. (1991). Learning to think like a physicist: A review of research-based instructional strategies. *Am. J. Phys.*, 59, 891-897.

## **Interactive e-learning content for physics**

Sergej Faletič

Faculty of mathematics and physics, University of Ljubljana  
sergej.faletic@fmf.uni-lj.si

Gorazd Planinšič

Faculty of mathematics and physics, University of Ljubljana  
gorazd.planinsic@fmf.uni-lj.si

Boris Horvat

Institute of mathematics, physics and mechanics, Ljubljana, Slovenia  
boris.horvat@fmf.uni-lj.si

### **Abstract**

Nowadays, internet and multimedia are important sources of information. Teaching processes have to adapt to these, but information-communication technology (ICT) also offers the chance to develop new teaching methods that are specifically designed to exploit the advantages of ICT over traditional methods, rather than trying to convert traditional methods to an ICT form.

Within the frame of a national project we are developing e-learning material to be used by high-school students (age 15-19). In developing the material we were aiming for more interactivity and contextual richness, by including examples from the "real world" and measurements of actual experiments, and for dynamic adaptation of the task's difficulty and pace to the users' achievements.

We developed interactive graphical tools and incorporated them into the problems. The feedback and the flow depend on answers, given on previous steps. After a failed attempt, the user is provided with hints to try again, or is led along a longer step-by-step route to the solution. Feedback on students' performance is provided to teachers, who can choose the detail of this information.

The material is comprised of blocks (individual, independent short tasks). A teacher can build a worksheet from these blocks, or build a task from scratch. The design of the content is entirely separated from the technical aspects, so the teacher can focus entirely on the content. Our team is developing an online platform where materials can be created and the required interactivity added. The material can also be exported as a SCORM package.

### **Introduction**

As part of a national project, funded by the Slovenian Ministry of Education and Sport and co-funded by the European Social Fund, we developed e-learning material that is freely available on the internet. Our main goal was to exploit the pedagogical value of the interactivity made possible by current internet technology, and to let the material be



designed by experts in the field of physics education, which included active secondary school teachers and university staff working in teacher training programs.

We started off by identifying, common flaws of most of the existing material which we summarised as:

- lack of interactivity,
- problems are too unidirectional in the sense that answers do not affect the flow,
- poor feedback to the user.

Next we decided on guidelines to follow in developing the new materials:

- as much interactivity as reasonable and possible,
- nonlinearity (as opposed to unidirectional approach) in the sense that answers from the user should influence the following steps,
- rich feedback to the users, with explanations and hints,
- include phenomena from "real life",
- provide detailed feedback to the teachers.

In the end, all the materials developed that passed our internal quality inspection were published on the portal [www.nauk.si](http://www.nauk.si). The portal is developed so that it allows further development, modification and use of the materials, which are published under the Creative Commons Attribution, non-profit, share alike licence, which means that everybody is free to use, distribute, modify and make derivative works of the materials, provided the original author is attributed, the purpose is non-profitable, and the resulting material is published under the same licence.

## **Method**

Our team consisted of two groups. One group consisted of the authors of the materials which were all experts in physics education. The other group consisted of information-communication technology (ICT) experts, who were responsible for the implementation of the ideas that came from the first group as well as for general structure of the ICT environment.

### *Design of the tasks*

The tasks were designed according to the before mentioned guidelines.

To achieve interactivity, the ICT team developed different tools, starting with the commonly used single choice, multiple choices, and numeric answers. In addition to these, tools have been developed to draw lines and vectors, and measure distances and angles. These can be used on pictures and videos. Also, a matching tool was developed that allows the user to match entities from one column to those from another. Among other tools there is also a star-map tool that allows the user to interactively use the star-map of the local sky.

To achieve nonlinearity, the problems were designed as a nonlinear tree, where depending on the response to specific question different feedbacks and different routes

are taken in the proceeding steps. In implementing this feedback loop, we adopted four guidelines:

- At the first failed attempt, the feedback provides hints depending on the user's responses.
- After two failed attempts, the program reveals the solution, briefly explaining the necessary reasoning to reach it. We found this two attempts guideline necessary to avoid frustration from getting stuck at one problem.
- In cases when the solution requires multiple steps, the user is guided through the necessary intermediate steps, applying the above guidelines at each step.
- In case of a correct answer, the program still provides a brief explanation, so that the user can double-check his reasoning.

The tasks are, where appropriate, derived from real life problems or real experiments.

#### *Underlying technology*

The ICT part was done by team NAUK (NAPredne Učne Kocke – Advanced learning blocks. The name is derived from the ambition to develop the materials as blocks (independent tasks) that can be combined together to form a more complex task according to the author's specific needs. The word "nauk" in Slovenian also means "teachings", with a somewhat archaic connotation and "moral of a story".

The portal is based on Ajax methods. It uses Hypertext mark-up language (HTML) and Cascading style sheets (CSS) for page design, Flash to provide interactivity, Extended mark-up language (XML) and Comma-separated values (CSV) for data storage and settings and a Wiki-like mark-up called fwiki for writing content, all bound together by JavaScript. All of the technologies used are supported by all contemporary major browsers, and installed by default on many computers, therefore very little, or no additional installations are required by the user.

The reason for introducing the fwiki syntax was to separate the content part from the underlying technology. We assumed that good authors do not necessarily have programming knowledge required to implement their ideas. Therefore, authors used the relatively simple fwiki syntax to write the content, decide on branching, insert required tools, etc. while all the underlying technology, (links, jumps, Flash tools, JavaScript) was provided by the NAUK team. The portal has an input field for the fwiki content and a parse button to translate the fwiki into HTML, adding all the required functionality.

The material produced can be exported as an HTML page with accompanying files, or as a SCORM package.

## **Results**

The portal [www.nauk.si](http://www.nauk.si) is open and accessible to the public. The materials are published under the before mentioned Creative Commons licence. Currently they are mostly in the

national language, but some of them have been translated to English to encourage internationalization.

Results are best shown through examples.

### *Car in a curve*

A car has been driven through a curve. The curve has been identified on satellite/aerial photos of the area. The scale of the image has also been found. A pendulum, hung from the rear-view mirror, has been photographed while driving through the curve. The task in the material, developed using this data, is to determine the speed of the car. The calculated result is then compared to the picture of the speed indicator, which has been initially blacked out.

The material provides the user with the picture of the curve and the tool to measure distances, which has been adjusted to the scale of the picture. The tool therefore already displays distances in actual real-life meters. A picture of the pendulum is also provided with the tool to measure angles. Care has been taken to assure that the picture preserves the angles of the real-life objects.

### Example

A car is driving on the curve shown on figure 1.  
A pendant is hanging from the rear-view mirror.  
The driver sees the view shown on figure 2.  
Determine the speed of the car.

$$v = \boxed{\phantom{000}} \frac{\text{m}}{\text{s}}$$

I would like to solve this step by step



Figure 1  
Bigger picture with tools



Figure 2  
Bigger picture with tools

Figure 1: An example of a task.

The user is asked to determine the speed of the car. This task requires several steps and the data has to be measured from the pictures.

If the user's first attempt is unsuccessful, since there are so many possibilities where the process could have gone wrong, the user is provided just with some general tips on problem solving, such as:

- Consider that moving through a curve at uniform speed is an accelerated motion, more precisely circular.
- Consider how the speed of the circulating object is related to its acceleration.
- Consider the relation between the motion of the pendulum and the car.
- Consider the forces on the pendulum in a circular motion and how they relate to its acceleration and its displacement angle.

The user is offered two choices: 1) to return and try to solve the problem again, or 2) to solve the problem step by step. After a second unsuccessful attempt the program leads the user through the step-by-step path.

The first step is to determine the radius of the curve. The user is given an explanation of why this is necessary, such as:

"To determine any quantity in a circular motion it will be most likely necessary to know the radius of the motion. Therefore, determine the radius of the curve."

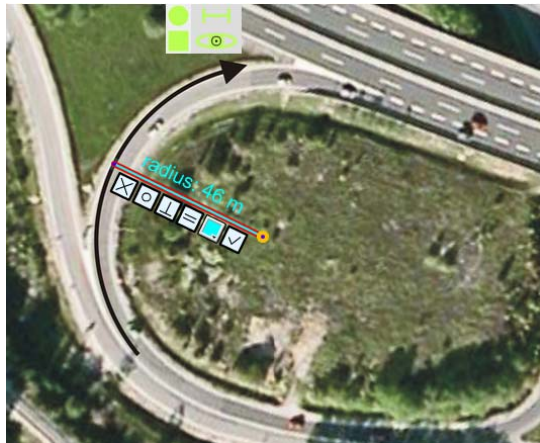


Figure 2: An example of the use of the "distance" tool.

This task may appear easy, but the centre of the curve is not marked on the picture, therefore the user is required to determine it himself. Failing to do so might yield a wrong result. In such case, the user is given a tip such as:

"Unfortunately, the answer is incorrect. Bear in mind that the centre must be at equal distance from all points on the curve. Use this to determine where the centre is and what the correct radius is."

In case the answer is still incorrect, the user is given the result and an explanation, according to the two attempts guideline. The feedback in this case could be such as:

"Unfortunately, the answer is incorrect for the second time.

The correct answer is  $(46 \pm 1)$  m.

To measure the radius of the curve, you must determine its centre. Use the measuring tool to find such a point and then measure the radius of the curve."

The text may be accompanied by pictures for clarification.

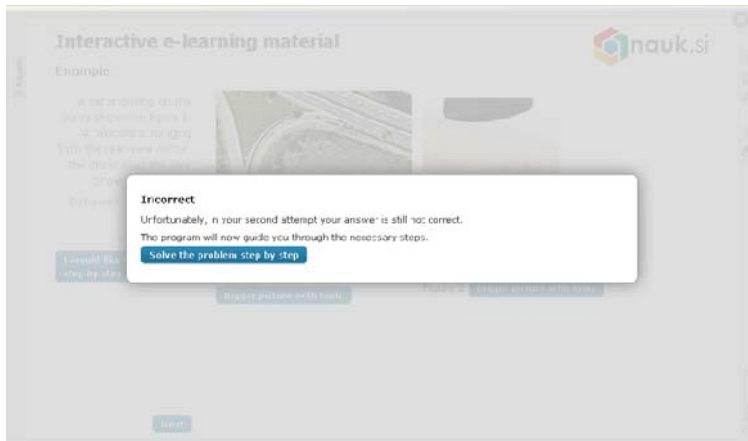


Figure 3: An example of a feedback popup.

Similar feedback is provided for every task in the process.

The next task is to draw the forces on the displaced pendulum. For this purpose a "vector" tool is provided. It enables the user to draw vectors on the picture and move them around. Features also include drawing a vector parallel to the chosen one and perpendicular to it. By moving the vectors around one can also visually construct a summation triangle or parallelogram.



Figure 4: An example of the use of the "vector" tool.

The next task is to determine the relation between the displacement angle of the pendulum and the resultant on it. The expression involves the tangent of the angle, so it becomes evident that for further calculation, it is necessary to measure the angle. This can be done by using the angle tool.



Figure 5: An example of the use of the "angle" tool.

The task continues through all necessary steps to arrive to the final answer: the speed of the car. Ideally, each step is explained so that the user is informed why it is necessary. Feedback is provided always by the same, before mentioned, guidelines.

A second example shows more tools.

#### *Bounce of a tennis ball*

A ball has been filmed running on a flat, horizontal surface, then bouncing off a force meter on one end and returning towards its original position. The ball's position is measured with an ultrasound sensor.

The task we will analyze here requires the user to determine the position-time dependence of the ball's motion.

The user is shown the movie and asked to predict the shape of the position-time dependence.

Watch the movie carefully. Determine the position-time dependence.



Figure 6: Movies or videos can also be included in the material and provide the source of data.

One way to do this is to use a multiple-choice question with different graphs as options. The choices should be such that they provide some insight into the possible misconceptions of the user. In Figure 7, for example, the bottom left graph is the correct answer, but the top right graph is the correct graph for velocity vs. time. Using such "meaningful" alternatives that address common difficulties, the statistics may provide valuable insight to the teacher on the level of knowledge of the users, but the feedback should include a warning to pay attention to the quantities on the axes, as being negligent is a very common source of errors.

From the graphs below choose the one that best represents the position-time dependence of the movement of the ball in the previous movie.

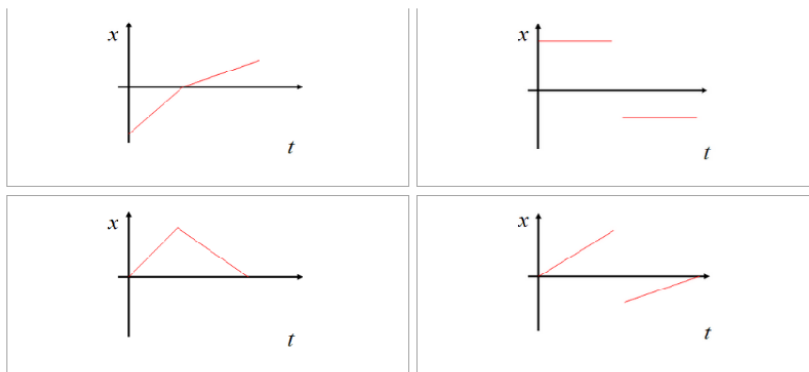


Figure 7: An example of a single choice question. A "meaningful" set of choices can provide insight in the reasoning and difficulties users have with the material.

Instead of giving the right answer we use the graph obtained by actually measuring the experiment while filming it. The program allows us to import a CSV file as a source of data for the graph, and provides a tool to read the data off the graph. Most programs dealing with tables can export data in CSV.

Observe the graph obtained by a measurement equipment

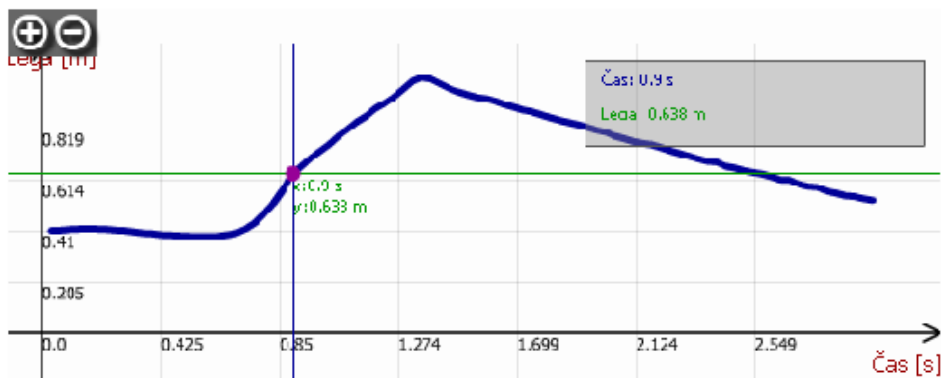


Figure 8: A graph of an actual measurement with the tool to read it.

This graph can then be used for subsequent tasks of determining the velocity before and after the collision, and from there the momentum. A similar graph of force vs. time is

later used to estimate the impulse of the force and compare it to the change in momentum.

At the moment 49 materials are published for the secondary school level of physics and many more for primary school level and other subjects, namely mathematics and informatics.

## Conclusion

### *Plans for the future*

The project ended on 30.8.2010. However, the NAUK team has decided to keep working on it and add some functionality that was suggested, but there was no time to implement it.

A functionality that was intended from the beginning but has not been implemented yet is the analysis of all drawn lines. This would enable the analysis of vectors, and the addition of tasks such as drawing vector fields and forces.

This would also enable the analysis of polygonal lines, called "polylines" that can be used to draw graphs or sketches thereof, such as drawing the prediction of the position-time dependence of a movement. At the moment "polylines" can be drawn, but not analysed.

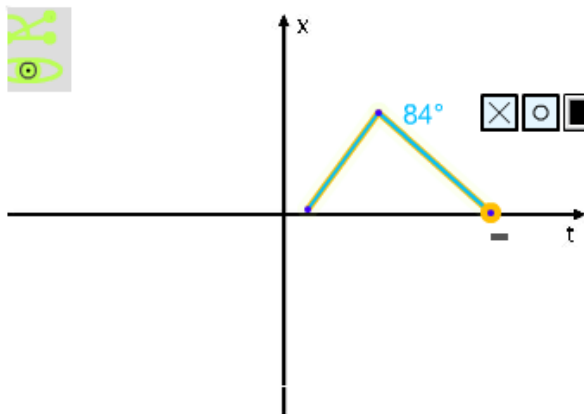


Figure 8: A polygonal line ("polyline").

In the future, the program should be able to log all the activities of a user during the problem solving procedure, and therefore provide as feedback to the teachers the exact steps the user performed while solving the problem. This should allow the teacher to identify similarities in the solving process of various students and determine what topics might need further discussion in class. A simple feedback in terms of achieved points, number of correct and incorrect answers is already available.

In terms of author input, a visual builder is planned, similar to popular programs for designing presentations, but it has not been implemented yet.



### Conclusion

We started from a standpoint that ICT is an independent medium that can be used to present physics content. Therefore, we did not attempt to adapt types of tasks found in other media for ICT environment, but rather identified what we believe to be specific advantages of ICT and focused on developing content specifically designed to best exploit these advantages.

During the process we were also aware of the limitations and disadvantages of ICT and tried to avoid content that would be better presented in other media or other settings.

As a result, we produced materials that are now freely available for use and modification under the Creative Commons Attribution, non-profit, share alike licence on [www.nauk.si](http://www.nauk.si). Some of the material has also been translated to English to encourage internationalization.

### References

- [1] Atkins, M.J. (1993). Theories of learning and multimedia applications: An overview. *Research in education*, 8(2), 251-71.
- [2] E-um portal, viewed 14.10.2010 from <http://www.e-um.si/>
- [3] E-gradiva, spletna učilnica portal, viewed 13.10.2010 from [http://www.e-cho.org/login\\_evsebine.asp](http://www.e-cho.org/login_evsebine.asp)
- [4] Farnsworth, R. E., (2001), *The Use of Flexible, Interactive, Situation-Focused Software for the E-Learning of Mathematics*, U.S.; Massachusetts; 2001.
- [5] Heuvelen A. van (1991). Learning to think like a physicist: A review of research-based instructional strategies. *Am. J. Phys.*, 59 (10), 891–897.
- [6] Heuvelen A. van (1991). Overview, case study Physics. *Am. J. Phys.*, 59, (10), 898–907.
- [7] How to write a good multiple-choice question, viewed 15.10.2010 from <http://hotpot.uvic.ca/howto/mcquestion.htm>
- [8] Jeong H.J. and Kim Y.S. (2009). E-Learning Content Design and Implementation based on Learners' Levels. *Polibits*, 39, 59-63.
- [9] Moore, M. G., (1996), Three types of interaction. *The American Journal of Distance Education*, 3(2). [http://www.ajde.com/Contents/vol3\\_2.htm#editorial](http://www.ajde.com/Contents/vol3_2.htm#editorial)
- [10] NAUK.si portal, viewed 14.10.2010 from <http://www.nauk.si>
- [11] Physlets, viewed 14.10.2010 from <http://webphysics.davidson.edu/applets/applets.html>
- [12] Pol, H.J. et al. (2009). How indirect supportive digital help during and after solving physics problems can improve problem-solving abilities. *Computers & Education*, 53 (1), 34-50.
- [13] Shaw R.S. (2010). A study of learning performance of e-learning materials design with knowledge maps. *Computers & Education*, 54, 253–264
- [14] Schoenfeld, A.H. (1992). Learning to think mathematically: problem solving, metacognition, and sense making in mathematics. In Grouws, D.A. *Handbook of research on mathematics teaching*. (224–270). McMillan Publishing, New York.
- [15] Sun, P. C., Cheng, H. K. (2007). The design of instructional multimedia in e-learning: A media richness theory-based approach. *Computers & Education*, 49 (3), 662–676.
- [16] Swan, K. (2003). Learning effectiveness: What the research tells us. In J. Boume & J.C. Moore (Eds) *Elements of quality online education*, Volume 4. Clin and Babson Colleges: Sloan Center for Online Education.
- [17] Writing Multiple-Choice Questions that Demand Critical Thinking, downloaded 15.10.2010 from <http://tep.uoregon.edu/resources/assessment/multiplechoicequestions/mc4critthink.html>
- [18] Zimmaro, D.M., Writing Good Multiple-Choice Exams, downloaded 15.10.2010 from <http://www.utexas.edu/academic/mec/research/pdf/writingmcexamshandout.pdf>

# Computer assisted kit-like modeling of physical systems

*Herman Mann*

*Czech Technical University in Prague*

*herman.j.mann@gmail.com*

## **Abstract**

The paper presents an approach to systematic conceptual modeling of multidisciplinary system behavior using diagrams portraying energy interactions between system parts. As the diagrams are isomorphic with the modeled real systems, they can be set up in a kit-like way based on mere inspection of the systems without any equation formulation. After submitting the diagrams in a graphical form to DYNAST software, the underlying equations are formulated automatically and solved for subsequent system simulation and animation.

## **Introduction**

The aim of physics is to explain and predict physical phenomena using their mathematical models expressing hypotheses based on observations in nature or in labs. Modeling became the key method used for solving scientific and engineering problems. It was also shown that modeling induces much greater changes in student wrong preconceptions about physics than conventional instruction [1]. There are thus no doubts that the primary objective of physics education should be developing student skills in systematic and efficient modeling. Yet the term ‘modeling’ is difficult to find in physics textbooks, models are somewhat misleadingly called there ‘laws’.

While the role of modeling in physics education is continuously emphasized, the views of it differ [2]. In this paper, modeling is considered as a process resulting in the mathematical description characterizing particular behavior of a real system. Different models may be chosen for the same system behavior depending on the time interval and required accuracy of modeling, size and time-rate of variable changes, etc. The Hook’s law, for example, is the model of spring elasticity limited to small, slow and short-time deviations of the spring elongation. Or the second Newton’s law models motion of solid bodies in the field of low velocities, etc. The wider is the region of the model validity, the more demanding is its development, parameter identification and verification. Students should be thus able to choose for the solved problem such model that is sufficiently accurate and simple as possible the same time.

## **Software tools**

### *Simulation software*

The modeling process results usually in a system of equations the solution of which allows for simulation or analysis of the modeled system behavior. The behavior can be characterized by responses of some system variables, or even by animated system pictures. This is illustrated by the flowchart shown in Fig. 1. A large number of applets simulating behavior of various physical systems is available on the web. Parameters of the simulated systems can be usually modified and, in some cases, the systems can be even controlled interactively. Observation of such ready-made applets can tell students *how* the systems behave. They do not explain them, however, *why* the systems behave in a certain way, and which physical phenomena determine their behavior. Neither they allow students to predict behavior of new systems. Even equations underlying the applet simulation, not only the way of their derivation, are mostly kept in secret.

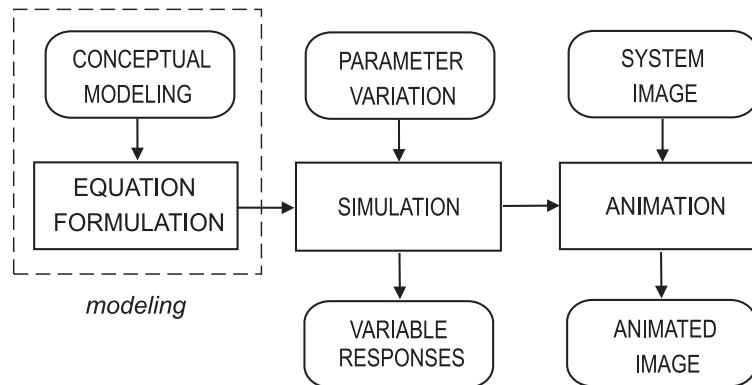


Figure 1: Flow of data in simulation software.

There is, of course, software available for simulation of user-specified physical systems. Some of these packages allow even development of animated simulation examples that can be published and re-run on the web [3]. In any case, before using the general-purpose simulation software, equations describing a system model must be usually derived by the pencil-and-paper method and then only they can be submitted to the computer. In some cases, the equations must be in addition converted into a block diagram, or even coded in a programming language and compiled before they can be solved. Neither this kind of software supports the modeling process as it was defined above.

As Fig. 1 indicates, modeling of every new problem requires thinking first in terms of the physical concept and then in terms of the corresponding mathematical description. Without question, this repeated transition between the physical and the mathematical thought is a difficult requirement even for engineering students [4]. Secondary-school students are not able to use such simulation packages at all because of their insufficient competency in mathematics.

### ***Computer-assisted modeling***

There exist, however, simulation software capable of not only solving equations describing a model, but also of formulating them automatically. Such software allows students to focus fully on the conceptual part of modeling without being distracted (and restricted) by the intricacies of equation formulation. This is particularly in line with a wider international trend that places more emphasis on conceptual physics rather than mathematical physics [5].

The software system DYNAST [6] implements all three rectangular blocks shown in Fig. 1. It allows for submitting conceptual models in the form of physical diagrams. As the configuration of these diagrams is isomorphic with that of the modeled real systems, the physical diagram construction can be based on mere inspection of the systems without any equation derivation. The diagrams can be set up on the computer screen in a graphical form using the DYNAST schematic editor. Users communicate with DYNAST installed either on their own computers or on a server using intuitive graphical dialogs. No learning of a textual simulation language, computer programming or compilation is needed. The server version supports students' collaboration and allows teachers to monitor and correct students' results via the computer network. DYNAST plots the resulting system responses in different forms, and exploits them for system animation. The DYNAST working environment supports also systematic documentation of solved problems.

## Multipole modeling

### Principles

Multipole models represent behavior of real systems evoked by the flow of energy or matter between the systems and their surroundings as well as between the system parts. Multipole modeling is based on the following approximating assumptions:

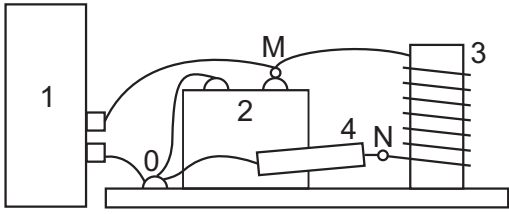
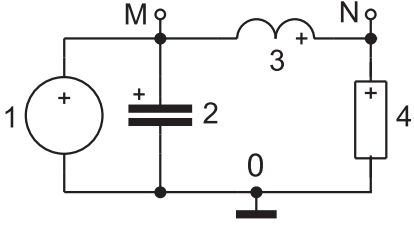
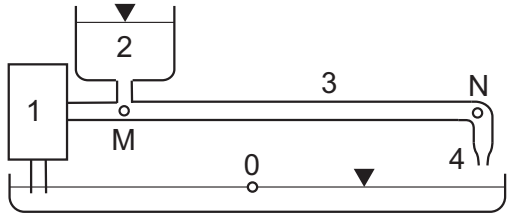
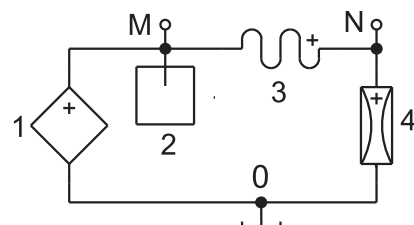
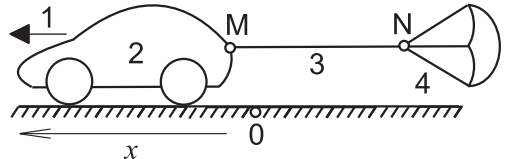
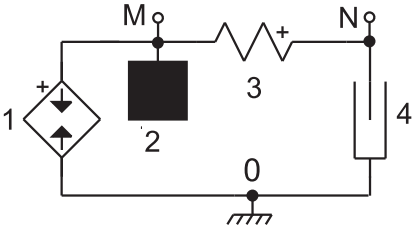
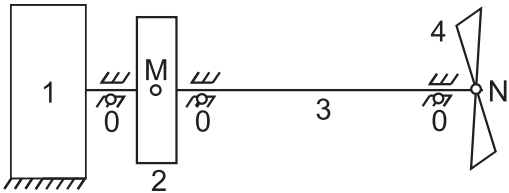
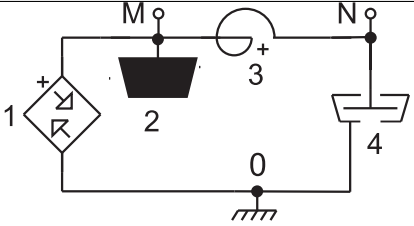
- The modeled real system can be imagined as decomposed into distinct system *parts* in such a way, that neither energy nor matter accumulates or changes its form in the space between the parts (parts can be imagined as separated by closed surfaces, fixed or movable ones).
- The flow of energy or matter to or from each system part takes place in a limited number of part *inlets* (formed by electrical terminals, fluid intakes, joints or other mechanical contacts, etc.).
- The adjacent inlets of different system parts form system *connections*.
- Flow of energy or matter between a part inlet and a system connection can be expressed as the product of a pair of complementary *power variables*.
- The system power variables obey postulates of continuity and compatibility.

Table 1: Pairs of power and energy variables.

Energy domain	Power variables		Energy variables	
	through $i(t)$	across $v(t)$	through $\int i dt$	across $\int v dt$
Electrical	electrical current [A]	electrical voltage [V]	electrical charge [C]	flux linkage [V s]
Magnetic	magnetic flow rate [Wb s <sup>-1</sup> ]	magnetic voltage [A]	magnetic flow [Wb]	not known
Fluid or acoustic	volume flow [m <sup>3</sup> s <sup>-1</sup> ]	pressure [N m <sup>-2</sup> ]	volume [m <sup>3</sup> ]	pressure impulse [N s m <sup>-2</sup> ]
Mechanical rectilinear	force [N]	velocity [m s <sup>-1</sup> ]	momentum [N s]	displacement [m]
Mechanical rotational	moment of force (torque) [N m]	angular velocity [rad s <sup>-1</sup> ]	angular momentum [N m s]	angular displacement [rad]

Table 1 gives examples of some pairs of *power variables*. Through and across variables differ in the way of their direct measurement. To measure the *through variable* between a part inlet and a system connection, the part must be disconnected from the connection and then re-connected to it via a measuring instrument. *Across variables* are measured between distinct system connections without any disconnection. Table 1 shows also examples of *energy variables*, i.e. power variables integrated over time.

Table 2: Simple examples of physical diagrams.

REAL SYSTEMS		SYSTEM MODELS
		
<i>No.</i>	<i>Real parts</i>	<i>Physical elements</i>
1	electrical battery	source of electrical voltage
2	electrical condenser	electrical capacitor
3	coil of wire	electrical inductor
4	electrical resistor	electrical resistor
		
<i>No.</i>	<i>Real parts</i>	<i>Physical elements</i>
1	motor-driven pump	source of volume flow-rate
2	open tank	fluid capacitor
3	long pipe	fluid inductor
4	tap faucet	fluid resistor
		
<i>No.</i>	<i>Real parts</i>	<i>Physical elements</i>
1	car engine	source of force
2	car body	inertor
3	long rope	spring
4	parachute	damper
		
<i>No.</i>	<i>Real parts</i>	<i>Physical elements</i>
1	motor	source of angular velocity
2	flywheel	rotational inertor
3	long shaft	torsional spring
4	ventilator propeller	rotational damper

### Physical diagrams

Physical diagrams are graphical representations of multipole models. Simple examples of these are shown in Table 2. Behavior of each of the system parts is characterized in the related diagram by a graphical symbol. There are three system connections in each of the systems denoted by characters M, N and O. Each of the connections is represented in the diagram by a *node*. Special symbols are attached to nodes denoted by O to indicate that these are considered as *reference nodes*. Each node has a value equal to its across variable with respect to the reference node. Thus the across variable of the reference node is always zero (like voltage of the electrical ground, the open-air pressure, velocity of the reference frame, etc.).

Part inlets are represented by *poles* denoted as short line segments sticking out of the part-model symbols. Poles are interconnected with nodes by *links*, i.e. by lines identifying interactions between part inlets and system connections. Each link is thus associated with a pair of power variables that can propagate along it in both directions.


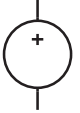




Table 3: Physical elements dissipating or accumulating energy.

NONMECHANICAL	CONDUCTOR	RESISTOR	CAPACITOR	INDUCTOR
Electrical				
Magnetic				not known
Fluid or acoustic				
MECHANICAL	damper		inertor	spring
Rectilinear		not used		
Rotational		not used		
CONSTITUTIVE RELATION	$i = p \cdot v$	$v = p \cdot i$	$i = p \frac{dv}{dt}$	$v = p \frac{di}{dt}$

Table 3 presents graphical symbols used in DYNAST for *physical elements* modeling either energy dissipation or accumulation in system parts. Each of the elements can be considered as a 'pure' model of a single physical phenomenon taking place in a system part with two energy entries. Though all symbols in Table 3 represent twopole models, there is only one line segment sticking out of the symbols for fluid and acoustic capacitors as well as for rectilinear and rotational inertors. As one of their poles must be always connected to the reference node, the connection is done automatically by DYNAST.

Each physical element is associated with the *element through variable*  $i(t)$  and the *element across variable*  $v(t)$ . *Constitutive relations* between these variables specific for different physical elements are given in the last row of Table 3. In the case of *ideal elements* parameter  $p$  is constant. DYNAST allows, however, to specify  $p$  also as a function of some variables of the same or some other element, of time, or of an ambient parameter like temperature, for example.

Table 4: Sources of through or across variables.

Generic	through-variable source		across-variable source	
Mechanical rectilinear	source of force		source of velocity	
Mechanical rotational	source of torque		source of angular velocity	
Constitutive relation	$i = p$		$v = p$	

Two additional physical elements – sources of through and across variables – are indispensable in multipole models. Their symbols are shown in Table 4. The sources usually represent energy reservoirs large enough relative to the amount of energy they supply to the system or absorb from it without undergoing any change either in their across or through variable.

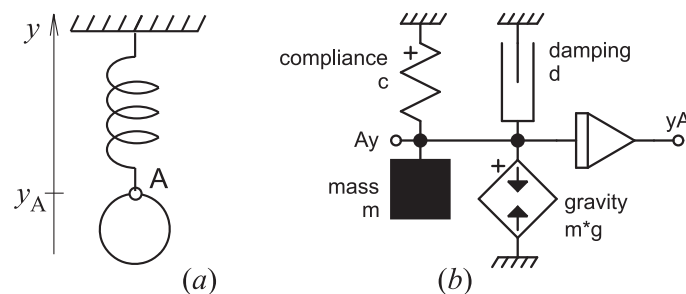


Figure 2: (a) Weight hanging on a spring, (b) multipole model.

### Composed models and multipoles

Each of the system parts in Table 2 is modeled by a physical element representing its dominant physical effect only. More realistic models of system parts can be composed from several elements. Fig. 2 shows a weight hanging on a spring and its model. Node  $A_y$  in the model corresponds to geometric point A representing the vertical motion of the weight. Besides the inductor, the model of the weight behavior is composed also from the source of the gravitational force. The spring model respects not only compliance, but also the damping effect of the spring material. The triangular symbol stands in the diagram for a block computing vertical position  $y_A$  of point A by integrating velocity of node  $A_y$ . This indicates, that the multipole diagrams can

be combined with blocks. For example, a controlled plant can be modeled by multipoles, while the configuration of its control might be represented by blocks.

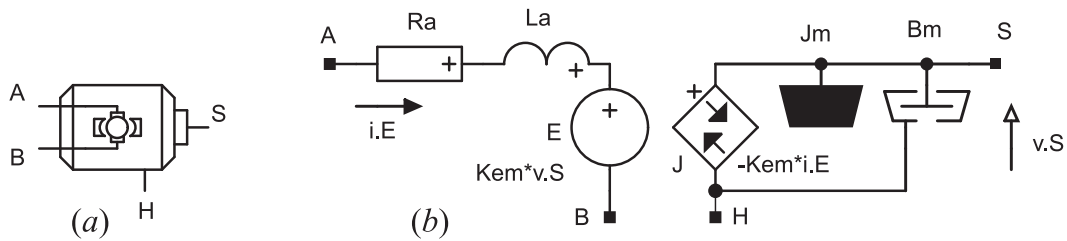


Figure 3: (a) Multipole model of a DC motor, (b) its composition from physical elements.

Model of a system part composed from physical elements and combined with blocks or equations can be encapsulated in a multipole model of the part. It can be then stored in the computer memory and reused by DYNAST later with some of its parameters modified. An example of such model is shown in Fig. 3, where  $K_{em}$  denotes the electro-mechanical constant. This example demonstrates also the way in which couples of controlled sources can be exploited to models various kinds of transducers between different energy domains.

### *Postulates of continuity and compatibility*

The automated formulation of equations for a physical diagram submitted to DYNAST is based on the postulates of continuity and compatibility. Interpretation of these postulates in terms of traditional physical laws is given in Table 5.

Table 5: Postulates of continuity and compatibility.

DOMAIN	POSTULATE OF CONTINUITY	POSTULATE OF COMPATIBILITY
electrical	Kirchhoff's current law	Kirchhoff's voltage law
magnetic	continuity of magnetic flux	Ampere's circuital law
fluid	principle of mass conservation	principle of pressure composition
mechanical	dynamic equilibrium of forces	principle of motion composition

According to the *postulate of continuity*

$$\sum_k i_k = 0$$

where  $i_k$ ,  $k = 1, 2, \dots$  are through variables entering a node.

According to the *postulate of compatibility*

$$v_{jk} = v_j - v_k$$

where  $v_j$  and  $v_k$  are node across variables of nodes  $j$  and  $k$ , respectively, and  $v_{jk}$  is the across variable between these nodes.



## Conclusions

The first versions of the DYNAST software implementing the outlined modeling methodology were developed by the author and his students thirty years ago. Since then, it has been used both as an engineering tool in the industry as well as an educational tool in engineering schools. With the invitation to participate in the EU-supported project [7] the opportunity arose for testing it as a tool for enhancing physics in one Czech and two German high schools.

High-school teachers of physics involved in the project were rather sceptical about its outcomes initially. Their main objections were: (1) the proposed modeling methodology is too difficult for students to understand, (2) students will need a special staff to assist them with using computers, (3) there is no spare time for including additional topics in the physics curriculum.

Some of the teachers stopped repeating the first objection only after all of their students were happily using multipole modeling to solve their problems. Their bias against the new approach just confirmed the old saying that ‘teachers tend to teach in the way they were taught’. Neither the second objection proved true. Students were eager to help each other, and most of them showed interest to use DYNAST even in their free time on their own computers.

Fortunately, multipole modeling is based on a surprisingly few fundamental concepts which can be applied to a wide range of problems. Curriculum with such modeling properly integrated avoids unnecessary duplication. The paper demonstrated a unified approach to modeling phenomena from several energy domains. Another example of time saving comes from mechanics: statics, kinematics and kinetics – taught separately in traditional curricula – can be treated just as special cases of dynamics.

Such a concise approach gives students more cohesive view of physics and allows introducing more advanced activities into the study program. Simulation experiments using software capable of automated equation formulation gave students the opportunity to study behavior of much more practical and interesting problems. Students appreciated especially the opportunity to solve simplified design problems solved in the local industry.

This is not to say, however, that students should not learn how to formulate equations (though DYNAST can help there too by solving equations derived by students and then by comparing their results with those obtained automatically.) The influence of automated equation formulation on education can be compared with that of pocket calculators: they increased the students’ problem-solving efficiency, but did not decrease the importance of learning arithmetics.

## References

- [1] D. Hestenes: Notes for a modeling theory of science, cognition and instruction. *Proc. GIREP Conf.* 2006, Amsterdam, 34-65.
- [2] P. Lijnse: Models of/for teaching modeling. *Proc. GIREP Conf.* 2006, Amsterdam, 20-33.
- [3] W. Christian, F. Esquembre: Modeling physics with Easy Java Simulations. *The Physics Teacher*, 45(8), 475-480.
- [4] J.L. Merriam, L.G. Kraige: *Engineering Mechanics - Dynamics*. Wiley 1998, 4th ed., 10.
- [5] The subject of Physics from an international perspective. *The Danish Evaluation Institute*, 2009, <http://english.eva.dk/>
- [6] Different forms of access to DYNAST software and its documentation as well as examples re-solvable across the Internet are at <http://virtual.cvut.cz/dyn/examples>.
- [7] POPBL - School Science Teaching by Project Orientation - Improving the Transition to University and Labor Market. SAS6-CT-2006-042936-POPBL.

## **Interactive online resources to teach Physics: quality criteria and teachers' expectations**

Jorge Andrade Silva<sup>(1)</sup>, José Paulo Cravino<sup>(2)(3)</sup>, Norberto Jorge Gonçalves<sup>(2)(4)</sup>

<sup>(1)</sup> Henrique Medina Secondary School, Esposende, Portugal

<sup>(2)</sup> Physics Department, School of Sciences and Technology, University of Trás-os-Montes e Alto Douro, Vila Real, Portugal

<sup>(3)</sup> Research Centre for Didactics and Technology in Teacher Education, Univ. of Aveiro, Aveiro, Portugal

<sup>(4)</sup> GCEP-Center of Physics, Univ. of Minho, Braga, Portugal

E-mail: [jorge.silva@ymail.com](mailto:jorge.silva@ymail.com), [jcravino@utad.pt](mailto:jcravino@utad.pt), [njg@utad.pt](mailto:njg@utad.pt)

### **Abstract**

Current reforms in Physics education call for the integration of digital technologies into teaching, advocating that students learn Physics content and processes through technology (Dani and Koenig, 2008) and the Internet offers a rich source of potential learning resources (Richards, 2005). However, for most Physics teachers, there is a huge difficulty to select valuable resources and to understand how their pedagogical potential in formative situations can be optimized.

To address this gap, we propose the development of a feasible list of criteria to evaluate interactive online resources, based on four contributions dealing with interactive materials evaluation from the perspective of their use by teachers (CEIMSC<sup>1</sup>, MERLOT<sup>2</sup>, MPTL<sup>3</sup> and SACAUSEF<sup>4</sup>). We also show the preliminary results of a survey of a sample of Portuguese Physics teachers, concerning the way they find, use, and evaluate the quality of interactive online resources. The proposed list of criteria for the evaluation of interactive online resources is compared with the results from this survey to find if they match the teachers' needs and perceptions about this issue.

### **Interactive online resources to teach Physics**

In the universe of educational resources for Physics in digital format, we classify an interactive online resource for the teaching of Physics as a software application available on the Internet that promotes and facilitates interaction with the user, through software specifically designed and intended to be used in educational situations in Physics (Ramos 1998).

A search on any search engine on the Internet reveals the existence of a large number of interactive resources (Clinch & Richards, 2002). However, this abundance of resources has not materialized in educational use in classrooms, despite continuous growth of computer facilities in schools for their use (Eteokleous, 2008) and the existence of a lot of resources to teach Physics in the Internet (Richards, 2005).

---

<sup>1</sup> <http://www.ceismc.gatech.edu>

<sup>2</sup> <http://www.merlot.org>

<sup>3</sup> <http://www.mptl.eu>

<sup>4</sup> <http://www.crie.min-edu.pt/index.php?section=92>

Despite an often instinctive skepticism, many teachers consider the Internet a rich source of learning resources, specifically interactive ones, which present different levels of abstraction, help students gain a better understanding (Altherr *et al.*, 2004) and allows them to become actively involved in learning (Renkl & Atkinson, 2007).

However, some teachers simply are unaware of their existence. To others, there is a huge difficulty to select valuable resources and to understand how their pedagogical potential in formative situations can be optimized. In fact, one cannot expect most teachers to effectively find, evaluate, and use these resources, in addition to their already high workload (Mathelitsch, 2008).

It is against this background that the criteria for the validation of resources appear as a decisive step to promote its use in order to equip teachers with tools reliable and easily accessible. The overcome of this barrier will allow a better judgment and critical evaluation of digital resources in the target ground for which they were created for in different contexts (Bratina *et al.*, 2002) and learning environments. This step seems crucial to the development of the existent and new resources.

### **Interactive online resource's evaluation**

The evaluation of the quality of interactive online resources established itself as a central issue because there remains doubt about the educational value of many products available that can be used in school settings and for educational purposes (Dani & Koenig, 2008). In this sense, Costa (2005) argues that the assessment should highlight the need to guide teachers in knowledge and possible uses of resources that are available to them, providing effective integration into the curriculum, with pedagogical sense and set the specific educational processes.

Le & Le (2007) report that there is a paucity of systematic studies on the educational use and validation of interactive online resources and those that exist are constructed from the perspective of evaluators, not the users. They advocate that the use of educational resources reflects the view of the teacher on how the student is supposed to learn and not on what impact the action may (or not) come to have on student learning.

Mathelitsch (2008) argues that the evaluation of interactive online resources to teach Physics must be framed in a more ambitious process, including the selection of resources, the inclusion in a database and the evaluation using criteria of quality consolidated and standardized.

#### Existing criteria lists

The interactive online resources evaluation is usually supported by grids and scales previously developed and produced in accordance with the points that are critical to its viability teaching. For example, the United States in 1994, the CEISMC (Center for Education Integrating Science, Mathematics and Computing) has established an evaluation grid of virtual educational resources (available at [http://www.ceismc.gatech.edu/MM\\_Tools/ERC.html](http://www.ceismc.gatech.edu/MM_Tools/ERC.html)), which incorporates the evaluator's opinion on issues related to instructional design, the aesthetic design, and functionality of the program, in a scale of 10 items.

The Portuguese system of evaluation and certification - SACAUSEF - adopted a descriptive evaluation of mixed grid, which differentiate five areas: technical, content, pedagogy, language and values and attitudes. The evaluator, who is a specialized teacher to evaluate

educational resources of his curricular area, is also responsible for implementing an evaluation with students in the context of the classroom.

The MERLOT project set for resource assessment a list of criteria divided into three areas: content quality, effectiveness as a Teaching-Learning Tool and ease of use. It also specifies with that grid, available in <http://physics.merlot.org/PeerReviewCriteria.html>, a set of criteria to be assessed by the reviewers in each field of analysis.

In an article by Altherr et al. (2004) is made the state of art of multimedia resources for teaching physics, particularly in phases of research, selection and evaluation, arising from the work of the project team MPTL. This publication sets a list of criteria used to evaluate the quality of the resources embodied in the criteria applied to two practical examples. This article constitutes one of the explicitly cases of scientific publications found in the phase of research that relate specifically to how the materials to support physics classes available on the Internet are searched, selected and evaluated by teachers. The list proposed by the MPTL group (Altherr et al., 2004) establishes three criteria areas: motivation, content and method. The first area focuses on the use of empathy with the user and ease of navigation, the second in its scientific correctness and the third with the applicability of the resource and its suitability for teaching in pedagogical intended.

The evaluation domains and the specific criteria of the aforementioned institutions are shown in Table 1.

CEIMSC (USA)	MERLOT (USA/CAN)	SACAUSEF (PT)	MPTL (EU)
<b>Evaluation domains</b>			
1. Instructional design 2. Cosmetic design 3. Program functionality	1. Quality of content 2. Effectiveness as a Teaching-Learning Tool 3. Ease of use	1. Technical 2. Content 3. Pedagogical 4. Linguistic 5. Values	1. Motivation 2. Content 3. Method
<b>Specific criteria</b>			
1.1. This IMM provides learners with a clear knowledge of the program objectives. 1.2. The instructional interactions in this IMM are appropriate for the objectives. 1.3. The instructional design of this IMM is based on sound learning theory and principles. 1.4. The feedback in this IMM is clear. 1.5. The pace of this IMM is appropriate. 1.6. The difficulty level of this IMM is appropriate.  2.1. The screen design of this IMM follows sound principles. 2.2. Color is appropriately used in this IMM. 2.3. The screen displays are easy to understand.  3.1. This IMM operated flawlessly.	1.1. Does the material present valid (correct) concepts, models, and results? 1.2. Does the material present important physics concepts or models? 1.3. Does the material help develop conceptual understanding of physics? 1.4. Does the material make effective use of graphics and multimedia? 1.5. Is the material flexible?  2.1. Does the material relate to the learner's knowledge and needs? 2.2. Does the material promote knowledge development? 2.3. Does the material provide a quality learning experience? 2.4. Does the material provide learners with quality feedback?  3.1. Does the material operate in an understandable manner? 3.2. Is the general layout of the material consistent and intuitive? 3.3. Does the material provide effective feedback? 3.4. Is the material documented and does it have useful instructions?	1.1. Software compatibility 1.2. Design 1.3. Existence of useful instructions 1.4. Available functionalities 1.5. Users help  2.1. Scientific correctness 2.2. Matching to target group 2.3. Content appropriate to learner's needs.  3.1. Appropriation to curricular program goals 3.2. Possibility of curriculum integration 3.3. Respect for different learning rhythms  4.1. Grammatical correction 4.2. Language clearness  5.1. Absence of stereotypes and preconceptions 5.2. Promotion of male and female equality 5.3. Absence of violence's incitation 5.4. Nature and environment friendliness	1.1. User-friendliness 1.2. Attractiveness 1.3. Clear description of purpose and work assignment  2.1. Relevance 2.2. Scope 2.3. Correctness  3.1. Flexibility 3.2. Matching to target group 3.3. Realization 3.4. Documentation

**Table 1:** Lists of quality criteria of educational resources.

Despite of using different terminology, we can see in a deeper analysis that there is a common trunk between the criteria adopted by each entity. The content area appears explicitly in the four lists, verifying that they share also the specific criteria: scientific correctness and appropriateness to the theme to which they relate. The technical field is also transverse to all lists, even under the guise of different terminology: "Ease of use" in MERLOT and "Motivation" in MPTL; CEIMSC on the criteria to be spread over the fields "Design" and "Functionality ". In all lists pedagogical criteria are set, though there are differences in both the name adopted as the relative weight. In this regard it is noted that the criteria listed in CEIMSC, the oldest of four, have its own domain and part of the content area, and that the list of MPTL disperse the fields "Motivation" and "Method". The list adopted by SACAUSEF incorporates the areas of "Language" and "Values and attitudes" to the three already mentioned. The criteria for these areas do not appear explicitly in the other lists, although that could fit the part of the content.

Table 2 shows that the criteria of the four lists referenced can be framed in the areas of content, pedagogical and technical.

CEIMSC (USA)	MERLOT (USA/CAN)	SACAUSEF (PT)	MPTL (EU)
<b>Content domain</b>			
1.1. This IMM provides learners with a clear knowledge of the program objectives. 1.6. The difficulty level of this IMM is appropriate. 2.3. The screen displays are easy to understand.	1.1. Does the material present valid (correct) concepts, models, and results? 1.2. Does the material present important physics concepts or models? 1.3. Does the material help develop conceptual understanding of physics? 1.4. Does the material make effective use of graphics and multimedia? 1.5. Is the material flexible?	2.1. Scientific correctness 2.2. Matching to target group 2.3. Content appropriate to learner's needs. 4.1. Grammatical correction 4.2. Language clearness 5.1. Absence of stereotypes and preconceptions 5.2. Promotion of male and female equality 5.3. Absence of violence's incitation	1.3. Clear description of purpose and work assignment 2.1. Relevance 2.2. Scope 2.3. Correctness
<b>Pedagogical domain</b>			
1.2. The instructional interactions in this IMM are appropriate for the objectives. 1.3. The instructional design of this IMM is based on sound learning theory and principles. 1.4. The feedback in this IMM is clear.	2.1. Does the material relate to the learner's knowledge and needs? 2.2. Does the material promote knowledge development? 2.3. Does the material provide a quality learning experience? 2.4. Does the material provide learners with quality feedback?	3.1. Appropriation to curricular program goals 3.2. Possibility of curriculum integration 3.3. Respect for different learning rhythms 5.4. Nature and environment friendliness	3.1. Flexibility 3.2. Matching to target group 3.3. Realization 3.4. Documentation
<b>Technical domain</b>			
1.5. The pace of this IMM is appropriate. 2.1. The screen design of this IMM follows sound principles. 2.2. Color is appropriately used in this IMM. 3.1. This IMM operated flawlessly.	3.1. Does the material operate in an understandable manner? 3.2. Is the general layout of the material consistent and intuitive? 3.3. Does the material provide effective feedback? 3.4. Is the material documented and does it have useful instructions?	1.1. Software compatibility 1.2. Design 1.3. Existence of useful instructions 1.4. Available functionalities 1.5. Users help	1.1. User-friendliness 1.2. Attractiveness

**Table 2:** Lists of quality criteria separated by content, pedagogical and technical domains.

The compatibility between the lists is supported by the joint evaluation of resources by projects MERLOT and MPTL, each one using its own list. Mathelitsch (2008) states that this process involves two stages: a preliminary assessment of resources, made by one entity responsible for making triage of the resources to undergo a full evaluation, and a second phase, in which resources validated in the Preliminary undergo an independent evaluation by each entity, reaching at the end a final compromise between the results of each evaluator.

Geissinger (1997) argues in this respect that organizations that deal with these resources should work towards the establishment of standardized criteria and terminology.

## Proposal for quality criteria list

In pursuit of uniformity of criteria and terminology used for the evaluation of educational resources available on the Internet and given the specificity of the materials adopted for study in this work (interactive resources in the field of physics), we propose the adoption of a list of criteria (see Table 3 ).

RESOURCE'S EVALUATION					
<b>A. Content</b>					
	NA	1	2	3	4
A1: Scientific correction					
A2: Clarity in the use of physics concepts					
A3: Appropriateness of language and linguistic correctness					
A4: Absence of prejudices and stereotypes					
<b>B. Pedagogical effectiveness</b>					
	NA	1	2	3	4
B1: Integration into the curriculum					
B2: Suitability to target audience					
B3: Suitability for the existence of guidelines for didactic exploration					
B4: Links to other related resources					
B5: Inclusion of formative assessment tools					
B6: Sufficiency of the metadata					
<b>C. User friendliness</b>					
	NA	1	2	3	4
C1: Ease of navigation					
C2: Features available					
Global appreciation:					
<b>Legend:</b> NA=Not applicable, 1=Strongly disagree, 2=Disagree, 3=Agree, 4=Strongly agree					

**Table 3:** Proposed list of quality criteria.

The list of criteria proposed to assess the quality of online interactive resources for teaching Physics is distributed in three general categories: content, pedagogical effectiveness and user friendliness. Each of these areas contains indicators to evaluate a scale with five possibilities of assessment, and NA means not applicable and the numerals 1-4 correspond to the legend shown in table 3. The incorporation of the option NA (Not Applicable) results from the event that there are resources whose evaluation in any of the criteria does not apply or is not justified. The adoption of these three areas of evaluation stems from our alliance with the already agreed classification by the entities discussed above.

In the field of Content each application should be scientifically correct, with clarity and accuracy in language use and with no prejudices of race or gender and incitement to violence of any kind.

The Pedagogical Effectiveness field is designed to ensure the adequacy of the teaching activities, by assessing items such as its framework the curriculum guidelines of the level of

education that is intended, the adequacy of the degree of difficulty that presents and ease of integration with supporting materials to class (or classes) that is supposed to be used on.

The ease of use domain appreciates the ease of navigation and available features such as audio/video and printing results or export them to other programs.

The evaluation process culminates with a space where the evaluator can describe some other important aspects which have not been adequately protected in the list of criteria.

### **Survey to a Portuguese Physics teachers' sample**

In order to validate (or not) the quality criteria suggested in the list, a sample of Portuguese Physics teachers was asked about the way they find, use, and evaluates the quality of interactive online resources. The preliminary results of this exploratory study are presented.

#### Survey's presentation

The questionnaire was created on a spreadsheet of "Microsoft Excel" and sent for teachers to complete and return via email.

There were 3 groups of questions, relating to:

- a) how Physics teachers find and select valuable resources;
- b) their opinion about the relative importance of evaluation criteria;
- c) their suggestions for promoting the use of online interactive resources for teaching Physics.

A total of 182 Physics teachers email addresses received the questionnaire as an attached file. The e-mail contained a text presenting the project, requesting help in its implementation, and ensuring anonymity and assuring that the data collected are used only for research purposes.

From this sample, 50 teachers answered the questionnaire, 31 female. On average, teachers' age was about 43 years old and they were just half of their career. Most respondents have a higher education degree and mainly teach secondary school levels.

#### Survey's main conclusions

About the main difficulty for the use of interactive online resources, respondents consider the lack of computer equipment in classrooms, followed in importance by the difficulty in finding reliable resources, lack of time to prepare and implement activities with the resources and lack of assessment of quality of materials. More specific operational aspects of the application in the classroom are considered of lesser degree of difficulty.

In the ranking of quality criteria for evaluation of resources in the content area, respondents clearly established as first priority scientific correction, followed by clarity in the use of terms and physical concepts and the contribution to the conceptual understanding of physics. Aspects as the idiom, the goals presentation, the absence of prejudices and stereotypes and the inclusion of graphs and multimedia elements were minored by the teacher's sample.

In the pedagogical domain, the primary criterion is that of promoting the development of learning, followed by integration into the curriculum, the appropriateness to the target audience and the flexibility of teaching resource. Factors such the existence of appropriate guidelines for teaching, the establishment of links to other materials that reinforce or

complement the resources, the availability of tools that contribute to the formative evaluation and the adequacy of the descriptors of the characteristics the resource (metadata) are less important for teachers.

In the technical field, the most important criteria are the accuracy and perceptibility of the operating mode of the application and the ease of navigation. The layout attractiveness is clearly considered as a subsidiary factor.

Comparing the preliminary results of this study with the proposed criteria list we can conclude that in all domains there is a very strong correspondence in the most theoretical and generic criteria at the expense of those specific and operational.

To promote the use of resources, respondents valorize the teacher training in planning and implementing classes with these kind of resources as well as accessing to the feedback of the resource's use by other teachers. They also considered important ensuring that resources have been evaluated by their peers and being able to search quickly and efficiently a resource for particular program content. The need for suggestions on how to implement the interactive online resources in teaching and learning is strongly addressed too.

Three quarters of teachers surveyed expressed their willingness to participate in a project to create a community of physics teachers who use, evaluate and propose the inclusion of new features.

## **Conclusion**

The ease of finding and accessing interactive online resources is a critical requirement to promote their use in the classroom.

One of the most important conditions for Physics teachers to select and use these resources as didactical tools is their submission to an efficient and pragmatic evaluation process and having the possibility of accede to the feedback of other teachers' implementation in class.

We present a list of 12 evaluation criteria distributed in three general categories: content, pedagogical effectiveness and user friendliness.

The results from a survey to a sample of Portuguese Physics teachers show that the criteria proposed in the list strongly match with the teachers' needs and perceptions about this issue, particularly the most generic ones.

The pedagogical potential of online interactive resources for the teaching of Physics can only be fully realized unless it satisfies the quality criteria and existence of guidelines matching the curricula and teaching practices.

## **References:**

Altherr, S., Wagner, A., Bodo, E., & Jodl, H. J. (2004). Multimedia material for teaching physics (search, evaluation and examples). *European Journal of Physics*, 25, 7–14.

Bratina, TA, Hayes, D. & Blumsack, SL (2002). *Preparing Teachers To Use Learning Objects. The Technology Source*. Available online (17/08/2010) at <http://ts.mivu.org/default.asp?show=article&id=1034>



- Clinch, J., Richards, K. (2002). *How can the Internet be used to enhance the teaching of Physics?* *Physics Education*, 37 (2), pp. 109-114
- Costa, F. A. (2005). Avaliação de software Educativo. Ensinem-me a pescar! *Cadernos SACAUSEF I*, 45-53
- Dani, D. E., & Koenig, K. M. (2008). Technology and Reform-Based Science Education. *Theory Into Practice*, 47(3), 204 – 211.
- Eteokleous, N. (2008). Evaluating computer technology integration in a centralized school system. *Computers & Education*, 51(2), 669–686.
- Geissinger, H. (1997). Educational software: Criteria for evaluation. In R. O. R. P. R. Kevill (Ed.), *Proceedings of ASCILITE'97 on what works and why?* (Vol. 219-225). Perth, WA: Curtin University of Technology.
- Lê, Q., Lê, T. (2007). *Evaluation of Educational Software: Theory into Practice*. Available on-line (12/08/2010) at <http://eprints.utas.edu.au/1328/1/11-Le-P.pdf>
- Mathelitsch, L. (2008). Multimedia in Physics Teaching and Learning. In B.G. Sidharth, F. Honsell, O. Mansutti, K. Sreenivasan and A. De Angelis (Eds.), *Proceedings of the International Conference "Frontiers on Fundamental and Computational Physics"* (pp. 217-220). American Institute of Physics.
- Ramos, JL (1998). A criação e utilização de micromundos de aprendizagem como estratégia de integração do computador no currículo do ensino secundário. *PhD dissertation*. University of Évora.
- Renkl, A & Atkinson, RK (2007). Interactive Learning Environments: Contemporary Issues and Trends. An Introduction to the Special Issue. *Educational Psychology Review* 19:235–238
- Richards, C. (2005). The design of effective ICT-supported learning activities: exemplary models, changing requirements, and new possibilities. *Language Learning & Technology*, 9(1), 60-79.

# **A modelling learning path, integrated in the secondary school curriculum, starting from the initial phases of physics education**

*Onne van Buuren,  
University of Amsterdam,  
the Netherlands  
[O.P.M.vanBuuren@UvA.nl](mailto:O.P.M.vanBuuren@UvA.nl)*

*Peter Uylings,  
ILO, University of Amsterdam,  
the Netherlands*

*Ton Ellermeijer,  
C.M.A., Amsterdam,  
the Netherlands.*

## **Abstract**

Until recently most research on computational modelling in education has been focussed on the higher educational levels, often with courses on a project base only. During the past two years we developed a learning path on system dynamical graphical modelling, integrated into the Dutch physics curriculum, starting from the initial phases (age 13-15 years). A first version of this path has been tested in classroom. In this paper, after giving an overview of this path, we will focus on the part in which students had to build a complete model themselves for the first time. Student's understanding of the graphical relation structure, of the distinction between difference equations and direct relations, and of the relation between difference equations and stock-flow diagrams is investigated. It appears that students mix up different aspects of dependences of variables. We identified a number of misconceptions which students showed when discriminating between direct and difference equations. Finally, we detected a number of problems students may have when building graphical models.

## **1. Introduction.**

In this study on modelling in physics education, the emphasis will be on quantitative computational modelling with graphical modelling tools, such as Stella, PowerSim, and Coach 6, based on the 'system dynamical' stock and flow approach developed by J.W. Forrester in the early 1960s (Forrester, 1968). From a mathematical point of view, this mainly concerns the numerical integration of ordinary difference and differential equations. It appears that understanding the conceptual network of system dynamics can be difficult for students (Booth Sweeney & Sterman, 2000; Cronin, Gonzalez, & Sterman, 2009; Westra, 2008). A new way of thinking is required which takes considerable time to learn. Therefore modelling should not be limited to only one theme or subject, but should be integrated into the curriculum (Schecker, 1998). There are several reasons to start such a curriculum from the initial phases of science education (van Buuren, Uylings, & Ellermeijer, 2010). In the past two years we have been working on the design of a learning path on modelling, integrated into the first two years of physics education (age 13-15), with the intention of expanding it to the subsequent years in future. A pilot version of this path has now been tested in classroom. Our approach can be classified as educational design research (van den Akker, Gravemeijer, McKenney, & Nieveen, 2006). In educational design research, materials are designed, tested and improved in subsequent cycles. In this paper, our focus is on establishing the required orientation elements for building system dynamical graphical models.

## 2. Main design principles

### 2.1 The modelling process as a starting point

Modelling involves the modelling process as a whole. This process is described schematically in figure 1, which is derived from the proposal of the commissions for renewal of the Dutch science curricula. (see for example: Commissie Vernieuwing Natuurkundeonderwijs havo/vwo, 2006). This proposal states:

“Student must be able to analyse a situation in a realistic context and reduce it to a manageable problem, translate this into a model, generate outcomes, interpret these outcomes, and test and evaluate the model.”

This process is often called a cycle, because for the testing, validation and evaluation of the model it is necessary to revisit the realistic context situation.

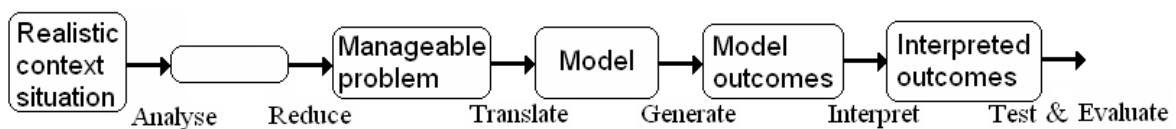


Figure 1: Modelling process

We used this process as a framework on which the determination of the elements for our learning path can be based. A first description of this framework and its implications has been given elsewhere (van Buuren, Uylings, & Ellermeijer, 2009). In this paper, we confine ourselves to the translation of the manageable problem into a system dynamical graphical model.

### 2.2 Analysis of the main elements of system dynamical graphical models

Following Gal'perin (van Parreren & Carpay, 1972), we want to establish a complete orienting base for working with the main elements of system dynamical modelling. Therefore we will give a brief analysis, using examples from Coach 6 (Heck, Kedzierska, & Ellermeijer, 2009).

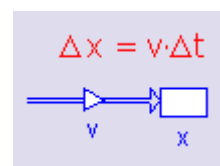
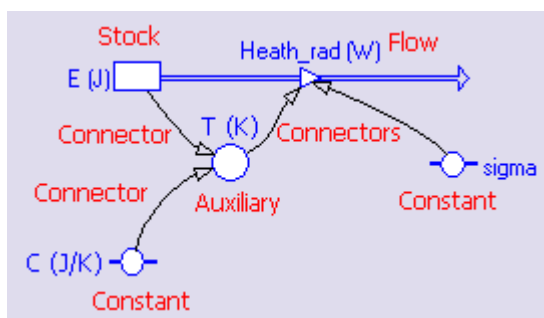


fig. 3: difference equation and its graphical representation. The independent variable  $t$  is not visualised.

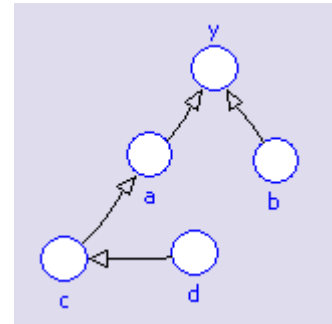
fig. 2: representation of variables in Coach

Five types of variables can be distinguished: stock- (or state-) variables, flow variables, the independent variable, auxiliary variables, and constants (fig. 2). The type of a variable is not an intrinsic property, but must be derived from its role in the process, which is a process of numerical integration of a system of equations. There are two types of relations, difference equations and direct relations.

The graphical equivalent of a difference equation is a combination of a stock variable and one or more flow variables (fig. 3). The flow variables are to be integrated; the stock variable is the integral and needs an initial value. Often, stock-flow combinations are introduced in a qualitative, intuitive way: “the flow tells the stock how to change”.

All other relations are direct relations. All five types of variables can be part of direct relations, but only flow variables and auxiliary variables can be defined by them. They are indicated by connectors (fig. 2; in Dutch: ‘relation arrows’).

In this paper we will make a distinction between variables which are connected directly and variables with one or more other variables in between. We will call the former “direct linked” and the latter “secondary linked”. Direct linked variables are used explicitly in the definition (formula) of the variable they are linked to, secondary linked variables are not (fig. 4).



*Fig. 4: variables a and b are directly linked to y, c and d are secondary linked to y.*

We consider the following, not necessarily exhaustive list of aspects to be important for the formation of a complete orienting base:

1. Difference equations, as describing differences or changes (of the stock variable).
2. The role and use of stock variables.
3. The need of an initial value for the stock variable.
4. Numerical integration and iteration.
5. The role of the independent variable and its step size.
6. The role and use of flow variables.
7. The role and use of auxiliary variables and constants.
8. The graphical representation of difference equations.
9. The distinction between difference equations and direct relations.
10. The graphical representation of direct relations.
11. The role of connectors in showing the relational structure of the model.

These aspects must be addressed on our learning path.

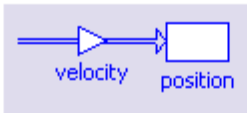


### 3. Design and implementation of the learning path

#### 3.1 Overview of the learning path.

We want our students to be able to build simple models before the end of the second year of physics education (age 14-15 years). Before we can establish the required orienting base, an orientation on graphical models must be given (for example, by using models for simulation), students must become acquainted with the software tool, an understanding of graphs must be developed, and a few of the above aspects, such as difference equations and initial values, must already be introduced. For the development of the orienting base it is important that modelling activities are not restricted to one domain. We choose six domains. For each new domain, before the start of a modelling activity, some conceptual domain knowledge must be developed first.

Figure 5 gives an overview of our design, starting with the module on kinematics, in which students use simple models for simulation as a first orientation, and ending with the module on heat, in which a model must be built without the help of the teacher. In the preceding module on dynamics all elements required for model building are integrated for the first time, so at this point the required orienting base should be established.

We need a curriculum to which not only interventions must be added, but which must be adaptable as a whole. The self-written curriculum of the HML (the Hague Montessori Lyceum) fulfils this purpose.

Age	13-14 years		
Domain	Kinematics		Energy
	Part 1	Part 2	
Typical domain content	$x,t$ -graphs, $\Delta x = v_{\text{avg}} \cdot \Delta t$	$v,t$ -graphs	$\Delta E = P \cdot \Delta t$ $E,t$ & $P,t$ -graphs
1. Difference equations	X		X
2. Stock variable	X		Explicit
3. Initial value	Explicit	X	
4. Numerical integration		X	
5. Independent variable	X	Step size	
6. Flow variable	Number	Sketched function	Explicit
7. Auxiliary variables			
8. Graphical representation of difference equations	X		X
9. Difference equations ↔ direct relations			
10. Graphical representation of direct relations			
11. Connectors & structure			
Typical model			 (qualitatively)





Age	14-15 years				
Domain	Molecules	Vibrations	Dynamics		Heat
			Newton	Falling	
Typical domain content	Vacuum pump	$\underline{u} = u_1 + u_2$	$\Delta v = \frac{F}{m} \Delta t$	$F_{\text{air}} = k \cdot v^2$	$\Delta Q = C \cdot \Delta T$ , $P = K \cdot (T_0 - T_1)$
1. Difference equations			X	X	Test
2. Stock variable	X			X	
3. Initial value	X		X	X	
4. Numerical integration	Iteration		X		
5. Independent variable	Pump beat	Part of relation			
6. Flow variable	Simple direct relation			Explicit	
7. Auxiliary variables		Explicit		X	
8. Graphical representation of difference equations	X			Explicit	
9. Difference equations ↔ direct relations				Explicit	
10. Graphical representation of direct relations	X	Explicit		X	
11. Connectors & structure		Explicit		Explicit	
Typical model					

Fig.5: Overview of the learning path. "X" means that an aspect is used more or less tacit, as a first orientation, or that it is repeated.



cycle, after analysis of video measurements, the model is revisited and expanded with air resistance. The formula  $F_{air} = k \cdot v^2$  as a candidate for air resistance creates the need for a computer model. At this point, the orienting base is introduced. See section 3.4. Finally, the model is built, validated and explored. This module takes 4 lessons of 80 minutes.

### 3.4 Design of the introduction of the complete orienting base for model building.

The purpose of this part of the module on falling is the integration of all main elements of graphical model building. All aspects of section 2.2 must be addressed, especially the new ones. In addition, students must learn to use the interface for creating models.

For the introduction of the elements a variety of topics is used, both from within physics as from other fields, in order to force our students to orientate on the essential features. In order to avoid the risk of the module becoming too complicated for our students, we decided:

1. to confine ourselves, implicitly, to time as the independent variable;
2. not to make the distinction between constants and auxiliary variables yet, but to use the latter for constants as well;
3. to confine ourselves to models containing only one stock variable.

For difference equations the term “change formulas” is introduced, because we expected this to be a more meaningful term to our students.

The lessons start with an introduction of the main elements, followed by a number of learning tasks. The six most important tasks are three pen-and-paper exercises and three model building tasks (figure 7).


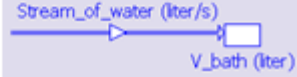

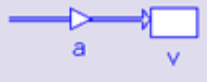
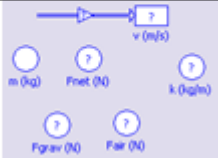
Task	Main learning goal	Aspects addressed	Model involved
1. Exercise 1	to use the structure of a graphical model to recognize on which other variables a variable depends	10. Graphical representation of direct relations. 11. Connectors & structure.	 (see fig. 11)
2. Exercise 2	to recognize which type of relation is required in a given situation	9. Difference equations ↔ direct relations	
3. Exercise 3	to connect a difference equation to a stock-flow model	8. Graphical representation of difference equations	 (see fig. 16)
4. Building task 1	interface knowledge, how to create a graphical model in the modeling environment	2. Stock variable 6. Flow variable 8. Graphical representation of difference equations	$\Delta x = v \cdot \Delta t$  (see fig. 3)
5. Building task 2	the development of a more general view on stock and flow variables	2. Stock variable 6. Flow variable 8. Graphical representation of difference equations	$\Delta v = a \cdot \Delta t$  (see fig. 8)
6. Building task 3	translation of an extended physics model (set of formulas) in a graphical model	All (except 4 & 5)	 (see fig. 9)

Fig. 7: Six learning tasks.



## Design considerations of the learning tasks

1. Exercise 1 aims at the development of an understanding of the main structure of graphical models, especially with respect to direct relations. Students are asked about dependencies in a given graphical model.
2. Exercise 2 is on the recognition of the difference between direct relations and difference equations. Eleven realistic ‘situations’, from physics, economy and biology are presented. In each situation a direct relation or a difference equation is involved. In some situations a formula is given, other situations are described in words only. Students must decide whether a situation corresponds to a “change formula” or to a “direct relation”. Situations involving feedback mechanisms, e.g. about interest, are not included, because in a small pilot study with upper level students, we noticed that students got mixed-up by these situations, whereas at this stage these situations do not help in clarifying the difference between both types of equations.
3. Exercise 3 is on the graphical representation of difference equations. Students must be able to translate a difference equation into a stock-flow combination and also to interpret a stock-flow combination as a difference equation. In this exercise students are asked to do the latter.
4. In building task 1 the required equipment knowledge is developed. Students must build the simple stock-flow model of figure 3, supported by an instructional video, integrated in Coach.
5. The purpose of building task 2 is the development of a more general view on stock and flow variables. Students must learn that variables can have different roles, depending on the equations they are part of. Therefore, we let them build a model in which one of the variables from building task 1 was involved, but in a different role. See figure 8.
6. In building task 3 an extended model must be build. This is the final goal of the module. In order to save time and, possibly, some frustration, a semi-built model is provided, in which all variables are already present, but to which all relations and values must be added (figure 9). This model must be finished, fitted to experimental data and explored.

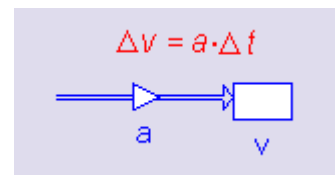


Fig. 8: Model from building task 2. In building task 1,  $v$  was a flow variable, in this task it is a stock variable.

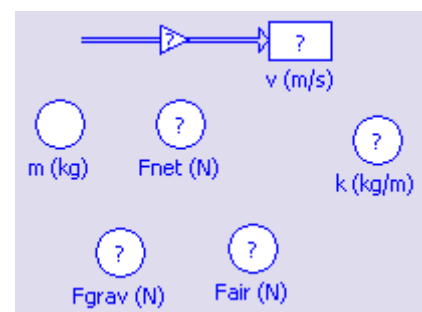


Fig.9:Initial modelling screen of building task 3.

## 4. Set up of the classroom experiment on model building

In this experiment we focus on the understanding by students of aspects of the elements of graphical models.

### 4.1 Research questions

Partial research questions are:

1. How do students understand relation structures?
2. How do students understand the difference between difference equations and direct relations?
3. How do students understand the relation between stock-flow patterns and difference equations?
4. Which problems do students have when building an extended model?



## 4.2 Setting

The lessons were tested in four third-year classes (14-15 years), numbered 3A to 3D, consisting of 124 students, with two different teachers. The researcher was one of the teachers. Students worked individually or in small groups. Because they were allowed to collaborate, results of individual students may not be independent. The lessons were planned near the end of the year, and for several reasons we ran out of time. Therefore, in 3A and 3B, we decided to concentrate on experimenting and modelling and to skip other parts of the module. In 3C and 3D, we let students work at their own pace. As a consequence, not all students completed all modelling activities, but those who did followed the learning trajectory as intended. This may have led to a bias in our results for faster students.

## 4.3 Data collection

Data from three of the exercises and two of the modelling tasks were analysed. During classroom activities, notes were made of the questions and problems of our students. We analysed delivered results, consisting of produced models and written or typed answers. In addition, we made screen recordings and a few detailed observations of individual students. See figure 10.

Research question	Task	Classroom observation	Delivered results	Screen recordings	Indiv. Obs.
1. Relation structure?	Exercise 1	3A+3B (55)	24 (42)		
2. Difference equation or direct relation?	Exercise 2	(pilot 4HV) 3A+3B (55)	20 (36)		1
3. Stock-flow pattern and difference equation?	Exercise 3	3A+3B (55)	21 (38)		
	Building task 2	3A+3B (55)	28 (48)	3 (6)	
1. Relation structure? 4. Building problems?	Building task 3	3B (28)	24 (44)	2* (3) (1 inc. sound)	1

Fig. 10: data collection table. Students were working in small groups or individually. Numbers between brackets are the numbers of individuals involved.

## 5. Results

Results of this first, incomplete version on the learning path, with a possible bias towards faster students, must be viewed only as indicative. The results will be used to make changes in future versions, however. In presenting the results, we follow the order of the research questions.

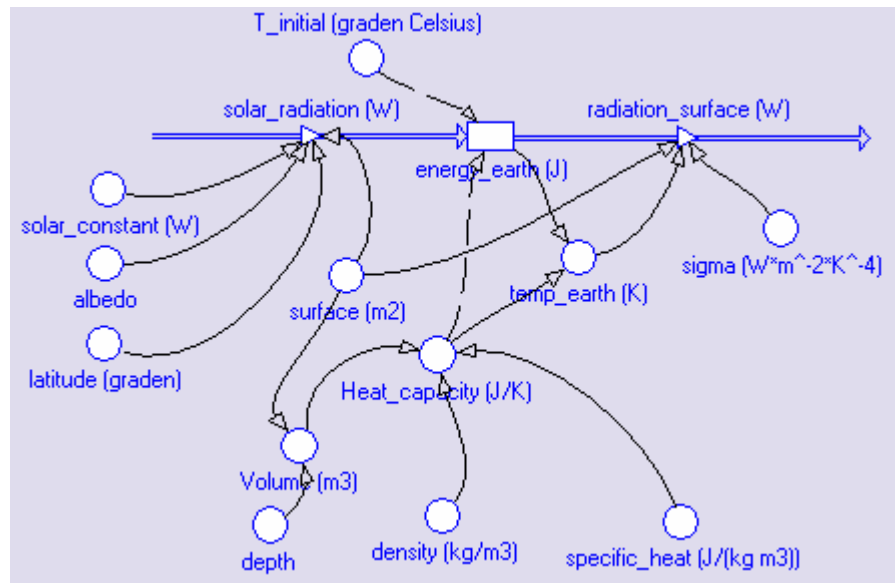
### 5.1 Understanding of the relational structure

In exercise 1 students' understanding of the structures of graphical models as shown by connectors is investigated. Students were given a picture of a model (figure 11) and were asked on which other variables some specific variables depended, according to the model. Both direct and secondary linked variables were present. In the subsequent questions they were asked explicitly about dependencies on the secondary linked variables. The terms "direct" and "secondary" were not mentioned to our students.

From analysis of 24 students' answers on the first question it appeared that, in 20 of these, all direct linked variables were mentioned correctly, but in only three of these the secondary linked variables were mentioned also. This is in accordance with our classroom observations. Many students wondered whether secondary linked variables should be regarded as "dependent" on each other.

To the subsequent explicit questions about dependencies on secondary linked variables, 21 answers were correct, but many students added comments, like “Partially”, or “Yes, in a very indirect way”.

Fig. 11: Model used for showing how connectors reveal dependencies.



Apparently, these questions draw attention to a relational aspect of secondary linked variables that is not automatically recognized properly. For two reasons this aspect is important. First, students may misinterpret models when they do not realise that the influence of secondary linked variables is direct and instantaneous.

Second, when students start building models themselves, they may follow a qualitative, dependency based approach, by drawing the relational structure first and adding the formulas later, as is advised by some authors (Westra, 2008). PowerSim even forces its users to do so. Our results indicate that this may lead to a less adequate relational structure. An example of this can be seen in a screen recording of building task 3 (figure 12). Some of our students started building their model by drawing a connector from the friction constant  $k$  to the acceleration  $a$ . Although  $a$  is influenced by  $k$ ,  $k$  does not appear directly in the formula  $a = \frac{F_{net}}{m}$ , so it should have been

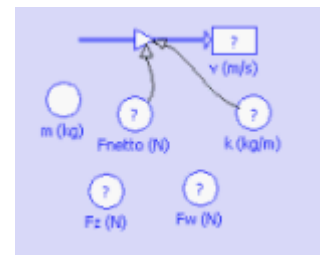


Fig. 12: Screenshot of the initial phase of the model of two students. The flow variable is the acceleration  $a$ .

secondary linked, through the friction force  $F_w (= F_{air})$ , especially since our students were not familiar with substitution. With a more quantitative, equation based approach, this problem may be avoided.

## 5.2 Understanding of the distinction between direct relations and difference equations

We used classroom observations and 20 sets of delivered student answers of the 11 questions of exercise 2 in order to investigate how students understood the difference between direct relations and difference equations. On average, in each set of student answers, 8 questions were answered correctly. Therefore, we conclude that it is possible for students to determine the type of relation in most situations. We analysed these data further, looking for criteria that students may have been using, consciously or not, when answering these questions. Results are summarised in figure 13.

Only the question in which  $\Delta$ -notation was used explicitly was answered correctly by all students.  $\Delta$ -notation apparently is a good trigger. However, the idea that “a change formula

always involves time”, as one student explicitly stated, may have interfered. We found six sets of answers that might be based on this invalid idea, including the 2 sets that were totally correct. This idea may be the consequence of our simplification only to use time as independent variable. Orientation on this aspect will be improved in the next version. This requires both situations with other independent variables and situations with time as part of a direct relation.

Criterion: presence of:	Valid	Students' conclusion	Sets of student answers in which this criterion may have been used (max. 20)
1. formula with $\Delta$ -notation	+	Change formula	20
2. variable “time”	-	Change formula	$\leq 6$
3. variable with a name suggesting change	-	Change formula	10
4. written physics formula vs. a relation in words from outside physics.	-	Change formula / direct relation	3

Fig. 13: criteria, possibly used by students in distinguishing between difference equations and direct relations.

The highest number of wrong answers occurred on the only question concerning direct relations to a variable suggesting ‘change’. See figure 14. Between “Expenses” and four auxiliary variables exists a direct relation, but it is tempting to consider “Expenses” as a flow variable to a stock-variable “capital”. The possibly twofold roles of flow variables can be confusing.

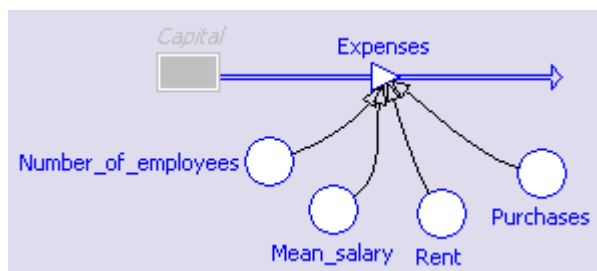


Fig. 14. “The expenses of a restaurant depend on the number of employees, the rent of the building, the mean salary and the purchases” may be modelled as in this picture. If “Expenses” is seen as “change of capital”, it’s role is twofold.

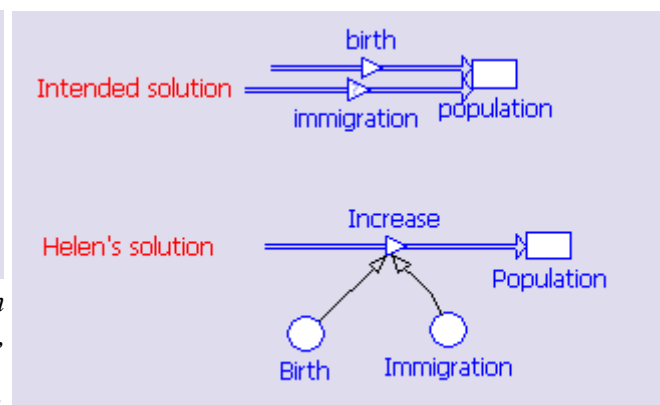


Fig. 15. Intended and alternative solution for “The population of a country increases through birth and immigration”.

Analysing a number of errors that appeared to be correlated, we arrived at the possibly underlying misconception that “a written physics formula means a difference equation, a relation in words from outside physics indicates a direct relation.” This must be investigated more closely in future.

Finally, students may interpret situations not as intended, but slightly different, with correct alternative models as a possible consequence. An example is shown in figure 15.

### 5.3 Understanding the relation between stock-flow patterns and difference equations

In order to investigate students' understanding of the relation between stock-flow patterns and difference equations, we asked students to give the equation corresponding to a stock flow model (figure 16, exercise 3). We received 21 students' answers, from which 6 answers were clearly wrong.

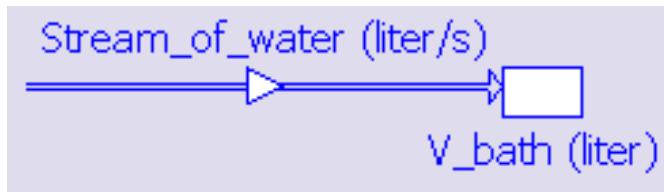


Fig. 16.

In modelling tasks 1 and 2 students had to do the opposite, building models corresponding to the equations  $\Delta x = v \cdot \Delta t$  and  $\Delta v = a \cdot \Delta t$ . We observed many students having problems with task 2. These could be solved by stressing the similarity of the formulas and highlighting the twofold role of  $v$ . Eventually, 23 out of 28 models that were sent in appeared to be correct.

Initially, we expected a system of coupled difference equations to be too complicated, but confronting students with such a system may actually be an effective way to clarify the possibly twofold role of variables. Results of a pilot with such a system (fig. 17) with five student couples were promising, but further testing is necessary.

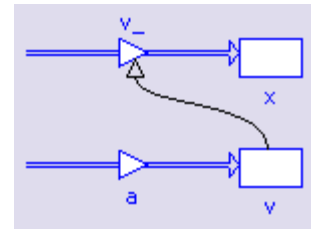


Fig. 17: Model of coupled difference equations, making the twofold roles of  $v$ , as both a stock and a flow variable, more explicit.

### 5.4 Building problems and errors

In order to detect building problems, we did classroom observations and analysed screen- and audiorecordings of building task 3, in which students had to build a more extended model. The variables for this model were already on the modelling screen, but relations still had to be defined (fig. 12). All required physics formulas could be known to our students.

The problems and errors detected are summarised in figure 17.

Students' building problems and errors
1. Not understanding if a variable must be defined by a number or a formula.
2. Use of cyclic definitions.
3. Defining a stock variable by a direct relation
4. Finding a building order

Fig. 17.

Some students initially thought that only numbers are used in the definitions of variables. Even if students knew that formulas could be used, some of them found it hard to decide whether a number or a formula was required. An example is the value for the friction constant  $k$ , which eventually must be determined by curve fitting. It was not clear to some students why  $k$  should not be defined by the formula  $k = \frac{F_{air}}{v^2}$ . In order to solve this problem, the special icon for constants could be introduced, but then the concept of a constant must still be clarified.

Some students tried to use relations in a cyclic way, defining the acceleration  $a$  as  $\frac{F_{net}}{m}$ , while simultaneously defining  $F_{net}$  as  $m \cdot a$ . Another example is the cyclic definition of friction force and friction constant.

A number of students, said not to know where to start building. This may be an underlying problem for the problems mentioned above. For students it is not a priori clear which variable should be defined by which other variable. The question for students is how to determine an appropriate building order. Some authors advise to start building from a variable ‘in which we are interested’. The question is, if this approach is adequate in all cases. For example, in building task 3 we are ‘interested’ in determining the constant  $k$ , but  $k$  is not an appropriate starting point. A more fundamental approach follows from the fact that our type of modelling is developed for integration only. The stock (the integral), is determined by the flow, the opposite is not possible. This largely determines the order in which the model can be built. After putting a stock and one or more flows on the screen, we can advance by defining the flows. For our students, to whom the difference between  $\Delta x = v \cdot \Delta t$  and  $v = \frac{\Delta x}{\Delta t}$  is just the difference between multiplying and dividing, this one way dependence must be clarified.

Some students tried typing “ $a * t$ ” in the window for the initial value of the stock variable  $v$ . Apparently, they tried to define  $v$  in this way. This might be caused by an asymmetry in graphical models between direct relations, which must be defined explicitly, and difference equations, that are defined automatically by stocks and flows, and by a lack of understanding of the integrating process.

## 6. Conclusions

We conclude that students can understand simple relation structures as shown by connectors, but attention must be paid to the difference between direct linked and secondary linked variables. Students are able to distinguish between difference equations and direct relations in realistic situations, but a better base of orientation must be provided to prevent misconceptions, and more attention must be paid to the possibly twofold role of variables in one model. The latter may also facilitate the translation from a difference equation to a stock-flow model, and vice versa, for students.

When building graphical models, problems can arise concerning the definitions of variables and the building order. These problems will be investigated more closely in a future version.

## References

- Booth Sweeney, L., & Sterman, J. D. (2000). Bathtub Dynamics: Initial Results of a Systems Thinking Inventory. *System Dynamics Review*, 16, 249-294.
- Commissie Vernieuwing Natuurkundeonderwijs havo/vwo. (2006). Concept Examenprogramma natuurkunde havo. Retrieved from <http://www.nieuwenatuurkunde.nl/>
- Cronin, M. A., Gonzalez, C., & Sterman, J. D. (2009). Why don't well-educated adults understand accumulation? A challenge to researchers, educators, and citizens. *Organizational Behavior and Human Decision Processes*, 108(1), 116-130.
- Forrester, J. W. (1968). *Principles of Systems*. MIT Press.
- Heck, A., Kedzierska, E., & Ellermeijer, T. (2009). Design and implementation of an integrated computer working environment for doing mathematics and science. *Journal of Computers in Mathematics and Science Teaching*, 28(2), 147-161.
- Schecker, H. P. (1998). *Physik - Modellieren*. Stuttgart: Ernst Klett Verlag.
- Westra, R. (2008). *Learning and teaching ecosystem behaviour in secondary education*. Utrecht: CDβ Press.
- van Buuren, O., Uylings, P., & Ellermeijer, T. (2010). Towards a learning path on computer modelling. In D. Raine, C. Hurkett, & L. Rogers (Eds.), *Physics Community and*

- Cooperation: Selected Contributions from the GIREP-EPEC & PHEC 2009 International Conference.* Presented at the GIREP conference 2009, Leicester.
- van Parreren, C. F., & Carpay, J. A. M. (1972). *Sovjetpsychologen aan het woord*. Groningen: H.D. Tjeenk Willink.
- van den Akker, J., Gravemeijer, K., McKenney, S., & Nieveen, N. (Eds.). (2006). *Educational Design Research*. London and New York: Routledge.

# High-Speed Video Analysis of Two-Dimensional Movement of Objects onto Fine Beads

Minoru SATO

minoru@tokai.ac.jp

*School of Science, Tokai University,  
4-1-1 Kitakaname, Hiratsuka, Kanagawa, 259-1292, Japan.*

Fine spherical polystyrene beads, which are industrial materials of styrene form, or fine spherical glass beads, which are grind media for industrial process, are useful for frictionless demonstrations of dynamics and kinematics. The fine polystyrene beads (the average of the diameter is 280  $\mu\text{m}$  and the standard deviation of the diameter is 56  $\mu\text{m}$ ) and the fine glass beads (the average of the diameter is 491  $\mu\text{m}$  and the standard deviation of the diameter is 38  $\mu\text{m}$ ) function as ball bearings to reduce the friction between a moving object, e.g. glass Petri dish, and the surface of the board. The polystyrene beads onto the glass board or the glass beads onto the acrylic acid resin board are electrified by static electricity. Therefore, the beads adhere to the board and arrange themselves in the aperture-triangular-lattice-like pattern. The movement characteristic of a Petri dish that moves on the fine beads that adhere to the board is shown by video analysis using a USB camera and a digital high-speed camera (CASIO, EX-F1). The movement of the Petri dish on the fine beads onto the board is good linearity, but the friction of the beads is not too small. The high-speed video showed that only a small number of beads behind the bottom of the Petri dish supported the Petri dish. The number of the beads that supported the Petri dish that caused the friction is about 0.14.

## INTRODUCTION

Two-dimensional kinematics demonstrations are difficult to apply in practice by friction. In case of horizontal motion, many teaching materials are developed and some of them, such as the dry ice pack, the ball bearings and the air table<sup>1)</sup>, have come into general use in classrooms or laboratories. These conventional apparatuses, however, are not easy to demonstrate in the classroom for the material or the noise.

Sawamoto et al. have developed the method of demonstrations using the fine polystyrene beads onto a glass board<sup>2)</sup>. These polystyrene beads function as ball bearings to reduce the friction between the moving objects (glass Petri dishes or metal disks) and the surface of the glass board. Therefore, the polystyrene beads are suited to demonstrate some two-dimensional kinematics from quietness and easy handling.

In this paper, each of the movement characteristic of a glass Petri dish that moves on

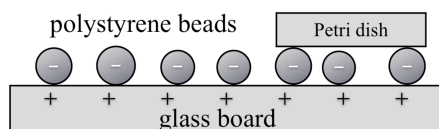
the fine polystyrene beads that adhere to the glass board and the movement characteristic of a glass Petri dish that moves on the fine glass beads that adhere to the acrylic acid resin board are shown by video analysis using a USB camera and a high-speed digital camera.

## MATERIALS AND METHODS

The apparatus of frictionless two-dimensional kinematics demonstration consisted of a moving object and a flat table. The table was assembled into the combination of fine spherical polystyrene beads and a flat glass board (Plastic Beads Table, PBT) or the combination of fine spherical glass beads and a flat acrylic acid resin board (Glass Beads Table, GBT). The moving object utilized for a glass Petri dish. The fine beads function as solid lubricant between the board and the Petri dish.

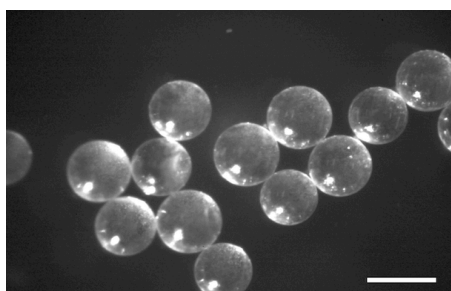
The PBT, shown schematically in FIGURE 1, consisted of a glass board (583mm  $\times$  478mm, 5mm in thickness), fine solid spheri-

cal polystyrene beads (NaRiKa, D20-1406-01), and a glass Petri dish (51mm outside diameter, 11mm thick, weight 16.4g). The glass board supports the fine polystyrene beads and the Petri dish. The fine polystyrene beads are originally made for industrial materials of styrene form.

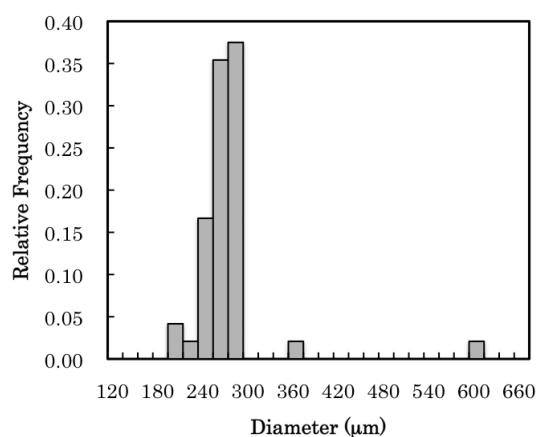


**FIGURE 1.** Schematic of the PBT setup (the scale is incorrect). The apparatus of two-dimensional kinematics demonstration with a low friction consists of a glass board (583mm×478mm, 5mm in thickness), fine solid spherical polystyrene beads (NaRiKa, D20-1406-01), and a glass Petri dish (51mm outside diameter, 11mm thick, weight 16.4g). The fine polystyrene beads function as solid lubricant between the glass board and the Petri dish. The typical size of the fine polystyrene beads is 300 $\mu$ m.

As shown in FIGURE 2, it had been understood that the shape of the fine polystyrene bead was almost sphere from the observation with the microscope. FIGURE 3 shows the frequency distribution of the diameter of the polystyrene beads. The range of the diameter of the beads was from 200 to 600  $\mu$ m. The average of the diameter of the beads was 280  $\mu$ m, and the standard deviation of the diameter was 56  $\mu$ m ( $n = 48$ ). It is noted that a few beads have the extremely larger diameter, about twice the average size.

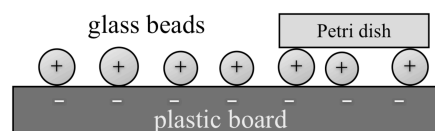


**FIGURE 2.** Micrograph of the fine solid polystyrene beads. Scale bar, 300 $\mu$ m.



**FIGURE 3.** The relative frequency distribution of the diameter of the fine polystyrene beads. The average of the diameter of the beads is 280 $\mu$ m, and the standard deviation of the diameter is 56 $\mu$ m ( $n = 48$ ).

The GBT, shown schematically in FIGURE 4, consisted of a flat acrylic acid resin board (583mm×478mm, 5mm in thickness), fine solid spherical glass beads (Potters-Ballotini Co.,Ltd (PBJ), GB190M), and a glass Petri dish (the above-mentioned). The flat acrylic acid resin board supports the fine glass beads and the Petri dish. The fine glass beads are originally made for grinding media of industrial process.

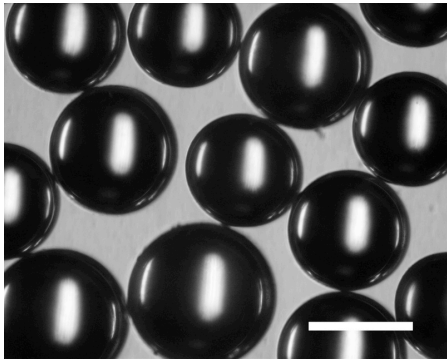


**FIGURE 4.** Schematic of the GBT setup (the scale is incorrect). The apparatus of two-dimensional kinematics demonstration with a low friction consists of a flat acrylic acid resin board (583mm×478mm, 5mm in thickness), fine solid spherical glass beads (Potters-Ballotini Co.,Ltd (PBJ), GB190M), and a glass Petri dish (51mm outside diameter, 11mm thick, weight 16.4g). The fine glass beads function as solid lubricant between the flat acrylic acid resin board and the Petri dish. The typical size of the fine glass beads is 450 $\mu$ m.

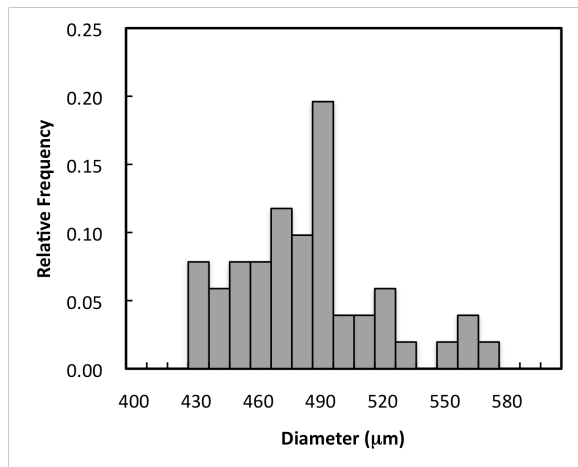
As shown in FIGURE 5, it had been understood that the shape of the fine glass bead



was almost sphere from the observation with the microscope. FIGURE 6 shows the frequency distribution of the diameter of the glass beads. The range of the diameter of the beads was from 430 to 570  $\mu\text{m}$ . The average of the diameter of the beads was 491  $\mu\text{m}$ , and the standard deviation of the diameter was 38  $\mu\text{m}$  ( $n = 51$ ).



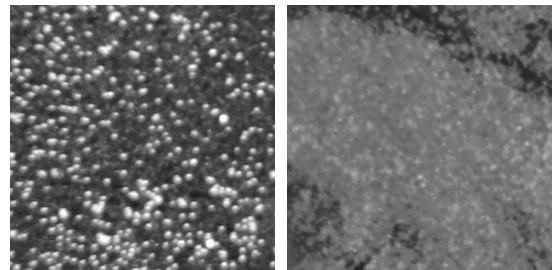
**FIGURE 5.** Micrograph of the fine solid glass beads. Scale bar, 400 $\mu\text{m}$ .



**FIGURE 6.** The relative frequency distribution of the diameter of the fine glass beads. The average of the diameter of the beads is 491 $\mu\text{m}$ , and the standard deviation of the diameter is 38 $\mu\text{m}$  ( $n = 51$ ).

The fine polystyrene beads scattered on the plate glass and the fine glass beads scattered on the plate flat acrylic acid resin are electrified. The electrified reason is a difference of the position of the triboelectric series of polystyrene or acrylic acid resin and glass.

In the case of the PBT, the polystyrene beads are negatively electrified, and the glass board is positively electrified. As a result, the polystyrene beads adhere onto the glass board, and arrange themselves at intervals in the triangular-lattice-like pattern (FIGURE 7, left). It is noted that the beads arrange themselves in the aperture-triangular-lattice-like pattern. In contrast, the polystyrene beads scattered on aluminum foil are not electrified. The beads stick mutually on the aluminum foil, but don't stick to the aluminum foil (FIGURE 7, right).



**FIGURE 7.** Close-up of the fine polystyrene beads scattered on the glass board (left), and on aluminum foil (right). Because the position of the triboelectric series is different, the polystyrene beads adhere onto the glass board, and arrange themselves in the aperture-triangular-lattice-like pattern. In contrast, the beads stick mutually on the aluminum foil, but don't stick to the aluminum foil.

In the case of the GBT, the grass beads are positively electrified, and the acrylic acid resin board is negatively electrified. Consequentially, it becomes a similar situation to the PBT though the charges are opposite.

In order to low frictional properties of the apparatus for two-dimensional kinematics demonstration, the PBT and the GBT were compared with an air table by video analysis. The air table (SHIMADZU RIKA CORPORATION, GTV-100) is an ordinary apparatus for two-dimensional kinematics demonstration. The air that blows off through the fine perforations with the top-board allows the object to glide relatively friction-free. Since the property of friction-free, the air table was used standard to evaluate low frictional prop-

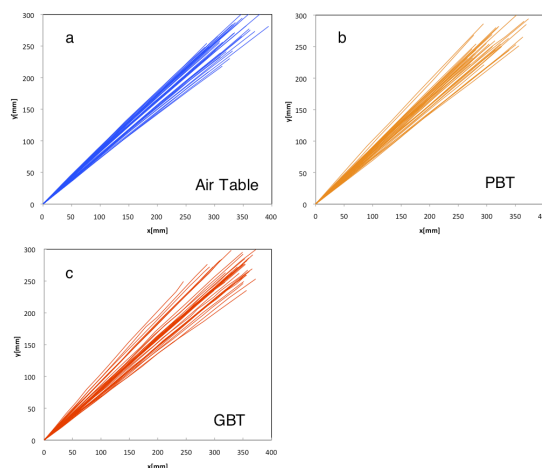
erties of the apparatus. The top-board of the air table was the same size as that the board of the PBT and the GBT (583mm×478mm). There was a USB camera (Logicool, Qcam-Pro3000) to take movies of the movement of the object (The same Petri dish as the case of the beads was used) for video analysis in each apparatus. The image size of the camera was adjusted to capture SD video (640×480 pixels), and the frame rate of the movie was adjusted to 5fps. The installation position of the camera was set up in the height that became 1mm/pixel on the center of the boards. In addition, a digital clock (unit of minimum measurement was 0.01s) was put on the position that entered the capturing image. The digital clock was used to measure the accurate interval time of frames.

In addition, to know what movement the fine polystyrene beads did under the Petri dish high-speed videos were taken. The digital high-speed camera (CASIO, EX-F1) was put on the position in which the Petri dish passed the right under. The frame rate of the high-speed video was adjusted to 600fps.

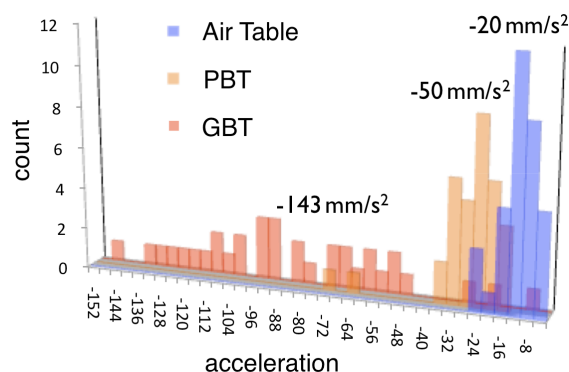
## RESULTS AND DISCUSSION

FIGURE 8 shows the trajectories of the Petri dish as a moving object obtained from the result of the video analysis. The trajectories of the Petri dish on the air table (FIGURE 8, a), on the PBT (FIGURE 8, b), and on the GBT (FIGURE 8, c) contain 35 trials respectively. The same Petri dish was used in all the cases. The results of the fine beads were similar to the air table except a few cases. As the evident from FIGURE 8, the linearity of the movement was in good agreement with the fine beads to the same extent as the case of the air table. There are two reasons for the goodness of linearity of the movement with the fine beads. The first reason is that the shape of most of the beads is almost perfectly spherical (FIGURE 2 and FIGURE 5). And the second reason is that the beads arrange themselves at intervals

(FIGURE 7, left). The reason for that the linearity might become bad in a few cases was not known.



**FIGURE 8.** Trajectories of the Petri dish as a moving object obtained from the result of the video analysis. The same Petri dish was used in all the cases. The number of trials was 35 respectively. **a**, In case of the air table. **b**, In case of the PBT. **c**, In case of the GBT.



**FIGURE 9.** Distribution of accelerations of the Petri dish as a moving object obtained from the result of the video analysis (same trials as FIGURE 8). The mean acceleration of the Petri dish for the air table (blue) was  $-20\text{mm/s}^2$  (s.d.  $10\text{mm/s}^2$ ), for the PBT (orange) was  $-50\text{mm/s}^2$  (s.d.  $23\text{mm/s}^2$ ), and for the GBT (red) was  $-143\text{mm/s}^2$  (s.d.  $73\text{mm/s}^2$ ).

FIGURE 9 shows the distribution of accelerations of the Petri dish as a moving object obtained from the result of the video analysis (calculation from the same data as the trajectories seen in FIGURE 8). The mean accel-

eration of the Petri dish for the air table was  $-20\text{mm/s}^2$  (s.d.  $10\text{mm/s}^2$ ), for the PBT was  $-50\text{mm/s}^2$  (s.d.  $23\text{mm/s}^2$ ) and for the GBT was  $-143\text{mm/s}^2$  (s.d.  $73\text{mm/s}^2$ ). This had been shown that the friction of the GBT is not too small, but the PBT was similar to the air table. The reason for that the friction was not too small was the moment of inertia and the rolling resistance of the beads. This suggests that if the number of the beads supporting the Petri dish reduces, the resistance becomes small.



**FIGURE 10.** Composite photograph of movement of the fine polystyrene beads under the moving glass Petri dish was taken by the digital high-speed camera (CASIO, EX-F1). This reversal image was made from ten consecutive frames of the 600fps high-speed video.

The movement of the fine polystyrene beads under the moving glass Petri dish was taken by the digital high-speed camera (CASIO, EX-F1). The beads under the glass Petri dish were visible through the bottom of the Petri dish. FIGURE 10 shows one piece of photographs composed from the high-speed video. This composite photograph was made from ten consecutive frames of the 600fps high-speed images. Additionally, to make easily to see, this composite photograph reversed black and white. Therefore, the black point in the white background in the photograph corresponds to the bead, the gray circle corresponds to the rims of the Petri dish each frame, and the black line in the gray circles corresponds to the bead that moved under the Petri dish. As shown in

FIGURE 10, this composite photograph indicates that only a small number of beads support the Petri dish (it shows in yellow lines in the photograph). The ratio of the number of supported beads to the total number of behind the Petri dish is 0.14 (the number of trials was 8). This is due to the fact that a few beads have the larger diameter in its distribution.

The results may be summarized as follows: the movement of the Petri dish on the PBT / GBT was good linearity, the friction of the beads, however, was not too small. The number of the beads that supported the Petri dish that caused the friction was about 14%. This suggests that if the number of the beads supporting the Petri dish reduces, the resistance becomes small. More detailed work is necessary to examine whether to have related to the friction of the Petri dish on the PBT / GBT and the ratio of the number of supported beads to the total number of behind the Petri dish. If the friction is reduced, it is possible to use the fine polystyrene beads and the glass beads as an apparatus for two-dimensional kinematics demonstration. However, in that case, it is necessary to deal with the health hazard and the environmental hazard. The experimenter will have to wear the goggle and the mask, and to take care not going out of the fine polystyrene beads to the environment. The safe demonstration method will have to be researched in the future.

## ACKNOWLEDGMENTS

I would like to thank Prof. Takashi Yagi, Mr. Hiroshi Kiyuna and Ms. Yuka Takagi for the micrographs and Potters-Ballotini Co.,Ltd (PBJ) for a generous gift of the glass beads.

## REFERENCES

- 1) E. M. Rogers, *Nuffield Physics Pupils' text years 1 and 2*, Longman Group Ltd, London, 1978.
- 2) S. Sawamoto, K. Hosotani, N. Idris, K. H. Kurniawan, Y. I. Lee, B. J. Ahn, K. Ishii, and K. Kagawa, *J. of Sci. Edu. in Japan* **32**, 98-102 (2008).

# The Virtual and Remote Laboratory for Snell's Law at the FisL@bs Portal

Luis de la Torre<sup>1</sup>, Juan Pedro Sánchez<sup>2</sup>, José Sánchez<sup>1</sup>, Carmen Carreras<sup>2</sup>, Manuel Yuste<sup>2</sup>, and Sebastián Dormido<sup>1</sup>

<sup>1</sup> Department of Computer Sciences and Automatic Control of UNED, ldelatorre@bec.uned.es, {jsanchez, sdormido}@dia.uned.es

<sup>2</sup> Department of Material Physics of UNED, {jpsanchez, ccarreras, myuste}@ccia.uned.es

## Abstract

FisL@bs is a network of virtual and remote laboratories for physics higher education via the Internet. The network is distributed between different Spanish universities and it offers to students the possibility of performing hands-on experiences in different fields of physics from their homes in two ways: simulation and real remote operation. These laboratories are all accessible for anyone with an Internet connection and a Java compatible web browser. This paper gives an overview about how this portal works and the hardware and software tools used to create it. In addition, this paper also describes one of the experiments already available at this portal: Snell's law.

## I. Introduction

Traditional laboratories may sometimes present a low ratio between their use and their costs [1]. By allowing a remote access to these laboratories, their frequency of use can be increased thanks to the creation of networks of educational institutions interested in the same shared experiments. Although the economical aspect is important, there are other benefits tied to these laboratories. The most obvious one is their improved accessibility with respect to their traditional counterparts: since they can be used from students' homes, anybody can access to them, even handicapped people. Another advantage of remote laboratories is their increased availability thanks to their capability to operate 24 hours a day without constant supervision. Finally, the safety of the laboratory devices is also guaranteed due to the software-controlled remote use of these resources.

Therefore, FisL@bs<sup>1</sup>, a network of remote and virtual laboratories for physics higher education via the Internet, not only reduces the necessity of students to travel to real laboratories in distance education courses but it also expands the experimentation possibilities of traditional laboratories thanks to the sharing of network's resources as well as to their fulltime operability. Since the didactical setups at FisL@bs can be used by students from any university, laboratories implementation and maintenance costs are drastically reduced. In FisL@bs, students perform each experiment twice (in simulation and in remote) and so, they can check the differences between the theoretical model and the real system and search for a plausible explanation of any observed discrepancy. Finally, since the virtual experiments are always performed before the remote ones in this approach, simulations also serve students as a first contact with the studied phenomena and with the methodology they must use for each particular experiment.

As for every other web-lab at FisL@bs, the optics experiment presented in this paper (Snell's law of refraction) consists of four components: a Web-based learning environment or Learning Management System (LMS), a Java applet, a didactical setup for the considered experiment, and a LabView application. eMersion [2] is a LMS that provides student/professor communication links, makes references, theory and exercises accessible to students, and offers a file management system for the saved data, obtained during the

---

<sup>1</sup> FisL@bs homepage: <http://labfis.uned.es/FisLabs>

experimentation sessions. The Java applet (made with Easy Java Simulations, EJS) carries out two functions: 1) the control, visualization, and evolution of the experiment in simulation mode, and 2) it acts as user interface for the experiment in remote mode. The third component is the real physics experiment setup while the LabView application is a program used to control it.

## II. Web-Based Laboratories Environment

Following the structure of the web-based laboratories applied in the Autom@tL@bs project [3], FisL@bs uses the same client-server architecture, where TCP/IP is the communication protocol for exchanging data between them. Fig. 1 shows this communication architecture, where arrows going from the client-side sender to the command parser and from the server-side sender to the receiver represent the communication link. More information about the client-side and server-side implementations can be found in Sections II.A and II.B, respectively. A specific example of this communication is described in Section III, illustrated with Snell's law experiment.

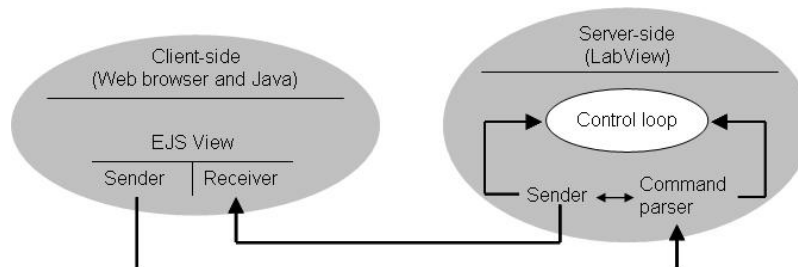


Fig. 1. Client-server architecture. The communication between both parts is based on the TCP/IP protocol. The server runs the remote experiment while the virtual one is locally running in the client side.

### A. Client-side implementation

The client side is a Java applet created with Easy Java Simulations<sup>2</sup> (EJS) [4] and contained in the eMersion environment. When a student connects to the web-lab, his/her browser will show three windows. Fig. 2 shows a printout of the web-lab to study Snell's law using the simulation. The upper window lets the user examine the list of activities s/he must do, consult the documentation, change the language of the interface, and log off. The right window shows the files generated during the use of the active laboratory (virtual or remote) such as data files and graphics images. By means of this window, students can send these files or e-mail to the instructor in charge of the corresponding subject. Files can also be deleted, edited, or downloaded to the student's local computer. Finally, the central window contains the EJS applet with the GUI to work with the simulated experiment (virtual lab) or to control and visualize the real one (remote lab). Initially, this window always shows the GUI with the simulated experiment.

Although the simulated experience is carried out at the client side, once a student has successfully completed the programmed activities of the virtual experiment, s/he will be allowed to take the next step: the access to the remote laboratory. The EJS-based applet contains a button (the one showing two computers in the bottom left corner of the applet in Fig. 2) for connecting to the real equipment. After pressing this button, the applet switches from the view of the virtual experiment to the real one and the student can interact with the

<sup>2</sup> Easy Java Simulations (EJS) is an authoring tool written in Java that helps non-programmers create interactive simulations in Java. It can be downloaded for free from: <http://www.um.es/fem/Ejs/>

true laboratory. In the client side, interaction with the remote laboratory is done from the applet (the EJS View) using the special calls provided by the JIL class [5], the client-side sender and receiver commands of Fig. 1. These special calls are in charge of the communication dialog with LabView in the server side by using TCP functions and routines that the JIL server hides. While the receiver command is continuously used for downloading the real data from the server side and refreshing them in the EJS applet View (client side), the sender command is only executed to communicate with the LabView application when a student has changed a value in the EJS View.

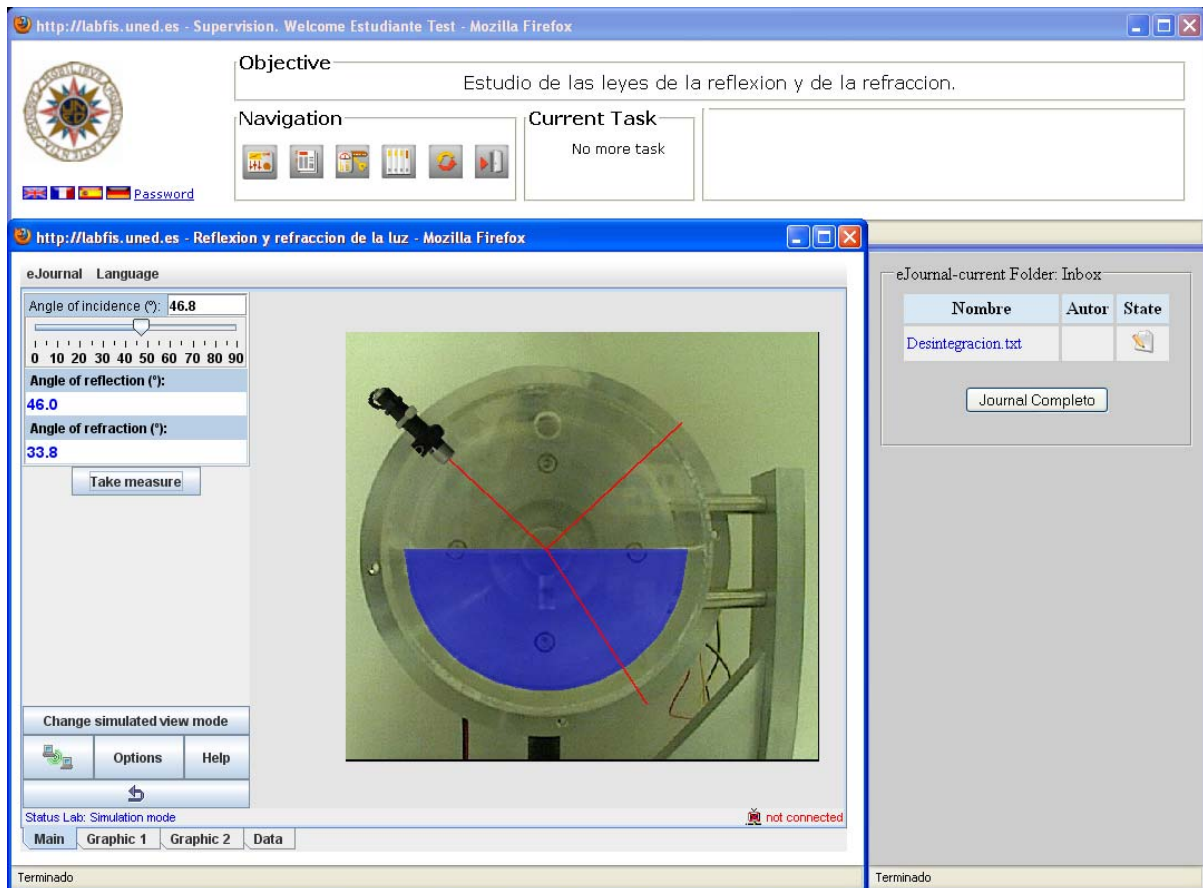


Fig. 2. eMersion environment and user interface of the virtual experiment corresponding to Snell's law. The simulation uses pictures of the physical devices used for the real experiment. The right window shows the data files obtained in any experimentation session of the user.

## B. Server-side implementation

In this scheme, the same computer runs the Web server, which provides the applets and the eMersion environment, and the real-time controller. As said before, this controller has been developed in LabView and contains two information loops. The first one is an asynchronous loop that is in charge of communicating with the applet (receiving the user actions and sending the process state). The second one is a synchronous loop that controls the physical devices of the didactical setup in real time.

The asynchronous loop may present some problems when trying to control certain processes, specially those presenting fast dynamics, due to possible network delays. However, this is an issue that must be analyzed for each particular case (taking into account the time scale of the process dynamics) and, if problems appear, there is not a unique way to deal with them.

However, Section III presents an experiment whose control is easy enough to avoid this type of problems.

### III. An Experiment in Optics: Snell's Law

Snell's law (or the law of refraction) along with the law of reflection constitute axioms already stated by Sir Isaac Newton in [6] and they are both part of the fundamental laws in optics. Particularly, Snell's law describes the relationship between the angles of incidence ( $\theta_i$ ) and refraction ( $\theta_r$ ), when light (or other waves) passes through a boundary between two different isotropic media (air and water, for instance). This relationship is given by the indices of refraction of the two media ( $n_1$  and  $n_2$ ) in such way that the ratio of the sines of these angles is a constant,  $n$ . Mathematically:

$$n_1 \sin \theta_i = n_2 \sin \theta_r \Rightarrow \frac{\sin \theta_i}{\sin \theta_r} = \frac{n_2}{n_1} \equiv n \quad (1)$$

When  $n_2 > n_1$ ,  $\theta_r < \theta_i$  so the light comes closer to the perpendicular line to the boundary. On the contrary, when the light passes from a more refracting media to a less refracting one ( $n_2 < n_1$ ), it gets away from the perpendicular line.

As later described, the didactical setup allows the study of the relationship between the angle of refraction and the angle of incidence for both cases:  $n_2 > n_1$  and  $n_2 < n_1$ . In this second case it is possible to check that there is a certain value of the angle of incidence for which the angle of refraction reaches  $90^\circ$ . This angle is known as limit angle, since for greater values of the angle of incidence the refraction phenomena disappears and the boundary between the two media behaves like a mirror. This is known as the total reflection effect.

The didactical setup for Snell's law real experiment (Fig. 3) was built using aluminium pieces, a transparent plastic container, a webcam, a laser pointer, and a stepper motor. The aluminium pieces make up the basic structure of the didactical setup which holds the plastic receptacle (containing water, for example), the motor, and the green laser pointer. An aluminium disc that rotates around its central axis supports the laser pointer. The stepper motor controls the rotation of the disc and so, the position of the laser pointer in relation with the plastic container and the angle in which its light incidences over the water ( $\theta_i$ ). Since the motor is controlled by steps of  $0.9^\circ$ , the error is  $\delta\theta_i = \pm 0.9^\circ$ . A relay is also used in order to switch on/off the laser pointer when a user connects/disconnects to the remote laboratory, respectively. To measure  $\theta_r$ , the graphical user interface (GUI) of the remote laboratory (Fig. 4) lets the user move a virtual pointer over the image given by the webcam. This is done using the lower graduated slider in that GUI. This way, once the user has positioned the pointer where the refracted ray is shown,  $\theta_r$  is measured over the mentioned slider. The estimated error for these measurements is  $\delta\theta_r = \pm 1^\circ$ .

Since the only controlled variable in this experiment is the angle of incidence, there is just one control parameter ( $\theta_i$ ) to be sent from the client-side sender (EJS view, Fig. 1) to the LabView hardware controller in the server side. Finally, since  $\theta_r$  needs to be measured visually during the remote experimentation (using the webcam and the virtual moveable pointer), no information is returned.



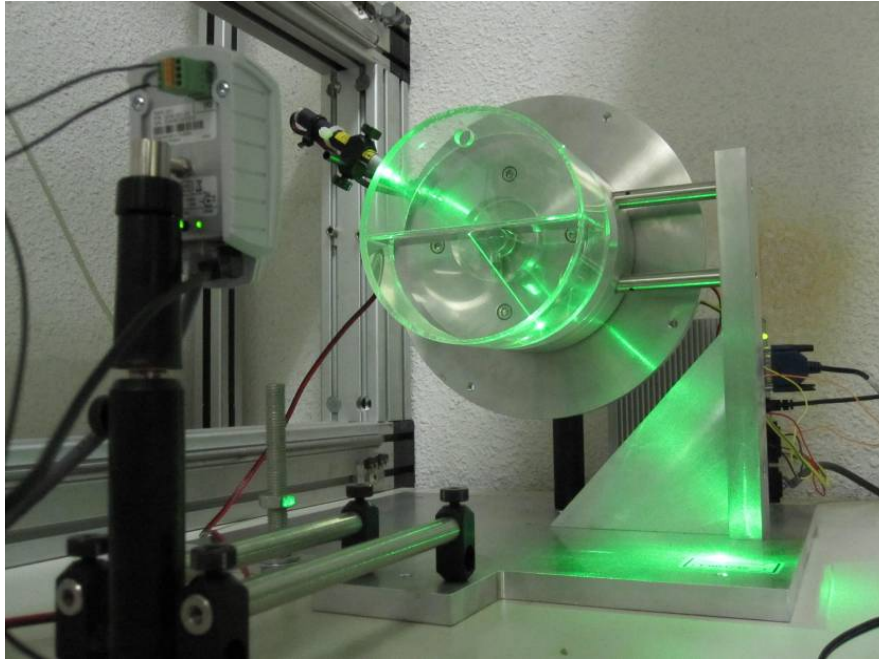


Fig. 3. Didactical setup of Snell's law experiment.

### A. Simulation activities

The simulation for studying the laws of reflection and refraction is based on the didactical setup used for remote experimentation. In this way, the simulated view serves students for getting used to handle the experimental environment.

The main window in Fig. 2 shows a picture of the real system to be used in simulation mode. The container has two different isotropic media in the same proportion. The user can select these media from a list that appears when pressing the "Options" button. After reaching the boundary between the two chosen media, the laser ray splits off into the reflected and the refracted rays. The displays are used for giving to the user the measurements of the three angles: the incident one, the reflection one, and the refraction one. Students can change the position of the laser (and therefore, the incident angle) acting directly over the 2D representation of the system (clicking over the laser and dragging the mouse) or using the slider. Either way, the incident angle changes and the behaviour of the other two angles and rays can be studied.

From the data obtained by means of this simulation, students can carry out several activities:

- 1) Verification of the law of reflection: the angles of incidence and reflection match up.
- 2) Verification of Snell's law: the graphic representation of  $\sin \theta_i$  vs.  $\sin \theta_r$  gives as result a straight line. By performing a lineal regression with the represented data it is also possible to determine the ratio of the refractive indices of the two media, since  $\frac{n_2}{n_1}$  is the slope of the straight line.
- 3) Range of validity of the Gauss approximation: the  $\theta_i$  vs.  $\theta_r$  graphic representation can be approximated with a straight line only for small values of these angles. Within this range, the slope of that straight line can still be considered as the ratio of the refractive indices of the two media.



4) Determination of the limit angle (total reflection phenomena): if the incident media is more refracting than the second one, there is a particular value for the angle of incidence,  $\theta_i \equiv \theta_l$ , such as the ray does not cross the boundary between the two media for higher values of  $\theta_i$  (i.e. when  $\theta_i \geq \theta_l$ ). In these cases, the ray is completely reflected towards the interior of the incident media.

This simulation (as any other at FisL@bs portal) includes a small random error when generating the measured values. For this particular case, the values for the reflection and refracted angles are generated using the theoretical ones and adding a small random error, which can be either positive or negative. This way, although there are uncertainties in the measurements, results are still theoretical. The “Options” button lets users modify the maximum value of this random error, and generate measurements with variable precision.

Using the default configuration, students can determine  $n_2/n_1$  with good enough precision in the simulated experiment: around  $\pm 7 \cdot 10^{-3}$  when ten points are used for the lineal regression, for example.

### B. Remote activities

When a student is connected to the remote laboratory, s/he can check Snell's law using the didactical setup. Fig. 4 shows the GUI of the applet in this mode. Two sliders are shown on the upper left part of the main window: one for controlling the angle of incidence and the other for moving the virtual pointer and measuring the angle of refraction. On the right side, a webcam shows an image of the experiment in real time while the user can use the graphic on the left side to plot  $\sin \theta_i$  vs.  $\sin \theta_r$ . A checkbox labelled “Show rays” allows users to draw over the real image the three free-error simulated rays (incident, refracted and reflected) to immediately compare and contrast the real and theoretical results for each position of the incident ray. All the activities described for the simulated experiment in the previous section can be performed remotely with the didactical setup.

As shown in Fig. 5, Snell's law experiment also offers students the possibility of automatically carrying out lineal regressions of the collected data. Taking into account the measurement errors in both  $\theta_i$  and  $\theta_r$ , students can determine  $n_2/n_1$  with good enough precision in the remote experiment: around  $\pm 8 \cdot 10^{-3}$  when ten points are used for the lineal regression, for example. Therefore, the uncertainties in measurements and results for the real and simulated experiments are very similar, which facilitates the comparison between theoretical and real results.

### III. Conclusions

FisL@bs continues the work initiated with the Autom@L@bs project, expanding its utility from the control engineering education to the science physics education. FisL@bs inherits the well-proven structure of its successful counterpart and just changes the simulated and remote experiments in order to make it suitable for a physics course.

The simulated experiment serves students as a first contact with the studied phenomena in which they can, for the presented example, discover Snell's law and the law of reflection, study the range of validity of the paraxial approximation, and visualize the total reflection phenomena. Continuing with this same example, the remote experience lets students verify these laws with a real experiment. Although this is a quite simple experiment, students would

not only learn about springs and Hooke's law but also about measurement uncertainties, uncertainties calculus and linear regressions.

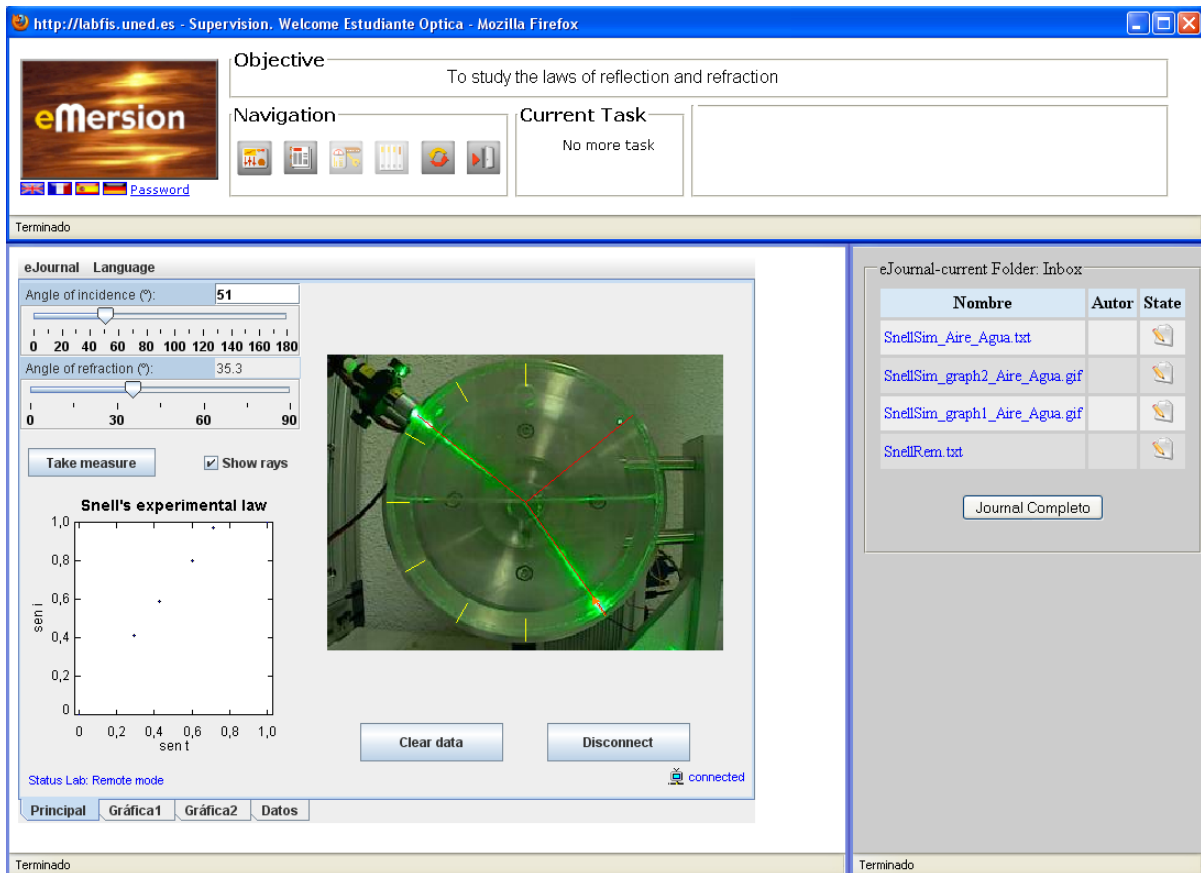


Fig. 4. GUI of the experiment working on the didactical setup. The real ray laser is green while the simulated (theoretical) one is painted in red. The virtual pointer (an orange arrow which can be moved with the lower slider) is used to measure the real angle of refraction.

Other laboratories at FisL@bs that are already operative or still under development are: a couple of experiments on Hooke's law and radiation, a motorized optical bench for the determination of the focal length of a thin lens, and a sensor whose XY position can be remotely controlled to measure the distribution of potential over a resistive sheet of paper with different electrostatic fields.

## References

- [1] Gravier C, et al. (2008) State of the Art about Remote Laboratories Paradigms - Foundations of Ongoing Mutations, *International J. of Online Engineerings*, 4(1), 374-378.
- [2] Gillet D, Nguyen Ngoc A V, and Rezik Y (2005) Collaborative Web-based Experiments in Flexible Engineering Education, *IEEE Transactions on Education*, 48(4), 696-704.
- [3] Vargas H, Sánchez J, and Dorado S (2009) The Spanish University Network of Web-based Laboratories for Control Engineering Education: The Autom@L@bs Project, *European Control Conference*, Budapest, Hungary.
- [4] Esquerre F (2004) Easy Java Simulations: A Software Tool to Create Scientific Simulations in Java, *Computer Physics Communications*, 156(2), 199-204.
- [5] Vargas H, et al. (2009) Web-Enabled Remote Scientific Environments, *Computing in Science and Engineering*, 11(3), 36-46.
- [6] I. Newton (1718) *Opticks, or A treatise of the reflections, refractions, inflections and colours of light. The second edition, with additions.* London.

# **Infrared sensors with multimedia - multimodal and pictured information processing**

**Raimund Girwidz, Michael Lippstreu**, University of Education Ludwigsburg, Germany  
girwidz@ph-ludwigsburg.de

## **Abstract**

This paper pursues two intentions. The first is to present some ideas about how to use modern infrared sensors in school. Especially infrared / non-contact thermometers and infrared motion detectors can improve the experimental possibilities and offer new ways to explore basic phenomena.

The second intention is to show how these devices can be introduced with modern media in a short information sequence. However there are some requirements for effective learning with multimedia. Results from a research project give evidence that it is better to assist animations and illustrations of dynamic, time dependent processes with spoken explanations instead of written text information.

## **1. Introduction – using modern infrared devices in school**

Infrared thermometers, so called, non-contact thermometers, measure temperature from a distance. The measuring principle is based on the infrared radiation emitted by all objects. The intensity and spectral distribution depends on the object's temperature, and is described by Planck's law of black-body radiation. Infrared thermometers make a wide variety of temperature measurement and monitoring accessible to school age students. They enable new or simplified investigations to be carried out with quick and easy measurements. Following thermal footprints are engaging activities for younger students, e. g. finding out, which seat was occupied recently, which cup was filled with a hot or a cold drink, which car was being driven a short time ago.

Nevertheless, introducing and explaining infrared thermometry in schools is not trivial. Therefore a multimedia learning environment was designed to explain infrared radiation and the basics about the measuring principle. Multimedia learning was examined with this software. After a short description of the program, results from a study about the use of multimedia are presented, especially focusing on the multimodality principle. Our study compared spoken with written text explaining further details and / or giving hints for information processing. How should additional information be designed to support visual information (pictures and animations)? Some details will be explained.

## **2. Interesting applications for school**

Non-contact (infrared) thermometers measure temperatures of objects without touching them. Quick and flexible measurements can help students to carry out 'discovery tours' through the world of temperature and collect interesting data. Surface temperatures of various objects are available in less than a second. (More details are described in Girwidz & Ireson, 2011). Some examples for measurements are:

### ***a) Thermodynamic effects of water on the skin or (wet) clothes***

Discussions about the effects of water on the skin, wet or dry clothes can be based on measured data; respectively theoretical considerations can be verified. The effects of evaporative cooling as well as heat conductivity of wet and dry cloths or the function of sweating can be studied.

### **b) Analyzing thermal footprints**

Measuring surface temperatures can indicate: Which car just came in (see fig. 1)? Which chair was occupied in the last minute? Was the television switched on a short time ago? Was the dog or cat lying on the sofa before you came in? Which cup was filled with a hot or a cold drink?



Fig. 1: The temperature of the bonnet can indicate which car just came in.



Fig. 2: Measuring the surface temperature of peripherals can be related to various physiological reactions.

### **c) Temperature of food and drinks**

The temperature of food and drinks can quickly and hygienically be measured with a non-contact thermometer. In particular the measured values can be compared with sensation, e. g. the temperature of an ice cream or of a hot soup.

### **d) Physiological studies**

The skin temperatures of hand or fingers (see fig. 2), can be measured after idle time, when you are freezing or after sports (e. g. running up and down the staircase in the school building). The temperature of peripherals varies with blood circulation and is an important part of the human thermoregulatory system. Other measurements can keep records of the warming up of hands and fingers after holding them into cold water.

### **e) Characteristics of an infrared motion detector**

Can you pass an infrared motion detector without triggering an alert? How does an infrared motion detector work? What kinds of signals activate the sensor? These questions can also be explored by simple experiments, offering a training for scientific working (see also fig. 3).



Fig. 3: An experiment: Trying to "outfox" an infrared motion detector (covering infrared radiation).

### 3. Contents for the multimedia learning environment

How do infrared thermometers and infrared motion detectors work? Students should know some basics about the underlying principles and laws of physics to use them properly. However, according to most curriculums there is not much time available for this. So we developed a multimedia learning sequence to introduce the basics in 45 minutes. (To be precise, there is a short, central circle to inform only about the very fundamental facts, and there are additional modules to develop deeper insights into different topics, see also fig. 4).

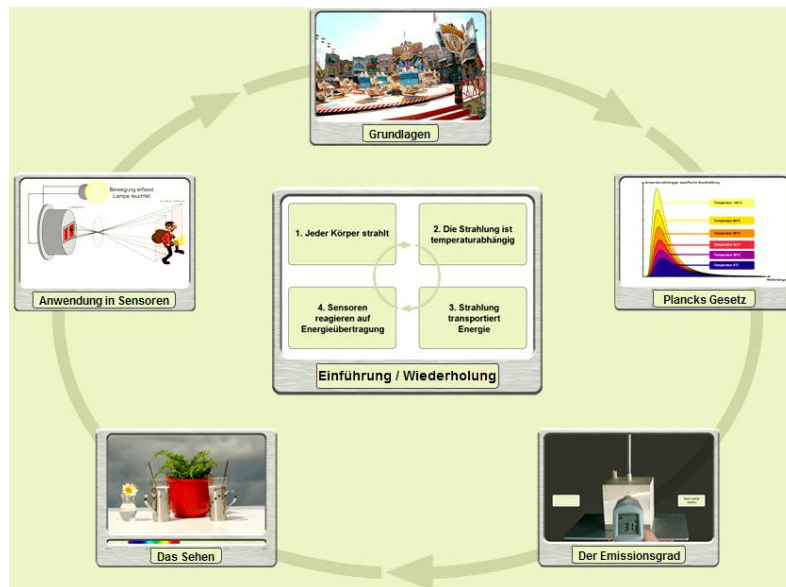


Fig. 4: Modules of the multimedia learning sequence (fundamental, central circle) and additional modules. (outer circle)

The short introduction (inner circle) has four central learning objectives. They are also summarized for students - we call it a "SMS" about the learning objectives:

1. Bodies send out electromagnetic (infrared) radiation.
2. The intensity and the characteristics of the emitted radiation depend on the temperature of the object.
3. Radiation is combined with transport of energy.
4. This is detected by IR sensors.

Beyond this information additional modules also explain how sensor applications work. One example is the infrared thermometer. The most common devices used for sensing temperature include Thermocouples/Thermopiles. The so called thermal detectors absorb a broad band of infrared radiation, usually in the range of 4000 nm to 16000 nm. A black body absorber belongs to the sensor. A thin plate is to reach an equilibrium temperature proportional to the temperature of the target by the exchange of energy through radiation. This is illustrated in an animation (see fig. 5).

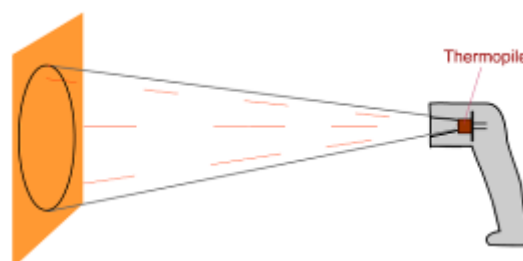


Fig. 5: Animation to illustrate the working of an infrared thermometer

Thermopiles consist of a miniature array of thermocouple junction pairs. The active junctions are mounted on the absorber layer. The reference junctions are connected with the housing (see figure 6). Thermopiles measure the difference of temperature between the active and the reference junctions. A voltage proportional to the radiation is generated by the thermoelectric effect. The front side of such a sensor mounted in a TO-5 type housing can be seen in figure 6.

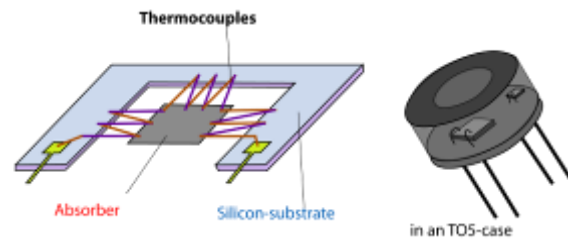


Fig.6: Thermopile and TO-5 housing.

Also basics about electromagnetic radiation are explained (see fig. 7).

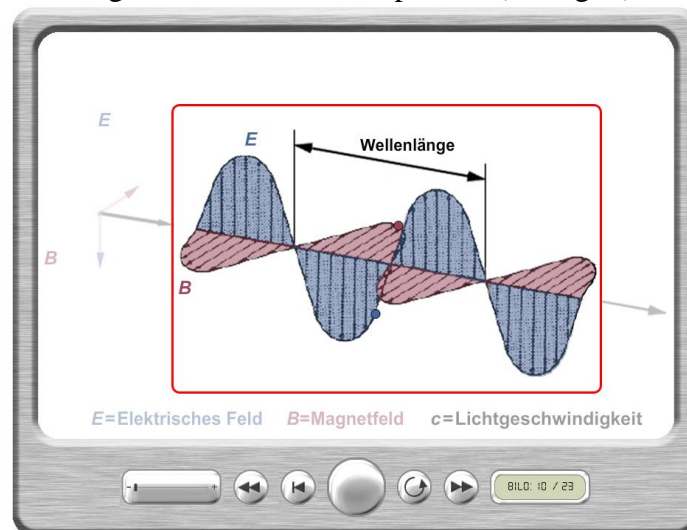


Fig.7: A visual model for electromagnetic waves.

The multimedia learning environment is available via internet [www.physikonline.net/infrared](http://www.physikonline.net/infrared). At the moment there is only a German version online. An English version will show up until January 2011.

#### 4. Research questions and methods

A research project explored how a multimedia learning environment could assist learning. As a part of this project it was analyzed, how additional information (presented as aural information or as a text to read) influenced the processing of pictorial information (modality aspect). Furthermore, the use of animations and series of still pictures for the illustration of dynamic physical processes was compared.

Two different methods were applied. In the first part of this study a questionnaire was given to 251 9<sup>th</sup> and 10<sup>th</sup> graders after working with 4 different versions of the learning environment, using

- a) animations and aural information
- b) animations and written information
- c) still pictures and aural information
- d) still pictures and written information.



Each one of the 10 classes was divided into four subgroups to exclude the effects founded on differences between classes. After working for 45 minutes with the program the students got a questionnaire with 16 items.

In addition to this test a second investigation used an eye tracking system which registered the point of gaze (the focal points) and the motion of an eye. Our system used two mini cameras to record the activities of the eyes (see fig. 8).

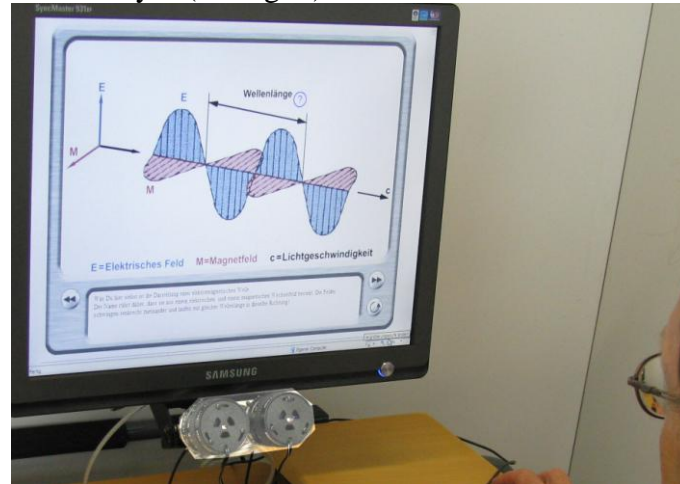


Fig.8: Computer screen and the eye tracking hardware placed below the monitor (highlighted).

A number of 86 students and pupils (not knowing much about physics) took part in this study. The system provided "lines of vision" and "focal points" as explained in the following chapter, and measured the time for picture processing.

## 5. Results

The remarkable results of this study are presented below, concerning three issues.

### a) *Is it better to use spoken or written text?*

In summary, it has to be distinguished between knowledge that is based on pictorial information and text based knowledge. It was significantly better to offer spoken text than written text in combination with illustrations, especially with animations. Whereas, for text based knowledge (information about facts and numbers) written text was better. The data from the test clearly showed this modality effect (see fig. 9).

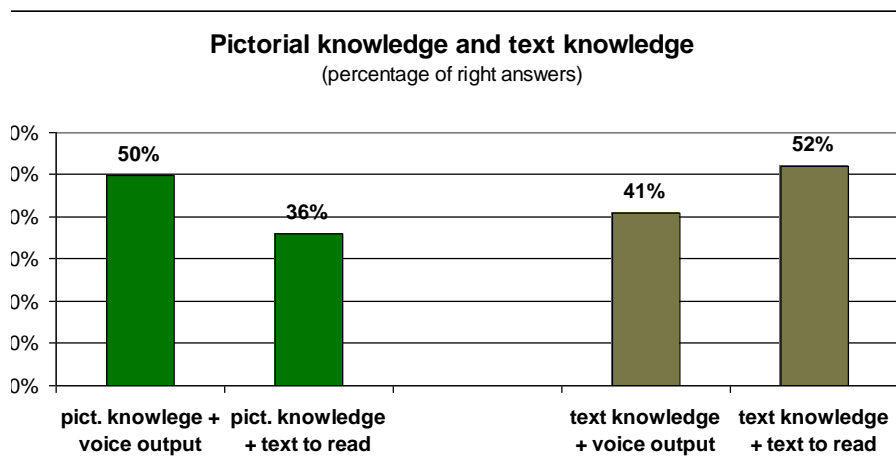


Fig.9: Spoken text vs. written text for pictorial and text based information.

**b) Are animations better than still pictures**

For time dependent, process oriented knowledge the animations led to better outcomes than series of still pictures (see fig. 10).

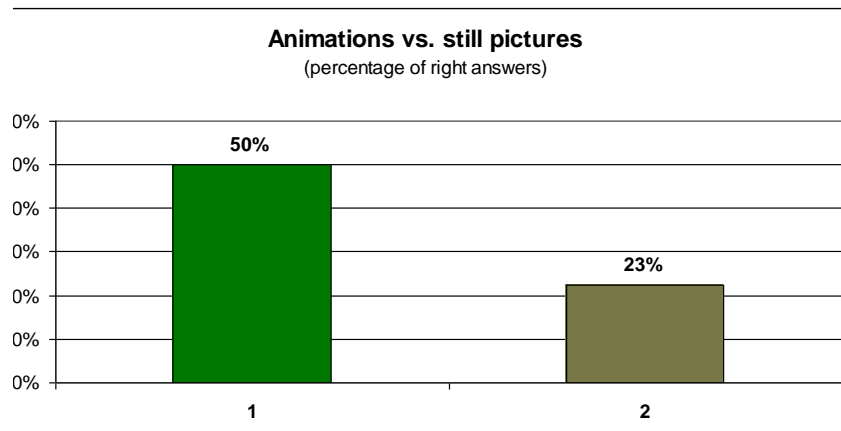


Fig.10: Animations (1) vs. still pictures (2).

**c) Lines of vision, focal points and time for picture processing.**

The eye tracker system showed clearly which part of the monitor was focused on. Three different kinds of presentation were helpful for data analysis. The "scanpath" displays the sequence of gazes which is fundamental for information processing (see fig. 11).

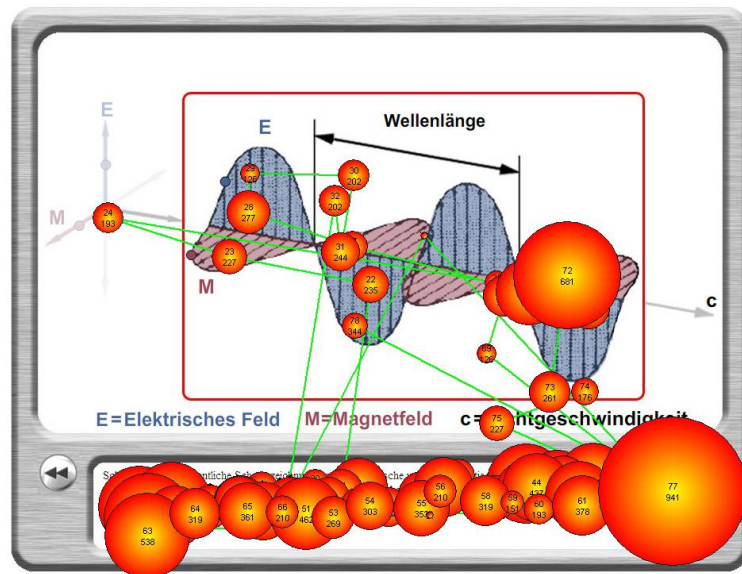


Fig.10: Lines of vision and sequence of gazes.

The "sinn builder" displays areas of visual attention on the screen. The brighter an area in the screenshot the higher the visual attention (see fig. 12). Dark parts were scarcely noticed. The visual attention can also be illustrated in a 3D-plot (see fig 13).



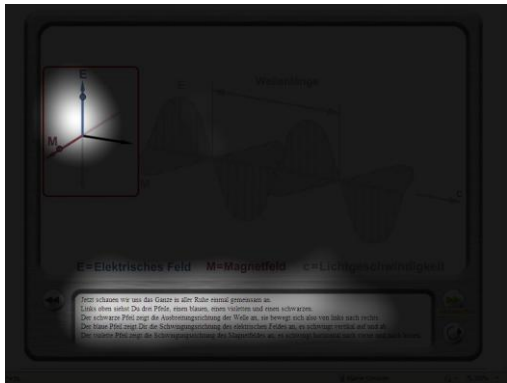


Fig.12: "sinn builder" of visual attention.

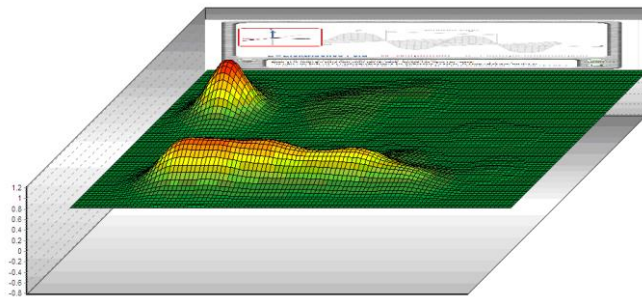


Fig.13: 3D-plot of visual attention.

Also quantitative data are available. The time spent on looking at arbitrary areas can be determined. Our studies show absolutely clear differences between the versions with spoken text and those with written text. With spoken text much more time was available for picture processing, whereas in the versions with written text it took most of the time to read the text (see fig. 14).

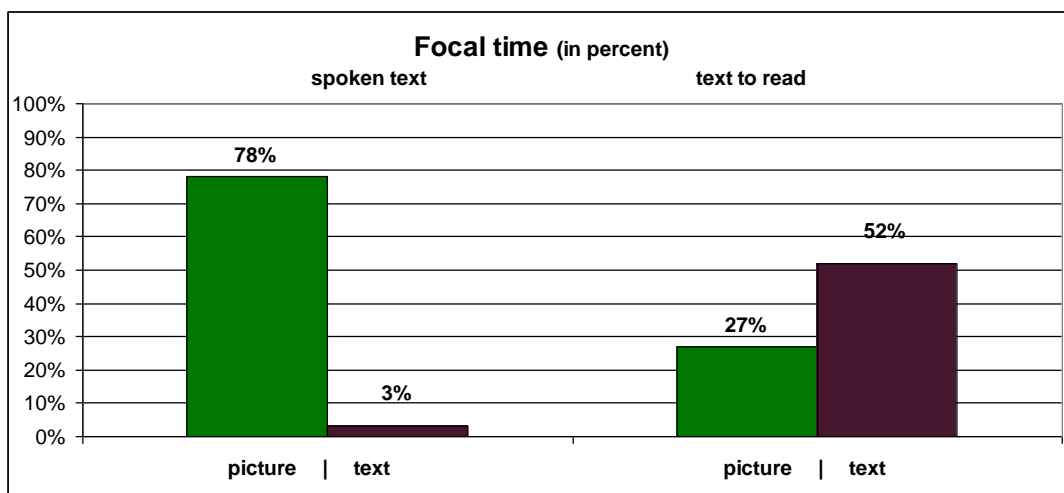


Fig.14: Focal time for pictures and text  
(remark: about 20% of the time is lost because of blinking and unspecific eye movements).

## 5. Discussion and Conclusions

The study concentrated on a special kind of learning material, namely process oriented phenomena that are not directly visible, and where imagination is important for understanding. For time dependent aspects it was good for our students to offer them animations, especially in combination with spoken text. This modality effect is in line with the findings of Mayer (2001).

The eye tracking study clearly showed the reason for this difference. Spoken explanations allow more effective picture processing. There are two reasons for this. First, learners' eyes do not have to jump from text to picture and vice versa. Second, there is much more time to look at relevant areas without interruption.

However, we have to mention clearly that these are results for a special setting of learning content and material, namely process oriented phenomena that are not directly visible in reality.

## **References**

Mayer, R. E. (2001). *Multimedia learning*. New York, NY, US: Cambridge University Press.

Girwidz, R. & Ireson Gren (2011). *The Infrared Thermometer In School Science: Teaching Physics With Modern Technologies*. *Phys. Educ.* in press.

Girwidz, R., Lippstreu, M. & Winterlin, A. (2010). *Animated illustrations – finding critical factors for an effective information processing*. In M. Michelini, R. Lambourne & L. Mathelitsch (eds.), *Multimedia in Physics Teaching and Learning*. *Il Nuovo Cimento C*, Vol. 33, N. 3. Italian Physical Society. (pp. 121-130).

# Self-reflection, comparative reflection and analogical reflection in the framework of metacognitive modelling activities using the ModellingSpace technological environment

George Kritikos<sup>1</sup>, Angelique Dimitracopoulou<sup>2</sup>

<sup>1</sup>PhD Candidate, University of the Aegean, Greece  
*gkritikos@rhodes.aegean.gr*

<sup>2</sup>Professor, University of the Aegean, Greece  
*adimitr@aegean.gr*

## ABSTRACT

The modern educational technological environments do not focus on the transmission of knowledge, but on the triggering of metacognitive functions. Reflection acts as a booster for metacognition. In this work, we present initially a review of the research on reflection in technological environments. Through the review and in combination with the benefits of analogical reasoning, we propose an alternative kind of reflection, the *analogical reflection*, instead of *self-reflection* and *comparative reflection*. Self-reflection is considered as someone's reflection on his/her own actions. As comparative reflection, we consider the reflection on others' actions. By the analogical reflection, we mean the reflection on analogies. Based on the analogical reflection, we outline our pilot research, which is a case study on three groups consisted of two students each. The students work collaboratively in the ModellingSpace technological environment. Our basic hypothesis is the following: In self-reflection, it is very possible that someone cannot recognise his/her own mistakes. In comparative reflection, this possibility is potentially reduced, because perhaps the others do not make the same mistakes. We estimate that this possibility is minimised when the analogical reflection is activated, because it is easier to recognise a strange behaviour in a familiar cognitive domain, where the normal behaviour is well known. Finally, we present briefly an instructional framework, in which students are asked to reason analogically and reflect on modelling activities, in order to exploit and improve their metacognitive skills.

## KEYWORDS

Reflection, analogical reasoning, metacognition, modelling

## INTRODUCTION

Analogical reasoning is a mental process by which learners adapt their knowledge from a familiar cognitive domain to a new unfamiliar domain. Through the analogical reasoning, students exploit their own existed knowledge in the familiar domain in order to understand the studied domain. The two domains are similar in their structure and/or functionality, while students must be capable to analyse and compare them. The models that are created in the framework of analogical reasoning are called analogical models. The analogical system is called "source" while the system that is being studied is called "target". One target may be related with sources from different domains (Meyer, 2002). For example, a computer network (target) could be represented by different analogs (sources), such as road network, rail network or post office. If a characteristic/function of the source shares similarities with the target, the analogy is "positive", while if the characteristic/function is opposite to the target then the analogy is "negative". Negative analogies may generate misconceptions to students and, therefore, they must be clarified. If the characteristic/function of the source seems similar/opposite with one of the target, but is not actually similar/opposite, then the analogy is "neutral" (Harrison, 2002).

## **THE REFLECTION IN TECHNOLOGICAL LEARNING ENVIRONMENTS**

Many researchers have studied the contribution of reflection in learning. Below, we present a review, focusing on the way that reflection arises in technological learning environments.

In educational artificial intelligence, the student model saves information about students' actions. The past artificial intelligence systems used to hide the student model from the student. The modern ones, "Open Learner Modelling" (OLM), bring to light the student model. The student model can be visible to the system's user for self-reflection, or to other users for comparative reflection.

W-ReTuDiS (Web-Reflective Tutorial Dialogue System, Tsaganou et al., 2004) is an OLM system that uses dialogues based on the student model and it is applicable for teaching history. The system asks questions to the students and then returns their answers, annotating the wrong ones or validating the right ones. The students may ask from the system for extra explanations. In such case, the system responds by setting up a dialog with the students, in order to pull the trigger of reflection. Another tutoring system is DI ALOG (Tsovaltzi & Fiedler, 2003), which exploits the artificial intelligence algorithms to use natural language and reflection arises from Socratic dialogues.

Besides dialogues, concept maps support learning through reflection. Cimolino et al. (2003) proposed the Verified Concept Mapper (VCM) system as an innovative way of creating concept maps. The innovation is consisted in students' verification about the concepts they deal with.

Van Joelingen et al. (2005) distinguished the reflection between "reflection-on-action" and "reflection-in-action", considering that the reflection-on-action corresponds to the evaluation at the end of the activity, while the reflection-in-action is a kind of monitoring the activity's progress. Manlove (2007) also used the distinction between reflection-on-action and reflection-in-action, as Schön (1991) had defined it. The reflection-on-action emerges from the requirement for summary and evaluation of the entire activity. On the other hand, by the reflection-in-action students monitor specific stages of the activity and reassign its' progress.

White et al. (1999) used the SCI-WISE agent based software, in which each agent has its role, trying to accomplish specific targets. Such agents are the Planner, Collaborator, Assessor, Inventor and Analyser. Their inquiry activities followed the cycle: Question – Hypothesise – Investigate – Analyse – Model – Evaluate. At the beginning, a question about a phenomenon is given to the students, who make a hypothesis, for investigation. Then, they analyse the results and start modelling. Finally, the results' evaluation accomplishes the cycle. At this last stage, students reflect on the entire activity, searching for their model's limitations.

## **ANALOGICAL REFLECTION**

At the reflection stage, educators ask the students to reflect on their own actions, in order to improve their metacognitive skills. As the students reflect, they reconsider their progress from the beginning and revise by appropriate scaffolding. If the students study an analogical model instead of the target domain, then the revision is more substantial, because they find out their errors through their own existent knowledge from the familiar source domain of the analogical model. The kinds of reflection, which appeared in the researches we reviewed above, are the self-reflection and the comparative reflection. We propose an alternative kind of reflection, the analogical reflection. Hence, we distinguish the reflection in three kinds (Figure 1), according to

where the students reflect on . First, in *self-reflection*, students reflect on their own actions (Schön, 1991). Second, in *comparative reflection*, students reflect on others' actions (Elbers, 2003). Third, in *analogical reflection*, students reflect on analogies, collating their actions with the analogical model's functions. During the collation, students are asked to correlate the source with the target.

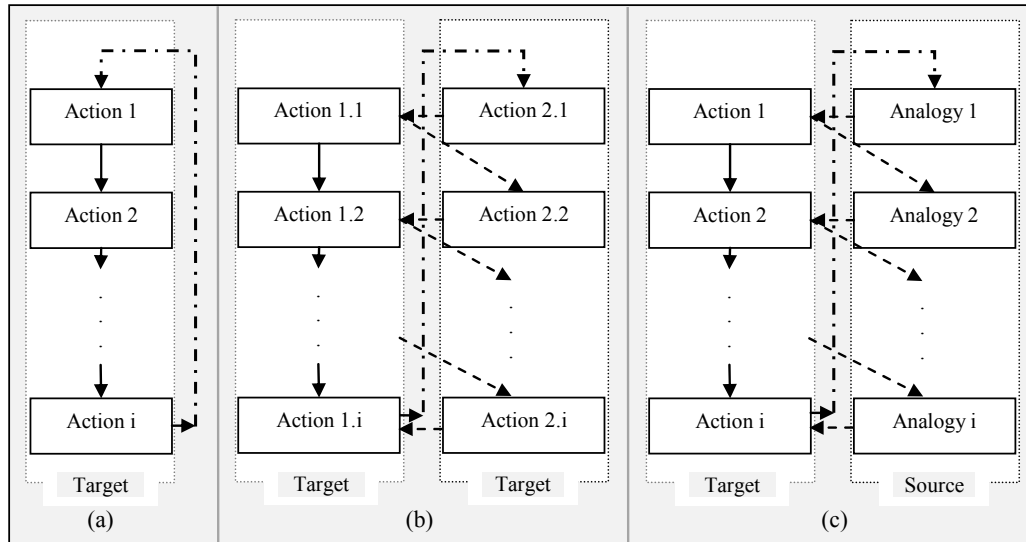


Figure 1. Kinds of reflection (a) self, (b) comparative, (c) analogical.

Our basic hypothesis is the following: In self-reflection, it is very possible that someone cannot recognise his/her own mistakes. In comparative reflection, this possibility is potentially reduced, because perhaps the others do not make the same mistakes. We estimate that this possibility is minimised when the analogical reflection is activated, because it is easier to recognise a strange behaviour in a familiar domain, where the normal behaviour is well known.

By the analogical reflection, students exploit their correct perceptions in revising the incorrect ones. The idea for introducing and examine the analogical reflection came from the state of the art and, specifically, from the combination of the analogical reasoning with the comparative reflection:

*Analogical Reasoning* } *Analogical Reflection*  
*Comparative Reflection* }

## RESEARCH

The scenario, which the students were dealing with, was the motion of a body moving towards the top of an inclined smooth plane. The body was shot by an initial impulse and then continued free. The aim of the scenario was the students to conclude to the Principle of Conservation of Mechanical Energy.

### Method

According to the inquiry cycle of White et al (1999), we propose the following inquiry modelling activity, enriched with the intermediate stage *analogical reflection*. In White et al. (1999), the reflection took place at the Evaluation stage. In our research, we tried to pull the trigger of

reflection at the Analogical Reflection stage, while at the Evaluation stage students explore the limitations of their models, as they have revised at the previous stage.

Question: *Which are the energy conversions, as a body moves towards the top of an inclined smooth plane?*

Hypothesis:  $\left. \begin{array}{l} \text{Decrease of speed} \Rightarrow \text{Decrease of kinetic energy (K)} \\ \text{Increase of height} \Rightarrow \text{Increase of potential energy (U)} \end{array} \right\} K \rightarrow U$

Investigation: *Study a simulation to discover the relations among the involved magnitudes.*

Analysis: *Study given graphs that describe the motion.*

Modelling: *Creation of a model in the educational, metacognition oriented, software ModellingSpace.*

Analogical Reflection: *Detection and description of the analogies between the created model and a given analogical model.*

Evaluation: *Detection of the created model's limitations, through other conditions (e.g. rough instead of smooth plane). In such case, the model and the analogical model shall be reformed, in order to fit the new conditions. This is the new question, from which a new inquiry cycle opens.*

Based on the above pattern we designed a pilot research, which is a case study on three groups consisted of two students each. The students worked collaboratively in the ModellingSpace. The target of our research was to study the contribution of analogical reflection in metacognition, compared with self-reflection and comparative reflection. Below, we outline the Modelling and the Analogical Reflection stages.

### **Modelling stage**

The modelling activities took place in the ModellingSpace (Dimitracopoulou et al., 1999) technological environment. ModellingSpace has been designed and developed to support modelling based collaborative learning in a wide spectrum of domains (Science, Maths, Social science, Economic science). Some examples of Interaction Analysis tools, during and at the end of the activities, of the ModellingSpace are given below.

- |   |   |  |
|---|---|--|
| <ul style="list-style-type: none"> <li>▪ History of messages.</li> <li>▪ Indication of the active participant's name (the one who acts on the common modelling workspace).</li> <li>▪ Collaborative Activity Function (CAF) graph. It counts the number of messages per participant. The educator may choose any combination of participants and compare their activity.</li> </ul> | } | <p><i>During the activities</i></p>        |
| <ul style="list-style-type: none"> <li>▪ Hold-down key percentages per participant.</li> <li>▪ Inserted entities and relations in the common workspace.</li> <li>▪ Actions like insertions, deletions, messages.</li> <li>▪ Complete history of messages.</li> <li>▪ Playback video.</li> </ul>   | } | <p><i>At the end of the activities</i></p> |

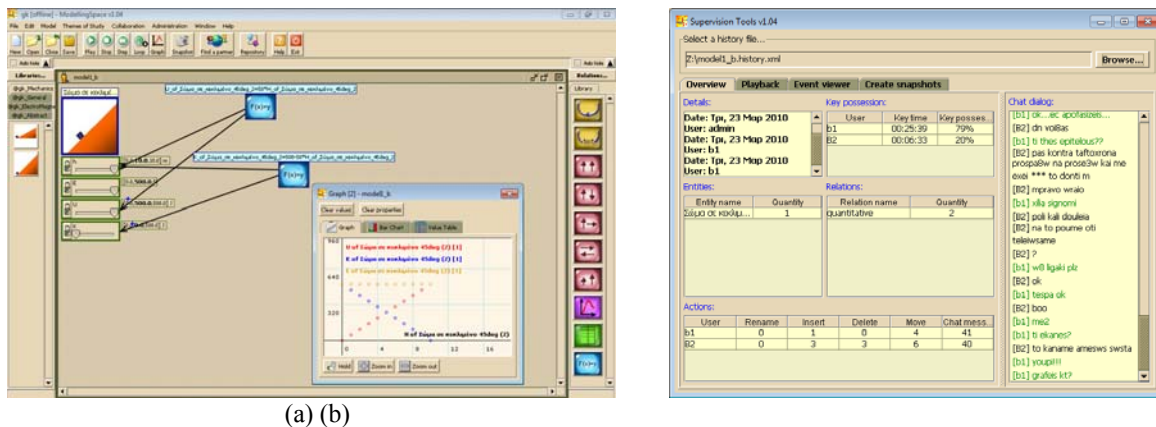


Figure 2. ModellingSpace's interfaces. (a) Modelling and Communication workspace, (b) Metacognition workspace (Interaction Analysis tools).

There are two workspaces (Figure 2). First, the Modelling and Communication workspace, where students design their models, supported with representation tools (simulation, graphs, tables), and communicate in a chat space (if students work collaboratively). The second one is the Metacognition workspace, where students utilise the Interaction Analysis tools.

### Analogical Reflection stage

The reflection mode we chose was the reflection-on-action, hence, students were asked to reflect only at the end of the activities. Right after they had finished with the model design (Figure 2a) we provided them an analogical model (Figure 3), created in the ModellingSpace. That analog represents the water transfusion from one container to another. Its visualisation shows the water that goes out of the one container gets in the other one. Therefore, if a third container represents the total water in both containers, its water level should be constant.

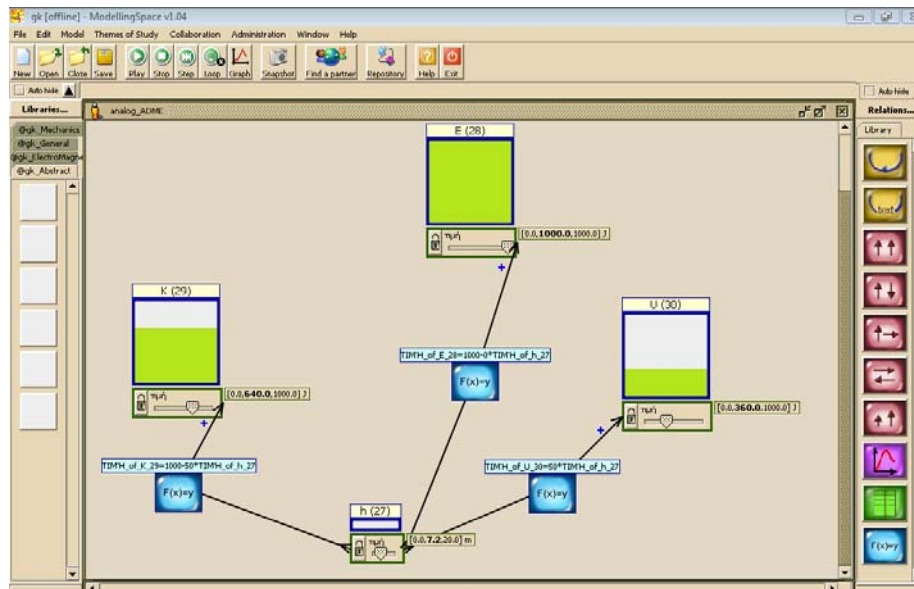


Figure 3. Analogical model in the ModellingSpace.

The students of the first group (A) were not involved with analogical reasoning, because we wanted them to reflect on their own actions (self-reflection). The second group (B) had to reflect both on their actions and on the answers of group A (comparative reflection). To the third group (C), we provided the water transfusion analog, in order to reflect analogically. At first, we did not explain how the analog works and asked them to find out its functionality (the containers had no captions above). Then, we captioned the containers and explained the analog's functionality. Namely, we explained how the analog "works" and which container corresponds with each type of energy (kinetic, potential and mechanical). By this way, group C reached the analogical reasoning through external scaffolding and then reflected analogically.

## Results

At the end of the Modelling stage, we asked the students to reflect, answering a questionnaire form and then discussing with their teacher. The main target of the questionnaire was the argumentation of the created model by the students. In this pilot study, we tried to discover the difficulties in reflection combined with analogical reasoning, in order to design a respective tool. Therefore, we did a qualitative analysis of the results. At the next research, which we are preparing, we will develop a quantitative measurement in order to test the tool (ART) we are designing.

The results showed that group A (self-reflection) had difficulties when documenting their model. The Interaction Analysis tools helped them to review what they had done, but they were unable to express why the model was working correctly. The only prove they mentioned was the energy-height graph, which was correct according to the theory (given at the beginning of the activities). For example, as they mentioned, "*Our model is correct because its graph is as we expected according to the theoretical one. The kinetic energy is decreasing while the potential is increasing. The mechanical energy is constant*". On the other hand, group B was helped by the comments (right or wrong) of group A. At first they claimed, "*We noticed that as the body was moving upwards, the kinetic energy was decreasing while the potential was increasing*". Then, considering the answers of group A, group B went deeper in explanation, noticing "*As the graph shows, the kinetic energy reduction is in every height equal to the potential energy increment. That's why the mechanical energy remains constant*". Finally, group C appeared as the most accurate in their documentation. They explained exactly the mechanism of the energy conversion and mechanical energy conservation. In addition, they resembled their model with the water transfusion analog. As they described, "*The water transfusion analog has similar functions with our model. The water is transfused from one container to another, like the kinetic energy is converted to potential*".

According to the results of group C, scaffolding is determinant for analogical reflection. Even group C documented correctly the energy conversion from kinetic to potential, however, they could not find out the analogy of the third container and, therefore, they did not conclude to the mechanical energy conservation. As they noticed, "*the third container doesn't do anything, it is stationary*". After we explained that the third container was representing the sum of the two other containers, the students responded, "*So, this is like the mechanical energy! That's why its level remains constant. Mechanical energy remains constant too*". Then, we captioned the three containers with the letters K, U and E, according to the kinetic, potential and mechanical energy.

To go deeper in to reflection, we asked the students to guess what would happen, in point of energies, if friction were present (rough plane). Parts of the dialogues with each group were the following:



- Group A: "The body will stop earlier, hence the kinetic energy will end earlier."
- Teacher: "Right. What about the potential and mechanical energy?"
- Group A: "At the highest point, the potential energy will be equal to the kinetic energy at the lowest point. The mechanical energy will be equal to the potential."
- Teacher: "As you say, the only change is how fast the energy conversion will happen, right?"
- Group A: "... Yes..."

-----

- Group B: "Part of the kinetic energy will be converted to heat. Therefore, the mechanical energy will be less."
- Teacher: "OK. Now, let's have a look at the opinions of group A. What do you think? Are they right?"
- Group B: "Group A claimed: 1) The body will stop earlier. Yes, that's true, we didn't think about it. This also means that the energy conversion is faster now. 2) The mechanical energy is equal to the initial kinetic energy. This is wrong, because, part of the kinetic energy will be converted to heat."
- Teacher: "So, the energy conversion will be faster and the mechanical energy will be decreasing."
- Group B: "Yes, it will be decreasing until the body reach the highest point and stop."

-----

- Group C: "The friction will cause mechanical energy reduction. Therefore, the body will stop at a lower point than before (smooth plane)."
- Teacher: "Right. Now, is the analog, which we gave you, still analogical to these new conditions? If no, how would you reform it to be analogical again?"
- Group C: "No, it's not any more... The E container should be losing some water, as the water is transfused from the K container to the U container. Also, the same volume of water must run out of the container, it won't get into the U container."
- Teacher: "Do you have any idea-trick how to do this?"
- Group C: "..."
- Teacher: "What about a hole somewhere high, but not highest, at the E container?"
- Group C: "... Yes!"
- Teacher: "I think we should make another hole at the K container. But where would you place it?"
- Group C: "... It should be at the lowest point; otherwise the K container won't be empty completely!"

Group A could not find out the energy conversion, from mechanical to heat. They pointed only at the kinetic energy conversion rate, which was greater comparing to the smooth plane conditions. Group B, at first found out the mechanical energy reduction. After reflecting on the comments of group A, they also realised the kinetic energy conversion rate's increment. Group C appeared again as the most accurate in their documentation, especially when scaffolding was present.

## CONCLUSIONS

One of the basic subjects, which educational technology researchers study, is the components that enhance metacognitive skills. Analogical reasoning can enforce the reflection, as a booster of metacognition. In the analogical reasoning stage, students exploit their knowledge in a familiar domain (source), in order to understand an unfamiliar domain (target). The researches on reflection are based, mainly, on the dialogues between educator and students. The dialogues conclude questions about the progress of the students during an activity and about the validation of their results.

In most of researches, the technological environments are based on artificial intelligence using a student model, which is either opened (Tsaganou et al., 2004) or closed to the students. Reflection may arise from the students' own ideas or from others' (classmates, teachers, software) ideas (Manlove, 2007). Besides student model, other artificial intelligence tools boost the reflection, such as Socratic dialogues (Tsaganou et al., 2004; Tsoultzi & Fiedler, 2003), software agents (White et al., 1999) and concept maps (Cimolino et al., 2003).

In our work, we presented briefly an instructional framework, in which students were asked to reason analogically and reflect on modelling activities, in order to exploit and improve their metacognitive skills. We introduced this kind of reflection and called it *analogical reflection*, discriminating it from self-reflection and comparative reflection. We assume that the students' errors may be recognised easier by the analogical reflection than by the other two kinds of reflection. Our hypothesis is based on the state of the art and, specifically, on the composition of the benefits of the analogical reasoning and the comparative reflection.

According to the results of our pilot study, when students reason analogically, especially when proper scaffolding is present, they reach exceedingly the metacognition level through reflection (analogical reflection). Without scaffolding, students have difficulties in analogical reasoning. Thus, the major outcome is that there is a need for a scaffolding tool, assisting students to reason and reflect analogically.

In order to examine deeper our hypothesis and confirm our results, we are designing a software tool that supports analogical reflection. The tool is called ART (Analogical Reflection Tool, Figure 4) and is going to be a mapping tool, assisting students while reflecting analogically. Closing, we cite an Oscar Wilde's quotation that accentuates the reflection's value and, on the other hand, brings to light the handicap of self-reflection.



Figure 4. ART's splash screen.

*I like to hear myself talking. It is one of my greatest pleasures. I often have long conversations all by myself, and I am so clever that I sometimes do not understand a single word of what I am saying.*

Oscar Wilde

## REFERENCES

- Cimolino L., Kay J. & Miller A. (2003). "Incremental Student Modeling and Reflection by Verified Concept-Mapping", *Proceedings of AIED2003*, July 20-24, Sydney, Australia, pp. 219-227.
- Dimitracopoulou A., Komis V., Apostolopoulos P., & Politis P. (1999). "Design principles of a new modelling environment for young students, supporting various types of reasoning and interdisciplinary approaches", *Proceedings of AIED1999*, Le Mans, pp. 109-120.
- Elbers E. (2003). "Classroom Interaction as Reflection: Learning and Teaching Mathematics in a Community of Inquiry", *Journal of Educational Studies in Mathematics*, Vol. 54, No 1, pp. 77-99.
- Harrison A. (2002). "Analogical Transfer – Interest is Just as Important as Conceptual Potential", *Annual meeting of the Australian Association for Research in Education*, Brisbane, 1-5 December 2002.
- van Joolingen W., de Jong T., Lazonder A., Savelsbergh E. & Manlove S. (2005). "Co-Lab: research and development of an on-line learning environment for collaborative scientific discovery learning", *Computers in human behavior*, Vol. 21, No 4, pp. 671-688.
- Manlove S. (2007). *Regulative Support During Inquiry Learning with Simulation and Modeling*, Doctoral Dissertation, University of Twente.
- Meyer C. (2002). "Hypermedia Environment for learning concepts based on inter-domain analogies as an educational strategy", *Proceedings of 6<sup>th</sup> International Conference on Intelligent Tutoring Systems*, Cerri S., Gouardères G. & Paraguaçu F. (Eds.), Springer, pp. 281-290.
- Schön, D. (1991). *The reflective practitioner*, 1st ed, Aldershot, Hants England: Arena Ashgate Publishing Limited.
- Tsaganou G., Grigoriadou M. & Cavoura Th. (2004). "W-ReTuDiS: a Reflective Tutorial Dialogue System", *Proceedings of ETPE2004 "Information and Communication Technologies in Education"*, Athens, pp. 738-746.
- Tsovaltzi D. & Fiedler A. (2003). "An Approach to Facilitating Reflection in a Mathematics Tutoring System", *Proceedings of AIED2003*, 20-24 July, Sydney, Australia, pp. 278-287.
- White B., Shimoda T. & Frederiksen J. (1999). "Enabling Students to Construct Theories of Collaborative Inquiry and Reflective Learning: Computer Support for Metacognitive Development", *Journal of Artificial Intelligence in Education*, Vol. 10, No 2, pp. 151-182.

### 3.7 – Learning out of school

---

# **Babies' Response To Magnetic Interaction: An Exploratory Study**

M. Celia Dibar Ure  
Instituto de Ciencias, Universidad Nacional de General Sarmiento  
Argentina  
[celiadibar@yahoo.com](mailto:celiadibar@yahoo.com)

María Alejandra Aleman  
Instituto de Desarrollo Humano, Universidad Nacional de General Sarmiento  
Argentina  
[alea\\_ar@yahoo.com](mailto:alea_ar@yahoo.com)

## **Abstract**

In this paper we present an exploratory study about babies' reactions to interactions between magnets, as well as a discussion about teaching action at a distance in physics classes at different levels. We interviewed six babies aged between 5 and 10 months. Three of them showed surprise when a magnet pushed another magnet without touching it, while they remained uninterested when a box pushed another box by contact. This precocious behaviour was filmed and then described and analysed.

In this context, we consider the importance of teaching magnetism to children, adolescents and young adults. We also discuss the case of gravity, usually taught to all students in elementary physics at various levels. Because of its characteristics, it is much more difficult for students to associate gravity and its effects to an action at a distance.

## **Introduction**

Babies' reaction to film simulations of action at a distance (Leslie, 1984) was one of the examples of behaviours considered "surprisingly precocious". It was discussed during the 90's, in the context of the development of perception of causality, together subjects central to cognitive development like oral language and "theory of mind" (Karmiloff-Smith, 1992). One question raised at the time was whether they might be indications of some form of innate "restrictions" which might help the baby make sense of the enormous amount of information received from the world he was born into. In the case of language it would be useful for communicating with other human beings, in the case of "theory of mind" for interpreting fellow beings' actions, and in the case of not expecting actions at a distance (Leslie, 1984; Cohen and Amiel, 1998) for making sense of interactions in the surrounding physical world.

The existence of innately favoured cognitive phenomena is currently being questioned (Karmiloff-Smith, 2009), while new and interesting discussions about what is innate and what is learnt are coming to light related to evolution of the mind and to cognition in animals (Finlay, 2007; Hauser et al, 2002).

The experiences for the study of causality were done using filmed animations of simulated bodies interacting by contact or at a distance. In these studies, it took the babies some time to get used to the situation of watching the movies in a darkened room and in a non familiar atmosphere.

## Interviews

In our work we were interested in the subject of magnetism and action at a distance from the point of view of learning and teaching physics, as well as in the discussion of the precocity of the babies' reactions.

We carried out an exploratory and qualitative study (Hopkins, 1989; Glaser and Strauss, 1967) involving few case studies. This way of working allowed us to make decisions and carry out small changes that would benefit the observations as we went along.

We decided to interview babies, using concrete material as is done in work like that carried out by Kutosky and Baillargeon (1998) rather than using two dimensional objects drawn in films that were shown in a darkened room like the settings used in former studies on the subject of causality which included simulated interactions at a distance (Leslie 1984; Cohen and Amsel 1998).

We decided to focus on the babies' reactions to the event shown rather than to measure only the times during which they looked. Measuring times is essential for smaller babies (3 to 4 months old) (Spelke 1990) as it is the only interpretable reactions of their interest. But we will show that babies over 5 months like the ones involved in this and other studies (Leslie 1984; Kutosky and Baillargeon 1998) have strong and more complex reactions to show their interest.

We interviewed 6 middle class babies: 2 boys and 4 girls aged between 5 and 10 months, The interviews lasted about 7 minutes and they were videotaped.

They were carried out either at the babies' homes or at the university (Universidad Nacional de General Sarmiento, in the outskirts of Buenos Aires) where their mothers worked and where they attended a nursery. Thus the settings were very familiar to them.

The babies were seated on their chairs, beside their mothers or on their lap. In the last situation, after the first trial, we asked the mothers to close their eyes so that their reactions would not influence the babies.

We focalized the analysis on the babies' reactions through their gestures, attitudes and the time they looked at two type of situations:

Event i)- a box pushing another box (by contact)

Event ii)- a magnet pushing another magnet (at a distance)

This sequence was repeated 2 or 3 times for each baby. So each interview consisted of at least 4 events (Boxes – Magnets – Boxes – Magnets).

Then they were classified by 2 independent judges who were not familiar with the research.

As judging reactions, gestures and even duration of events could be subjective part of the film was covered and the order of the sequence (box- magnet) was altered so the person judging couldn't associate the babies' reactions to which event was being shown.

The agreement between the 2 judges to the babies' reactions to every situation shown was 100%.

## Results and discussion

Three of the babies reacted differently to at least one of the events involving interaction of the magnets than to that of the boxes.

Baby boy *Sa*, who was 7 months and 25 days old at the time of the interview, looked longer and more intently at the magnets than at the boxes.

*Lau*, a baby girl, 7 months and 8 days old, not only looked longer, but she also leaned towards the table and stared at the magnets.

Lar, another baby girl aged 9 months and 4 days, looked with only some interest at the box pushing another one and then raised her arms, in a rudimentary applause, and gave a little cry when one magnet pushed the other one without touching it.

We illustrate these reactions with photographs of two of the children for each of the two situations.



**Figure 1:** Lar looks when one box pushes another one.



**Figure 2:** Lar reacts with an “applause” when one magnet pushes the other one without touching it.



**Figure 3:** Lau looks when one box pushes another



**Figure 4:** Lau looks intently when one magnet pushes the other one without touching it

These are interesting reactions if we question ourselves: why would a baby show surprise? Are 7 to 9 months enough time of a baby’s contact with the world to learn not to expect actions at a distance between everyday objects? Or must there exist SOME innate “facilitation” to explain this restriction?

Discussing this exploratory experience seems promising on two accounts.

From a cognitive point of view it obtains the same surprising results that previous papers but with a very different methodology, where a baby can be observed in all his reactions in a natural setting and with concrete material.

From the point of view of Physics teaching, a complex discussion about teaching action at a distance can be raised. We will attempt a brief introduction in the following section.

## **In relation to Physics Teaching**

Magnets which interact at a distance precociously surprise babies <sup>1</sup>, but they also fascinate children who immediately want to play with them. They are very tempting to handle for any adult who has a few at hand.

Children and adolescents may have learnt about magnets through varied sources (toys, Internet, magazines, classes, TV, etc).

Although this is not so in many countries, in Argentina it is hardly ever studied in primary school and when it is, usually no experimental activities are done. However a very high percentage of children know that magnets interact at a distance before having had any high school physics classes (Dibar et al, 2009).

A year after having done one laboratory class on magnets, secondary school students remembered much more than students usually do about labs about other subjects (Dibar and Aleman 2010; Petrucci 2006).

These results point to magnetism as a very special subject to work with in physics within the broader theme of action at a distance. We would like to make a point that magnetism, especially with laboratory experiences should be studied early in school and certainly before other interactions at a distance like gravity are studied.<sup>2</sup>

However, it is gravity that is usually taught first in a systematic way in most curriculums of elementary Physics at different levels, as if its constant presence in everyday life were helpful to understand it. Absolutely the opposite may be happening.

Understanding gravity and its effects can be a complex task. One of the reasons is that we are too familiar with it. Children take its effects for granted: if nothing holds it an object falls. "Falling" is one of the words they use to describe everyday physics (Ogborn, 1985). We live in a world where gravity affects everything and it cannot be eliminated. To make it more complicated, its effects cannot be observed as an interaction between bodies of a size we can manipulate (Dibar y Pérez, 2007).

Later on, when students are taught the Newtonian explanations they are difficult to accept and strongly un-intuitive: the weight is a force that results from an interaction at a distance with a body whose size and permanent presence make it, paradoxically, invisible.

At the same time, if secondary students are asked to choose from different explanations for the force of gravity, several of which are correct, many choose an answer which states that the cause of gravity on earth is the existence of a magnet at the centre of the earth (Dibar et al, 2009). These results stress the importance that magnetic forces have for them, probably related to the early interest to action at a distance. This explanation given by adolescents is not so surprising. It is interesting to mention that among other hypothesis to explain the causes of planetary motion, Kepler included the idea of a kind of magnetic attraction and repulsion between the sun and the poles of the planets (Koyré, 1973; Holton, 1956). Kepler based this idea on a former work by Gilbert which characterizes the earth as a giant magnet.



<sup>1</sup> Babies are interested in an object that moves without being touched. The fact that magnets were chosen are a characteristic of their stability and relatively easy manipulation which makes them such a good choice for laboratory practices.

<sup>2</sup> We are aware that the bipolarity of magnets introduce complexities that we have not mentioned here.

## References

- Cohen, L. B. and Amsel, G. (1998), Precursors to infants' perceptions of the causality of a simple event. *Infant behavior and development* 21 (4), 713-732.
- Dibar, M.C; Aleman, M.A. y Montino, M. (2009), Aprendiendo sobre imanes, *II Jornadas de Enseñanza e Investigación Educativa en el campo de las Ciencias Exactas y Naturales Actas II*, La Plata, 10-17.
- Dibar Ure, M.C. and Perez, S.M. Análisis de las dificultades de los conceptos de peso y gravedad: algunos resultados de investigación desde un marco teórico neuroconstructivista. *Revista de Enseñanza de la Física*, 20 (1 y 2), 33-37.
- Finlay, B.L. (2007), E Pluribus Unum: Too many unique human capacities and too many theories In S. Gagenstad and J.Simpson (Eds): *The evolution of mind: fundamental issues and controversies*. NY. Guilford press.
- Glaser, B. y Strauss, A. L. (1967) *The discovery of grounded theory: strategies for qualitative research*. Chicago, Aldine
- Hauser, M., Chomsky, N. and Fitch, W.T (2002) The faculty of Language: What is it, who has it, and how did it evolve? , *Science* 298
- Holton, G. (1956) Johannes Kepler's Universe: Its Physics and Metaphysics, *Am.Jn, Phys.* 24, 340.
- Hopkins, D., Bollington, R. and Hewett, D.(1989) Growing up with qualitative research and evaluation. *Evaluation and research in education*. 3(2) 61 –79
- Karmiloff-Smith, A.(1992), *Beyond Modularity. A developmental Perspective on Cognitive Science*. Cambridge, Mass. MIT Press.
- Karmiloff-Smith, A (2009), Nativism vs Neuroconstructivism: Rethinking the Study of Developmental Disorders, *Developmental Psych*, 45 (1). 56-63.
- Koyré, A (1973), *The Astronomical revolution*, Hermann, Paris, Cornell University.
- Kutinsky, L & Baillargeon, R. (1998), The development of calibration-based reasoning about collision events in young infants. *Cognition*, 67, 311-351.
- Leslie, A (1984), Spatiotemporal continuity and the perception of causality in infants, *Perception* 13, 287-305.
- Ogborn, J. (1985) Understanding students' understandings: An example from dynamics. *European Journal of Science Education*. 7 (2). 141-150.
- Petrucci, D., Ure, J. y Salomone, H (2006) El rol de los trabajos prácticos de laboratorio en cursos universitarios de física.
- Spelke, E. (1990) Principles of object perception. *Cognitive Science* 14, 29-56.

# Four Enhanced Science Learning Dimensions: The Physics & Industry Programme

Dorothy Langley,<sup>1,2</sup> Rami Arieli<sup>1</sup> and Bat Sheva Eylon<sup>1</sup>

<sup>1</sup> Davidson Institute of Science Education & Department of Science Teaching, Weizmann Institute of Science, Rehovot, Israel;

<sup>2</sup>Holon Institute of Technology, Holon, Israel

[Dorothy.Langley@weizmann.ac.il](mailto:Dorothy.Langley@weizmann.ac.il)   [Rami.Arieli@weizmann.ac.il](mailto:Rami.Arieli@weizmann.ac.il)   [b.Eylon@weizmann.ac.il](mailto:b.Eylon@weizmann.ac.il)

*Corresponding author: Dorothy Langley, Langley@hit.ac.il*

**Abstract** The Physics & Industry program is an elective, out-of-school, accredited program for high school physics majors, who meet on a bi-weekly basis for 15 months. The program currently into its 7<sup>th</sup> cycle, with over 150 graduates, implements a project-based learning instructional approach. Student pairs, coached by industrial engineers, design and construct a working model providing a solution to an authentic, open-ended technological problem, employing principles of electro-optics. The instructional design of the program enhances four learning dimensions as a way of supporting and scaffolding students' efforts and guarding against the undermining effects of conflicting demands and natural attrition during the program: Learning to apply knowledge; Learning to use technological and cognitive tools; Learning to communicate; and Learning to become a member of a community. Our paper provides detailed examples of the activities employed in order to bring about the required knowledge enhancement and presents evidence of the effectiveness of the instructional design.

**Key words** Project-based learning, Extra-curricular program, Applying knowledge, Technological skills, High school physics,

## Introduction

Contemporary physics education faces the challenge of relevance to students' interests and future careers. Euler (2003) claims that "Physics education is challenged to prepare our students to cope with a world of increasing complexity". He suggests that "We have to find more appropriate ways to make physics meaningful to the learners...a positive development of students' interest can be fostered by adequately designed learning environments that focus on authenticity and practical experience."

Mioduser & Betzer (2006) show evidence that project-based-learning contributes favourably to the technological knowledge construction process by high-school high-achievers, and to their ability to design and implement solutions for technological problems, as well as a positive change in attitude towards technology and technological studies. Milgram (1999) shows that a strong relation exists between the focus of high ability adolescents' out-of-school activities and the field of their adult vocation.

Both the challenges and methods of facing them seem quite clear. The question remains whether the answer can be found within the traditional school system. High school physics education operates under many constraints, which prevent the implementation of instruction designed to face the above mentioned and other challenges. This lack is being addressed by academically-based science education centres (e.g. Markovich, 2004).

The Davidson Institute of Science Education provides long-term, accredited programmes for motivated, high-ability science majors. The *Physics and Industry* (P&I) program operates in close partnership with a world-leading electro-optics enterprise, to provide a technologically-focused, out-of-school learning environment. Successful completion of the program grants student 2 of the 5 credits required of physics majors. The 15 month program has been running in its present format since 2004 with over 150 graduates. The project-based program involves students in a variety of theoretical and technological activities leading towards the final product: a working model constructed by student pairs dealing with a real world problem accompanied by a detailed project report. We shall present four enhanced learning dimensions of the program, describe some of the related activities and provide evidence supporting the effectiveness of the instructional design.

### Learning to apply knowledge

The initial application range of students' physics knowledge is limited to standard text-book problems. Activities such as explaining observed phenomena, designing a specified system and determining physical features provide opportunities for enhancing the ability to apply physics knowledge.

#### Explaining observed phenomena

Research has shown that traditional instruction of Geometric Optics is often ineffective for enabling students to explain and predict optical phenomena related to image observation (e.g. Goldberg & McDermott 1986). Activities involving observation, exploration and theory-based explanation are intended to engage students mentally and physically in applying their formal knowledge. Fig. 1 shows two solid glass rods placed in transparent containers containing water and glycerol, respectively. The glass rod can be seen in the water but is invisible in the glycerol. When the glass rod is withdrawn from the glycerol it "re-appears".

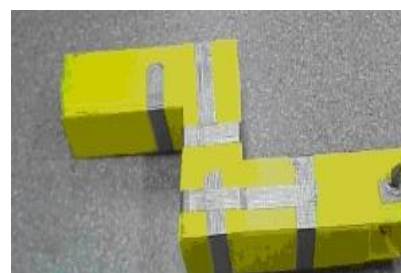


**Fig. 1** Why does the glass rod vanish in glycerol?

#### Designing a specified system

In the technological world, electrical, mechanical and optical systems represent physics knowledge based, designed solutions of real world problems. Students require practice in this form of knowledge application. This is achieved through instructional activities named "mini projects" (Langley, Arieli & Eylon 2006).

Mini-projects are short (3-4 hours), semi-structured activities. Student teams are required to design and construct a working system solving a given technological problem and to verify that their product conforms to the specifications. The mini-project worksheet contains the technological problem description, expected product performance, equipment specifications and available options and requirements for the detailed team report. For example the problem description of the "Seeing around obstacles" mini-project: Sometimes it is necessary to see around opaque obstacles or to see without being seen. Product specifications: 1. Create an upright image. 2. Allow the observer to see the image in the absence of a direct line of vision. Available equipment: 8x8 cm front reflecting plane mirrors, cardboard, adhesives, scissors, etc. Fig. 2 shows a sample product of the mini-project.



**Fig. 2** Sample mini-project product

#### Determining physical properties

Scientists and engineers apply physics principles to determine properties of components (e.g. resistance of a conductor, focal length of a lens or wavelength of light). Physics principles can also be used to calculate system variables such as distance to a target or velocity of an object. In contrast with end of chapter questions with given system data, our students are required to select a strategy, decide on the required data, perform the necessary measurements and carry out calculations, taking into account experimental error.

Fig. 3 shows the set up for measuring the focal length of a divergent lens. The students are given a set of 4 lenses (2 convergent, 1 divergent and a Fresnel lens), and are required to find their focal lengths within one hour. The worksheet refers to the relevant definitions and formulas and summarizes the different methods for determining focal length. The equipment trolley offers rulers, small light bulbs, paper screens, and metal optical benches to which the equipment can be attached by magnetic strips.

Finding the focal length of the divergent lens is the real challenge for which students need to integrate data with theory of lens' systems.



**Fig. 3** Measuring the focal length

#### Learning to use tools

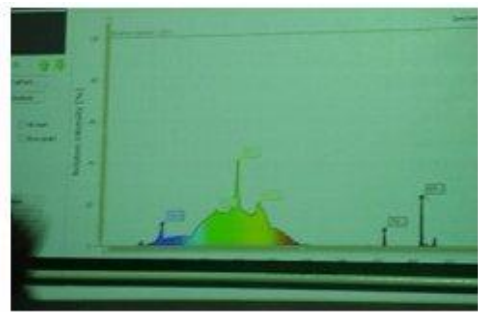
In view of the students' limited initial skills opportunities and modelling are provided for using common, as well as more advanced technological and problem-solving tools.

1. Basic technical tools, such as glue-guns, saws and screw-drivers (Fig. 4).



Fig. 4 Students using technical tools

**2. Physics' measurement instruments** including voltmeters, ohmmeters, power meters and computer-based measurement such as data-loggers and audio analysis software. Freely available audio analysis software (e.g. [Goldwave](#) or [Audacity](#)) is used to sample changes in light intensity. This enables measurement of high frequency phenomena and motion detection and analysis (Fig. 5).



Using different measurement tools to analyze light.

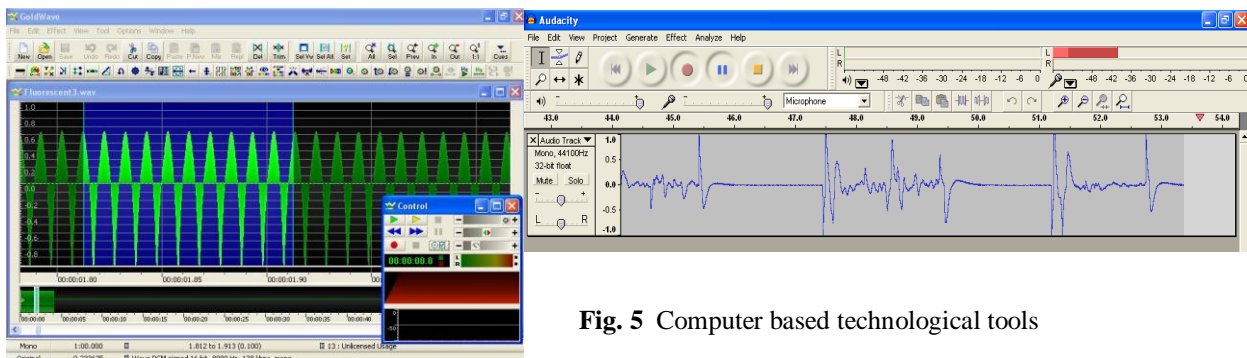


Fig. 5 Computer based technological tools



### 3. Cognitive tools

Software tools (simulations, spreadsheets, word processors and graphic software) facilitating visualization of systems and phenomena and extending cognitive abilities are employed. The [Visual Quantum Mechanics](#) and [PhET](#) simulation packages are used in several contexts. The Visual Quantum Mechanics simulation (Fig. 6) is used to help students relate observed spectral phenomena with the basic notion that light emanates from matter and the quantum nature of light.

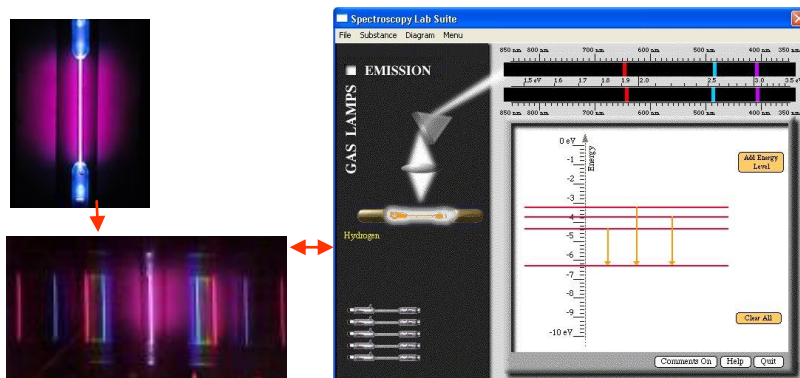


Fig. 6 Visual Quantum Mechanics simulation – Gas discharge lamps

**Systematic Inventive Thinking (S.I.T)** offers principles and strategies for inventing and designing original & successful solutions for technological problems. S.I.T problem solving involves several stages:

- **Imaginary stage:** Ideal world, free of practical constraints. Focus on what needs to be achieved rather than how it will be achieved. **Divergent thinking** employing the **Magic Elves'** strategy (Fig. 7).
- **Logical stage:** Systems' approach, sequencing, defining particular functions and requirements, optimizing.
- **Material stage:** Focus on how functions will be achieved, harnessing natural phenomena and science knowledge to achieve solution.
- **Practical stage:** Constructing a working model, considering engineering constraints, testing, verifying.

The "Magic Elves" are imaginary beings with unlimited abilities - within the laws of nature. There is an unlimited supply of elves and they have no physical needs. Different elves can perform different functions. However, they have no initiative of their own – they only do what the designer commands them to do.

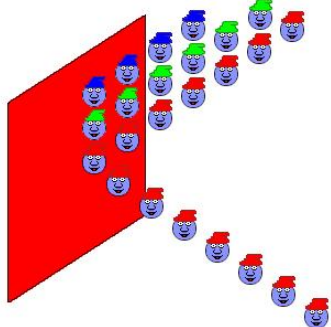


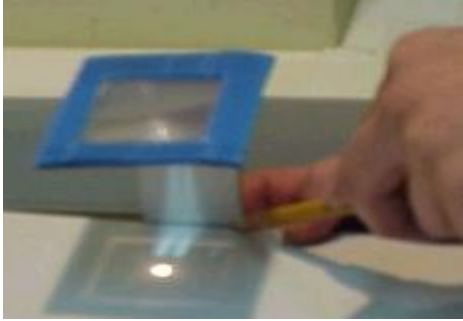

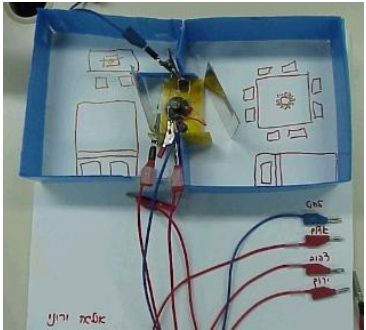
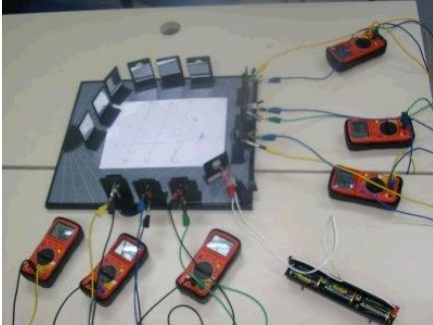
Fig. 7 Magic Elves representing RGB components of white light, hit a red material and only the R elves are reflected. Different solutions can be represented by different ways the G&B elves are subtracted from the incoming beam, or by different ways the R elves are re-created and emitted.

### Learning to communicate

The program provides many opportunities for verbal, oral and graphic communication. Some of the routine avenues involve accessing the program web site for information updates and posting messages, communicating with course leaders by email, and preparing and submitting experiment reports and homework assignments. Following are some detailed forms of exercising different communication modes.

*Photographically documenting events and systems* (Langley & Arieli, 2010) enables repeated viewing of the physical event, possibly from several angles, thus transcending the limitation of visual memory and promoting reflection. In the P&I program, digital photography is employed extensively, both by the course leaders and by participating students. Photography by course leaders is intended to model systematic documentation, promote

a sense of community, provide a quality photograph repository and collect materials for research and public relations. Digital photography by students (Fig. 8) facilitates documentation of experiment equipment for preparation of reports, and for future replication, documentation of experiment results, and project performance away from the lab, capturing what the eye sees in optical systems, documentation and tracking of project progress, preparation of graphic content for project report and homework assignments, capturing teacher explanations from the whiteboard, or from a mentor's sketch, communication with an absent partner, or distant mentor and finally documenting situations for personal satisfaction and future sharing with peers and family.

<p>Measuring focal length of a Fresnel lens.</p> 	<p>Student capturing the set up for a triangulation measurement.</p> 
<p>Capturing the product of the illumination mini-project. A mixture of actual apparatus, and diagrammatic representation, of two rooms with different lighting requirements.</p> 	<p>Demonstration set up of a basic model for detecting an intruder into a secure area, using a laser beam, a diffraction grid, plane mirrors and solar cells connected to voltmeters.</p> 
<p align="center"><b>Fig. 8</b> Photographic documentation of technological set ups</p>	

*Preparing, presenting and evaluating posters*

About 6 months into the P&I program, students participate in a "poster session", during which they present and defend their initial ideas for their projects (Fig. 9a and 9b). The poster presents information about the team, project topic, technological problem context, requirements of the future solution, functions that need to be performed in the system, and 7-10 Magic Elves' solutions utilizing SIT principles .



**Fig. 9a** Students setting up their posters



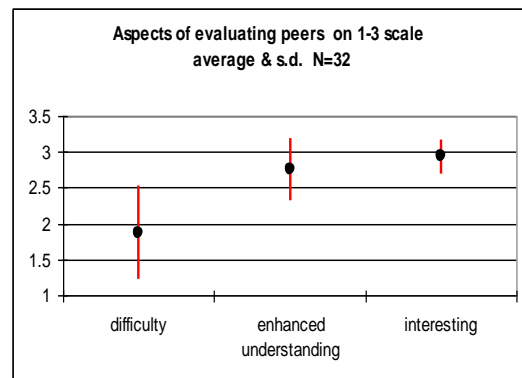
**Fig. 9b** Presenting poster and defending ideas during the peer and expert evaluation phase.

Following are some results of the 2010 poster session questionnaire (N=32). The results (Fig. 10a, 10b) indicate that students considered the poster presentation event beneficial both motivationally and cognitively.

Aspects of evaluating peers

(1=very little, 2= to a certain extent, 3=greatly)

- It was difficult to evaluate peers' work.
- The evaluation enhanced my understanding.
- It was interesting to view projects and models.

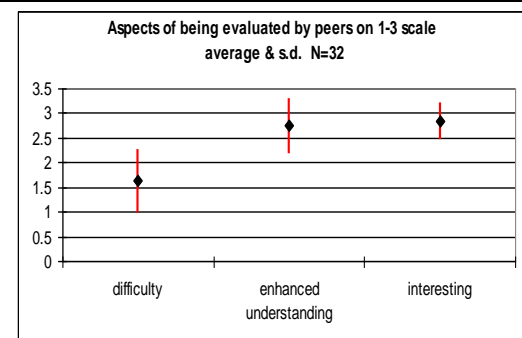


**Fig. 10a** Students attitudes towards evaluating peers

Aspects of being evaluated by peers

(1=very little, 2= to a certain extent, 3=greatly)

- It was difficult to present my project and models.
- Presenting my poster enhanced my understanding.
- It was interesting to explain my project and models.



**Fig. 10b** Students attitudes towards being evaluated by peers

*Presenting products to peers and experts* occurs several times during the program e.g. mini-projects and initial models (Fig. 11). Each team describes the technological problem it has addressed, the principle behind their product, the set up and components and finally demonstrate that the product

fulfils the requirements and has various merits. Members of the audience pose questions to which the team responds. Peer-evaluation of the presented products is carried out on distributed forms and the results are conveyed to each team.



**Fig. 11** Presenting projects

#### *Explaining the project to internal and external evaluators*

The evaluation sessions requires the project team to define the problem, describe the physical context and its requirements, explain the physical principles employed, demonstrate the functioning of the model and explain the role of each component. Finally, the team evaluates the model and suggests improvements. For the external evaluation the teams often prepare a power-point presentation, to which they may refer during the oral exam (Fig. 12).



**Fig. 11** Explaining to evaluators

#### *Composing a project report*

The project report consists of an executive summary and a detailed report explaining the technological problem in context, the development process of the model starting with the imaginary Magic Elves, and progressing through the different stages until the final model. The physics principles involved in the project are explained as well as the experiments that were carried out in selecting the components. The report also includes a reflective summary in which the project team defends and critiques the decisions taken, and suggests improvements of the final product.

Students' comments indicate that producing a lengthy, structured report is a unique experience of which they are very proud.





Interacting with professionals

Fig. 13 Interacting with professionals

### Learning to become a member of a community

The P&I participants, who come from different schools, are helped to develop a sense of belonging to an "elite" community. The students meet and collaborate with professional adults at work (academic teachers, doctoral students, technicians, engineers and scientists), as well as with P&I graduates studying for engineering degrees (Fig. 12). The program is organized around 6 events, each marking a milestone along the road from novice participant to accomplished graduate: opening ceremony, tour of a high-tech industry, poster session, initial model presentation, final evaluation and graduation ceremony. The sense of belonging is reinforced by the within-team and inter-team interactions, and the shared photo repository.

The strong partnership with the leading Electro-Optics industry is consolidated through invited lectures, a tour of the plant and coaching by the engineers.

### Supporting evidence for the instructional design

1. Students successfully construct the working models they designed. The average grades on the final external examination are above 90%.

Program year	Graduates	Projects	Radiation & Matter unit	Lab unit
2004-5	28	15	95.7	97.1
2005-6	12	7	97.4	98.5
2006-7	21	12	94.7	96.3
2007-8	24	12	94.5	96.4
2008-9	21	12	94.0	95.1
2009-10	24	12	94.6	99.0

A variety of examiners have commented favourably about the high level of the products and the level of scientific discourse students displayed.

2. After the initial settling period, 80% of the group persevere and complete the program. This is a non-trivial achievement since the students are not relieved of their school physics duties up to the final evaluation and could gain the same credits at school. Also participation in the program involves payment, self-transport and investment of considerable time over a long period.
3. Positive reflective testimonials by students, teachers, engineers and examiners

Student testimonials in the project report reflective paragraphs indicate the awareness of the programs benefits:

- *The program helped us understand more genuinely what physics and its application meant. We were able to emerge out of the school routine of lessons and books to which we were accustomed.*
- *We learnt how to apply our knowledge. We learnt how to integrate knowledge from different domains. We learnt how to overcome criticism and become more creative.*

#### Teacher Views

Over the past 6 years, we have repeatedly seen that the physics teachers enthusiastically encourage their high ability students to join the program and persevere in it. Teachers comment on the added-value the program contributes to students' knowledge, skills and confidence.

#### Leading engineering industry support

The P&I program (in its various forms) has been supported by El-Op, a world leading electro-optics industry. This support, which indicates the value the high-tech industry attributes to the program, is manifested in many ways including participation of engineers in the project coaching process, opening the plant for a structured guided tour, and responding favourably to requests for lectures.

4. Mid-program reflective questionnaire affirms students' satisfaction with the program components. Following are some results for our 2010 cohort (n=32).

#### a. Overall impression

Overall I am satisfied with participating in the program. According to my impression so far I would recommend participating in the project to my friends.

4=strongly agree, 3=quite agree, 2=quite disagree, 1=strongly disagree

Results: Average= 3.4, s.d.=0.62

#### b. Satisfaction with various aspects

Aspect	average	sd
Geometrical Optics content	3.3	0.8
Electro-optics content	3.0*	1.3
SIT content	3.7	0.5
Technical support	3.5	0.7
Staff attitude	3.5	0.6
Atmosphere	3.7	0.5
Variety	3.3	0.8

The data indicate a widespread, high degree of satisfaction with the main aspects of the program (table 2).

The low rating for electro-optics was related to little exposure at that stage.

#### c. Favoured activities

Rank	Activity
A (top)	Experiments
B	Tour of industry, Poster preparation and presentation
C	SIT, Team work
D	Project topic lectures, Demonstrations, Learning theory
E	mini-projects, computer based lab, Project design

The data show the preference for hands-on and minds-on activities (table 3).

#### d. Effect of program aspects on knowledge development

4=very large, 3=quite large, 2=quite small, 1=very small

Knowledge development factors	average	s.d.
Application of physics principles	3.6	0.62
Demonstrations	3.3	1.06
Computer simulations	2.9	1.07
IT communication	3.1	0.98

The data indicate that students considered the applicative, practical aspect of the program as having the main impact on knowledge development (table 4).

## 5. Long term effects

Over the past 6 years we have gathered consistent (if anecdotal) evidence about the long term effects of the P&I program:

- Recent-graduates respond positively to the request to take part in evaluating the new class's posters. We are impressed with the seriousness and knowledge they display as they pose questions and suggest changes.
- Graduates who are studying for university engineering degrees return to act as project coaches.
- Graduates continue communicating with the project leaders about innovative technological ideas they have.
- Exceptional graduates are accepted as research assistants with leading scientists or are placed in prestigious positions in their army service.
- Family ties: so far 8 younger brothers or sisters joined the program following their older siblings.

## 6. Graduate survey

During 2011, a phone survey was conducted amongst a small sample of the graduates of the 2004-2010 Physics and Industry classes (14 males and 5 females). 7 graduates were engaged in academic studies after their army service; 8 were in the army (conscription and regular service); one was working at the science park after his army service; and 3 were still in high school.

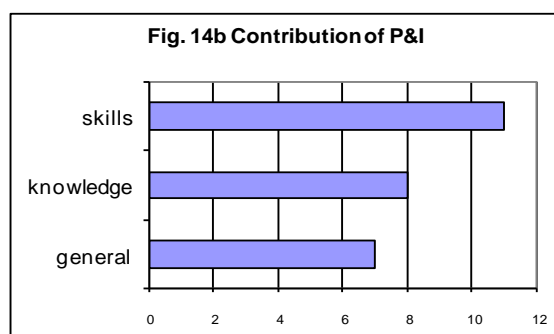
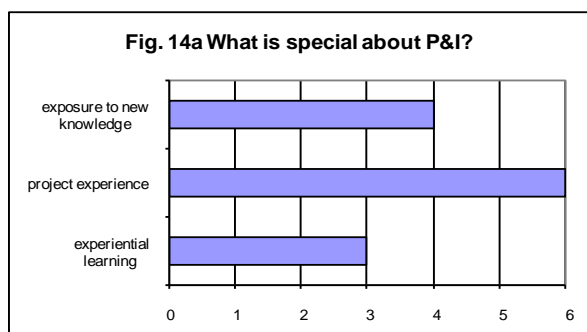
### • Reasons for joining the program

The main attraction was the content that sounded more interesting than the regular school physics. Over half the sample stated that the main motivation was the interest and love of the subject. The challenges the program presented was also mentioned. Creditation was mentioned by 21% as additional motivation.

### • Contribution of the program

The graduates were satisfied with their choice and the effort they had invested in completing the program. 15 of 19 stated they would recommend participation to their friends. All the graduates mentioned extension of theoretical and practical physics knowledge (Fig. 14b). They also mentioned the acquisition of a variety of skills such as project management, problem solving and hands-on scientific inquiry skills (Fig. 14a). The acquired knowledge and skills had proved useful for their future academic and military careers. The change in cognitive thinking patterns following the Systematic Inventive Thinking course was considered a major contribution by all the graduates.

The program contributed to helping students define their academic identity and future. 8 stated they would study physics and engineering and another 3 selected medicine. The encounter with the practical side of physics along with the face to face interaction with industry and engineers, scientists and advanced degree students opened a window into the worlds of industry and academy. This is an experience not open to many high school students.



- Main difficulties

Most of the interviewees did not remember or mention any particular problems they had encountered. A few mentioned the pressure of assignments during the second year, because of the regular school work and the need to complete the project during the period of critical exams at school. A few graduates pointed to the unsatisfactory support by the course leaders and problems with partners leaving. Some of the interviewees would have liked better social bonding with other participants.

### Summary

The P&I program represents an instructional framework created to address the challenge of extending the learning experiences of high-ability, high school physics majors towards the realm of technological applications of knowledge. It conforms to the model of a learning environment that fosters the productive use of acquired knowledge and skills since it "confronts students with challenging, realistic, problems and situations that have personal meaning for them and are representative for the kind of tasks they will encounter in the future" (De Corte, 2003). It also displays several of the desired attributes of science learning environments proposed by Euler (2003):

- Getting in touch with science and technology in the work place.
- Personal contact with students and scientists.
- Creating opportunities and stimulating environments to interact with authentic problems from science and technology that pose a certain degree of challenge.
- Working on problems that show cooperative and collaborative aspects of projects in science and technology.

The described instructional design has been developed over the past 7 years, and it will continue to evolve in response to additional challenges such as dealing with the recruitment and perseverance of female students and the integration of advanced technologies.

### References

- De Corte, E. (2003). Designing learning environments that foster the productive use of acquired knowledge and skills. In E. De Corte, L. Verschaffel, N. Entwistle, & J. van Merriënboer (eds.) *Powerful learning environments: Unravelling basic components and dimensions* (21-33). Oxford, UK: Elsevier Science Ltd.
- Davidson Institute of Science Education, Weizmann Institute of Science, Rehovot, Israel.  
<http://www.weizmann.ac.il/pages/davidson-institute-science-education>
- Euler, M. (2003). Quality development: Challenges to physics education. Second International Girep Seminar, Udine, Italy.  
Online <http://www.fisica.uniud.it/~cird/girepseminar2003/abstracts/pdf/gt0.pdf>
- Goldberg, F. M., & McDermott, L. C. (1986). Student difficulties in understanding image formation by a plane mirror. *The Physics Teacher*, 24, 472-480.
- Langley, D., & Arieli, R. (2008). Fostering a view of electro-optical systems as products of design-based problem solving. Poster presented at the *GIREP-MPTL Conference*, Nicosia, Cyprus, August, 18-22, 2008
- Langley, D., Arieli, R., & Eylon, B. (2006). Mini-projects: Bridging the gap between school knowledge and model design. Poster presented at the *AAPT Summer Conference*, Syracuse, US, July 22-26, 2006.
- Langley, D., & Arieli, R. (2010). Digital photography for scaffolding project-based-learning. In D. Raine, C. Hurkett, & L. Rogers (eds.) *Proceedings of the GIREP-EPEC & PHEC 2009 International Conference "Physics Community and Cooperation"* (pp. 308-323). Leicester, England: The Centre for Interdisciplinary Science.
- Markowitz, D. G. (2004). Evaluation of the long-term impact of a university high school summer science program on students' interest and perceived abilities in science. *Journal of Science Education and Technology*, 13(3), 395-407.
- Milgram, R. M., & Hong, E. (1999). Creative out-of-school activities in intellectually gifted adolescents as predictors of their life accomplishment in young adults: A longitudinal study. *Creativity Research Journal*, 12(2), 77 – 87.

Mioduser, D., & Betzer, N. (2006). The contribution of project-based-learning to high-achievers' acquisition of technological knowledge and skills. *International Journal of Technology and Design Education*,  
Online: <http://springerlink.metapress.com/content/0313110168m166w2/fulltext.pdf>

## Energy for Everyone

Joel Rosenberg

Lawrence Hall of Science, U.C. Berkeley, California, USA  
jrosenberg@berkeley.edu

There seems to be no consensus in the physics education community about how to teach energy [1]. As Robin Millar writes about the U.K., "It is not an overstatement to say that the teaching of energy is in a mess" [2]. Yet given the urgency to revamp our energy system due to the combined threats of climate change, fossil fuel depletion, and increasing global energy use, everyone needs a basic understanding of energy use in their lives and society. We are refining what we call the "Energy for Everyone" (e4e) model, and we are including it as the foundation of an after-school curriculum.

This energy model is synthesized primarily from three existing curricula: the *Karlsruhe Physics Course (KPC)* from Germany [3], *Energy and Change* from the U.K. [4], and *CASTLE* from the U.S. [5]. We aim to help learners develop semi-quantitative "runnable, imagistic simulations" [6] of important physical systems drawn from their real-world lives, including home heating, transportation (heat engines), and electrical appliances (including power plants). The goal is for learners to visualize their personal energy use as part of local and global systems, and to see how they can help shape the future of those systems.

The model is based on the idea that intensive differences drive extensive flows. The model stays at a macroscopic level, an approach more common in engineering education than in science education. Given the difficulty learners have with learning energy in science, we believe a more intuitive, macroscopic understanding of how systems behave will help learners achieve "functional science literacy" [7]. The ideas we teach are based more on whether they are useful to learners than whether they match the contemporary science view.

Unlike most energy curricula, which attempt to combat the natural tendency for students to develop a fluid-like model for energy [2, 8], we embrace that model. One goal for the project is to help establish this approach as a viable *complementary* alternative model [9] - - perhaps even by calling it an engineering model -- that educators can feel confident teaching, and that is compatible with a more refined but complex microscopic view [10].

### **The e4e Model Used to Explain Home Heating**

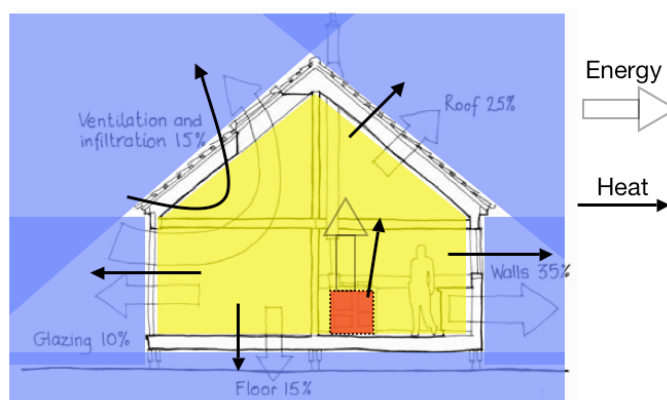
In our curriculum, we introduce the components of the e4e model during an introductory unit on home heating. We have learners build cardboard models of a single room house heated with a small incandescent night light bulb. As learners change the bulb brightness, add windows, doors, and insulation, and measure temperature changes, we teach the e4e model to help them make sense of their observations.

**1) Differences drive change, and differences tend to disappear.** This is a nice linguistic phrase from *Energy and Change* [11], and incorporates both a causal driving force and an endpoint at equilibrium. For thermal systems, a temperature difference is what drives change. In the case of the cardboard house, if the light bulb heater is turned off, the inside of the house will cool down as the temperature difference with the outside disappears.

To help students visualize the difference in temperature, we adopt the color-coding system from *CASTLE* [12]. The five colors are hierarchically arranged in the order of the rainbow. For thermal systems the colors represent temperature, where yellow "normal" represents room temperature:

RED . . . . .	HIGHEST above normal
ORANGE . . . .	Above normal
YELLOW . . . .	NORMAL
GREEN . . . . .	Below normal
BLUE . . . . .	LOWEST below normal

Students color multiple pictures of their house and its surroundings to show changes over time, as in a comic strip. The non-obvious causal mechanism of a temperature difference is made obvious by having students color the atmospheric temperature of the surroundings, which is often ignored [13]. See Figure 1 for an example.



**Figure 1:** Color coding makes the temperature difference more obvious. The heat and energy arrows represent two simultaneous flows driven by this difference, as explained below.

**2) It takes a difference to make a difference.** This is another nice phrase from *Energy and Change* [11]. It sets up the important idea that a driving force can be created, such as a temperature difference, but it requires some other driving force to do so. So after the light bulb is turned off and the house cools down, it's not going to warm up on its own -- it needs some hot object, like the glowing bulb, to re-create the temperature difference with the outside.

**3) Energy can be thought of as a fluid-like "stuff," even though it's not actually a fluid.** This model from *KPC* [14] helps students visualize energy as capable of being stored and transferred. For example, energy can be thought of as "stored in" fuels, and released by burning. The energy is more accurately thought of as stored in the fuel/oxygen system, but this simpler explanation is good enough for beginners. It makes sense to think of a wooden matchstick having less energy stored in it than a whole log of firewood, and gets at the extensive nature of energy.

*KPC* embraces a fluid-like (or "substance-like") model for energy. Warren [15] and Strnad [16] disapprove of this approach for being too unscientific, but Duit [8] concludes that for energy novices, "conceptualizations which suggest a quasi-material notion would appear almost unavoidable." Millar [2] agrees, noting that "this is a 'good enough' model to use when introducing the idea of energy to 11-14 year olds, which will not form a serious barrier to later learning." Renier et. al. [17] notes that "to completely ignore a student's existing materialistic conceptions and avoid materialistic language altogether may not be the most effective means of instruction."

In addition, by initially focusing on difference as the driver of change, *before* introducing energy as a quantity, we help students avoid the simple linear causal model where "energy makes things go." Ogborn [18] points out that "total energy is a *constraint*, not a generator of change."

**4) Heat can be thought of as another kind of fluid-like "stuff," different from energy (but still not actually a fluid).** This is another model from *KPC*, explained in more detail by Falk [19] and Herrmann [20]. The word "heat" is used to mean macroscopic entropy, a concept that doesn't really exist in physics. Temperature can be thought of as a function of the amount of heat (macroscopic entropy) in the system. When the light bulb glows, the house fills with heat and the temperature increases. The temperature difference created between the inside and outside of the house causes heat to flow out. A steady-state system exists when the heat flow into the house equals the heat flow out, maintaining a temperature difference.

This is an unorthodox approach to "heat." But there is already a "cloud of confusion" around the word "heat" since it is commonly used in physics to mean both *energy* (as a noun) and an *interaction* (as a verb) [21]. We use two extensive quantities for energy and "heat" (macroscopic entropy). For learners who continue in science, they can learn to differentiate between multiple meanings for the word "heat" when it appears in different contexts [22], including: 1) macroscopic entropy (as we use it); 2) a form of energy (noun); and 3) the "heating" process (verb), to be introduced with the "working" process [21].

**5) When differences drive change, energy flows with at least one other fluid-like quantity.** As the temperature difference drives a heat flow into the house, energy flows simultaneously with heat. In electricity education we expect students to differentiate between charge flow (current) and energy flow (power). A similar differentiation can be made in other branches, which sets up a nice analogy between them (as *KPC* demonstrates [23]). This is one important reason for introducing energy and "heat" as two separate flows.

The *KPC* model of "energy carriers" [24] replaces the traditional "energy forms" model. Each branch of physics has an intensive difference that drives an extensive quantity, and the extensive quantity can be imagined to "carry" the energy. Perhaps a better image is "energy partners," to emphasize their simultaneous rather than spatial pairing. Arrows in Figure 1 show the partners of energy and heat, and indicate approximate flow directions from higher to lower temperature.

**6) Heat can be produced but not destroyed** [19]. In the home heating example, we can say that the bulb produces heat, which fits with our everyday way of talking about heat. To cool the house down, we turn the bulb off and wait for the temperature difference to drive the heat out -- there is no "heat destroyer."

The idea that heat can be produced and not destroyed (i.e. it is half-conserved) makes it different from energy, which can be neither produced nor destroyed (i.e. fully conserved). This distinction provides a way of explaining "energy degradation" as heat production. Since energy always flows simultaneously with heat, once heat is produced, some energy will always be stuck with it! This is another important reason for using two separate flows when introducing energy and heat.

## **Outline of Curriculum**

Here is a list of mini units that build on the e4e model to explain other life-world systems.



**1) *How home heating works:*** As described above.

**2) *How heat engines work:*** Using a tin can to make a model of a turbine [25], learners explore how steam can turn a temperature difference into a pressure difference. They should see that heat is produced by burning fuel, energy is transferred from the fuel to the turbine as the steam (and heat) pass by, and heat and some of the energy end up in the surroundings. It is this last step -- the fact that the engine needs to cool -- that prevents a heat engine from ever using anywhere close to 100% of the energy from the fuel. An analogy with a waterfall is introduced, in the spirit of Carnot [26].

**3) *How power plants work:*** Power plants are basically heat engines connected to generators. Using a hand-cranked generator and small motor, learners see that a generator is just a motor run in reverse, and they can picture the generator connected to the turbine from the previous activity. Other power sources and loads are introduced using the Snap Circuits Green [27] electronics kit.

As a model for basic electricity, a hula-hoop is used to represent charge, as suggested by Härtel [28] and introduced as an initial model in *CASTLE* [12]. The stiff ring is held by the teacher (who represents the generator), and a learner (who represents the motor). When the teacher (generator) causes the ring to move (charge flow), the learner (motor) raises one hand to represent the motor turning. This model is "good enough" for explaining how energy is transferred by charge from a power plant generator to a home appliance. After a while the teacher would get tired, analogous to the plant running low on fuel. The teacher pushes/pulls on the ring to represent the "electric potential difference" or "voltage."

At this point students should realize that a temperature difference from the fuel creates a pressure difference in the steam, and the steam turns the generator to create an electric potential difference in the circuit. Energy flows from the fuel to the steam to the turbine to the generator to the motor. (We do not introduce the mechanics of a velocity difference driving a momentum flow from the turbine to the generator [29].)

**4) *The role of energy storage in a renewable systems:*** The sun doesn't shine all the time, and the wind doesn't blow all the time, so the more renewable energy sources we use, the more storage we need. Learners explore multiple energy storage approaches, including pumped water storage using a low-voltage water pump [30], lemon juice batteries [31], and water electrolyzed to produce hydrogen for a fuel cell [32].

**5) *The relationship between energy and climate change:*** Burning fossil fuels releases energy and produces heat, but also produces carbon dioxide. A physical model of a leaking bottle [33] is introduced as the "bathtub model" of our atmosphere, and is used to explain that "as long as we pour CO<sub>2</sub> into the atmosphere faster than nature drains it out, the planet warms" [34].

**6) *The scale of alternative energy sources:*** Griffith [35] has created numerous charts and illustrations of the Earth's energy budget, the pros and cons of alternative energy sources for the U.S., and the time scales required to bring these alternatives online. MacKay [36] has done similar work for the U.K. We adapt their analyses to give a sense of scale to the problem of revamping our energy system. The goal is to help learners understand the efficiency options on the demand side, and renewable options on the supply side. Sankey diagrams showing energy flows through the U.S. system are included to provide further perspective [37].

**7) Effective actions for reducing energy use:** Learners consider a list of effective actions individuals can take to reduce energy demand [38], and generate ideas for disseminating these ideas to their community. Learners are also introduced to "green jobs" career paths of energy technicians (home weatherization, solar panel installation) and researchers (energy efficiency, renewable energy).

## **Conclusion**

Overall, this curriculum project aims to make the energy system much more concrete and comprehensible to all learners. By the end, learners should be able to see their individual use in the context of their community, region, state, country, and globe. Since there are many decisions to be made at the individual level and higher, our goal is for learners to more clearly consider the consequences of those decisions.

## **References**

- [1] Heron, P., Michelini, M., Eylon, B.-S., and Stefanel, A. (2010). "Teaching about energy: Which concepts should be taught at which educational level?" GIREP 2010, Reims.
- [2] Millar, Robin (2005). "Teaching about energy." Department of Educational Studies Research Paper 2005/11, University of York.  
<http://www.york.ac.uk/depts/educ/research/ResearchPaperSeries/Paper11Teachingaboutenergy.pdf>
- [3] Herrmann, F. (2000). "The Karlsruhe Physics Course." *European Journal of Physics*, 21, 49-58.  
<http://www.ingentaconnect.com/content/iop/ejp/2000/00000021/00000001/art00308>
- [4] Boohan, R., and Ogborn, J. (1996). "Differences, energy and change: a simple approach through pictures". *School Science Review*, 77, 283, 13-19. <http://www.richard-boohan.org/publications/SSR96b.doc>
- [5] Steinberg, M. & Wainwright, C. (1993). "Using Models to Teach Electricity — The CASTLE Project." *The Physics Teacher*, 31, 353-357. <http://dx.doi.org/10.1119/1.2343798>
- [6] Clement, J., & Steinberg, M. (2002). "Step-Wise Evolution of Mental Models of Electric Circuits: A 'Learning-Along' Case Study." *The Journal of the Learning Sciences*, 11, 389-452.  
<http://www.jstor.org/stable/1466745>
- [7] Ryder, J. (2001). "Identifying Science Understanding for Functional Scientific Literacy." *Studies in Science Education*, 36, 1-44. <http://www.informaworld.com/smpp/content~content=a791786624&db=all>
- [8] Duit, R. (1987). "Should energy be illustrated as something quasi-material?" *International Journal of Science Education*, 1987, 9(2), 139-145. <http://www.informaworld.com/smpp/content~content=a757673162&db=all>
- [9] Linn, M., diSessa, A., Pea, R., & Songer, N. (1994). "Can Research on Science Learning and Instruction Inform Standards for Science Education?" *Journal of Science Education and Technology*, 3, 7-15.  
<http://www.springerlink.com/index/M0V714W721T5VW0K.pdf>
- [10] Doménech, J.-L., Gil-Pérez, D., Gras-Martí, A., Guisasola, J., Martínez-Torregrosa, J., Salinas, J., Trumper, R., Valdés, P., and Vilches, A. "Teaching of Energy Issues: A Debate Proposal for a Global Reorientation." *Science & Education*, 16, 43-64. <http://www.springerlink.com/content/81682422881262r3/>
- [11] Boohan, R., & Ogborn, J. (1996). *Energy and Change*. Hatsfield: Association for Science Education.
- [12] CASTLE curriculum Guide (2009). Distributed by PASCO.  
[http://www.pasco.com/file\\_downloads/zip\\_files/CASTLE\\_Student\\_Version.zip](http://www.pasco.com/file_downloads/zip_files/CASTLE_Student_Version.zip)
- [13] Grotzer, T. & Bell, B. (1999). "Negotiating the funnel: Guiding students toward understanding elusive generative concepts." In L. Hetland & S. Veenema (Eds.), *The Project Zero Classroom: Views on Understanding*. Cambridge, MA: Project Zero, Harvard Graduate School of Education.  
<http://www.pz.harvard.edu/ucp/overview/papers/negfun.pdf>
- [14] Herrmann, F., and Job, G (2006). *The Karlsruhe Physics Course: Volume 1, 2, 3, and The Teacher's Manual*. [http://www.physikdidaktik.uni-karlsruhe.de/publication/pub\\_fremdsprachen/englisch.html](http://www.physikdidaktik.uni-karlsruhe.de/publication/pub_fremdsprachen/englisch.html)
- [15] Warren J.W. (1983). "Energy and its carriers: a critical analysis." *Physics Education*, 18, 1983, 209-212.  
<http://dx.doi.org/10.1088/0031-9120/18/5/306>
- [16] Strnad, J. (2000). "On the Karlsruhe physics course." *European Journal of Physics*, 21, L33-L36.  
<http://dx.doi.org/10.1088/0143-0807/21/4/106>
- [17] Reiner, M., Slotta, J., Chi, M., & Resnick, L. (2000). "Naive Physics Reasoning: A Commitment to Substance-Based Conceptions." *Cognition and Instruction*, 18, 1-34. <http://www.jstor.org/pss/3233798>
- [18] Ogborn, J. (1990). "Energy, change, difference and danger." *School Science Review*, 72, 81-85.

- [19] Falk, G. (1985). "Entropy, a resurrection of caloric--a look at the history of thermodynamics." *European Journal of Physics*, 6, 108-115. <http://www.iop.org/EJ/abstract/0143-0807/6/2/009>
- [20] Herrman, F. (2004). "Entropy from the Beginning." *GIREP Conference 2004 Proceedings*, Ostrava. [http://www.girep.org/proceedings/conference2004/Friedrich\\_Herrmann\\_-\\_Entropy\\_from\\_the\\_Beginning.pdf](http://www.girep.org/proceedings/conference2004/Friedrich_Herrmann_-_Entropy_from_the_Beginning.pdf)
- [21] Shaw, R. (1974). "How do you teach heat in schools?" *Physics Education*, 9, 73-74. <http://dx.doi.org/10.1088/0031-9120/9/2/001>
- [22] Jeppson, F., Haglund, J., and Strömdahl, H. "Exploiting language in teaching of entropy." GIREP 2010, Reims.
- [23] Herrmann F., Wu, Guobin, Polig, M., Fuchs, H., D'Anna, M., and Rosenberg, J (2010). "Analogies: a key to understanding physics." GIREP 2010, Reims.
- [24] Schmid, G.B. (1982). "Energy and its carriers." *Physics Education*, 17, 212-218. <http://www.iop.org/EJ/abstract/0031-9120/17/5/002>
- [25] Benrey, R., and Schultz, R. "Experiment 7: A Model Geothermal Steam Engine." *Alternative Energy Sources: Experiments You Can Do...from Edison*, pages 26-28. <http://www.charlesedisonfund.org/experiments/HTMLexperiments/Chapter2/2-Expt7/p2.html>
- [26] Fuchs, H. (1987). "Entropy in the teaching of introductory thermodynamics." *American Journal of Physics*, 55, 215-219. <http://dx.doi.org/10.1119/1.15216>
- [27] Elenco Electronics (2009). "Snap Circuits Green Manual." <http://manuals.elenco.com/manuals/scg125.pdf>
- [28] Haertel, H. "How to teach about transition processes in so-called simple electric circuits." GIREP 2010, Reims.
- [29] Herrmann, F., and Schmid, G.B. (1985). "Analogy between mechanics and electricity." *Eur. J. Phys.* 6, 16-21. [http://www.physikdidaktik.uni-karlsruhe.de/publication/ejp/Analogy\\_mechanics\\_electricity.pdf](http://www.physikdidaktik.uni-karlsruhe.de/publication/ejp/Analogy_mechanics_electricity.pdf)
- [30] kidwind.org. Water Pump. <http://www.kidwind.org/xcart/product.php?productid=24&cat=79&page=1>
- [31] Muske, K., Nigh, C., and Weinstein, D. (2007). "A Lemon Cell Battery for High-Power Applications." *Journal of Chemical Education*, 84, 635-638. <http://pubs.acs.org/doi/abs/10.1021/ed084p635>
- [32] Thames and Kosmos. "Fuel Cell Quick Start." [http://thamesandkosmos.com/support/fuelcell\\_quickstart\\_v3.1.pdf](http://thamesandkosmos.com/support/fuelcell_quickstart_v3.1.pdf)
- [33] Science Enhancement Programme. "Modeling Climate Change." [http://www.mutr.co.uk/index.php?cPath=18\\_617](http://www.mutr.co.uk/index.php?cPath=18_617)
- [34] National Geographic (2009). "The Carbon Bathub." <http://ngm.nationalgeographic.com/big-idea/05/carbon-bath>
- [35] Griffith, S. (2008). *The Game Plan: A solution framework for the climate challenge*. [http://www.wattzon.com/pdfs/GamePlan\\_v1.0.pdf](http://www.wattzon.com/pdfs/GamePlan_v1.0.pdf)
- [36] MacKay, D. (2009). *Sustainable Energy - without the hot air*. UIT Cambridge. <http://www.withouthotair.com>
- [37] Lawrence Livermore National Laboratory. "Energy Flow Charts." <https://publicaffairs.llnl.gov/news/energy/energy.html>
- [38] Gardner, G., & Stern, P. (2008, September/October). "The Short List: The Most Effective Actions U.S. Households Can Take to Curb Climate Change." *Environment*. [http://www.environmentmagazine.org/Archives/Back\\_Issues/September-October\\_2008/gardner-stern-full.html](http://www.environmentmagazine.org/Archives/Back_Issues/September-October_2008/gardner-stern-full.html)

**Fun and Joy with Researching and Ruminating –  
The Erlangen Student Research Centre  
(‘Erlanger Schülerforschungszentrum ESFZ’) for Bavaria**

Jürgen Durst<sup>1\*</sup>, Angela Fösel<sup>2</sup>, Gisela Anton<sup>1</sup>

<sup>1</sup> Erlangen Centre for Astroparticle Physics (ECAP), Friedrich-Alexander-Universität Erlangen-Nürnberg, Erwin-Rommel-Str. 1, 91058 Erlangen, Germany

<sup>2</sup> Didaktik der Physik, Friedrich-Alexander-Universität Erlangen-Nürnberg, Staudtstr. 7, 91058 Erlangen, Germany

\* corresponding author, Email: [juergen.durst@physik.uni-erlangen.de](mailto:juergen.durst@physik.uni-erlangen.de)

## **Abstract**

'Fun and joy with researching and ruminating' is the motto for the Erlangen Student Research Centre ('Erlanger Schülerforschungszentrum' **ESFZ**) for Bavaria which was founded in spring 2009. The ESFZ (→ [www.esfz.physik.uni-erlangen.de](http://www.esfz.physik.uni-erlangen.de)) offers special support for students who are interested in science and technology. Unlike many other advancement initiatives, the ESFZ fully concentrates on the initiative and creativity of its participants: The students attend a oneweek science camp in Erlangen; during this week they carry out projects they have thought up themselves. Erlangen University provides the premises and the equipment for this 'project work experience', which is a form of practical training for university students of physics that is unique in Germany, for the ESFZ. On top of the excellent facilities regarding appliances and methods, former university students of the project work experience act as tutors, motivating the activities of the students and supporting them competently. Furthermore, where this is requested by the students, professors and scientists of the university provide subject-specific support. The ideas for research come from the students. While some of them arrive at the science camp with their project ideas already prepared in their minds, others use the opportunity of joining up with fellow students at the science camp and start discussing there and then what subject they would like to delve into. There are 'lone wolves', as well as groups of up to four students working together. Some of the projects are completed within the week, but many others take longer and are continued at home, or the students may indeed decide to come back to the next science camp or in between camps. Many students intend taking part in competitions like 'Jugend forscht' with their work. In the lecture, the objectives and contents of the ESFZ are introduced in detail; the run of events during the first one and a half years of the Erlangen Student Research Centre is chronicled.

## **1. Introduction**

At ordinary school physics labs, both in grammar schools and at university level, experiments are carried out with pre-assembled equipment, moreover, in most cases the experiments are run using pre-assembled instructions. These activities are definitely valuable and justified. However, students who are genuinely interested in science and technology should also have the opportunity to carry out projects they have thought up themselves. The Erlangen Student Research Centre ('Erlanger Schülerforschungszentrum' **ESFZ**) offers special support for realising those projects. Besides, the students – who all of them are at least 16 years old – are encouraged to take part in competitions like 'Jugend forscht' with their work.

In the following text we will go into what might be considered the special characteristics of our concept; in this way, *special aspects* as well as *special risks* will be presented.

### 1.1 Special aspects of the concept

It is our main aim to *encourage students' interest in science and technology*. The ESFZ fully concentrates on the *creativity* and *initiative* of its participants. Besides, we want to support the *critical faculties*, i. e. the ability to offer and accept fair criticism. All of these particular objectives are essential for physics education as well as for education in general: Independently acquired contents can be profoundly processed and sustainably stored. Successful projects lead to a long-term motivation in science and technology. Creativity, initiative and critical faculties are fundamental for successful research (in a future career).

However, there are also risks inherent in this concept, owing to the idea of 'open researching and ruminating'.

### 1.2 Risks of the concept

There might be *frustration* if a project does not work out as expected, and also *disillusionment* when students come to the conclusion that researching is not always great fun. Finally, there might ensue *demotivation* if there is too much frustration.

Let us come back to these risks of the concept later and presently deal with the facilities within the Erlangen Student Research Centre.

## 2. Facilities within the Erlangen Student Research Centre

Since 1999, Erlangen University – unique in Germany - has been offering a special form of practical training for university students of physics in the third semester of bachelor studies as part and parcel of their education, the so called '*project work experience*' ('Projektpraktikum' **PP**): Six university students of physics together with a tutor make up a team. It is their assignment to put into practise four projects. What is important and new about this, in comparison with traditional practical trainings, is that the ideas for the research projects come from the university students, that the experimental tables are empty and that the cubicles of equipment are well-stocked.

The equipment for the project work experience consists of seven *rooms to carry out the experiments*, especially e.g. a dark room and a room with vibration-cushioned tables. In each of the rooms, students can avail of *computers* and the Computer Assisted Science System **CASSY**<sup>1</sup> for measured value acquisition. A seminar room with a *small research library* also exists. The *repository* is made up of well-stocked cubicles of physics equipment. A considerable machine shop is at the students' command, and it is also possible to use the *machine shop and the electronics repair shop of the Department of Physics*.

Erlangen University – unique in Germany - provides the premises and the equipment for this project work experience for the ESFZ. Within the ESFZ the students' research projects take place at what are known as science camps.

---

<sup>1</sup> CASSY: Computer Assisted Science System offered by the company LD Didactic GmbH, Hürth, Deutschland (→ <http://www.ld-didactic.de/index.php?id=27&L=0>, 10.10.2010)



### 3. Science Camps of the Erlangen Student Research Centre

The students attend a one-week science camp in Erlangen during their school holidays, and in this week carry out projects they have thought up themselves. As has been already mentioned, the ideas for research come from the students themselves. While some of them arrive at the science camp with their project ideas already prepared in their minds, others use the opportunity of joining up with fellow students at the science camp and start discussing there and then what subject they would like to delve into. There are 'lone wolves', as well as groups of up to four students working together. The research takes place in the rooms of the project work experience and usually lasts from 9 am to 7 pm every day. On top of the excellent facilities regarding appliances and methods, former university students of the project work experience act as tutors, motivating the activities of the students and supporting them competently. Furthermore, where this is requested by the students, professors and scientists of the university provide subject-specific support. The students stay at Erlangen Youth Hostel, have lunch together at the Student Cafeteria and eat out at Erlangen restaurants in the evening. ESFZ covers the costs for the complete science camp except for the journey. Some of the projects are completed within the week, but many others take longer and are continued at home, or the students may indeed decide to come back to the next science camp or in between camps.

The question remains, how do we recruit students and where do they come from? How is the schedule of a science camp to be visualized? What is a 'typical' project dealt with in the science camp?

#### 3.1 Recruiting students for the science camps

Abiding by the motto 'Fun and joy with researching and ruminating' we have been advertising for the Erlangen Student Research Centre and accordingly for the science camps prior to the first science camp in February 2009, and we continue to do so today. We contact schools for higher education in Bavaria, as well as former and current participants in competitions, with the main focus on science and technology. The figures (Fig. 1 and Fig. 2) below show the current version of the ESFZ-flyer.



Figure 1: Flyer for ESFZ and science camps, face.



Figure 2: Flyer for ESFZ and science camps, reverse side.

### 3.2. Dates of past science camps and hometowns of participants

Science camps that have been held to date:

- 23rd – 27th February 2009 (so called 'Faschingsferien', i.e. mid-winter break)
- 14th – 18th April 2009 (Easter holidays)
- 7th – 11th September 2009 (summer holidays)
- 2nd – 6th November 2009 (autumn half-term)
- 15th – 19th February 2010 (so called 'Faschingsferien', see above)
- 6th – 10th April 2010 (Easter holidays)
- 2th – 6th September 2010 (summer holidays)

Altogether, there have been approximately 150 participants coming from 70 grammar schools (and 1 business company). The applicants/participants came from all over Bavaria. We regularly had to choose between applicants because we cannot work adequately with more than 28 students at a time in the rooms of the project working experience. In April 2009, for example, we accepted 22 out of 26 applicants, in September 2010 it was 28 out of 41. The decision – based on an application in written form by the candidates (cf. section 3.4) – was made taking into account considerations like the following:

- Can we serve the suggested projects adequately?
- Will the candidates be a good match?
- Will there be – from April 2009 on – a sufficient number of experienced participants in a science camp to continue with the idea of the ESFZ?

Fig. 3 shows the hometowns of the participants. The number of individual participants for each town is indicated. The Figure distinguishes between participants of former science camps (red), students who took part in the camp in September 2010 and in former camps (green), and finally students who took part in the science camp in September 2010 for the first time ever (blue).

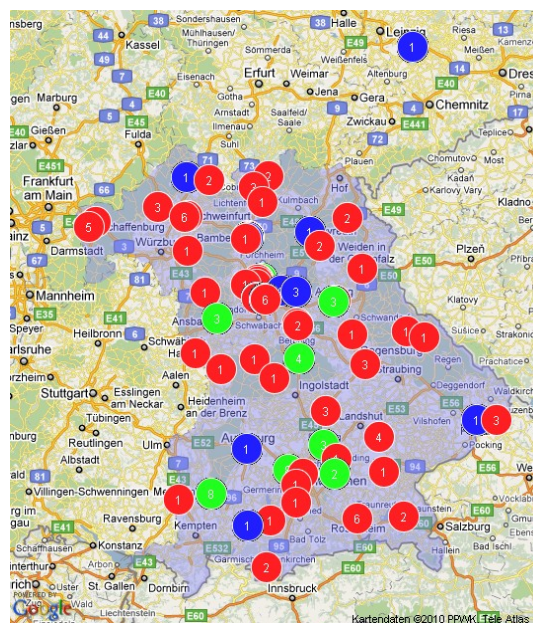


Figure 3: Hometowns of participants (description of the colors in the text).

### 3.3 Schedule of a science camp

As mentioned before, some of the students arrive at the science camp with their project ideas already prepared in their minds, with others using the opportunity of joining up with fellow students at the science camp and starting to discuss there and then what subject they would like to delve into. As an example for the former option, we have the growth from a rough idea to the project 'water jet meets watchglass' – hydromechanical investigations, as an example for the second option, there is e.g. the construction of a light bulb, which will be presented later on. (both cf. section 3.5)

In the course of the first day, students plan the sequence of work concerning their projects and first jobs are started. The tutors assist by 'calling into question'. Over the next few days, students work on their projects. On the last day of the science camp, each team presents its project (cf. Fig. 4), afterwards the students tidy up their rooms.



*Figure 4: Final presentation of the projects.*

A lot of the projects begun at a science camp do not come to an end during this camp. Obviously, students are invited to join the next camp or to make an extra/additional appointment in between camps.

### 3.4 Type of assistance given during a science camp

Missing physical equipment is – where possible – borrowed from other institutes. Mechanical and electronic constructions necessary for the projects are made in the machine shop and in the electronics repair shop, based on a good deal of thoughts by the students themselves. Tutors help discussing theoretical problems and they also encourage students to do literature research about the fundamentals of their projects. Additionally, they give hints on the appropriate experimental set-up, help students choose suitable devices for measurements of observables and help them get used to them, and furthermore assist the students in the analysis of their measurements. Sometimes tutors give tutorials, e.g. if students need more sophisticated maths for their project than that already taught at school. Where it is requested by the students, professors and scientists of the university provide subject-specific support. They also create ties between the students and the university as well as other institutions.



### 3.5 From creative idea to the project – two examples

Let us look at the two examples already mentioned - 'water jet meets watchglass' (hydromechanical investigations) and construction of a light bulb to show the development from a creative idea to a fascinating project.

#### 3.5.1 Hydromechanical investigations: Water jet meets watchglass

From Fig. 5 below, you will see a part of a candidate's registration form for one of our science camps: The student applied for the camp with a creative idea for research: He intended to investigate the geometrical shape that is created after a jet of water impinges on a spoon.

**Haben Sie schon Ideen für ein mögliches Projekt? In diesem Fall beschreiben Sie bitte kurz Ihre Idee:**  
In Rahmen meiner Facharbeit in LK Physik möchte ich das Phänomen untersuchen, das sich beobachten lässt, wenn man im Spülbecken einen Löffel unter das fließende Wasser hält: es wölbt sich eine paraboloidförmige Glocke aus einem dünnen Wasserfilm.  
Der Versuchsaufbau besteht aus einem erhöht angebrachten Uhrglas (kann mit größeren/kleineren Gläsern ausgetauscht werden), auf das senkrecht ein Wasserstrahl trifft. Der Schwerpunkt der Untersuchungen liegt darauf, Geschwindigkeit, Impuls und Zerlegung des Impulses beim Aufprall des Wasserstrahls zu bestimmen. Außerdem soll unter Anwendung der Gesetze des schrägen Wurfs in  $R^3$  die Glockenform in Abhängigkeit von Uhrglaswölbung und -größe und evtl. der Oberflächenspannung untersucht werden.  
Ferner möchte ich die Geometrie der Glocke mit den ermittelten Größen so exakt wie möglich in Gleichungen beschreiben.

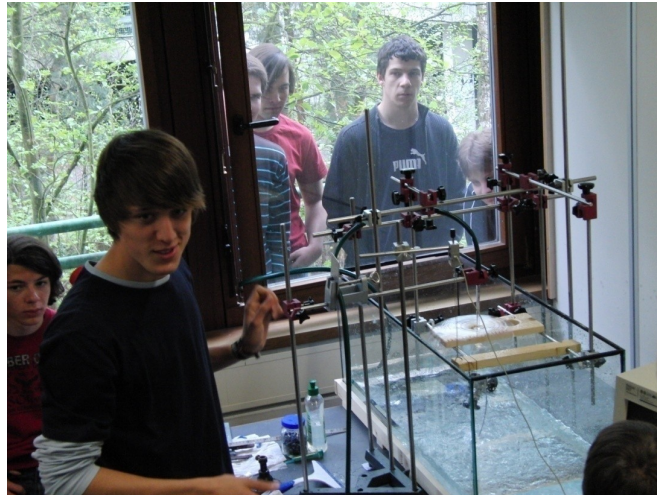
Figure 5: Extract from a filled-in registration form.

With a little bit of help from the tutors, the student developed the initial experimental set-up. (cf. Fig. 6):



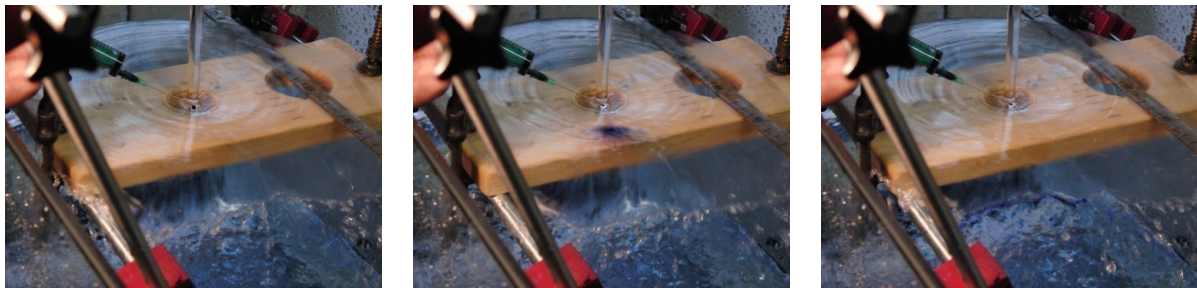
Figure 6: Water jet meets watchglass, initial experimental set-up.

Shortly after set-up, it became evident that one has to take a look from the side. Tutors encouraged the student to optimise the set-up to deal with this objective. – Learning to optimise an experiment is an essential part in researching. Following this insight, an improved set-up was assembled (cf. Fig. 7).

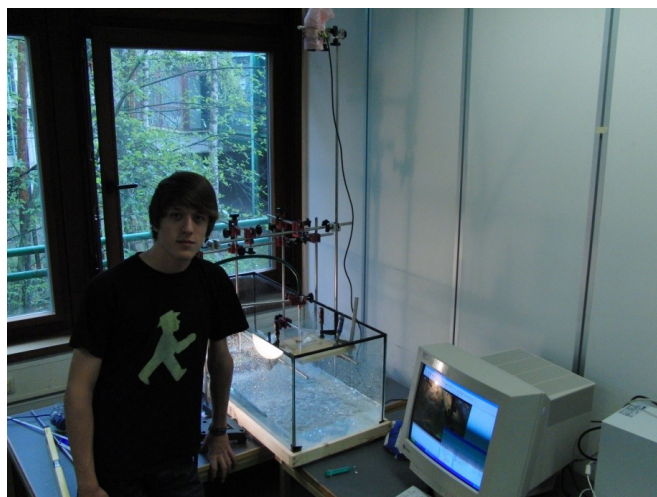


*Figure 7: Water jet meets watchglass. Optimised experimental setup.*

By and by the student, with the help of professors and scientists from Erlangen University, developed an experimental set-up using video analysis (cf. Fig. 8); and with the assistance of the tutors the software used for doing the video analysis quickly disclosed itself to the student. From this moment on, quantitative measurements were possible (Fig. 9).



*Figure 8: A setup for quantitative measurements is produced.*



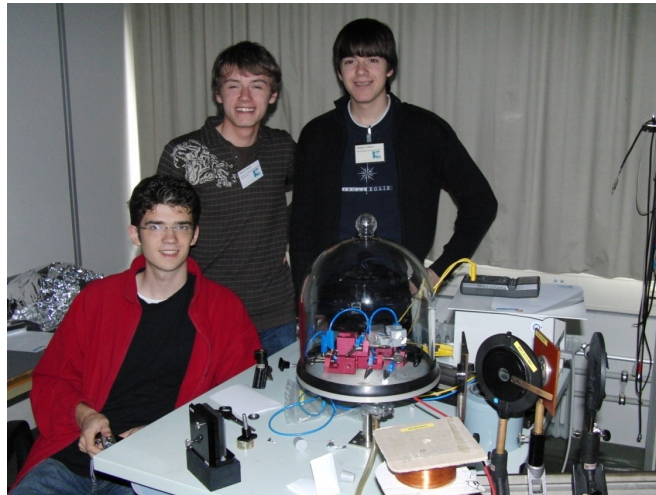
*Figure 9: With the aid of video analysis, quantitative measurements are possible: The track speed of the water after striking the watchglass can be determined.*



In the following experiments the student understood that an oval shaped initial cross section of the water jet changes during time caused by surface tension. The experiment was extended by research of this phenomenon. Further investigations within this really appealing project are imaginable in the near future, possibly culminating in the participation in competitions like 'Jugend forscht'.

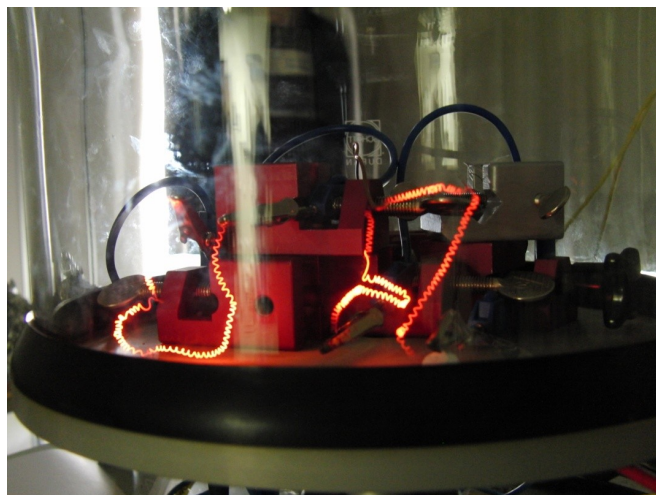
### 3.5.2. Construction of a light bulb

Three students, coming from different grammar schools, used the opportunity of joining up with each other at the science camp and started discussing on the spot what subject they would like to tackle. Finally, they decided to construct a light bulb.



*Figure 10: Self-made light bulb, team with experimental setup.*

The team intended to make a spectroscopy of the self-made bulb. The likewise self-made spectrometer was first used to investigate energy saving lamps and common light bulbs and was eventually made sense of. Initially, the students were frustrated because they did not manage to generate the current necessary to let the self-made bulb glow for a long period or with high intensity. Team work and the help of the tutors did however ensure that they found out the reasons why long duration and high intensity glowing might be difficult to achieve with their construction with hands-on materials. Finally, the team succeeded in constructing a bulb with the spiral wound to form the ESFZ-logo (cf. Fig. 10 and 11).



*Figure 11: Self-made light bulb, glowing.*

## 4. Summary and conclusions

In this lecture, contents and objectives of the ESFZ have been introduced in detail. The run of events during the first one and a half years of the ESFZ has been chronicled.

Individual experiences and anonymous questionnaires (feedback in parts, cf. Fig. 12) have shown that the ESFZ encourages students' interest in science and technology. The participants of the science camps all appreciate that the Erlangen Student Research Centre fully concentrates on the creativity and initiative of its participants - unlike many other advancement initiatives. That said, it has to be admitted that there are some other institutions which follow up similar contents and objectives like the ESFZ, for example the PhysikClub at Kassel (for their concept, cf. e.g. [1]) or the Schülerforschungszentrum Bad Saulgau (for their concept cf. e.g. [2]) or the Schülerforschungszentrum in Lörrach (cf. [3]). Of those institutions there are, however, only few and far between in Germany, and the ESFZ with its location at Erlangen University, combined with the possibilities associated to this fact – use of the machine shop and the electronics repair shop of the Department of Physics, subject-specific support by scientists, lease of equipment - is unique not only in Bavaria, but also in Germany.



Figure 12: Feedback from anonymous questionnaires.

The risks already mentioned in section 1.2 are not considered to be drawbacks in our concept: Dealing with frustration is simply something that has to be learned. Only those who can pull their project through can rise from it and positively feel their success. It makes absolute sense to discover that research, indeed like life itself, is not always fun, but performance. It is good to know that frustration here happens in a team which means a long-term negative effect is avoided. – The Erlangen Student Research Centre offers the opportunity for personal growth from all these experiences!

Not only from the feedback discussed above, it is apparent that the ESFZ is an ongoing inspiration even after the event, as lots of participants intend taking part in competitions like 'Jugend forscht' with their work and a fair few have already successfully done so. This trend will continue to be promoted.

## References

- [1] Haupt, Klaus-Peter. *Physik als Event: Der PhysikClub in Kassel*. Spektrum der Wissenschaft. Dezember 2005. p. 86-89.
- [2] Jorda, Stefan. *Forsche Schüler*. Physik Journal, Wiley Verlag. 3 (2004) Nr. 2. p. 10.
- [3] Keuntje, Maïke. *Wer sucht, erfindet!* Physik Journal, Wiley Verlag. 7 (2008) Nr. 5. p. 7-8.
- [4] Dvorak, Leos. *Labs outside labs: miniprojects at a spring camp for future physics teachers*. European Journal of Physics. 28 (2007). p. 95-104.

# The Perception of Physics in Secondary School Students near Milan. An analysis related to "Tracks", a Physics Show for Secondary School

Marina Carpineti<sup>1</sup>, Michela Cavinato<sup>1</sup>, Marco Giliberti<sup>1,2</sup>, Nicola Ludwig<sup>1</sup>,  
Laura Perini<sup>1,2</sup> and Elena Veronesi<sup>3</sup>

<sup>1</sup> Dipartimento di Fisica, Università degli Studi di Milano, via Celoria 16, 20133 Milan, Italy

<sup>2</sup> INFN-Sezione di Milano, via Celoria 16, 20133 Milan, Italy

<sup>3</sup> University Student in Mathematics

*e-mail: marco.giliberti@unimi.it*

## Abstract

The SAT (Science At Theatre) Laboratory of the Physics Department of the University of Milano has been researching for six years on the opportunities given by theatrical techniques to improve public perception of Physics. In these six years, four shows have been written and performed by the authors of this paper with the help of different theatre directors. The shows are addressed to students of different age so as to cover the whole age spectrum: from Primary School to University.

"Tracks", in particular, is addressed to the last years of Secondary Schools and University. The script deals with three physicists travelling to a Conference where they are going to present the results of their research. Each of them carries his baggage of experiments, books and personal experiences while the journey becomes a symbol of the research.

The aim of the show is to create fascination and increase the motivation for the study of Physics. The main guidelines in the construction of the show have been: 1) no popularization (i.e. so no simplified explanations) and 2) large use of emotions in making the story, in order to transmit a strong imaginary reference for Physics. One of the most striking features of this show (as well as of all the others) is the realization of real physics experiments on stage.

In this paper we will report on the results of an analysis on the perception of Physics in Secondary School Students before and after the vision of the show "Tracks". It is based on the answers to an anonymous questionnaire given to nearly thousand students before and after the vision of the show and to another one distributed to their teachers.

## 1. Introduction

The OECD Program for International Student Assessment – PISA (2003-2006) [1] has put in evidence the deep lack of basic scientific and mathematical competencies of Italian students.

Italy, among 57 participating countries, turned out to be in the 33<sup>rd</sup> place for reading competences, in the 36<sup>th</sup> for scientific culture and in 38<sup>th</sup> for mathematics one. Furthermore, as many as 25.3% of Italian students result below the baseline of sufficient level, while less than 5% of them reach the two higher levels for science competences (against an average, across OECD countries, of 8.8%).

Unfortunately the OECD-PISA research does not reveal anything about the image that students have of science and of scientists. A survey made by Eurobarometer (European Commission 2001) [2] has linked the lack of attraction of science for young people mainly to the perceived difficulties of science lessons and to the too low profits earned by researchers. Nevertheless a survey, carried out by IRPPS-CNR [3] on 800 Italian students, puts the profession of scientist in the second place (27%) in the scale of social importance, immediately after the profession of entrepreneur (28%).

In 2004 the Physics Department of the University of Milano gave birth to the SAT (Science At Theatre) laboratory [4-6]. The idea to promote Science, and more properly Physics with theatre stemmed from both previous data and the observation that most adults perceive it as a difficult and alien subject, studied by strange people.

From here the desire to promote physics and its wonders, starting from a certainty: physics is fascinating and surprising.

The main intentions of SAT are:

- to promote actions for exploring new ways of Physics communication (mainly through Theatre) which are propaedeutic to Physics Education and effective in both increasing students' motivation, intended as a personal attitude that supports "virtuous" behavior, and encouraging the study of Physics;
- to study a possible synergy between formal and informal activities which can facilitate the learning of disciplinary skills in students;
- to search for pre-service and in-service teachers training materials devoted to link formal and informal education in order to promote curricular development of physics themes presented in informal activities.

The main guidelines followed by SAT in the construction of shows can be easily summarized in the following statements:

- 1) performances must not be lessons: they should communicate charm, not explanations;
- 2) performances must not concern biographies of scientists: the leading character of the shows must be Physics;
- 3) performances must avoid popularization: physics is complicated, but precisely in its complexity there is richness and fecundity. Simplified concepts do not reach the heart as the strength of the ideas.

Up to now SAT has realized four Theatre Shows and a Show-Lecture about Physics addressed to nearly the whole spectrum of students' ages (8-19).

A description of the performances, which have involved (from Primary School to University students and to a generic public) an audience of about 80.000 people among which about 6.000 teachers, can be found in [4].

## 2. Research, instruments and methods

In order to better understand the public we were addressing the shows, we planned a research with about 1000 Secondary School Students in occasion of the vision of the show "Tracks" that was especially performed for schools by three of the authors (Carpineti, Giliberti, Ludwig) in a theatre in the neighborhood of Milano.

The research questions were the following: what is the image of science in Milan high-school students? Does it change with age? What is, in student's mind, the connection between physics and culture, physics and theatre and physics and society? What do students think that to be a physicist consists of?

Two months before the cycle of performances of the show, an anonymous questionnaire, called "IS" (Image of Science) questionnaire, has been given to about 1000 students. The same questions, mixed with the ones of a new "SM" (Students Motivation) questionnaire, has been given again to the students after the vision of the show [7].

The proposed IS questionnaire is the following:

- Question 1)  
Underline among the listed disciplines those that in your opinion are experimental sciences: Biology, Mathematics, Astrology, Psychology, Paintings, Chemistry, Astronomy, History, Gastronomy, Medicine, Physics, Informatics, Architecture, Philosophy, Philology. (*This order of the disciplines has been drawn by lot*).
- Question 2)  
Describe in 3 lines the way you imagine the work done by a physicist.
- Question 3)

Physics is (choose and underline three of the following attributes): Exact, Poetic, Creative, Concrete, Rigorous, Fascinating, Tedious, Useless, Verifiable, Abstract, Difficult.

- Question 4)

Express, giving a mark from 1 to 10, your agreement or disagreement about these statements (1=complete disagreement and 10=complete agreement)

Physics gives an important contribution to society

Physics gives an important contribution to the way of thinking in general

Physics is too specialist in order to be understood by most of people

I'm not interested in Physics and I do not see why I should be

It is important that young people have basic notions of Physics

- Question 5)

Which relationship do you think there is, or there might be, between Physics and Theatre? (Underline your answer/answers)

No relationship

Both give a representation of the world

By theatre, lives of famous scientists can be represented

Both deal with topics that generate passion

A theatre show can represent physics experiments and the job of a physicist

Sometimes science is spectacular

### 3. Data Analysis

The students involved were not selected in any particular way (they were just those coming to see "Tracks") so they were not a representative sample of Lombard students population. Nonetheless, as they were more than 1000 students, coming from six different kinds of school (from technical art school to classic or scientific high school) and with age range of five years, it was well worth trying the study.

The analysis we briefly report on regards the answers given to the IS questionnaire before and after the vision of "Tracks".

The first interesting feature is that the answers given by students in the pre-show questionnaire are on average the same in quality and quantity as those given more than two months later, after the vision of the show. So the answers seem to be nearly "stable" in time (for instance, they could have changed after the study of some new topics, or the vision of some TV programs, or even of our shows...) and therefore we believe they are meaningful. This means that we believe that the emerging image of Physics is almost reliable. The data we are going to report in the following refer to the pre-show IS questionnaire.

We pinpoint that we will not report here, instead, on the effectiveness of the show "Tracks" in modifying students' motivations towards Physics, as it is documented by the answers given to the SM questionnaire after the vision of the show.

#### 3.1 Analysis of the answers to question 1

The percentage of underlined disciplines permits to put them in the following order: History 3%, Philosophy 6%, Philology 7%, Paintings 9%, Architecture 9%, Psychology 13%, Informatics 21%, Astrology 22%, Gastronomy 23%, Mathematics 32%, Astronomy 45%, Medicine 72%, Biology 78%, Chemistry 89%, Physics 91%.

It is interesting to stress the ranking of Astrology and Gastronomy which are considered experimental sciences by more than 20% of the students. On the contrary it is well clear that Medicine, Biology (more than 70%), Chemistry and Physics (about 90%) belong to experimental sciences.

To better understand how many students could really distinguish between experimental sciences and other disciplines, we divided the students into "Charmed" and "Uncharmed"; Charmed students were those who underlined Physics and Chemistry and at least one between Biology and Astronomy and who underlined neither Astrology nor Painting.

We could see that the percentage of Charmed students grows with the class attended (from 44% in the first two classes to 63% in the fifth class) and changes with the type of School (from 40% in Art Institutes to 58% in Scientific High School and 59% in Classic High School).

### ***3.2 Analysis of the answers to question 2***

The "free" answers given by students have been divided into the following categories: a physicist

- "makes experiments in the lab" (ex. " I believe that he mainly works in the lab, as his work constantly needs hypothesis and experiments")
- "makes observations on reality" (ex. " He is able to observe with concrete realism the world around")
- "does a theoretical study" (ex. "I think that a theory is developed and studied").
- "demonstrates and verifies physical laws" (ex. " With the help of physical laws he/she discovers other important laws")
- "teaches" (ex. "... if he is not lucky he teaches at school")
- "makes a beautiful but difficult job" (ex. " It's a very fascinating work to try to understand nature. It 's difficult but beautiful")
- I do not know
- other
- no answer

The result of the previous categorization is that the work done by a physicist is seen mostly as an experimental activity, since more than 50% of answers must be included in the category "makes experiments in the lab" and 45% of them in the category "makes observation on reality". On the contrary, less than 25% of students thinks that the job done by a physics is a theoretical study and less than 3% thinks that a physicist makes a beautiful but difficult job. Obviously the sum of the percentages exceeds 100% as each answer can belong to more than one of the listed categories.

### ***3.3 Analysis of the answers to question 3***

The attributes of Physics can be listed in the following way: Poetic 3%, Useless 4%, Abstract 8%, Creative 11%, Tedious 13%, Exact 27%, Fascinating 31%, Difficult 43%, Rigorous 43%, Concrete 59%, Verifiable 78%.

In the answer "Difficult" we can see the only meaningful difference between male and female. Physics is difficult for 32% of males and for 54% of females.

### ***3.4 Analysis of the answers to question 4***

- Physics gives an important contribution to society: the average mark is 7.4/10.
- Physics gives an important contribution to the way of thinking in general: the average mark is 5.8/10.
- Physics is too specialist in order to be understood by most of the people: the answer is "Yes" for 64% of females and 54.4% of males.
- I'm not interested in Physics and I do not see why I should be: the answer is "No" with a percentage of 78%.
- It is important that young people have basic notions of Physics: the answer is "Yes" for 87% of students.



### **3.5 Analysis of the answers to question 5**

On the average, two answers have been underlined. More than 50% of students think that both Physics and Theatre give a representation of the world and more than 40% underline that a theatre show can represent physics experiments and the job of a physicist.

Even if it could be an obvious answer especially for who has never seen a representation similar to "Tracks", only 20% of respondents think that by theatre, lives of famous scientists can be represented. The fact that both Physics and Theatre deal with topics that generate passion is thought by 10% of students and the answer regarding the spectacularity of science reaches a percentage of about 35%.

### **Conclusions**

In this paper we have analyzed only the answers to the pre-show questionnaire. Since the results referring to the same questions of the post-show questionnaire seem to be nearly the same as those of the pre-show questionnaire, we are confident that they can be a reliable snapshot of the inquired situation.

We can thus conclude that nearly half of our students is unable to distinguish between experimental sciences and other disciplines.

Physics is considered an experimental science (91%).

Physics is difficult for 32% of males and for 54% of females, it is a concrete discipline (60-65%), it is very important for society (82%) and very linked to reality.

The cultural aspects of Physics do not reach a sufficient mark (5.8/10) and the abstract and theoretical aspects are even less put in evidence (<25%) as well as the creative ones (15%).

On the other hand, few students think physics is tedious (10%) or useless, and 87% of students believe that it is important that young people have basic notions of Physics.

Moreover, for more than 30% of the students Physics is even fascinating.

### **References**

- 1) [http://www.invalsi.it/download/pdf/pisa06\\_Primirisultati\\_PISA2006.pdf](http://www.invalsi.it/download/pdf/pisa06_Primirisultati_PISA2006.pdf)
- 2) European Commission, Eurobarometer Unit, Europeans, Science and Technology, Eurobarometer, 55.2, 2001.
- 3) M. C. Brandi, L. Cerbara, M. Misiti, A. Valente, "Giovani e scienza in Italia tra attrazione e distacco", JCOM 04(02)(2005)A01.
- 4) <http://spettacolo.fisica.unimi.it/>
- 5) M. Cavinato, M. Giliberti, "La Fisica in un Laboratorio, di Teatro", Scienzainrete, 16 aprile 2010, <http://www.scienzainrete.it/contenuto/articolo/La-fisica-un-laboratorio-di-teatro>
- 6) M. Carpineti, N. Ludwig, "Fisica e Teatro: una scommessa vinta dal laboratorio SAT", Scienzainrete, 26 aprile 2010, <http://www.scienzainrete.it/contenuto/articolo/Fisica-e-Teatro-una-scommessa-vinta-dal-Laboratorio-SAT>
- 7) E. Veronesi, "La percezione della fisica negli studenti di scuola superiore: indagine statistica collegata allo spettacolo teatrale Tracce", Relatore M. Giliberti, Correlatore M. Cavinato. Elaborato finale, laurea triennale in Matematica, Università degli Studi di Milano, 2009.

### 3.8 – Teacher education

---

# **An Inquiry-Based Approach to Physics Teacher Education: the Case of Sound Properties**

Claudio Fazio, Giovanni Tarantino & Rosa Maria Sperandeo-Mineo

*UoP\_PERG (University of Palermo Physics Education Research Group)*

*Dipartimento di Fisica, Università di Palermo, Italia*

Email: claudio.fazio@unipa.it

## **Abstract**

In this paper we describe some results of an experimentation on Pre-Service Physics Teacher Education performed with a group of non-Italian Trainee Teachers engaged in one-month mobility activities at University of Palermo, in the framework of the EU Project “Move’in Science”. Some preliminary results of the experimentation of a Teaching/Learning Unit about Mechanical Wave propagation are presented, with particular reference to mental models about wave propagation evidenced by Trainee Teachers. Their understanding of the relevance of pupils’ mental model knowledge, in the framework of what a teacher should do to be an “effective” teacher, is also discussed.

## **1. Introduction**

The design and validation of new models for pre-service and in-service science teacher education is a key subject in today’s Science Education Research. Many literature results show the pedagogical efficacy of educational approaches where teachers work in special-designed teaching/learning environments, concentrating on inquiry-based laboratory and modelling activities [1, 2].

The growing awareness of the centrality of teachers in all learning processes [3, 4], has pushed the research community to focus on teachers’ knowledge and how it can be directed towards an appropriate form for teaching [3, 5] by integrating subject matter knowledge and pedagogical knowledge into a form of knowledge appropriate for teaching, the Pedagogical Content Knowledge (PCK) [6, 7].

Research has built on educational models scaffolding the development of PCK in in-service and pre-service teachers, by analyzing its construct in experienced school teachers [8], or designing and experimenting learning environments based on the Educational Reconstruction model [2, 9, 10]. Different PCK features have been found that can help the researcher to define and shape PCK building in teachers [11]. Particularly, Park & Oliver [8] have found that teachers’ understanding of students’ misconceptions (or common sense mental models, see [12]) is a salient factor that can shape PCK in planning and conducting instruction and assessment, and is, so, important to develop.

In this paper we describe some phases of an approach to Pre-Service Physics Teacher Education developed at University of Palermo and implemented in different contexts [2, 13, 14]. In particular, we here refer to the implementation of this approach in the framework of the EU Project “Move’in Science” [15]. The Project, dealing with Physics and/or Mathematics Pre-Service Teacher Education, involved seven Institutions from six different European Countries: Belgium, Germany, Lithuania, Italy, Romania, and Slovak Republic. It was aimed at proposing transformation of the teacher education approach to get to new models of PCK building in Trainee Teachers (TTs). The Project general approach was to stimulate an inquiry-based set up in teacher education, where TTs start from problematic situations commonly found in real life and are guided to test on their own understanding the same teaching/learning tools they are supposed to use with their future pupils.

Here we discuss some phases of a Workshop (W) on Mechanical Wave propagation administered to a group of non-Italian TTs engaged in the one-month MiS mobility activities at University of Palermo.

## **2. The Workshop on Mechanical Wave propagation**

The W (30 hours) has been structured in different phases, which analysed the basic physics knowledge concerning mechanical wave propagation. In detail, the W focused on

1. the analysis of pupil mental models about wave propagation;
2. the study of real life situations concerning waves and sound;
3. the preparation of teaching/learning sequences to be experimented in Upper Secondary School classrooms.

The W development shared many characteristics with the Italian approach to Science Teacher Education, that can be defined as a “sequential” approach. This means that the acquisition of the disciplinary knowledge is intended as a pre-requisite to education for teaching. As a consequence, our hypothesis about PCK construction involved that TTs had a basic knowledge of the physics subject matter. A detailed description of the whole W is reported on the Project web site (<http://www.mis.unipa.it/handbook/item3/partner1/intro.html>), as well as the experimentation results

Here we will concentrate on the first phase concerning the analysis of pupils' mental models (MMs) about wave propagation. It has been divided into two sections where TTs were requested to attend different kinds of activities: a) to answer an open questionnaire, drawn from literature [16], where they were requested to describe, predict and explain some everyday wave phenomena; b) to analyse questionnaires and interviews administered to pupils in different countries and reported in literature, in order to draw some common conceptions, held by high school pupils, concerning the functioning of some wave phenomena.

## **3. Study description and methods**

### **3.1 Research questions**

The study here described was devoted at verifying:

- a) if the nature and level of the TTs' initial understanding of physic subjects were adequate to describe/explain everyday phenomena and develop the disciplinary competencies required by a teaching approach based on inquiry;
- b) if the knowledge of spontaneous models of pupils and of typical pupils' learning difficulties was considered by TTs a relevant competency for a teacher.

### **3.2 Participants, data collection and analysis**

Ten TTs (6 female, 4 male) attended the W activities. They were graduated in physics or mathematics and came, in couples, from the partner countries. TTs' disciplinary knowledge was heterogeneous, as 6 of them studied physics in their university curricula with a sufficient degree of deepening, while the remaining 4 attended just an introductory physics course during their university studies.

As pointed out by Kagan [17], a whole set of instruments is needed to capture the complexity of teachers' knowledge. A combination of approaches that can give detail about what teachers believe, what they know, what they do in class, and why, is necessary to verify PCK acquisition. With respect to the session on MMs we discuss here, we collected data from answers given by TTs to a questionnaire, from interviews and from observation reports regarding TTs' participation to the pedagogical activity. Data coming from the analysis of the teaching/learning sequence prepared by TTs at the end of the W were also taken into account,

in order to verify if the relevance of using pupils' MMs in teaching has been grasped by TTs during the W development.

Two researchers were involved in the study, administering in turn the pedagogical activities and recording questions and problems posed by the TTs, concerning physics content and pupils' MMs. Two "independent" observers participated to activities; they watched the pedagogical activities being not directly involved in the teaching/learning processes. They audio-taped and transcribed all activities, and interviewed TTs during and after the session, to go into detail about specific points of strength or weakness of the approach.

All data were analyzed independently by the two researchers, trying to reach a consensus when any disagreement was found during analysis. The focus was on the identification of regularities and patterns in questionnaire answers, observation and interview transcripts, in order to present a comprehensive analysis of TTs' participation to the session from several perspectives and to enhance the internal validity and reliability.

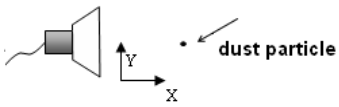
#### 4. Findings and discussion

The analysis of TTs' mental models about wave propagation has moved from the recalling of the theoretical model of the Educational Reconstruction and the introduction to the knowledge of pupils' mental models as a relevant point of a teacher professional knowledge. A class discussion has been developed, in order to clarify the meaning of the expressions "Common Sense Knowledge" and "Mental Models". Then, an open questionnaire drawn from literature [16] has been administered to TTs, where they were requested to describe, predict and explain some everyday wave phenomena.

TTs' written descriptions were classified in categories on the basis of a close reading of their explanations within a framework provided by domain-specific expertise. We identified TTs' mental models through the definitions supplied by their descriptions, as well as through the set of properties identified by TTs as characteristic of the analysed situations. Through triangulation we verified that model definitions came out from TTs' statements and were not imposed on them.

One of the questionnaire items is reported below. The item is followed by a table, resuming the typical answers given by TTs and the MMs evidenced by them, with their main characteristics. For more detail see [15].

##### ITEM 1

<p>A dust particle is located in front of a silent loudspeaker. The loudspeaker is turned on and plays a note at a constant pitch. Predict the motion of the dust particle and explain the reasons of your prediction.</p>	
--	---

Category	Characteristics	Typical answers (no. of TTs giving the answer)
MM_A - 1	No motion (sound propagation does not perturb the dust particle)	<i>Sound does not influence the dust particle which remains still (1)</i> <i>Dust particle continue to move randomly (sound does not influence it. (1)</i>
MM_B - 1	Forward motion (sound, or loudspeaker, pushes molecules in a forward direction as a sound wind)	<i>It moves forward due to loudspeaker push (4)</i> <i>It moves because waves push it forward (1)</i>
MM_C - 1	Oscillation (loudspeaker membrane produces vibration in	<i>The particle oscillates back and forth due to the motion of air molecules around it</i>

the air molecules, or dust particles, which oscillate forward and backward)	(3)
---	-----

In the second section, TTs have been made aware of some common conceptions, held by high school pupils, concerning the functioning of some wave phenomena. TTs analysed questionnaires and interviews administered to pupils in different countries, concerning the topic we were interested in. They analysed the explanations supplied by pupils and identified one (or more) representations/mental models that, in their ideas, were responsible of the different answers. TTs worked in groups of two, by following a prepared worksheet where they reported the pupils' answers and their inferences about the kinds of pupil Mental Model that could be responsible of such answers.

Another point deepened by the interviews in this section has been the TTs' initial perception of the usefulness for a teacher of the knowledge of pupils' mental models. The need to take into account pupils' spontaneous models during teaching was well acknowledged from the very beginning by the great majority of TTs. However, the personal experience of TTs can make such idea not so obvious; in fact, we want to evidence the attitude of one of the TT teams, whose components, when faced with the need to take into account common sense reasoning and pupils spontaneous models, clearly stated that taking into account these aspects of pupils' knowledge could distract teachers from their task.

*Q: do you think that searching for common sense knowledge models used by students and identifying their common reasoning strategies is useful for a teacher?*

*A: We are not used to doing this in our country. Learning that there is a whole branch of research devoted to this aspects of pedagogy was an interesting experience but we feel that a teacher should not bother to know what are the student's spontaneous models and, more generally, why she/he does not understand.*

*Q: Why do you think that a teacher should not take care why a student does not understand?*

*A: A teacher usually does not have time to stop her/his lesson and analyze all pupils' difficulties. ... the teacher simply has to teach and the student has to learn the subjects, substituting her/his wrong ideas with the scientific ones.*

This radical attitude was shown by both the members of the team. However, the analysis of the final teaching/learning sequence prepared by TTs and the observation reports of their apprenticeship activities in real classrooms pointed out that after the W these two TTs somehow modified their mind. Their TLS was planned by making an acceptable use of learning tools aimed at mixing up pupils in the pedagogical activities, orienting them towards an inquiry based approach and identifying as starting points some relevant pupils' learning difficulties identified in the previous phases of the section.

The analysis of all data collected in the session on MMs allow us to report the following considerations, with respect to 4 main aspects of our TT sample:

- 1) Only 3 TTs showed to possess mental models in good accordance with scientific ones. They were graduated in physics and had previously studied the subject of mechanical wave propagation, with particular attention to experimental, as well to modelling activities. 3 TTs showed a knowledge about wave propagation just adequate for

teaching but the remaining 4 evidenced naïve mental models, similar to those evidenced by pupils.

- 2) The analysis of pupils' answers has been actively performed by the majority of TTs, even if their initial personal beliefs were not resonant with the idea of listening to spontaneous models and common sense reasoning to build effective pedagogical activities. The analysis of TTs' final teaching/learning proposals have shown that more or less all of them have perceived that a major goal of scientific education is to link what pupils learn with their spontaneous conceptions and, more generally, with their everyday lives.
- 3) Only a few TTs were able to identify relevant learning knots of the subjects. The learning knot mainly identified was that many pupils think that sound is a thing (like a substance) propagating across the matter molecules.
- 4) All TTs participated with interest to the activities, but not all have been really engaged in the initial open questionnaire. In particular, two TTs, graduated in mathematics, did not show great interest in the test. When interviewed about their attitude, they answered that they never studied physics in depth; they were afraid that this could affect their answers and, for this reason, they were not answering to the questionnaire.

## 5. Conclusions

The analysis of data previously reported allow us to draw some conclusion with respect to our research questions. On the basis of the initial open questionnaire results and of the interviews and observations we can infer that the initial general subject-matter understanding of the majority of our TTs was not adequate to develop the disciplinary competencies required by teaching approaches focused on inquiry. Some TTs showed a good knowledge of mechanical waves, evidencing mental models about the subject in good accordance with scientific ones, but only a few were equipped with a deep knowledge of some significant factors which are considered relevant in influencing learning, such as: to encourage accurate observations of phenomena, to carefully plan experiments and to search for predictive explanations. Other showed a knowledge of mathematical laws but were not able to provide coherent explanations for their observations and ideas about how the world works.

The initial perception of teachers' understanding of students' common sense mental models as a salient feature of PCK that is important to develop was somehow mixed. 8 out of 10 considered relevant the knowledge of student learning difficulties and agreed on treating naïve conceptions as the starting point for effective teaching activities. Class discussion made evident their awareness of teaching as an activity addressed at coherently modifying naïve ideas, redirecting them towards scientific reasoning. Yet, two TTs evidenced poor initial attitude at reflecting on student learning difficulties and did not considered the understanding of students' spontaneous models as a really relevant PCK competency.

It must be taken into account that very often prospective teachers (and sometimes experienced teachers) show the same learning difficulties and representations of their future pupils. This fact points out the need to supply TTs with tools aimed at a deeper understanding of specific topics. Other results involving our W structure [2, 13, 14] have pointed out the importance of a TTs' thorough and coherent knowledge of subject matter. In our view, the value of PCK lies essentially in its relation with specific topics. Therefore, PCK is to be discerned from general pedagogical knowledge on the one hand, and from subject-matter knowledge on the other.

As the global results of our W show, the W organization supplies insight into the ways physics teachers can transform their knowledge of mechanical waves to stimulate pupil understanding of this topic as well as to gain a better understanding of the topic. The case study here described shows that to reflect on pupils' common sense mental models and to

compare these models with their own representations of phenomena supply TTs insight in identifying the crucial learning knots, by providing them with a knowledge base enabling to teach specific topics in more effective and flexible ways.

## References

- [1] Luera G.R. & Otto C.A., (2005). Development and Evaluation of an Inquiry-Based Elementary Science Teacher Education Program Reflecting Current Reform Movements, *J. Sci. Teach. Ed.* **16**, 241–258
- [2] Sperandeo-Mineo R.M., Fazio C. & Tarantino G. (2006): “Pedagogical content knowledge development and pre-service physics teacher education: a case study”. *Res. Sci. Educ.* **36**, 235-268
- [3] Calderhead, J. (1996). Teachers: Beliefs and knowledge. In D. C. Berliner & R. C. Calfee (Eds.), *Handbook of educational psychology*, 709–725, New York: Macmillan.
- [4] Viennot, L. & Raison, S. (1999). Design and evaluation of a research-based teaching sequence : the superposition of electric field. *Int. J. Sci. Educ.* **21**, 1-16.
- [5] Borko, H., & Putnam, R. T. (1996). Learning to teach. In D. C. Berliner & R. C. Calfee (Eds.), *Handbook of educational psychology*, 673–708, New York: Macmillan.
- [6] Shulman, L. (1986). Those who understand: Knowledge growth in teaching. *Educ. Researcher*, **15**(1), 4–14.
- [7] Shulman, L. S. (1987). Knowledge and teaching: Foundations of the new reform. *Harvard Educ. Rev.*, **57**(1), 1–22.
- [8] Park, S. & Oliver, J. S. (2008), Revisiting the Conceptualisation of Pedagogical Content Knowledge (PCK): PCK as a Conceptual Tool to Understand Teachers as Professionals, *Res. Sci. Educ.* **38**, 261–284
- [9] Duit, R. & Komorek, M. (1997). Understanding the basic ideas of chaos theory in a study of limited predictability. *Int. J. Sci. Educ.* **19**, 247-264
- [10] Duit, R. & Komorek, M. (2004). The teaching experiment as a powerful method to develop and evaluate teaching and learning sequences in the domain of non-linear systems. *Int. J. Sci. Educ.* **26**(5), 319-633.
- [11] Magnusson, S., Krajcik, J. & Borko, H. (1999). Nature, sources and development of pedagogical content knowledge. In J. Gess-Newsome and N. G. Lederman (eds.), *Examining pedagogical content knowledge* (pp. 95–132). Dordrecht, The Netherlands: Kluwer Academic Publishers.
- [12] Johnson-Laird, P.N. (1983). *Mental Models: Towards a Cognitive Science of Language, Inference, and Consciousness*. Cambridge: Cambridge University Press; Cambridge, MA: Harvard University Press.
- [13] Aiello-Nicosia, M. L., & Sperandeo-Mineo, R. M. (2000). Educational reconstruction of the physics content to be taught and pre-service teacher training. *Int. J. Sci. Educ.* **22**, 1085-1097.
- [14] Sperandeo-Mineo, R. M. & Fazio, C. (2008) Learning Physics via Model Construction: Issues and Experimental Results in *Science Education in the 21st Century* (I. V. Eriksson, Ed) Nova Publishers: Hauppauge NY (pp. 107-135)
- [15] Mis Project, (2010), <http://www.mis.unipa.it>
- [16] Fazio, C., Guastella, I., Sperandeo-Mineo, R.M. & Tarantino, G. (2008). Modelling Mechanical Wave Propagation: Guidelines and Experimentation of a Teaching Learning Sequence. *Int. J. Sci. Educ.* **30**, 1491-1530.
- [17] Kagan, D.M., (1990). Implications of research on teachers beliefs. *Educ. Psychol-US* **27**(1), 65-90



# Teaching-Learning about the physical basis of greenhouse effect and global warming in high school

Ugo Besson<sup>a</sup>, Anna De Ambrosis<sup>a</sup>, Pasquale Onorato<sup>a,b</sup>

<sup>a</sup> Department of Physics "A. Volta", University of Pavia, Via Bassi 6, I-27100 Pavia, Italy

<sup>b</sup> INFN, Laboratori Nazionali di Frascati, P.O. Box 13, 00044 Frascati, Italy

ugo.besson@unipv.it ; anna.deambrosisvigna@unipv.it

## Abstract

We present a research carried out with a group of six high school physics teachers on the implementation of a teaching learning sequence, designed by our research group, about the thermal effects of interaction between radiation and matter, infrared emission of bodies, greenhouse effect and global warming. We aimed to analyse the students' cognitive paths during the sequence and to study how a research based TLS is transformed in a specific teaching action for a particular class context.

## 1. Context and aims

This contribution deals with a work carried out with a group of six experienced high school physics teachers who analyzed and implemented in their classes a teaching learning sequence (TLS), produced by our research group, on the thermal effects of interaction between radiation and matter, infrared emission of bodies, greenhouse effect and global warming.

The context of the study is a Research Project, funded by the Regional Office of the Italian Ministry of Education and involving twelve teachers, aimed at introducing innovative contents and methods in the Mathematics and Physics curriculum in High School.

Our aims were:

- To study how a research based TLS is transformed in a specific teaching action for a particular class context
- To analyse the students' learning process, their cognitive paths, acquisitions and obstacles during the sequence and retained knowledge after sequence

Research has shown that the implementation of innovative sequences in the classroom generally implies a transformation of the original proposals, sometimes with the loss of important aspects of innovation (Pinto 2005) and that teachers' appropriation of a new approach is a long process (De Ambrosis & Levrini 2010). Our double level of analysis (of teachers' work and of students' responses) allowed single out some problems concerning the relationships among the original sequence project, the teacher's choices in constructing their own sequences and the students' understanding.

## 2. The sequence

The design of the sequence is based on a "three-dimensional approach", which involves a synergic integration of three aspects: a critical analysis of the scientific content in view of its reconstruction for teaching, an overview of current proposals (textbooks, common teaching), and an analysis of didactic research on the topic (Besson et al 2010a). The aim is to favour students' acquisition of the basic physics concepts necessary to understand the green-house effect on the Earth. The TLS aims also to bridge two areas, optics and thermal phenomena, strictly connected from a conceptual, scientific and technological point of view, but often taught separately in high school. It stresses the dependence of the optical properties of materials on the region of E.M. spectrum considered and the complexity of this dependence, as result of interaction between matter and radiation. For a detailed description of the sequence see (Besson et al 2010b).

### **3. Students' conceptions on the topic**

Few researches have been carried out about students' ideas on thermal effects of radiation and the existing ones are focalised on particular aspects. In particular:

- effects of radioactivity on living organisms (Rego & Peralta 2006, Lijnse et al 1990, Millar 1994, Lijnse & Klaassen 2004);
- interaction between radiation and metals involving atomic models and quantum theory (Redfors 2001).
- the greenhouse effect and global warming (Boyes et al 1993, Rye et al 1997, Anderson & Wallin 2000, Österlind 2005, Lester et al 2006, Kilinc et al 2008).

It was found, for example, that many students consider:

- the ozone layer depletion and radioactivity as causes of global warming and the skin cancer as an effect;
- the idea of 'trapping' of sun rays by atmosphere as explanation of the greenhouse effect.

Specific studies on student conceptions and teaching proposals for secondary school about radiation-matter interaction are still lacking. In our previous research we focused on some aspects of the problem (Besson et al 2010b). For example, we have found:

- a tendency to give absolute meaning to optical properties (transparency, absorptivity, emissivity) as intrinsic characteristics of bodies or materials,
- a lacking or incorrect consideration of infrared emission in thermal balances,
- a confusion between transitory phases and steady state situations,
- a difficulty in considering the interrelation of multiple factors and phenomena implied in energy balances.

Preliminary experimentation with small groups of students led us to specify a sequence of cognitive steps toward the construction of a coherent explanation of the greenhouse effect:

- 1) to recognize and explain a stationary condition of temperature for objects exposed to sun or lamp radiation;
- 2) to differentiate heat and radiation and recognize that objects emit thermal radiation;
- 3) to differentiate visible and infrared radiation and the behaviour of a material for visible and infrared (glass is transparent to visible but absorbs IR thermal radiation);
- 4) to put together the knowledge acquired in order to understand the radiative greenhouse effect in a box-model;
- 5) to understand the greenhouse effect on Earth and the global warming.

### **4. Organization of the work and data collection**

We met the teachers regularly about two times a month from September 2009 to April 2010. First meetings were devoted to a discussion of the TLS: contents and methods. Each experiment was carried out by the teachers in our laboratory and they acquired confidence in using sensors, data loggers and software. A first teaching plan was produced by each teacher and an initial questionnaire, common for all the classes, was prepared. Work sheets were designed by the teacher group to collect data on students' experimental activity: in particular predictions about the phenomenon to be studied, results obtained, comparison of the predictions with the results, comments and conclusions, relevant aspects of the experiment. A final questionnaire was prepared and administered to all students at the end of the class work. Video and audio taping of the class activities were also collected by the teachers as another data source and the followed path reported in a log book.

A considerable amount of data has been collected. The questionnaires and the worksheets filled in by the students in each class were first analyzed by the class teacher. All documents were uploaded in a web site devoted to the project and discussed in the periodical meetings.

In their final report the teachers also described which elements of the proposed sequence they

considered essential, how they passed from the research plan to their individual teaching plan and successively from their plan to the actual activity in classroom, and the results they observed at the end of the sequence.

### **5. Data analysis and first results**

According to the steps mentioned in section 3, data analysis was aimed to reconstruct the student cognitive progression towards:

- a distinction between concepts and phenomena initially confused in a global undifferentiated notion (heat, visible radiation, infrared radiation);
- a separation between properties of the objects and characteristics depending on interactions (transparency, absorptivity, color);
- the development of the concept of stationary condition in a non-equilibrium state, which is crucial for explaining many physical phenomena;
- the use of these acquisitions for a correct modeling and understanding of the greenhouse effect.

At the same time, we aimed to study how teachers appropriate and share the set of cognitive steps proposed in our sequence project and how this affects students' responses.

We will give here just some examples of the results for each step, together with general considerations on the teaching – learning process.

#### ***Step 1. To recognize and explain a stationary condition of temperature for objects exposed to sun or lamp***

In the pre-test and after, many students expressed the idea that

- the object increases its temperature indefinitely
- or up to its maximum possible temperature (depending on material)
- or until it is full of energy so that it cannot receive more energy which consequently flows out.

Analysing the path followed by the teachers we found two different cases:

- a) The sequence was introduced immediately after the study of thermal phenomena and started by typical experiments on thermal interactions (objects on a hot plate ...).
- b) The sequence was introduced just after waves and optics, while thermal phenomena were studied before, and started with experiments of cylinders exposed to a lamp light.

We observed that in the case a) most students interpreted the stationary condition of temperature as a thermal equilibrium with the environment:

*“when the object is at constant temperature it is in thermal equilibrium with the environment, heated by the lamp”;*

*“the bottles reach a thermal equilibrium with the environment ”*

On the contrary, in the case b) many students interpreted the stationary condition of temperature as a balance of absorbed and emitted radiation:

*“The temperature of the cylinders becomes constant when there is equilibrium between absorbed and given up radiation”.*

This difference seems to depend on what the teacher dealt with in the class just before starting the sequence (thermal interaction in the first class, optics in the second class) and at the beginning of the sequence. Students tend to automatically retrieve the rules just learned to explain the new problems.

#### ***Step 2. To differentiate heat and radiation and recognize that objects emit thermal radiation***

Some experiments comparing the behaviour of “clear” and “non clear” objects exposed to a lamp or sun helped students shift from explanations involving heat to explanations involving radiation:

*“the bottle does not heat up because it is transparent to the light; it lets the light go through”.*  
*“The glass cylinder let the rays go through then it reaches a lower temperature”.*

This was a new idea, addressing a characteristic differentiating radiation and heat: heat passes only by heating the material through which it passes, radiation passes only if it does not heat.

***Step 3. To differentiate visible and infrared radiation and the behaviour of a material for different kind of radiation***

Students observed the radiation spectrum of sources at different temperature and made experiments to “see the invisible” by means of a digital camera having infrared sensibility (for example they “saw” through a camera the IR radiation emitted by a remote control, see Figure 1).



Fig. 1. “Seeing” through a camera IR radiation emitted by a remote control

By using an infrared radiometer and inserting a layer of ‘clear’ glass or plastic between the object and the radiometer, students observed that most of the radiation emitted does not pass through the glass or plastic: *“IR radiation is absorbed by the glass”.*

Two teachers did not perform these two simple experiments and their students showed more incertitude in assuming the dependence of optical behaviour on the considered region of spectrum. There was probably an under-evaluation of the importance of this passage. In particular it was not enough stressed that if the glass layer absorbs IR radiation it heats up. It would have been useful to use evocative words, as for example “black”: glass is “black” for IR thermal radiation, while is transparent for visible radiation...

***Step 4. To put together the previous elements in order to understand the radiative greenhouse effect in a box-model***

The behavior of a small *box-model* of greenhouse was analysed by the students: a black aluminium plate was placed at the bottom of a plastic box and it was exposed to solar or lamp radiation, see Figure 2.



Fig. 2. The small box-model of greenhouse

The temperature of the plate was measured by means of a temperature sensor until the stationary condition was reached. The same measurements were repeated with a clear plastic lid on the top of the box. An interpretation of the experiment was presented by using a schematic drawing of the energy fluxes (in and out), in which an “ideal” lid was considered, which is transparent to all solar radiation and absorbs all thermal far infrared radiation.

Almost all students recognized that the black plate emits IR radiation and previewed a higher temperature for the box covered by the lid, and they explained this as a consequence of a decrease of the outgoing IR radiation energy.

Many students did not consider the radiation emitted by the cover toward the plate and toward the outside. Disregarding these emissions made it impossible for them to explain the stationary condition as a balance of energy fluxes in and out. So the fourth step was not completely accomplished by many students.

**Step 5. To understand the greenhouse effect on Earth and the global warming**

The passage from the box-model to the Earth greenhouse effect was not difficult and usually well understood, if the case of box-model was clear. This shows the effectiveness of the box-model and of the drawing schemata describing the energy fluxes (see figure 3).

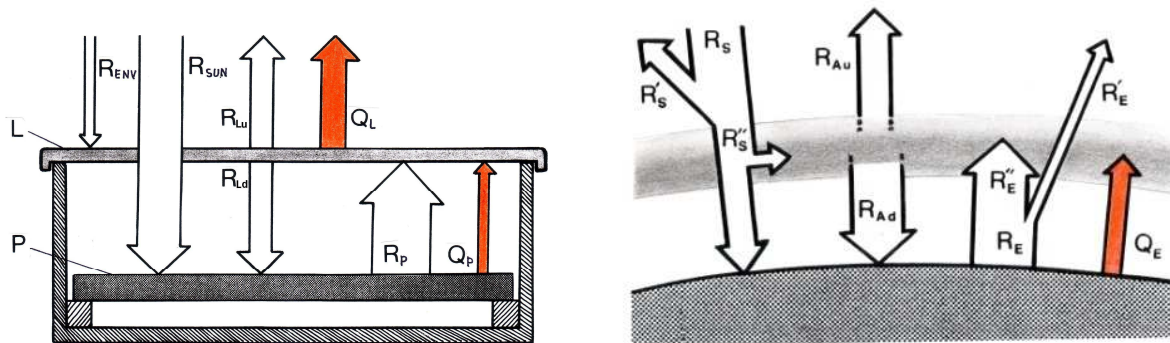


Fig. 3. Energy fluxes for the box-model and for a simple model of the Earth

Some teachers did not use, or did not sufficiently discuss these schemata with the students, and students' results are weaker on this point.

**6. Conclusions**

From previous analysis some results on students' learning path and on teachers' transformations and choices can be drawn.

*About students' learning path*

Results confirm the importance of passing through all steps, devoting time to each of them and returning on previous steps after a while in a different situation. Presenting the entire explanation of the greenhouse effect in a unique step is not effective; the phenomenon is complex and needs a progressive rapprochement.

The idea of stationary temperature as a consequence of a balance between entering and exiting energy was not spontaneously used by the students and was not mentioned by many of them in their explanations of the greenhouse effect after teaching.

Students did not spontaneously extend to IR radiation what they knew about visible light. In particular, the idea that if radiation is absorbed by an object the object heats up.

Students tended to consider only one factor at a time: energy absorbed or emitted, heat or radiation, choosing the unique factor according to the situation or to the main stress given by the teacher.

The kind of reasoning used by students was strongly influenced by the first presentation of the topic (examples, descriptions, approximations, explanations...), they tended to reuse the same initial pattern of reasoning, for the new situation even if not appropriate (as in the example concerning step 1). We call this tendency, observed also in other topics, the "imprinting" phenomenon in science learning (borrowing the term introduced by K. Lorenz for the behaviour of some birds). To avoid the "imprinting" effect it is useful to present since the beginning a wide panorama of different situations and factors, in a qualitative and simplified

manner, in order to convey an idea not limited to a particular aspect. For example, in introducing thermal phenomena it is useful to consider both situations of thermal equilibrium and stationary non equilibrium situations, in familiar simple cases.

#### *About teachers' transformations and choices*

The school situations were very different, so teaching plans and methods presented relevant differences, although respecting the core of the sequence project.

Four teachers first developed the theoretical basis concerning thermal phenomena and energy and then applied them to the situations proposed in the sequence, whilst two decided to use the problem of the greenhouse effect as a driving issue and motivation around which to build a basic theoretical knowledge concerning thermal phenomena. It is interesting that the second approach was chosen by the teachers of the classes with younger students (14-15 years).

In such classes teachers devoted much time to plenary discussions on the experimental results, by using qualitative reasoning, an intermediate terminology between common and scientific language, and examples and arguments directly referred to practical details of the performed experiences, following the students' need of staying very *near to facts* and at a low level of abstraction. On the contrary, in the higher grade classes (18-19 years), teachers stressed the connexions with theoretical developments, and in some cases used the analysis of experimental data as an occasion to develop a mathematical model (the exponential decay) useful in various physical situations and to apply mathematical concepts they were studying.

Faced to specific and unexpected students' difficulties and misconceptions, some teachers decided to insert new specific activities in order to surmount these obstacles, by means of new examples and/or analogical models.

Teachers enthusiastically accepted the experimental approach of the sequence and devoted a considerable amount of time to students' experimental activity. Nevertheless the emphasis given to the experimental work and the students' positive reactions to it made teachers put lower attention to the conceptual difficulties and to the passage from the understanding of single elements of the sequence to a global understanding of the greenhouse effect. In particular, the concept of energy balance and its crucial "structuring" role to interpret the phenomena in study were not sufficiently stressed. In some cases, pushed by students' demands and doubts, teachers emphasized details which did not play an important role and could distract from the fundamental conceptual path. For this reason, it is important to discuss with teachers clearly and explicitly about the role of different elements of the sequence: a core of contents, conceptual correlations and methodological choices, which are essential, and a cloud of elements that can be re-designed or skipped by teachers. This core-clouds structure (Besson et al 2010a) is useful both to permit teachers' changes and to control them.

#### **REFERENCES**

- Anderson B. and Wallin A. (2000) *Int. J. Sci. Educ.* **37**(10), 1096-1111.  
Besson U., Borghi L., De Ambrosis A. and Mascheretti P. (2010a) *Int. J. Sci. Educ.* **32**(10), 1289-1313.  
Besson U., De Ambrosis A. and Mascheretti P. (2010b) *Eur. J. Phys.* **31** (2010) 375-388.  
Boyes E. and Stanisstreet M. (1993) *Int. J. Sci. Educ.* **15**(5), 531-552.  
De Ambrosis A. and Levrini O. (2010) *Phys. Rev. Special Topics - Phys. Educ. Res.* **6**, 020107\_2010  
Kılınc A., Stanisstreet M. and Boyes E. (2008) *Int. J. Environ. & Sci. Educ.*, **3**(2), 89-98.  
Koulaidis V. and Christidou V. (1999), *Sci. Educ.*, **83**, 559-576.  
Lester B.T., Ma Li, Lee O. and Lambert J. (2006) **28**(4), 315-339.  
Lijnse P. L., Eijkelhof H., Klaassen C. and Scholte R. (1990) *Int. J. Sci. Educ.*, **12**(1), 67-78.  
Millar R., (1994) *Public Understanding of Science*, **3**(1), 53-70.  
Österlind K. (2005), *Int. J. Sci. Educ.*, **27**(8) 891-908.  
Pinto R. (2005) *Science Education*, 89, 1-12.  
Redfors A. (2001) *Int. J. Sci. Educ.*, **23**(21), 1283-1301.  
Rego F. and Peralta L. (2006) *Phys. Educ.*, **41**(3), 259-262.  
Rye J.A., Rubba P.A. and Wiesenmayer R.L. (1997) *Int. J. Sci. Educ.*, **19**(5), 527-551.



# Teacher change in exploring representational approaches to learning science

Peter Hubber, Deakin University, Australia

Email Contact: [phubber@deakin.edu.au](mailto:p hubber@deakin.edu.au)

## Abstract

The researchers worked with two experienced teachers in planning a series of three teaching sequences in the topics of force, substances and astronomy using a teaching approach that highlight representational issues and options in helping students explore and develop key conceptual understandings. Classroom sequences involving the two teachers were videotaped using a combined focus on the teacher and groups of students. Video analysis software was used to capture the variety of representations used, and sequences of representational negotiation. The teachers reported substantial shifts in their classroom practices, and in the quality of classroom discussions, arising from adopting a representational focus. From an epistemological perspective the teachers came to terms with the culturally produced nature of representations of force, substance and astronomy and their flexibility and power as tools for reasoning and communication, as opposed to their previous assumption that this was given knowledge to be learnt as an end point. From a pedagogical perspective the representational approach was acknowledged to place much greater agency in the hands of students, and this brought a need to learn to run longer and more structured discussions around conceptual problems.

## Introduction

The difficulties encountered by individuals in learning science point to the necessity for a very strong emphasis of the role of representations in learning. There is a need for learners to use their own representational, cultural and cognitive resources to engage with the subject-specific representational practices of science (Gee, 2004; Klein, 2006). Researchers who have undertaken classroom studies whereby students have constructed and used their own representations have pointed to several principles in the planning, execution and assessment of student learning (diSessa, 2004; Greeno & Hall, 1997). A key principle is that teachers need to identify big ideas, key concepts, of the topic at the planning stage in order to guide refinement of representational work. These researchers also point out the need for students to engage with multiple representations in different modes that are both teacher and student generated. A representation can only partially explain a particular phenomenon or process and has both positive and negative attributes to the target that it represents. The issue of the partial nature of representations needs to be a component of classroom practice (Greeno & Hall, 1997) in terms of students critiquing representations for their limitations and affordances and explicitly linking multiple representations to construct a fuller understanding of the phenomenon or process under study. The classroom practice should also provide opportunities for students to manipulate representations as reasoning tools (Cox, 1999) in constructing the scientifically acceptable ideas and communicating them.

## Research Methods and Question

The researchers worked closely with two experienced teachers, Lyn and Sally<sup>1</sup>, to plan teaching sequences that highlight representational issues in helping students explore and develop key conceptual understandings. This occurred initially over a 2 year period with sequences in the topics of forces, substances and astronomy. The planning sought to develop a model of classroom practice that foregrounds representational negotiation as a basis for conceptual growth. A forces topic was taught to Year 7 students (12 year-old) and the second and third topics on substances and astronomy were taught to the same students the following year. The lesson allocation to each topic sequence is given in Table 1; lessons lasted 45 or 90 minutes.

---

<sup>1</sup> Pseudonyms have been given to teachers in this study. Where reference has been made to names of students pseudonyms have also been used.

Table 1 Lesson allocation to each topic sequence

Date	Topic	Number of lessons
Sept. 2007	Forces	12
May 2008	Substance	14
Aug. 2008	Astronomy	12

### ***Research Question***

The research question was: how did teacher's practice and beliefs change and develop over time in response to an explicit representational focus in teaching science?

### ***Data Collection***

Data collected included: (1) video recordings of most classroom sessions and of student interviews; (2) student workbooks; (3) pre- and post-tests (for substances and astronomy topics only); (4) transcripts of tape recordings of teacher and (5) student interviews and researchers' field notes.

The videotaped lessons were coded using 'studiocode' software which has been designed for this type of analysis, to allow quick reference to representational events and instances of classroom negotiation of representations. The analysis reported here involved triangulation between video data, transcripts of student and teacher interviews, student work, pre- and post-tests and researcher field notes. Data reported in this paper include interpretive perspectives and examples from various contexts and settings.

### ***Approach to planning the topic sequences***

In coming into this study Lyn and Sally were experienced practitioners who were capable of innovative use of strategies based on the development of students' representations. Both teachers were biology trained and specialised in teaching this subject at senior levels of schooling but taught general science at junior levels. From this perspective the topics of forces, substances and astronomy were outside their main area of expertise.

The initial approach to planning the representationally focused topic sequence was similar for each of the three topics. The research team collaborated with the teachers in identifying big ideas or key concepts of the topic in addition to the students' alternative conceptions reported in the literature. The initial lessons in each teaching sequence focused on exploration of students' prior views, generation of students' representations, and introduction of the scientific conventions that underpinned each topic. Each teacher followed a similar sequence of activities, but in fact each was different in the way they introduced ideas, led discussions, and achieved some form of closure. To provide some insight into the specific approaches undertaken by the teachers the following cases of Lyn where she introduced concepts of force in the first of the three topics taught is given.

### **Case of Lyn – introducing forces**

What is described here is an outline of the first few lessons of the forces teaching sequence as taught by Lyn. The lessons are described as a series of sequenced stages.

#### ***Sequence stage 1***

Lyn began the sequence by developing in students an understanding of the term 'force', assisting them to construct meaning for force through their everyday language. She did this by initially eliciting from the students' everyday action words they used, given the task of changing the shape of a lump of plasticine. A brainstormed list of words was quickly constructed and displayed on the board, including *stretch, carve, twist, roll, squeeze, mould* and *poke*. Lyn used gestures to re-represent the words as they were given by the students. Many of the students also provided a gesture explicating their uttered word. This was a noticeable feature of the teachers' and students' communication during this topic, that gestures became an important part of describing and validating what was being represented in words or diagrams. Gestures were used to indicate pushes, pulls or lifting forces, to mime the size of forces, and to indicate the force's direction and points of application.

From the initial brainstorm listing Lyn re-represented the list into a tabular form after discussing with the students whether each of the elicited words could be placed into a column labelled 'push' or a



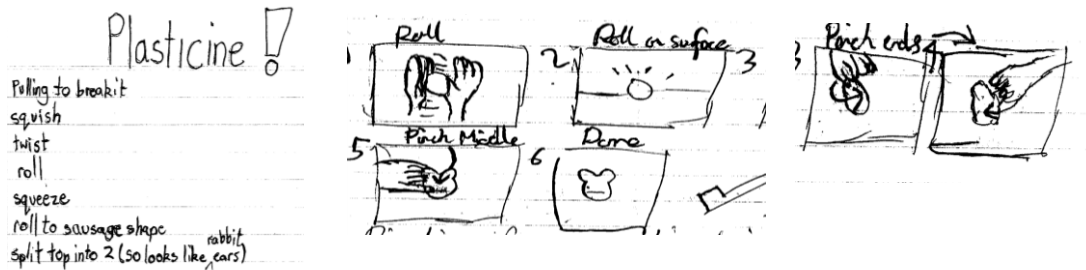
column labelled 'pull'. She then introduced the scientific meaning of a force as a 'push or pull of one object onto another'.

### Sequence stage 2

Lyn explored with the students various ways in which an everyday action or series of actions involving forces could be represented in a two dimensional form on paper. The students were given the one minute task of changing the shape of a handful sized lump of plasticine, and following this task, they were to represent their actions in changing the shape of the plasticine in paper form. The different representations constructed by the students, some of which are shown in Figure 1, were shared, discussed and evaluated within a whole class discussion.

Student 1

Student 2



**Fig. 1** Student representations of manipulating plasticine

One representation which had a series of figures with sequenced annotation (Figure 2 Image A) was unanimously accepted as providing clarity of explanation of the actions that were undertaken. This is illustrated by the following commentary extracted from a video segment:

Lyn: Which one of these representations worked well in explaining what was done?

Student 1: John's (image A) because it should you exactly what to do. Mine could have ended up anything.

Student 2: It (image A) was more visual, you can actually see it is easier to actually see what you did. With the other ones you could make it in different ways.

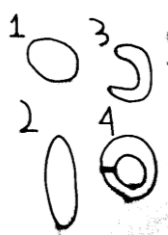


Image A

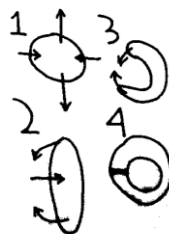


Image B

**Fig. 2** Reproduction of video images of John's representations

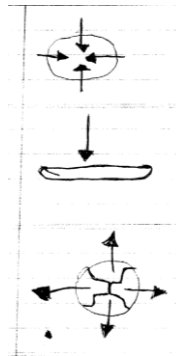
### Sequence stage 3

Lyn introduced force diagrams, which use the scientific convention of representing forces as arrows. She did this by discussing with the students the benefits in drawing arrows, to represent pushes and pulls, to John's drawings to enhance the explanations (Figure 2 Image B). The students were then given the task of re-representing their explanations of changing the shape of the plasticine in pictorial form using arrows (Figure 3).

Student 1

Action	Arrow Diagram
Rolling the Plastacine	
Squashing the Plastacine	
Tearing the Plastacine	

Student 2



Student 3



**Fig. 3** Students' use of arrows

The completion of this task produced different meanings of the use of arrows, which Lyn discussed with her students. Several issues were raised and discussed, and which included:

- Distinguishing between the arrow representation as a force or as a direction of motion;
- Distinguishing between different types of arrows, such as curved or straight, thick or thin, many or few.

#### *Sequence stage 4*

Lyn introduced the scientific convention of representing forces as straight arrows, when the base of the arrow is the application point of the force, the length of the arrow gives an indication of the strength of the force, and the arrow head indicates the direction of the force. The students were then encouraged to apply this convention to various everyday situations where forces are applied. Two examples of these include: (i) students were each given an empty soft-drink capped bottle and asked to represent the forces needed to twist off the bottle cap (Figure 4 Image A), (ii) students were given a piece of plasticine and asked to stretch the it with a gentle stretch and a rough stretch. They were then asked to use the arrow convention to represent a gentle, and a rough stretch on the plasticine (Figure 4 Image B).

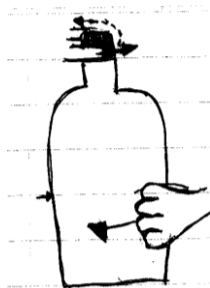


Image A

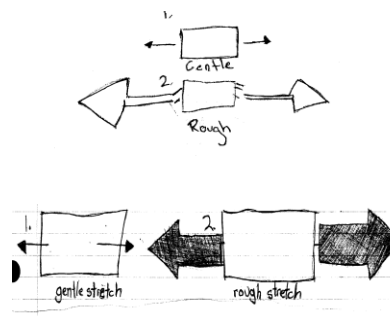


Image B

**Fig. 4** Student exploration of the arrow representation of force

### **Findings and conclusions**

In this study the teachers confirmed the efficacy of a representational focus in teaching and learning the key science concepts in the topics of force, substances and astronomy. The teachers reported substantial shifts in their classroom practices and beliefs in response to an explicit representational focus in teaching science. From a pedagogical perspective this approach was acknowledged to place much greater agency in the hands of students, and this brought a need to learn to run longer and more structured discussions around conceptual problems. Both teachers were very positive about this change in their teaching, and the video record showed increased confidence in guiding discussion over the three topics that were taught.

The teachers took more of a conceptual focus to topic planning moving away from a practice of covering curriculum content contained in the students' textbooks. In doing so the teachers sacrificed content coverage for the greater depth offered by this approach, and were unanimous that this change paid dividends in student learning.

*Lyn: Before we crammed it all in and didn't know what to cut out...we were so pleased to actually pause, particularly in that forces unit, which was so superficial and done so badly [in past years] according to the textbook that we were using. We were so pleased to go into depth. And it was so lovely to be able to develop ideas with the kids.*

The representational focus meant that the content to be covered was conceived of as an interconnected set of ideas linked by representations. This interconnectedness and a greater involvement of students in classroom interactions leads to a greater flexibility is required in terms of what content is to be covered each lesson. For the teachers this meant a change in their topic planning practices where they believe that planning for topics now involves preparing for possible changes in direction which result from current classroom interactions rather than following a fixed planning schedule which was their previous practice.

*Sally: ...you plan your lesson with a lot of possibilities. You think about okay what if the students ask me this question, what kind of activities can I have and I'm a little bit more prepared ...now way back, if I did this last year, I would've prepared a whole 5-week lesson and I'd be teaching it lesson, by lesson, by lesson. So that's the progression.*

From an epistemological perspective the teachers came to terms with the culturally produced nature of representations in the topics of force, substance and astronomy and their flexibility and power as tools for analysis and communication, as opposed to their previous assumption that this was given knowledge to be learnt as an end point. These realisations became empowering as they learnt to use representational challenges to drive classroom discussions and to achieve greater understandings themselves to interpret force and motion situations, apply particle ideas to explain properties of substances and interpret astronomical behaviour in terms of the interplay between simple dynamic systems of celestial objects. This meant that over the three topics the teachers enhanced their content knowledge and pedagogical content knowledge which was driven by undertaking the representational focus. The following quotes gives insight into the manner in which the teachers now perceived the role of representations in understanding science:

*Lyn: Sometimes the representation will help us to get to that knowledge. So it is a continuous feed-back; as Sally said, if we try to understand the concepts we have to go to various types of representations...Representations help us get the knowledge, we use the knowledge to help to build our representations.*

*Researcher: So is it two-way?*

*Lyn: A circle. The representations helped our knowledge and our knowledge helped our representations and the more representations helped our knowledge and the more knowledge helped our representations. So it was more a continuous feedback working.*

The teachers reported on the use of more modes of representation and over the period of the three topic sequence the teachers gained in confidence in setting representational challenges that led to significant representational activity.

*Lyn: I always used representations but particularly stronger for instructions and then I would just use visual representations...and now I use many different forms.*

The representational focus to the teaching of the three topics led the teachers to change in the manner in which they viewed the diagnostic, formative and summative aspects of assessment. In moving to a practice of employing diagnostic tests the teachers saw the knowledge gained from the test results as beneficial in terms of targeting the teaching in resolving misconceptions and for the students to be made aware of their own thinking as an important part of the teaching sequence. The teachers saw that the resolution to resolving the students' naïve conceptions as very much a representational issue in terms of the use of representational challenges to drive classroom discussions. The students were given many opportunities to interpret and generate representations which gave the teachers a good sense of the students' learning from a formative and summative perspective. By the third topic on

astronomy the teachers found that formative and summative assessment could be enhanced though providing spaces in the students' workbooks and tests to encourage the generation of representations. The connection of assessment and representations is summed up in the following quote by Lyn:

Lyn: ...*what you're seeing with representation is that you're seeing what's in their brain, not what they're regurgitating.*

The two teachers were strongly of the opinion that this representational focus had significantly impacted on student learning and engagement. Their perceptions of improved learning and engagement were central to their acceptance of change to their practices and beliefs.

Sally: *It's good to give them a representation, but it's more powerful when they re-represent it...it helps in their reasoning.*

## **Implications**

A key implication of the study is the need to shift practice in teaching science from its current focus on the delivery of content that is conceived of as resolved knowledge structures, to the pedagogical practices of this representation approach based on a discursive, more active view of knowledge and learning. This will require changes in conceptions of the role of the teacher in the science classroom, and changes in how knowledge and learning are thought of in science. To make this change, teachers need to:

- understand the role of representation in learning science, implying both a pedagogical and an epistemological shift;
- provide a representation rich environment and opportunities for students to negotiate, integrate, refine and translate across representations;
- make explicit to students the role of representation in learning science; and
- conceptualize learning in science in terms of students' induction into the representational conventions and practices of science and their capacity to coordinate these.

Given current concerns about the engagement of students in meaningful science learning, and the relatively limited success of pedagogical approaches based on cognitive views of learning, I would argue that this is an agenda that needs to be vigorously pursued both in research and policy.

## **References**

- Cox, R. (1999). Representation construction, externalized cognition and individual differences, *Learning and Instruction*, 9, 343–363
- diSessa, A. (2004). Metarepresentation: Native competence and targets for instruction. *Cognition and Instruction* 22 (3), 293-331.
- Gee, J.P. (2004). Language in the science classroom: Academic social languages as the heart of school-based literacy. In E.W. Saul (Ed.) *Crossing borders in literacy and science instruction: Perspectives on theory and practice*. Newark DE: International Reading Association and National Science Teachers Association.
- Greeno, J. & Hall, R. (1997). Practicing Representation: Learning with and about representational forms. *Phi Delta Kappan*, 78 (5), 361-368.
- Klein, P (2006). The Challenges of Scientific Literacy: From the viewpoint of second-generation cognitive science. *International Journal of Science Education*, 28 (2-3), 143 – 178.

# Quantity/potential-related elementary concepts in primary school teacher education

Federico Corni, Enrico Giliberti, Cristina Mariani

Faculty of Education, University of Modena and Reggio Emilia, Italy

federico.corni@unimore.it, enrico.giliberti@unimore.it, cristina.mariani@unimore.it

## *Abstract*

Primary school teachers need a training in physics robust enough to enable them to understand phenomena and new and complex situations they encounter as well as to answer the children questions and to design teaching activities. In initial teacher education, it must also be taken into account the limited scientific and mathematical background of students enrolling in university courses. Starting from an analysis of the misconception to construct a formal knowledge that teachers need to make then non-formal to teach children, is ineffective. One more appropriate way seems to be based on research in the fields of cognitive sciences that focuses on the simple structure of imagination that are used to interpret everyday phenomena.

The contents of the Physics course of the Degree in Primary Education of the University of Modena and Reggio Emilia have been structured in order to highlight the common conceptual structures, and the specific differences, between the various contexts of the discipline. The elementary concepts such as quantity, storage, capacity, potential, current and resistance have been clarified, differentiated and built qualitatively though rigorously through a series of examples taken from the everyday experience and known contexts. Analogy was introduced in the study of fluids, electricity, motion and heat, as a result of the use of the same elementary concept to interpret phenomena and processes.

In this contribution we present the structure and the contents of the course according to this approach, and the results of the analysis of the worksheets about motion filled by students.

## *Introduction*

One of the main effort in the training of primary school teachers is to develop some basic skills, both in the scientific understanding of the world and in the methodological abilities. Scientific concepts are usually not well developed in students at a degree level who are going to become primary school teachers, due to poor results in previous secondary school curricula.

Our proposal aims to develop an effective understanding of the physical phenomena coming from everyday life experience, but with a special focus on few elementary concepts and not relying on a large knowledge of scientific laws and principles, which, in most cases remain misunderstood and lead to misconceptions. To describe and explain the natural phenomena, a teacher has to rely on some elementary concepts, which have to be few, clearly identifiable and recognizable in different contexts. The same elementary concepts are suitable to be understood and employed by children, considering the different age levels, helpful for the didactical transposition and useful to plan and perform class activities. In this way the same understanding skills can be fostered in children, helping them to recognize elementary concepts in different contexts and situation, helping the use of some key-words expressing

the same concept, and forming a language with which children can compare their opinions and make predictions.

We found suitable to this approach the images at the basis of scientific thought identified within the theory of Force Dynamic Gestalts having the aspects of quantity or substance, quality or intensity, and force/power or energy [1]. The tools for this identification can be found mainly in cognitive linguistics, particularly in Talmy's [2] theory of embodied schemas of causation (called the theory of Force Dynamics by Talmy). Our effort is to connect both with the everyday experience and with the curriculum of primary school. In particular we focus on the elementary concepts of *quantity*, *difference of potential*, *capacitance*, *current*, and *resistance*.

To introduce and discuss about elementary concepts, analogy is often used. However, it is worth distinguish between the use of an analogy as a way to understand an unknown phenomenon by projecting a known context, and the recognition of analogies among contexts due to the application of the same elementary concepts. In the first case analogy is a knowledge tool (analogical thought), in the other case it is a support for the thought based on elementary concepts.

In this paper we analyze the training activities carried on with students attending the second year of the degree course for Primary School Teachers in 2009. The activities took place during a 5-weeks/30 hours course and were performed as a series of 3 paths on the contexts of water, electricity and motion, respectively. The last path about motion, assumed to be the most difficult one, is analyzed here to highlight the role of elementary concepts and of analogy in describing and understanding motion-related phenomena.

### ***Research questions***

Our research is devoted to the role of FDG as basis for scientific description and interpretation, pointing out advantages and disadvantages related with their use. We are investigating if and how the FDG of quantity, quality and force-power can be a base for a scientific understanding of phenomena at the level of primary school, both for teachers and for pupils.

In this paper in particular we try to answer the following research questions referred to students of the degree course for Primary School Teachers:

Are FDG-related elementary concepts adequate for students becoming primary school teachers? Are some elementary concepts more useful than others?

### ***The experimentation***

The main goal of the training activities is to introduce and to develop the use of elementary concepts such as *quantity*, *difference of potential*, *capacitance*, *current*, and *resistance* applied to different contexts, suitable both for students understanding and for their future teacher work.

The paths consisted, according to the Prediction-Experiment-Comparison (PEC) cycle, in performing series of ex-cathedra experiments, preceded by individual motivated prediction, followed by comparison of the prediction with the results, and, eventually, correction. The three paths have been preceded by an introduction of the elementary concepts with reference to everyday life phenomena and from contexts not directly connected to the "scientific world".

### 1) *Introduction of the elementary concepts*

The aim of the activity was to recall and differentiate the elementary concepts with reference to everyday experience, helping to recognize these concepts as already part of student's knowledge.

The concept of *quantity* have been analyzed in relation to many different examples of countable and mass substances (e.g. people or water) and students have been asked to propose their own examples.

Then a distinction with the concept of *intensity* (corresponding to the generalized concept of potential) was made: the idea that some qualities can be linked with a quantity, such as height of books in a library, water pressure etc.. Related with the previous two is the concept of *capacitance*, expressing how a quantity changes its quality when disposed into a container, or, complementarily, how a container affects the quality of a contained quantity (e.g. water in different types of container).

The concept of *difference of potential* followed: quality level difference is the driving force for quantity motion (e.g. water under pressure difference). Then the concept of *current* expresses the amount of quantity per unit time that passes through a certain point (e.g. people that passes through a door). Finally, the concept of *resistance* has been introduced as the control parameter for the current.

### 2) *Didactical path about fluids*

The second activity aimed to explore the context of fluids, here water, using the elementary concepts introduced in the first activity to predict, describe and understand 15 simple experiments arranged into a path (see [3] where the same sequence of experiments is reported, together with the following electricity path). Before the experimental activity, students have been asked to situate the elementary concepts of quantity, difference of potential, current, capacitance and resistance, giving a description with words and with a drawing.

The concepts were introduced in the following order:

- 1) difference of levels of two free water surfaces (pressure difference) as driving force for water flow
- 2) communicating vessels in equilibrium state and in water dynamic conditions
- 3) current as the amount of water that flows through a section of a pipe per unit time; the rotation velocity of a fan as a measure of current and level of a free water surface as a measure of local pressure
- 4) resistance (due to pipes, connections and fans) and its effect on current

### 3) *Didactical path about electricity*

The third activity aimed to recall the same elementary concepts seen during the previous activities and using them to explain experiments in a context, such electricity, which we suppose that few students were familiar with. Concepts were introduced following the same sequence of the previous activity, but more emphasis was placed on quantity and its potential, because electricity was not directly observable and the potential had to be measured by means of a voltmeter. Besides, new words had to be introduced to identify some "objects", unusual for the majority of the students, such as the battery, the voltmeter, the conductors, the "open" and "closed" circuit.

The concepts were introduced in the following order:

- 1) difference of potential as driving force for current flow;
- 2) electrical potential distribution in open and in closed circuits;
- 3) current as the amount of electricity that flows through a section of a wire per unit time; the intensity of the light of a lamp as a measure of current;

4) resistance (due to wires, connections and lamps) and its effect on current.

4) *Didactical path about motion*

The fourth activity aimed to explore a context, probably encountered by most of the student in secondary school, but which is not dealt with in terms of FDG elementary concepts. Momentum corresponds to the elementary concept of quantity.

The experiments were made by means of a low friction rail on which carts could move and hit each other. The collisions between the carts occurred either through a spring (that leaves the two carts separated) or using an adhesive strip (that makes the two carts connect and proceed together). Students were also requested to draw an analogous situation in the water context.

The steps of the path were slightly different from the ones for water and electricity. Table I reports the list of the experiments with a sketch for every experiment in which the meter represents the velocity.

**Table I.**

Step #	Situation	Sketch of the initial and final situation
1	The cart 1 (on the left) arrives with a certain speed and hits, by means of a spring, the cart 2 (on the right) which stands still	
2	As #1 but with a adhesive strip	
3	As #2 but with cart 2 having double mass	
4	As #2 but with cart 1 having double mass	
5	As #1 but with cart 1 having double mass	
6	A compressed spring on the cart is released, with no contact neither with another cart nor the wall	
7	A compressed spring is released between two bodies of same mass which stand still	
8	As #7 but with the two bodies moving initially at a certain speed	



9	As # 7 but with cart 1 having mass double than cart 2	
10	As #8 but with cart 1 having a mass double than cart 2	
11	As # 7 but with cart 2 having mass double than cart 1	
12	As #8 but with cart 2 having a mass double than cart 1	
13	As #6 but with the relaxed spring pushing against the wall	
14	As # 13 but with the rail over two cylinders allowing it to slide	
15	As # 1 but with two magnets instead of the spring	

The idea of conservation has been taken into account, with special care to the identification of the system in which the total amount of momentum is a constant (insulated system). The total amount of momentum can be zero, but also in this case we can make the bodies move by introducing an amount of energy by means of a compressed spring (positive and negative momentum).

The velocity represents the generalized potential for motion: momentum is spontaneously transferred from the body with higher velocity to the body with lower velocity.

The concept of capacitance as the “container” of momentum is represented by the inertial mass: bodies with greater mass acquire and lose a certain amount of momentum modifying their speed less than bodies with lower mass.

The current is the rate of transfer of momentum from one body to another, that corresponds to the concept of force. Collisions mediated by different springs or magnets facing poles of the same kind transfer the same amount of momentum in different time intervals. Resistance is a less relevant concept for what concerns motion.

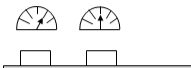
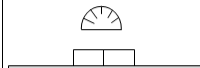
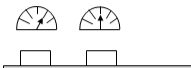
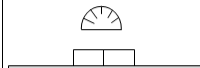
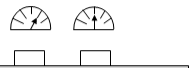
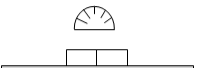
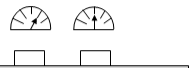
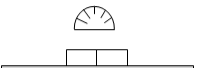
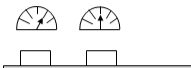
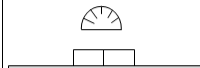
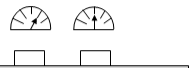
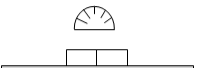
### ***Data analysis***

In this paper we analyze in particular the worksheets of the last of the four activities, the path about motion, in which students had to identify the elementary concepts in the specific context, and then, for every step, to write the following elements:

- a description of the experiment
- the prediction about the phenomenon

- the reason for the prediction, using the elementary concepts
- the explanation of the phenomenon in terms of cause-effect
- after the experiment, in case, the correction of the prediction explaining where and why it was wrong.

Figure 1 shows the structure of the worksheet for every experiment of the path.

A MOVING CART WITH A STRIP HITS A STILL CART.		CORRECTION.							
<table border="1" style="width: 100%; border-collapse: collapse;"> <tr> <td style="width: 50%; text-align: center;">INITIAL SITUATION </td> <td style="width: 50%; text-align: center;">SITUATION AFTER THE COLLISION (FILL IN) </td> </tr> <tr> <td style="text-align: center;">ANALOGOUS SITUATION IN THE WATER CONTEXT</td> <td style="text-align: center;">ANALOGOUS SITUATION IN THE WATER CONTEXT</td> </tr> </table>	INITIAL SITUATION 	SITUATION AFTER THE COLLISION (FILL IN) 	ANALOGOUS SITUATION IN THE WATER CONTEXT	ANALOGOUS SITUATION IN THE WATER CONTEXT	<table border="1" style="width: 100%; border-collapse: collapse;"> <tr> <td style="width: 50%; text-align: center;">INITIAL SITUATION </td> <td style="width: 50%; text-align: center;">SITUATION AFTER THE COLLISION (FILL IN) </td> </tr> <tr> <td style="text-align: center;">ANALOGOUS SITUATION IN THE WATER CONTEXT</td> <td style="text-align: center;">ANALOGOUS SITUATION IN THE WATER CONTEXT</td> </tr> </table>	INITIAL SITUATION 	SITUATION AFTER THE COLLISION (FILL IN) 	ANALOGOUS SITUATION IN THE WATER CONTEXT	ANALOGOUS SITUATION IN THE WATER CONTEXT
INITIAL SITUATION 	SITUATION AFTER THE COLLISION (FILL IN) 								
ANALOGOUS SITUATION IN THE WATER CONTEXT	ANALOGOUS SITUATION IN THE WATER CONTEXT								
INITIAL SITUATION 	SITUATION AFTER THE COLLISION (FILL IN) 								
ANALOGOUS SITUATION IN THE WATER CONTEXT	ANALOGOUS SITUATION IN THE WATER CONTEXT								
PREDICTION OF THE RESULT OF THE EXPERIMENT		PREDICTION OF THE RESULT OF THE EXPERIMENT							
SYNTHETIC JUSTIFICATION TRYING TO USE THE ELEMENTARY CONCEPTS		SYNTHETIC JUSTIFICATION TRYING TO USE THE ELEMENTARY CONCEPTS							
CAUSE	EFFECT	CAUSE	EFFECT						
1			2						

**Figure 1.**

Our assumption is that the elementary concepts show their power and effectiveness if they are able to help students to describe phenomena, to make predictions, to modify their point of view, to help correcting their answer. The motion context is suitable because it is very close to everyday experience, source of possible (well-known) misconceptions, and apparently far from the idea of being interpreted in terms of FDG elementary concepts.

For the analysis we focus on: the more used concepts; the more useful ones for understanding; which ones lead to misconceptions or which are helpful to avoid them; if some concepts, such as capacitance, help students in making quantitative predictions.

The available data refer to 35 students that began to fill in the worksheets in the classroom during the execution of the experimental steps and that had the opportunity to finish the work at home.

### ***Results and discussion***

Results are discussed referring to some topics, taking into account the number of students and, where needed, the number of steps of the path relevant for that topic.

#### ***1) Quantity***

Momentum, as the product of mass and velocity, is identified as the quantity from all the students. This is a good result considering the traditional way of treating motion at secondary schools in terms of kinematical quantities (position, velocity and acceleration) separated from mass.

Very high results the average number of steps (78%), 10.9 (standard deviation 3.2) over 14 (all steps except the 6<sup>th</sup> one), in which students explicitly refer to transfer and conservation of momentum, meaning that momentum is consistently identified as a quantity not only at the

level of definition. Within the incorrect answers, the most frequent error (though in some cases it could be a problem of language) is the transfer of velocity.

In 4 steps (7, 9, 11, 13) the carts are placed motionless in the centre of the rail in contact through a compressed spring and made move in opposite direction after the release of the spring. 14 students over 35 (40%) introduce correctly the idea of negative momentum, that's to say the idea of motion direction. Among these, the average of steps over 4 in which students express this concept is 2.1 (53%).

To avoid the idea of "creation" of momentum, students, due to their weak mathematics background that makes it difficult to introduce the minus sign, chose to compare the momentum of one mass with that of the other, and even, sometimes, express quantitative relations.

## 2) Potential

The velocity is identified as the (generalized) potential by 26 students over 32 (81%). Some of the students that do not identify the velocity as the potential, report a formal but abstract definition ("level of motion"), 1 student uses "difference of motion" and 2 students use "difference of speed of the two carts after the collision".

## 3) Capacitance

The capacitance concept referred to inertial mass is explicitly used in the interpretation of the 10 experiments (steps 2, 3, 4, 5, 9, 10, 11, 12, 13, 14) in which carts of different masses are considered in an average of 7.1 (standard deviation 2.2) cases (71%) per student. In the direction of increasing this value, we expect that sometimes students would not repeat the explanations given to quite similar experiments in sequence.

## 4) Current

11 students over 34 (32%) make considerations on the current of momentum, evidencing the role of the time interval required for the transfer process, and 12 students over 34 (35%) explicit the conceptual correspondence between the momentum transfer through a spring between the two carts (step 1) and the momentum transfer through the magnetic field of two magnets facing poles of the same kind mounted on the two carts (step 15). It is a good result, considering that the concept of current was never mentioned in other parts of the path and the difficulty in distinguishing the two different ways in which momentum is displaced: owned by a moving cart and transferred between two carts through a collision.

## 5) Quantitative considerations

An index of effectiveness and utility of the elementary concepts is evidenced by the inclination of student to make quantitative considerations.

Quantitative considerations in predictions or explanations could be made in 8 non trivial situations (case of carts with different masses in steps 2, 3, 4, 5, 9, 10, 11, 12). 33 over 35 students (94%) made quantitative considerations, even if not explicitly requested. They made on average 2.7 over 8 (34%) quantitative considerations, with an individual percentage of correctness of 85%. This result must be related to the poor scientific bases of the students and to their dislike to use any mathematical relation even in easy situations.

The two students who made more incorrect quantitative considerations (S26: 3 over 8, 38%; S30: 3 over 5, 60%) are the ones who made superficial and not organic use of the elementary concepts within the path steps.

4 students made wrong predictions because of mathematical mistakes or, more likely, incorrect use of the mathematical language (for example "the speed is reduced to 1/3" instead of "the speed is reduced by 1/3").

## **Conclusions**

Are FDG-related elementary concepts adequate for students becoming primary school teachers? Are some elementary concepts more useful than others?

The FDG-related elementary concepts, due to the high fraction of positive cases, result adequate for students of the degree course for Primary School Teachers. The most useful concepts to explain phenomena related with motion are: quantity, potential and capacitance. These concepts are acquired and used from most of the student and seem to be able to predict and explain phenomena in which motion is transferred, also in case of different masses involved, and also making use of quantitative relations expressed by means of words. Finally, it is worth taking into account that the FDG-related elementary concepts of *quantity*, *difference of potential*, *capacitance*, *current*, and *resistance* in educational courses for their basic character and general validity, as well for the simplicity of their transfer into educational paths for pupils.

## **References**

- [1] Fuchs H.U. (2009), "Figurative Structures of Thought in Science An Evolutionary Cognitive Perspective on Science Learning", Talk presented to the General Assembly of the Conférence des directeurs de gymnase de Suisse Romande et du Tessin, Mendrisio, September 18, 2009
- [2] Talmy, L. (1988), "Force Dynamics in language and cognition", *Cognitive Science*, 12, p. 49-100
- [3] Mariani C., Corni F., Altiero T., Bortolotti C., Giliberti E., Landi L., Marchetti M., Martini A., "Experiments and models for physics learning in primary school", in "Physics Community and Cooperation: Selected Contributions from the GIREP-EPEC & PHEC 2009 International Conference", Ed. D Raine, C Hurkett, L Rogers (Lulu/The Centre for Interdisciplinary Science, Leicester, 2010), p. 137-151

# **DEVELOPING TECHNOLOGICAL PEDAGOGICAL CONTENT KNOWLEDGE IN PRE-SERVICE SCIENCE TEACHERS THROUGH MICROTEACHING VIA INQUIRY BASED INTERACTIVE PHYSICS COMPUTER ANIMATIONS**

**Mehmet Fatih Tasar**, Gazi University, Turkey  
**Betül Timur**, Gazi University, Turkey

## **1. Introduction**

The turn of the 21<sup>st</sup> century marked the beginning of a much common and widespread use of computer technologies in science classrooms and practically everywhere else because personal computer hardware with ever higher capacities became affordable to larger populations and applications with enhanced visual characteristics were created with lesser effort not only by computer experts but also by science educators. Although not sufficient for all teachers, several initiatives and efforts emerged in order to help science teachers to better understand the associated teaching methodologies and benefits of Computer Assisted Teaching (CAT) in science.

Using technology in science classes requires teacher competences in technology. Teachers need to have a coherent knowledge about content, pedagogy and technology. Pre-service and in-service science teachers need to develop technological pedagogical content knowledge of the most effective ways to teach various science concepts, principles, and now how to create a technology rich environment.

## **2. Science Teachers' Technological Pedagogical Content Knowledge (TPCK)**

Technological pedagogical content knowledge (now known as TPCK or TPACK) has become a commonly referenced conceptual framework of teacher knowledge for technology integration within teacher education. TPCK is described as complex interaction of content, pedagogy and technology and discussion of successful integration of technology into instruction (Koehler & Mishra, 2008).

In recent years researchers described TPCK within the framework Schulman's (1987, 1986) description of pedagogical content knowledge (PCK). According to Schulman (1986, p.9) PCK "goes beyond the knowledge of subject matter per se to the dimension of subject matter knowledge for teaching" and PCK is the connection and relation of pedagogy and content knowledge. Table 1 shows PCK conceptualizations of ten scholars.

**Table 1 Components of pedagogical content knowledge from different conceptualizations (Vandirel, Verloop & Vos, 1998; Park & Oliver, 2008)**

Scholars	Knowledge of								
	Purposes for teaching a subject matter	Student understanding	Curriculum	Instructional strategies and representations	Media	Assessment	Subject Matter	Context	Pedagogy
Schulman(1987)	d	PCK	d	PCK	u	u	d	d	d
Tamir (1988)	u	PCK	PCK	PCK	u	PCK	d	u	d
Grossman (1990)	PCK	PCK	PCK	PCK	u	u	d	u	u
Marks (1990)	u	PCK	u	PCK	PCK	u	PCK	u	u
Smith and Neale (1989)	PCK	PCK	u	PCK	u	u	d	u	u
Geddis et al. (1993)	u	PCK	PCK	PCK	u	u	u	u	u
Fernandez et al. (1995)	PCK	PCK	u	PCK	u	u	PCK	PCK	u
Magnusson et al. (1999)	PCK*	PCK	PCK	PCK	u	PCK	u	u	u
Hasweh (2005)	PCK	PCK	PCK	PCK	u	PCK	PCK	PCK	PCK
Loughran et al. (2006)	PCK	PCK	u	PCK	u	u	PCK	PCK	PCK

PCK: Author(s) included this subcategory as a component of PCK  
d: Author(s) placed this subcategory outside of PCK as a distinct knowledge base for teaching.  
u: Undiscussed subcategories  
\*Researchers in science education refer to this component as one's "orientation toward teaching"

Researchers conceptualized PCK in the domain of teaching with technology under different schemes: “Margerum-Lays and Marx (2003) referred to PCK of educational technology, Slough and Connell (2006) used the term technological content knowledge, and Mishra and Koehler (2006) suggested the term technological pedagogical content knowledge (TPCK) – a comprehensive term that has prevailed in the literature” (as referred to and cited in Angeli & Valanides, 2009, p.155). TPCK can be described as how teachers understand educational technologies and PCK interacts with technology to produce effective teaching with technology.

Some scholars emphasize that TPCK is more than simply interaction knowledge of pedagogy, technology and technology domains. In more specific detail, Niess (2005) elaborated on TPCK extending Grossman’s (1990) four central components of PCK. Niess proposed that teachers exhibit TPCK when they demonstrate an overarching concept of what it means to teach a particular subject in which technology is integrated into learning; knowledge of instructional strategies and representations for teaching specific topics with technology; knowledge of students’ understandings, thinking, and learning with technology in a particular subject; and knowledge of curricula and curriculum materials that integrate technology with learning in specific subject area (Niess, 2005).

Conceptualization of TPCK by Niess was adapted Magnusson, Krajcik and Borke’s (1999) conceptualization of PCK. In this study we will focus on five components of TPCK;

1. Purposes and goals of teaching a specific content with technology (Orientation to teaching with technology) (OTTE)
2. Knowledge of instructional strategies and representations for teaching specific topics with technology ;(ISTE)

3. Knowledge of students' understandings, thinking, and learning with technology in a particular subject ;(SUTE)
  4. Knowledge of curricula and curriculum materials that integrate technology with learning in the subject area (CUTE)
  5. Knowledge of assessment with technology (ASTE)
- Formal analysis of the qualitative data was conducted using the framework of TPCK as a guide.

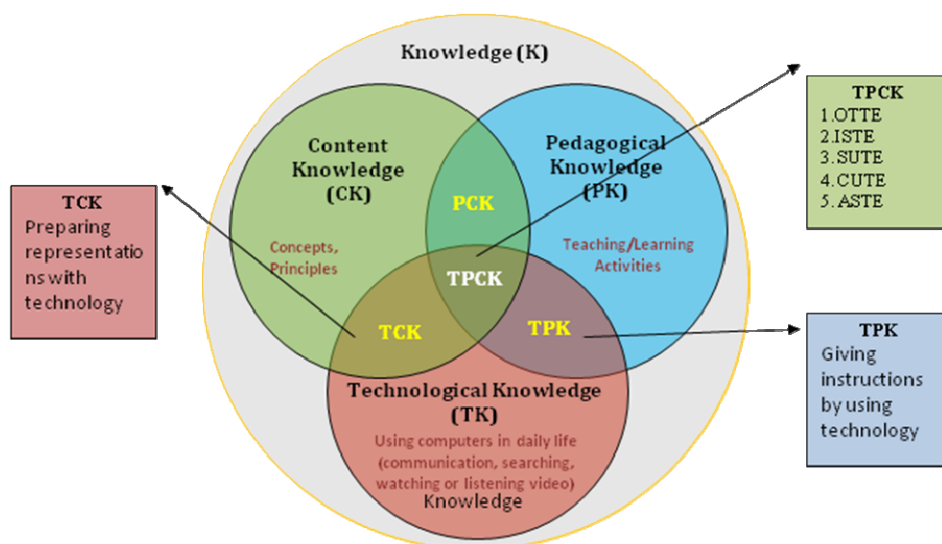


Figure 1. An expanded model of TPCK (adapted from Koehler and Mishra, 2006; conceptualization of TPCK Magnusson et. al. 1999)

### 3. Aim of the Study

This study is conducted to explore the development of technological pedagogical content knowledge (TPCK) of sophomore pre-service science teachers in a computer course during 2010 spring term through microteaching.

### 4. Research questions

1. What is the perceived confidence level of pre-service science teachers' related to the four TPCK constructs before and after microteaching (i.e., TK, TPK, TCK, TPCK)?
2. What changes in components of technological pedagogical content knowledge occur as pre-service teachers participate in microteaching?

### 5. Methodology

In order to determine pre-service science teachers' development of TPCK both quantitative and qualitative research methods was used in this study. This research is a multiple case study based on a mixed methods research design.

One-group pretest-posttest design was used to examine the TPCK development. The quantitative data was collected by "TPACK in Science Survey (TPACKSS)" developed by Graham, Burgoyne, Cantrell, Smith, Clair and Harris (2009). The survey adapted to Turkish and its Cronbach's alpha was calculated .95. It was administered to 38 pre-service

science teachers as pre and post tests. Quantitative data were triangulated by pre-post interviews, observations during microteaching, artifacts (lesson plans, microteaching feedback surveys (consist of open ended questions), and technology enriched science modules) of 8 pre-service science teachers.

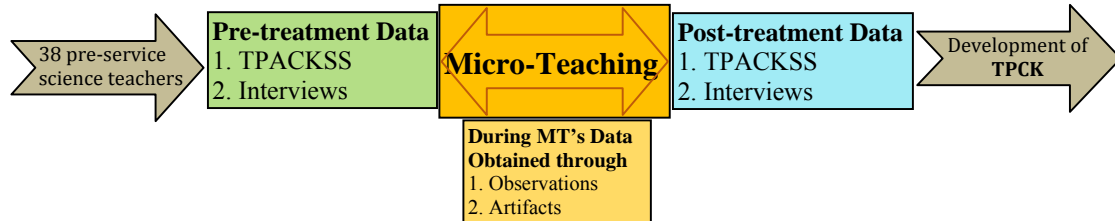
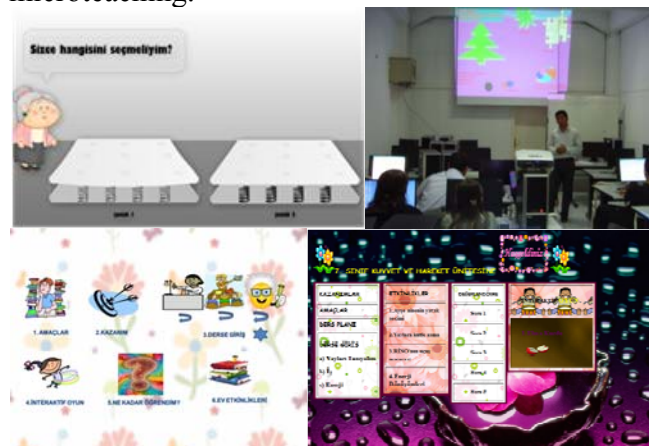


Figure 2. Formulation of the research study in terms of quantitative and qualitative data collection

During computer course microteaching (MT) was used to examine the development of TPCK of pre-service science teachers'. In micro teaching 8 pre-service science teachers taught 6<sup>th</sup>, 7<sup>th</sup> and 8<sup>th</sup> grade “Force and Motion” units and its topics from the primary curriculum via inquiry based interactive physics computer animations (IBIPCA). Class size of pre-service science teachers (N=38) participated in the study in their senior years. During MT the class is grouped into small groups and each group has a computer in order to run the module. Teaching to a group of students enrolled in a primary curriculum subjects provide a situated learning environment for the pre-service science teachers to experience teaching with technology. The MT took place 8 weeks.

#### Microteaching

The microteaching focused the pre-service teachers on gaining teaching experience in teaching physics with technology. The pre-service teachers were expected to develop a science module which includes interactive animations about their physics topic, teach (videotaping the instruction) their lessons to their peers, and take reflections on the lessons using the videotapes from their peers and the instructor. All pre-service teachers made lesson plans before microteaching.



Picture 1 Animation about springs (1<sup>st</sup>), Pre-service teacher is microteaching (2<sup>nd</sup>), Sample Modules (3<sup>rd</sup>, 4<sup>th</sup>)



## 6. Findings

To address the question of perceived confidence level of pre-service science teachers' related to the four TPCK constructs they were asked, "How would you rate your own confidence related to task associated?" as a pre and post test. Thirty-one items along the areas of technological knowledge (TK), technological pedagogical knowledge (TPK), technological content knowledge (TCK), and technological pedagogical content knowledge (TPCK) of these areas were asked, and the scale for answering consisted of 5 points of confidence.

**Table 1 Descriptive statistics for all items on the pre- and post-survey as well as mean increase for each item.**

Survey Items (N=38)	Pre-Survey		Post-Survey		Post-Pre
	Mean	SD	Mean	SD	Mean
TPCK1	2.74	.98	3.63	.49	.89
TPCK2	3.00	.87	3.79	.53	.79
TPCK3	3.37	.94	3.58	.64	.21
TPCK4	3.32	.99	3.69	.62	.37
TPCK5	3.29	.96	3.77	.49	.48
TPCK6	3.34	.99	3.66	.58	.32
TPCK7	3.18	.95	3.71	.61	.53
TPCK8	3.11	.95	3.58	.76	.47
<b>Average</b>	<b>3.17</b>		<b>3.67</b>		<b>.51</b>
TPK1	3.47	1.08	3.66	.58	.19
TPK2	3.39	.97	3.69	.62	.30
TPK3	3.26	1.18	3.79	.58	.53
TPK4	3.40	1.03	3.76	.54	.36
TPK5	3.50	1.08	3.84	.64	.34
TPK6	3.42	.89	3.89	.46	.47
TPK7	3.24	1.08	3.84	.68	.60
<b>Average</b>	<b>3.38</b>		<b>3.78</b>		<b>.40</b>
TCK1	3.13	1.21	3.39	.68	.36
TCK2	2.87	1.38	3.55	.69	.68
TCK3	2.82	1.33	3.55	.69	.73
TCK4	3.16	1.48	3.55	.55	.39
TCK5	2.98	1.46	3.42	.55	.44
<b>Average</b>	<b>2.99</b>		<b>3.49</b>		<b>.72</b>
TK1	4.00	1.27	4.08	.63	.08
TK2	4.08	1.02	4.11	.56	.03
TK3	3.56	1.16	3.92	.54	.36
TK4	3.53	1.22	3.90	.65	.37
TK5	3.42	1.15	4.08	.59	.66
TK6	3.03	.99	3.76	.49	.73
TK7	3.16	1.15	3.68	.62	.52
TK8	3.61	1.05	3.68	.57	.07
TK9	2.95	1.04	3.87	.58	.92
TK10	2.48	1.13	3.40	.75	.92
TK11	2.71	.90	3.39	.68	.68
<b>Average</b>	<b>3.32</b>		<b>3.81</b>		<b>.49</b>

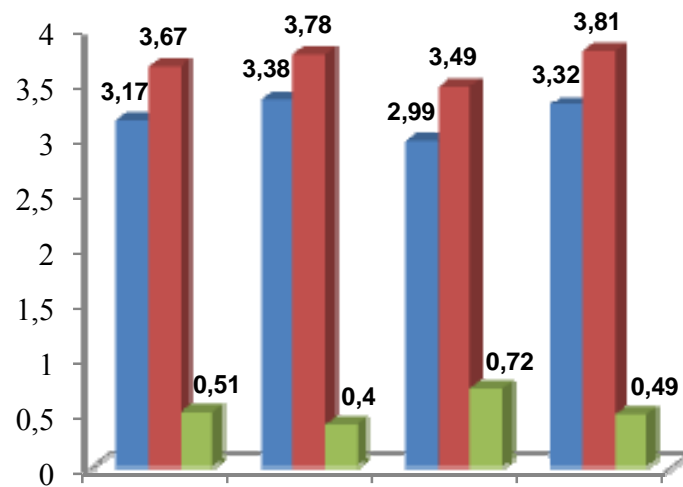


Figure 3 Average mean of pre-survey, post-survey, and increase in TPCK confidence (n=38).

For each of the survey items descriptive statistics including means and standard deviations calculated. Table 1 shows mean increase and pre mean minus post mean for each item. The data from the survey indicates that pre-service students have low TPCK confidence at the beginning and after microteaching pre-service students have high level of TPCK confidence. TK confidence increased greatest followed by TCK, TPCK and TCK. This finding indicates and reinforces that knowledge of TK is foundational knowledge of TPCK framework.

In TPCK framework technological knowledge (TK) is knowledge about using technologies such as computers, mobile phones, technological content knowledge (TCK) is preparing representations with technology in order to explain a specific concept or principle, technological pedagogical knowledge (TPK) is giving instructions by using technology for motivating learners, and technological pedagogical content knowledge (TPCK) is making representations with technology in order to explain a specific concept or principle and also using it in an instruction for facilitating learning with special instructional methods. Also from the responses of pre-service students to survey, second highest score was TPK confidence that means pre-service teachers know how to incorporate technology and pedagogy as well. Vice versa, TCK confidence of pre-service teachers was the lowest. This finding is supported by quantitative data; pre-service teachers asserted during the interviews they don't know how to incorporate technology and content.

**Table 2 Results of Paired-Sample t-Tests for Factors of Technological Pedagogical Content Knowledge**

<b>Sub-survey (N=38)</b>	<b>Mean</b>	<b>SD</b>	<b>t</b>	<b>df</b>	<b>p</b>	<b>ES</b>
Pre-TPCK	25.34	5.70	4.23	37	.000*	0.325
Post-TPCK	29.39	3.27				
Pre-TPK	23.68	5.57	3.37	37	.002*	0.234
Post-TPK	26.47	2.78				
Pre-TCK	14.95	5.48	6.07	37	.016*	0.498
Post-TCK	17.47	2.71				
Pre-TK	36.50	6.93	5.37	37	.000*	0.438
Post-TK	41.87	3.07				
Pre-Survey	100.47	18.50	5.39	37	.000*	0.439
Post-Survey	115.21	8.59				

\*Significant at the .05 level.

Pre and post means values were calculated for four TPCK constructs. For the paired sample t-test, results indicate significant increase for all constructs (see table 2). This means pre-service science teachers TPCK confidence improved as compared to pre test. Effect sizes included in Table 2 were calculated for all significant results and are in a generalized form as the ratio of  $t^2 / t^2 + (n_1+n_2 - 2)$ . Effect sizes of approximately .01 are considered to be small, while .06 are moderate and .14 or above are large (Büyüköztürk, 2002, p. 45). In this study calculated effect size is large ( $ES > .14$ ) for sub-scales and for whole the survey and sub-surveys.

To address the question of changes in technological pedagogical content knowledge occur as pre-service teachers participate in microteaching qualitative data was used. Pre and post interviews, observations during microteaching and artifacts (lesson plans, microteaching feedback surveys, and technology enriched science modules) were analyzed according to five components of TPCK.

### *1. Purposes and goals of teaching a specific content with technology (Orientation to teaching with technology) (OTTE)*

We analyzed the interviews, videos, microteaching feedback surveys and lesson plans of 8 pre-service teachers to find out why pre-service science teachers use technology while they are teaching physics subjects. At pre interviews pre-service science teachers asserted that they don't tend to use technology when teaching a physics subject. Because they think using technology requires special competences. Also most of the interviewed students asserted that they hadn't been taught any physics subject with technology before. Also, before their microteaching they asserted that they hadn't come up any educational software or animation about physics. In conclusion, at the pre interviews they couldn't tell the aim of technology for teaching physics. At the post interviews they asserted that, using technology for teaching physics is to make subjects tangible and to make students active participation. One pre-service student told about the aim of using technology for teaching physics;

*When I teach acceleration, my aim is to use technology to make abstract subject concentrate. Also when I used my module as teaching acceleration, my other aim is to make acceleration clearer to students with active participation of students by interactive computer animations.*

Also in their microteaching feedback surveys they asserted the aim of the technology is to facilitate abstract subjects to students' understanding.

## *2. Knowledge of instructional strategies and representations for teaching specific topics with technology ;(ISTE)*

At pre interviews all 8 pre-service teachers asserted that technology is an instructional strategy for teaching physics. They do not use any instructional strategies while instructing with technology. One of the reasons for this can be that; they are not used to learn any physics subject with technology. One pre-service student asserted that;

*When I am using technology in my instruction for instance when I am using a power point presentation, according to me making a presentation during instruction is an instructional strategy. So I don't use any instructional strategies while I am instructing with technology.*

Moreover, during their microteaching pre-service teachers used different kinds of instructional strategies with technology. For instance they especially used inquiry-based teaching strategy while they are instructing. Also they asserted at the post interviews, active learning instructional strategies should be used in order to support active student participation in physics, when teaching a physics subject with technology. At microteaching feedback surveys they gave different kind of instructional strategies for using with technology during instruction as; discussion, brain storming, question and answer methods.

## *3. Knowledge of students' understandings, thinking, and learning with technology in a particular subject ;(SUTE)*

This component of TPCCK means knowledge of students' learning difficulties with technology. In microteaching pre-service teachers focus on their teaching rather than their peers understandings, thinking, and learning. In the interviews they asserted that students have learning difficulties with mass and weight, work and energy, force and pressure, float and remain in suspense, gravitational potential energy and potential energy. However, when pre-service teachers' were asked to define these words at the interviews they had also difficulties when they are defining the meaning of these words. In addition when they were instructing these words in microteaching to their peers most of them memorized or read the meaning of these words from the presentation. These means learning difficulties are resistive to change.

## *4. Knowledge of curricula and curriculum materials that integrate technology with learning in the subject area (CUTE)*

At the pre interviews pre-service teachers asserted that they don't know any curriculum materials in physics to integrate with technology. Most of them used to prepare power point

presentations but they have not experienced to teach any science topic with technology. Also they asserted that they haven't come up against any educational software or animation, simulation about any science topic. But after microteaching they created interactive modules which include animations, videos, and simulations. At microteaching feedback surveys they asserted that pre-service teachers have to have technological competences to integrate technology in their instruction. But during their university education they didn't have any lesson or training about how to integrate technology into science curriculum. Additionally they asserted that teaching physics with technology is enjoyable, easy and permanent.

#### *5. Knowledge of assessment with technology (ASTE)*

At the pre interviews pre-service teachers asserted that they know traditional and alternative assessment but they don't know how to do an assessment with technology. On the other hand, in their modules they made interactive test, puzzles, and games to assess students. During microteaching most of pre-service teachers' made competitions as an assessment and used interactive test, puzzles, and games as an assessment tool. In addition, at microteaching feedback surveys most of the pre-service teachers asserted that assessing students with technology especially with interactive games is very enjoyable and motivational.

In conclusion, quantitative data supported that pre-service science teachers' knowledge of; goals of teaching a specific content, addressing students' difficulties and misconceptions, instructional strategies and methods, curricular materials and assessment of a particular concept with technology developed during the semester.

### **7. Conclusions**

There was significant improvement between pre and post scores on all of the TPACK constructs computer self-efficacy belief. According to the paired-samples t-test, results indicate a significant increase for all constructs of TPCK. Also qualitative data supported that pre-service science teachers' knowledge of; addressing students' difficulties and misconceptions, instructional strategies and methods, curricular materials and assessment of a particular concept with technology developed during the semester. In consequence, it is ascertained that TPK, TCK and TK are interrelated with TPCK and must be investigated together with TPCK.

Also, this study indicates that it is possible to design suitable technology rich environments to address, and develop, pre-service teachers' knowledge components suggested by the TPCK framework. Nevertheless, science teacher preparation programs need to consider guiding student teachers to develop technological competences, to combine technology, pedagogy and technology before graduation.

**Acknowledgements:** This study was financed by 7<sup>th</sup> Framework of European Union Research Projects EC contract GA 234870 S-TEAM (Science Teacher Education Advanced Methods).

## References

Angeli, C. & Valanides, N. (2009). Epistemological and methodological issues for the conceptualization, development, and assessment of ICT-TPCK: Advances in technological pedagogical content knowledge (TPCK). *Computers & Education*, 52, 154-168.

Büyüköztürk. Ş. (2002). *Sosyal bilimler için very analizi el kitabı*. Ankara: Pegem-A Yayıncılık.

Enochs, L. G., Riggs, I. M., & Ellis, J. D. (1993). The development and partial validation of microcomputer utilization in teaching efficacy beliefs instrument in a science setting. *School Science and Mathematics*, 93(5), 257-263.

Graham, C. R., Burgoyne, N., Cantrell, P., Smith, L., St. Clair, L., & Harris, R. (2009). TPACK Development in Science Teaching: Measuring the TPACK Confidence of Inservice Science Teachers. *TechTrends*, 53(5), 70-79.

Grossman, P. L. (1990). *The making of a teacher: Teacher knowledge and teacher education*. New York: Teachers College Press.

Koehler, M., & Mishra, P. (2008). Introducing TPACK. In AACTE Committee on Innovation and Technology (Eds.), *The handbook of technological pedagogical content knowledge for teaching and teacher educators* (pp. 3-29). Mahwah, NJ: Lawrence Erlbaum Associates, Publishers.

Magnusson, S., Krajcik, J. & Borke, H. (1999). Nature, sources and development of pedagogical content knowledge for science teaching. In J. Gess-Newsome and N.G. Lederman (Eds.), *Examining Pedagogical Content Knowledge* (pp. 95-132). Dordrecht, The Netherlands: Kluwer Academic Publishers.

Niess, M. L. (2005). Preparing teachers to teach science and mathematics with technology: Developing a technology pedagogical content knowledge. *Teaching and Teacher Education*, 21, 509-523.

Park, S. & Oliver, J.S. (2008). Revisiting the conceptualisation of pedagogical content knowledge (PCK): PCK as a conceptual to understand teachers as professionals. *Research in Science Education*, 38 (3), 261-284.

Shulman, L. S. (1986). Those who understand: Knowledge growth in teaching. *Educational Researcher*, 15(2), 4-14.

Shulman, L. S. (1987). Knowledge and teaching: Foundations of the new reform. *Harvard Educational Review*, 57(1), 1-22.

Riggs, I. M., & Enoch L. G. (1990). Toward The Development of an Elementary Teachers' Science Teaching Efficacy Belief Instrument. *Science Education*. 74 (69), 625-637.

Van Driel, J. H., Verloop, N. & De Vos, W. (1998). developing science teachers' pedagogical content knowledge. *Journal of Research in Science Teaching*, 35 (6), 673-695.

# IDENTIFYING PRE-SERVICE PHYSICS TEACHERS' MISCONCEPTIONS WITH THREE-TIER TESTS

Derya Kaltakci<sup>1,\*</sup> and Ali Eryilmaz<sup>2</sup>

<sup>1</sup> Department of Secondary Science/Math. Education, Middle East Technical University, Ankara, Turkey, [kaderya@metu.edu.tr](mailto:kaderya@metu.edu.tr)

<sup>2</sup> Department of Secondary Science/Math. Education, Middle East Technical University, Ankara, Turkey, [eryilmaz@metu.edu.tr](mailto:eryilmaz@metu.edu.tr)

## Abstract

In order to measure individuals' conceptions, different diagnostic tools have been developed and used such as; interviews, multiple choice tests, concept maps, and multiple-tier tests (two tier tests and three tier tests). Among these tools, interviews have advantages as flexibility and obtaining in-depth information. However; interviews can be conducted on limited number of individuals. Multiple choice tests can be administered to a large number of individuals; but cannot investigate the students' responses deeply. In order to compensate the limitations of interviews and the ordinary multiple choice tests, researchers extended multiple choice tests into two or three-tier tests. With the application of three-tier tests to determine misconceptions, researchers can obtain rich information about the individuals' misconceptions eliminated from lack of knowledge and errors.

Some previous research studies draw attention to the teachers as a possible source of student misconceptions. For this reason, identifying teachers' and teacher candidates' misconceptions become crucial to better understand the ones of students'. In the present study, three different three-tier concept tests on geometric optics, simple electric circuits and force and motion were administered to 30 senior pre-service physics teachers at Middle East Technical University (METU) in Turkey to analyze their misconceptions. For each of the three topics, common misconceptions measured by each of the tests are listed. Pre-service physics teachers' misconceptions in all three topics is analyzed and presented for one, two and three tiers separately in terms of percentages of each misconception.

## Introduction

Misconceptions are stable, unscientific conceptions that obstacle the real learning of individuals (Kaltakci & Didis, 2007) and Hammer (1996) listed the properties of misconceptions as:

- 1) Misconceptions are strongly held and stable cognitive structures,
- 2) Differ from expert conception,
- 3) Affect how students understand scientific explanations,
- 4) Must be overcome, avoided and eliminated to achieve expert conception.

For this reason, identification and elimination of misconceptions about several science concepts is a popular research area in educational research. In order to identify and measure students' misconceptions different diagnostic tools have been developed and used. Interviews, multiple choice tests, concept maps and multiple-tier tests can be listed as diagnostic tools for misconceptions in science education. Each of these tools has some advantages as well as disadvantages over the others.

---

\* On behalf of Department of Secondary Science/Math. Education, Kocaeli University, Kocaeli, Turkey

Interviews provide in-depth information about the students' cognitive structures and reasoning by its probing and flexibility. Several interviewing techniques have been used such as Piagetian Clinical Interviews (PCI) (Piaget as cited in White & Gunstone, 1992), Interview-About-Instances (IAI) (Osborne & Gilbert, 1979), Interviews-About-Events (IAE) (Osborne & Gilbert, 1980), Prediction-Observation- Explanation (POE) (White & Gunstone, 1992), Individual Demonstration Interview (IDI) (Goldberg & McDermott, 1986, 1987), Teaching Experiment (TE) (Katu, Lunetta, & van den Berg as cited in Komorek & Duit, 2004). However interviews as diagnostic tools have certain disadvantages as can be conducted on limited number of individuals.

For overcoming the disadvantage in interviewing, diagnostic multiple choice tests (Treagust & Haslam as cited in Chen, Lin, & Lin, 2002) that can be immediately scored and applied to a large number of subjects have been used to ascertain students' conceptions. These tests have been used either following in-depth interviews or alone. However these tests cannot investigate the students' responses deeply. In literature there exist several examples of multiple choice tests developed by Linke and Venz, Tamir, Trembath (as cited in Chen et al., 2002), and Hestenes, Wells and Swackhamer (1992).

Ordinary multiple choice tests with one-tier were criticized in overestimating the students' wrong answers. Because, some of these wrong answers of students may not be due to students' misconceptions, but due to lack of knowledge or error. In order to eliminate the limitation of one-tier tests, two-tier tests developed by researchers. Treagust (1985) and Chen et al. (2002) developed two-tier tests with ordinary multiple choice question in the first tier and asking the reasoning in the second tier. Eryilmaz and Surmeli (2002) developed a three-tier test about heat and temperature and in their test in addition to the first two tiers they asked students' confidence about their answers in the third-tier. Afterwards, three tier tests used by many other researchers (Aydin, 2007; Kutluay, 2005; Peşman, 2005; Türker, 2005).

The main sources of students' misconceptions are categorized as the students' personal experiences, textbooks, language used, and teachers. Since teachers have a crucial influence on students' learning, an effective pre-service and in-service teacher education process becomes important. For this reason one of the aims of this study is to identify misconceptions of pre-service physics teachers on the topics of "Geometric Optics", "Force and Motion", and "Simple Electric Circuits" with three-tier misconception tests to guide effective teacher education attempts in future. The second aim of the study is to give information about three-tier misconception tests.

## **Methodology**

### **Population and Sample**

In order to analyze pre-service physics teachers' misconceptions on three topics: "Geometric Optics", "Force and Motion", and "Simple Electric Circuits", a cross sectional survey study was conducted on 30 senior pre-service physics teachers with 11 girls (37%), 19 boys (63%) at Middle East Technical University (METU) in Turkey. The target population of the study was all senior pre-service physics teachers at METU (approximately 40 students).

### **Instruments**

Three three-tier misconception tests from literature were used for this study. These are Geometric Optics Misconception Test (GOMT) (Kutluay, 2005), Force and Motion Misconception Test (FMMT) (Turker, 2005), and Simple Electric Circuits Misconception Test (SECMT) (Pesman, 2005).

In the development of the three-tier tests, a certain process is followed. Firstly, semi-structured interviews with participants similar to the intended sample of the test are done. At



this step, common misconceptions on the topic are determined, it gives time to think to the participants, to elaborate on their answers and reasoning, and also gives an opportunity to the researcher to obtain an in depth information. After the interviews, open-ended tests are developed and administered to get greater generalizability and to create the distracters of the three-tier tests. After analyzing the results of open-ended tests, three tier-tests are developed. In the development process, the interview results and the misconceptions found in literature are also taken into account. All of the instruments are developed for high school students in Turkey. The validity and reliability analysis are done by the researchers. In this present study however, these three tests are administered to pre-service physics teachers who are going to be teachers at high schools in future. The three different three-tier misconception tests were administered during an approximately 30-35 minutes each on different days.

### **Data Analysis**

In order to analyze misconceptions with three tier tests a descriptive statistical analysis conducted with percentages. For the validity of the test scores three quantitative techniques are used. Firstly, correlation between test scores on the first two tiers and confidence levels on the third tiers are determined to establish construct validity. Since if the test is effective, it is expected that students with higher scores on first two tiers would be more confident about the correctness of their answers (Çataloğlu, 2002). As a second method for validity, factor analysis method is used to determine whether there are one or more clusters of items on the test scores. Thirdly, probabilities of false positive and false negatives are estimated for content validity. False positive is defined as Newtonian response chosen with a non-Newtonian reason. False negatives, on the other hand, are non-Newtonian response that is chosen by Newtonian thinker. False negatives are considered unproblematic and attributed to the carelessness or inattention. According to Halloun and Hestenes (1995), the probability of false negatives should be less than 10%.

In the analysis of a three-tier test, if a student chooses incorrect choice in the first tier, then chooses incorrect reasoning in the second tier and sure about the responses in the first two tiers, then the student is considered to have misconception. Other responses are attributed to either errors or lack of knowledge.

### **Results**

The GOMT, FMMT, and SECMT measures the pure misconceptions of pre-service teachers which are eliminated from lack of knowledge and errors with three tiers. In the first tiers of the tests pre-service teachers are asked about the concepts, in the second tiers they are asked to explain their reasons in the first tiers, and in the third tiers they are asked to what degree they are sure about their given responses in the first two tiers. With this way of measurement, each distracter in the multiple choice test corresponds to a misconception listed previously. Each categorized misconception is determined by the selection of one or more related distracters of several items from the test. However different from a one or two tier test in a three tier test we can determine pure misconceptions. Table 1 shows the misconceptions measured by the GOMT, the items that correspond to these misconceptions, percentage of pre-service teachers having each misconception from the present study, and the percentage of

Table 1 Comparison of Misconception Categories for High School Students and Pre-service Teachers for the All Three tiers of GOMT

Misconceptions (Items)	% of Preservice (N=30)	% of High School (N=141)
<b>M1</b> Light colored objects can be seen in total darkness since they emit light. (1.1.a, 1.2.e, 1.3.a) (12.1.a, 12.2.b, 12.3.a)	4	10
<b>M2</b> There will be black rays in the total darkness. (1.1.b, 1.2.a, 1.3.a) (12.1.a, 12.2.e, 12.3.a)	3	13
<b>M3</b> Eyes can get used to seeing in total darkness. (1.1.c,d, 1.2.b, 1.3.a) (12.1.a, 12.2.d, 12.3.a)	3	23
<b>M4</b> Light travels a different distance depending upon whether it is day or night. (2.1.a.,2.2.a,f,g, 2.3.a) (2.1.b, 2.2.b,c,e, 2.3.a)	0	31
<b>M5</b> Light is emanating in only one direction from each source, like flash light beams. (3.1.b, 3.2.b, 3.3.a) (5.1.a, 5.2.b, 5.3.a)	17	17
<b>M6</b> Shadows of the objects are clearer when the bigger bulb is used as a light source. (3.1.b, 3.2.a, 3.3.a) (4.1.a, 4.2.b, 4.3.a)	20	30
<b>M7</b> Shadow belongs only to the non-luminous object and it always looks like the object. (5.1.a,b,d, 5.2.c, 5.3.a)	3	19
<b>M8</b> Students claim that there will be no shadow even if a light source and a non-transparent object exist together. (5.1.e, 5.2.a, 5.3.a) (6.1.a, 6.2.e, 6.3.a)	7	7
<b>M9</b> In the region of geometrical overlap there would be either lightness (full illumination) or darkness (shadow). They did not consider semi darkness and treated the shadow as the presence of something. (6.1.b, 6.2.b, 6.3.a) (6.1.d, 6.2.a, 6.3.a)	10	17
<b>M10</b> Shadow is black color and light is white color. When they overlap, they mix and form the grey color. When the shadow and light overlap, the shadow reduce the brightness of the light. (6.1.c, 6.2.d, 6.3.a)	27	30
<b>M11</b> To see an image of any object, it should be inside the front region straight ahead of the mirror. (7.1.c, 7.2.c, 7.3.a) (15.1.b, 15.2.b, 15.3.a)	0	12
<b>M12</b> Students think that an image in a plane mirror lies behind the mirror along the line of sight between a viewer and the object. (7.1.a, 7.2.a, 7.3.a) (11.1.a, 11.2.d, 11.3.a) (13.1.b, 13.2.a, 13.3.a) (15.1.b, 15.2.c, 15.3.a) (16.1.b, 16.2.c, e, 16.3.a)	73	18
<b>M13</b> An observer sees the object because the observer directs sight lines toward it, with light possibly emitted from the eyes. (7.1.b, 7.2.e, 7.3.a) (11.1.a, 11.2.b, 11.3.a) (15.1.a, 15.2.a,d, 15.3.a) (8.1.a, 8.2.f, 8.3.a)	27	18
<b>M14</b> Confuse image formation with shadow formation. In the presence on an illuminant the position and size of the image of an illuminated object depends on the illuminant. (8.1.a, 8.2.g,h, 8.3.a) (8.1.b, 8.2.ab,c,, 8.3.a) (8.1.c, 8.2.c, 8.3.a) (9.1.a, 9.2.a,b,c, 9.3.a) (9.1.b, 9.2.d,e, 9.3.a)	10	23
<b>M15</b> The position and size of the image of any object depend on the location of the observer. When the observer retreats size and position of the observer is changed. (10.1.a, 10.2.a,b,c, 10.3.a) (10.1.c, 10.2. k, 10.3a)	7	21
<b>M16</b> Image of a black object on the mirror was due to black rays bouncing off the black object. (11.1.a, 11.2.a, 11.3.a)	7	14
<b>M17</b> Creating images are an inherent attribute of the silvery mirror material, rather than the product of the reflection process. The students say that “The mirror reflects and so the person sees”. (12.1.a, 12.2.c, 12.3.a)	7	10
<b>M18</b> While watching an object its position also shifted as they viewed it from different perspectives. They misunderstand that the absolute position of the object remains the same as an observer moves. (13.1.b, 13.2.a,d, 13.3.a)	10	25
<b>M19</b> Image of any object is located right ahead of the observer. (13.1.b, 13.2.b,f, 13.3.a) (16.1.b, 16.2.a,f, 16.3.a)	0	29
<b>M20</b> To see him in a dark room, he or she should illuminate the mirror rather than himself. (14.1.b, 14.2.b,c, 14.3.a)	13	25
<b>AVERAGE</b>	<b>12</b>	<b>19</b>

high school students having each misconception from the study of Kutluay (2005). According to the analysis of data the average misconception percentage for pre-service teachers is 12, whereas the average misconception percentage for high school students is 19 for the same test. 73 percent of the pre-service teachers have the misconception labeled as M12 (an image in a plane mirror lies behind the mirror along the line of sight between a viewer and the object) whereas only 18 percent of the high school students have this misconception. None of the pre-service teachers have the misconception labeled as M4, on the other hand 31 percent of the high school students have the same misconception. Table 2 illustrates the analysis of the GOMT results of pre-service teachers for one tier, two tier and three tiers separately. According to the results, if only first tiers of the test are considered an average of 33 percent of misconceptions present for pre-service teachers, if first two tiers of the test considered an average of 15 percent of misconceptions present, and when all three tiers are considered an average of 12 percent of misconceptions present for pre-service teachers. Comparing the analysis for only first tiers and first two tiers a percentage of 18 is predicted to be due to the errors in answers. Also, comparing the analysis for first two tiers and all three tiers a percentage of three is attributed to the lack of knowledge.

Table 2 *Percentages of the Misconceptions of Pre-service Teachers Considering the Tiers of the GOMT*

	<b>All Three Tiers</b>	<b>First Two Tiers</b>	<b>Only First Tiers</b>
<b>M1</b>	4	7	43
<b>M2</b>	3	7	43
<b>M3</b>	3	3	43
<b>M4</b>	0	0	7
<b>M5</b>	17	17	7
<b>M6</b>	20	20	60
<b>M7</b>	3	7	40
<b>M8</b>	7	10	60
<b>M9</b>	10	13	20
<b>M10</b>	27	27	20
<b>M11</b>	0	3	33
<b>M12</b>	73	80	50
<b>M13</b>	27	43	43
<b>M14</b>	10	17	20
<b>M15</b>	7	10	3
<b>M16</b>	7	7	0
<b>M17</b>	7	7	27
<b>M18</b>	10	10	13
<b>M19</b>	0	0	30
<b>M20</b>	13	13	37
<b>AVERAGE</b>	<b>12</b>	<b>15</b>	<b>33</b>

Similarly Table 3 presents the comparison of misconception categories with percentages for high school students from the study of Turker (2005) and pre-service teachers for the all three tiers of FMMT. The most striking results appear in I4, I5, and AF6 between both samples. According to Table 4, three tier analyses reveal that six percent of the misconceptions are attributed to errors, and three percent is to the lack of knowledge.

Table 5 shows the comparison of misconception categories with percentages for high school students from the study of Pesman (2005) and pre-service teachers for the all three tiers of SECMT, and M3 and M11 seems somehow different for the two samples.

Table 3 Comparison of Misconception Categories for High School Students and Pre-service Teachers for the All Three tiers of FMMT

Misconceptions (Items)	% of Preservice (N=30)	% of High School (N=188)
<b>I1</b> Impetus supplied by hit (7.1 a, 7.2 c, 7.3 a/b), (7.1 b, 7.2 a, 7.3 a/b), (16.1 b, 16.2 b, 16.3 a/b), (16.1 c, 16.2 a, 16.3 a/b)	23	18
<b>I2</b> Loss/ Recovery of original impetus (5.1 c, 5.2 a, 5.3 a/b), (14.1 a, 14.2 c, 14.3 a/b), (14.1 c, 14.2 b, 14.3 a/b)	7	26
<b>I3</b> Impetus dissipation (4.1 a, 4.2 b, 4.3 a/b), (4.1 b, 4.2 c, 4.3 a/b), (6.1 b, 6.2 c, 6.3 a/b)	7	30
<b>I4</b> Gradual/ delayed impetus build- up (6.1. c, 6.2 a, 6.3 a/b), (12.1 c, 12.2 a, 12.3 a/b)	0	33
<b>I5</b> Circular impetus (3.1 a, 3.2 c, 3.3 a/b), (3.1 b, 3.2 c, 3.3a/b)	7	43
<b>AF1</b> Only active agents exert force (2.1 a, 2.2 c, 2.3 a/b), (15.1 a, 15.2 d, 15.3 a/b)	0	4
<b>AF2</b> Motion implies active force (2.1 c, 2.2 a, 2.3 a/b), (2.1 d, 2.2 e, 2.3 a/b), (11.1 b, 11.2 b, 11.3 a/b), (11.1 c, 11.2 a, 11.3 a/b)	27	24
<b>AF4</b> Velocity proportional to applied force (13.1 a, 13.2 b, 13. 3 a/b)	7	13
<b>AF6</b> Force causes acceleration to terminal velocity (13.1 c, 13.2 a, 13.3 a/b)	3	35
<b>AR1</b> Greater mass implies greater force (1.1 a, 1.2 c, 1.3 a/b), (1.1 c, 1.2 b, 1.3 a/b), (8.1 b, 8.2 a, 8.3 a/b), (15.1 b, 15.2 a, 15.3 a/b)	3	29
<b>AR2</b> Most active agent produces greatest force (8.1 c, 8.2 b, 8.3 a/b), (9.1 b, 9.2 d, 9.3 a/b), (15.1 b, 15.2 b, 15.3 a/b)	7	11
<b>CI1</b> Largest force determines motion (8.1 c, 8.2 d, 8.3 a/b), (9.1 b, 9.2 c, 9.3 a/b), (10.1 a, 10.2 b, 10.3 a/b), (10.1 c, 10.2 a, 10.3 a/b)	30	28
<b>CI2</b> Force compromise determines motion (5.1 b, 5.2 d, 5.3 a/b), (12.1 b, 12.2 c, 12.3 a/b)	10	10
<b>CI3</b> Last force to act determines motion (5.1 a, 5.2 b, 5.3 a/b), (12.1 a, 12.2 d, 12.3 a/b)	17	12
<b>CF</b> Centrifugal force (2.1 e, 2.2 b, 2.3 a/b), (3.1 d, 3.2 a, 3.3 a/b), (3.1 e, 3.2 a, 3.3 a/b), (11.1 d, 11.2 c, 11.3 a/b)	7	8
<b>Ob</b> Obstacles exert no force (9.1 c, 9.2 a, 9.3 a/b)	23	17
<b>AVERAGE</b>	<b>11</b>	<b>21</b>

Table 5 Comparison of Misconception Categories for High School Students and Pre-service Teachers for the All Three tiers of SECMT

Misconceptions (Items)	% of Preservice (N=30)	% of High School (N=124)
<b>M1</b> Sink Model (1.1 a, 1.2 a, 1.3 a), (10.1 a, b, 10.2 b, 10.3 a)	3	5
<b>M2</b> Attenuation Model (4.1b, c, 4.2 c, 4.3 a)	0	4
<b>M3</b> Sharing Current Model (3.1 b, 3.2 c, 3.3.a), (3.1 a, 3.2 c, 3.3.a), (4.1 d, 4.2 c, 4.3 a), (5.1 a, b, 5.2 c, 5.3 a)	0	11
<b>M4</b> Clashing Current Model (1.1 b, 1.2 b, 1.3 a), (10.1 a, 10.2 a, 10.3 a)	10	26
<b>M5</b> Empirical Rule Model (4.1 b, 4.2 a, 4.3 a), (7.1 b, 7.2 b, 7.3 a), (12.1.a, 12.2.b, 12.3 a)	0	4
<b>M6</b> Short Circuit Misconception (8.1 b, 8.2 b, 8.3 a), (8.1 c, 8.2 c, 8.3 a), (10.1 a, 10.2 c, 10.3 a), (12.1 b, 12.2 d, 12.3 a)	17	16
<b>M7</b> Power Supply as a Constant Current Source Model (3.1a, c, 3.2 a, 3.3 a), (5.1 c, 5.2 e, 5.3 a), (9.1 d, 9.1 d, 9.3 a)	7	9
<b>M8</b> Parallel Circuit Misconception (5.1 a, 5.2 a, 5.3 a)	0	2
<b>M9</b> Sequential Reasoning (9.1 a, 9.2 a, 9.3 a), (9.1 c, 9.2 b, 9.3 a)	0	4
<b>M10</b> Local Reasoning (2.1 a, 2.2 a, 2.3 a), (5.1 a, 5.2 b, 5.3 a), (12.1 a, 12.2 c, 12.3 a)	10	15
<b>M11</b> Confusion Between Current Flow and Water Flow (6.1 a, 6.2 a, 6.3 a), (7.1 c, 7.2 a, 7.3 a), (11.1 a, 11.2 b, 11.3 a)	0	8
<b>AVERAGE</b>	<b>4</b>	<b>9</b>

Table 4 *Proportions of the Misconceptions of Pre-service Teachers Considering the Tiers of the FMMT*

<b>Misconceptions</b>	<b>All Three Tiers</b>	<b>First Two Tiers</b>	<b>Only First Tiers</b>
I1	23	23	40
I2	7	17	30
I3	7	10	23
I4	0	0	10
I5	7	10	20
AF1	0	0	0
AF2	27	30	33
AF4	7	13	13
AF6	3	7	7
AR1	3	3	13
AR2	7	7	30
CI1	30	37	17
CI2	10	20	13
CI3	17	17	17
CF	7	10	23
Ob	23	23	23
<b>AVERAGE</b>	<b>11</b>	<b>14</b>	<b>20</b>

According to Table 6, three tier analyses reveal that one percent of the misconceptions are attributed to errors, and one percent to the lack of knowledge.

Table 6 *Proportions of the Misconceptions of Pre-service Teachers Considering the Tiers of the SECMT*

<b>Misconceptions</b>	<b>All Three Tiers</b>	<b>First Two Tiers</b>	<b>Only First Tiers</b>
M1	3	3	30
M2	0	0	0
M3	0	0	0
M4	10	10	0
M5	0	0	0
M6	17	23	7
M7	7	7	10
M8	0	0	0
M9	0	0	0
M10	10	13	13
M11	0	0	3
<b>AVERAGE</b>	<b>4</b>	<b>5</b>	<b>6</b>

### **Conclusion and Discussion**

Identification of pure misconceptions eliminated from errors and lack of knowledge is crucial. Present study provides the literature with valuable information in two folds: firstly the difference between one, two, tier analysis of three different concepts, secondly the comparison of the misconception categories identified with these three concepts for pre-service teachers and the high school students. The results show that analysis of misconceptions with three tier tests eliminates the overestimation of one and two tier tests and disadvantages of the other methods. Also results show that pre-service teachers even after formal education have misconceptions on the three topics like high school students. For this reason teachers should be considered as a source of their students' misconceptions and a special attention should be given to teacher education process.

# HOW PRE-SERVICE PHYSICS TEACHERS INTERPRET STATIC AND KINETIC FRICTION: A LABORATORY EXPERIMENT

Ozlem Oktay<sup>1,\*</sup> and Derya Kaltakci<sup>2,\*\*</sup>

<sup>1</sup> Department of Secondary Science/Math. Education, Middle East Technical University, Ankara, Turkey, [ozoktay@metu.edu.tr](mailto:ozoktay@metu.edu.tr)

<sup>2</sup> Department of Secondary Science/Math. Education, , Middle East Technical University, Ankara, Turkey, [kaderya@metu.edu.tr](mailto:kaderya@metu.edu.tr)

## Abstract

The aim of this study is to explore pre-service physics teachers' conceptual understanding and their reasoning underlying a physics topic. Friction was chosen as a concept. Data were collected in an elective laboratory course designed for ten pre-service physics teachers at Middle East Technical University (METU) in Turkey. At the beginning of the laboratory course, a brief pre-test was given to the pre-service physics teachers. The purpose of the pre-test was to search their preconceptions about the friction forces (static and kinetic), net force and applied force, acceleration and Newton's second law of motion. For this experiment, a worksheet was prepared by modifying the related topic from Physics by Inquiry (McDermott, 1996). The entire process was video recorded for data analysis. In addition, pre-service physics teachers' written works on the experiment were used for analyzing their conceptions on the topic. At the end of the work, a feedback questionnaire was given to investigate pre-service physics teachers' attitudes towards the experiments. Qualitative analysis of data showed that pre-service physics teachers, even though they are capable of using equations related to static and kinetic friction, are lack of conceptual understanding on the topic. Also, they had positive attitude toward the instructional process.

## Introduction

Physics education research has been emphasized on students' difficulties and misconceptions (Hammer, 2000). If they do not have any clear and informed conceptions about some topics, they cannot construct their own learning and meaningful understanding. In this study, concept of friction was chosen as a laboratory activity. Because, most of the time this concept is experienced in our daily lives. It is given as a concept in high school curricula and introductory physics university courses. Also, it is covered under the heading of "Force and Motion". Although, most of the tasks required the basic mathematical formulas can be solved related to this concept, students have inadequate understandings and applications problems in connection with Newton's law of motion. In addition, we chose this topic if students think that this topic is useful and mostly related to the real life experiences, they can improve their motivation and effort to their lesson (Barlia & Beeth, 1999; Pintrich & Schunk, 1996). Our aim is to give critical reflection taking into account pre-service physics teachers' understandings and attitudes and to investigate common student difficulties and problems about this concept.

---

\* On behalf of Department of Secondary Science/Math. Education, Ataturk University, Erzurum, Turkey

\*\*On behalf of Department of Secondary Science/Math. Education, Kocaeli University, Kocaeli, Turkey

These research questions were investigated;

- (1) What are the common misconceptions and difficulties related to the force of friction?
- (2) How do pre-service physics' teachers explain the force of friction and factors that affected to this concept?
- (3) How do pre-service physics' teachers explain the Newton's second law of motion considering the force of friction?
- (4) What are pre-service physics teachers' opinions about the topic and the laboratory activity?

### **Related Literature**

Researchers from different theoretical perspectives argued that the most important things that students' bring to their classes are their concepts (Griffiths & Preston, 1992). For this reason studies on students' conceptions and misconceptions along with their reasoning are of particular interest to educators and researchers in that field. Studies in students' conceptions and reasoning about the force concept (Clement, 1982; Halloun & Hestenes, 1985) have been studied widely in physics education. In the scope of the force, friction is a concept that needs some further investigation.

Some studies have been investigated students' specific difficulties with friction (Krim, 2002; Besson, 2004). Generally, in these researches as a misunderstanding, students do not think that friction forces as a motive role as well as a resistive. Another research conducted by Viennot (2002) proposed a short teaching sequence based on different models. She examined students' common concepts becoming guidance in the modeling process by designing lessons. Another research is conducted by Corpuz and Rebello (2006) studied microscopic friction by investigating university students' mental models.

Based on the literature review, it seems that the friction concept has a key role to investigate on different situations. In main mechanics concepts such as force, friction is needed to be conceptualized by students.

### **Methodology**

In this study, qualitative research methodology was used to gain an insight about the phenomena.

### **Sampling and Fieldwork**

The participants of the study were ten pre-service physics teachers at Middle East Technical University (METU) who take Laboratory Experiments in Physics Teaching course. Study was conducted with a total of five groups. In this study, as a teaching method inquiry process was used. The inquiry process was used in order to examine pre-service physics teachers' reasoning and improve the pre-service physics teachers' conceptual understanding by generating discussion environment in the laboratory. During the laboratory work, the pre-service physics teachers were required to evaluate the whole experimental process and interpret their findings. During the whole process two researchers were included into the course. Their role was guiding the inquiry process and collecting data.

### **Data Collection**

Video records, individual interviews, written works, a brief pre-test and feedback questionnaire were used in order to get deep information about conceptions and reasoning about the concept.

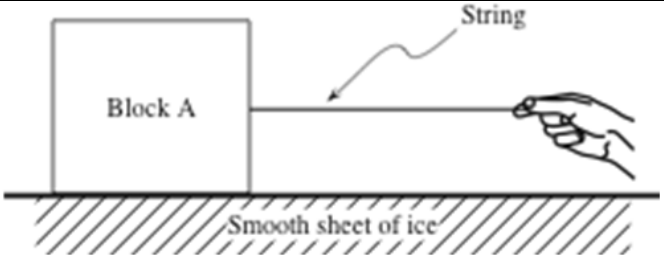
At the beginning of the laboratory course, a pre-test was given to the pre-service physics teachers so as to search their preconceptions about the friction forces (static and kinetic), net force and applied force, acceleration and Newton's second law of motion. It included one question composed with four parts. For this experiment, a worksheet was used by modifying the related topic from Physics by Inquiry (McDermott, 1996). It consisted of two parts. In part one, we asked pre service physics teachers to examine static and kinetic friction force for different types of sliding surfaces, different masses and different sides of the same object. They analyzed the factors which affect the friction force and distinguish static and kinetic friction forces. We asked pre-service teachers' to write reasons and explain each situation. In the second part, the participants performed a basic Newton's second law of motion experiment in which they observed the motion, took data, plotted graphs and interpreted them considering the friction forces. Researchers were conducted twenty-minutes of semi-structured individual interviews with participants at the end of the course. It provided a validation of written works. In addition, pre-service physics teachers' written works on the experiment were used for analyzing their conceptions on the topic. At the end of the work, feedback likert type questionnaire was given to investigate their attitudes towards the experiments. It included ten statements from strongly disagree to strongly agree as well as an open ended item for any suggestions and opinions about the experiments.

## Findings

### Pretest

In the pretest pre-service physics teachers were asked a three-level question that was revised from Physics by Inquiry (McDermott, 1996). The pretest question is given in Figure 1. For the question, only four of the ten participants draw a qualitative graph with considering the friction force and starting the graphs from a nonzero applied force by the spring in zero acceleration. Also there are different reasoning for the slopes and acceleration of the block on wood and ice surfaces. Table 1 illustrates some examples for the participants' answer.

Block A is initially at rest on a smooth, level sheet of ice, as shown. A string exerts a constant force on the block from  $t = 0$  s to  $t = T$  s, after which the string is cut. Block A has moved a distance  $d$  when the string is cut.



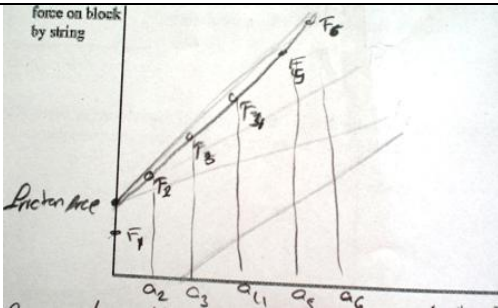
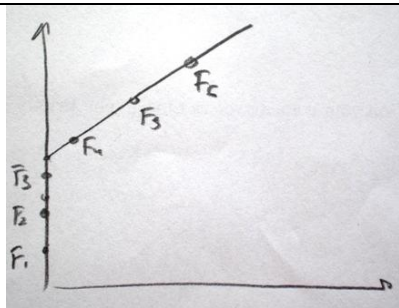
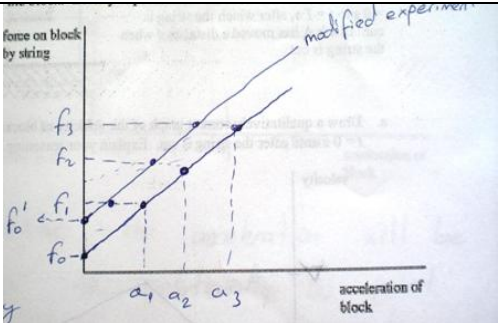
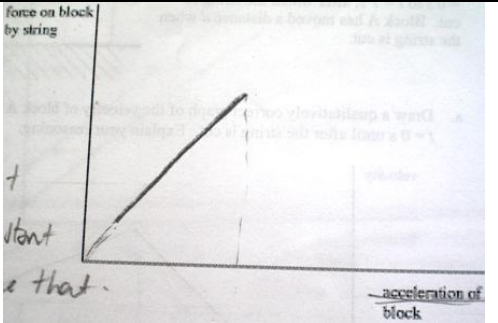
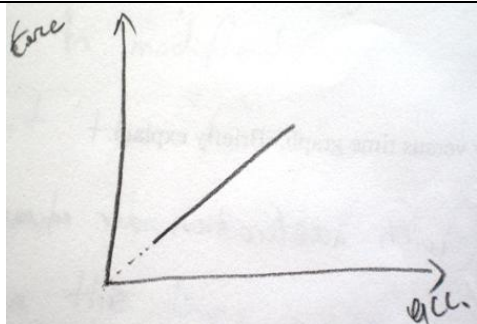
The diagram shows a rectangular block labeled 'Block A' on a horizontal surface labeled 'Smooth sheet of ice'. A string is attached to the right side of the block and extends to the right, where it is held by a hand. An arrow labeled 'String' points to the string.

- Draw a qualitatively correct graph of the velocity of block A versus time. Include times from  $t = 0$  s until after the string is cut. Explain your reasoning.
- Suppose the experiment described on the previous page were repeated using several different *constant* forces. Draw a qualitatively correct graph of the *force exerted on the block by the string* versus the *acceleration of the block*. Briefly explain.
- Suppose the experiments described in part b were repeated on a smooth, level *wood* surface. How, if at all, would a plot of the force exerted on the block by the string versus the acceleration of the block differ from your graph from part b? Explain your reasoning, and, on your axes from part b, sketch a qualitatively correct graph for the modified experiments on the wood surface.

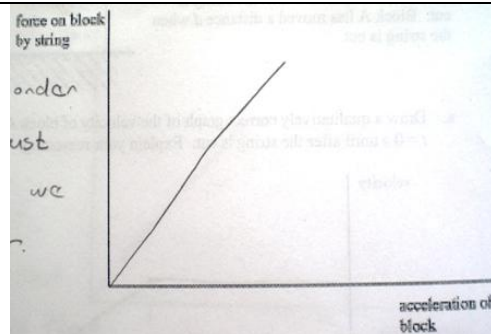
Figure 1. Pretest Question for the Study



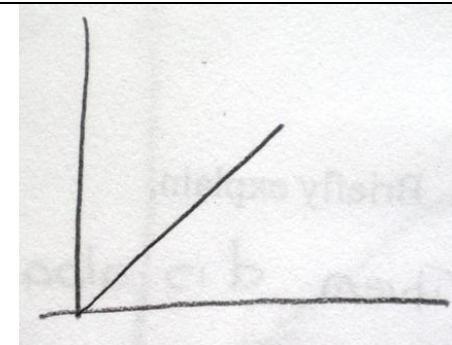
Table 1. Examples to Student Responses for Pretest Question

	Icy surface	Wood surface
<b>Student 1</b>	<p>If applied force is more than friction force block gains a constant acceleration and if we increase force, acceleration increases too.</p> 	<p>The starting force will increase and the slope of line will decrease since friction is greater (<math>a_{\text{wood}} &lt; a_{\text{ice}}</math>).</p> 
<b>Student 2</b>	<p>Acceleration increases with the increasing force. The graph starts from <math>f_0</math> since there is a small friction and no acceleration until the force exceeds the friction.</p> 	<p>Friction will be greater <math>f_0</math> and the acceleration for the same force will be lower. The lines on the graph must be parallel, since due to friction there will be no force relates with same acceleration for both graph, it will never intercepts.</p>
<b>Student 3</b>	<p><math>F/a=m</math>, since the tangent of the graph, mass, will be constant the graph should be linear.</p> 	<p>The graph does not change, since the slope of the plot yields the mass of the block, which is same for the two cases.</p> 

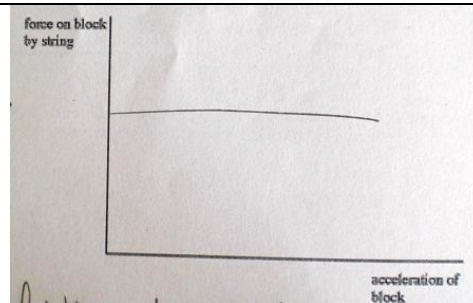
**Student 4** Acceleration increases as the force increases.



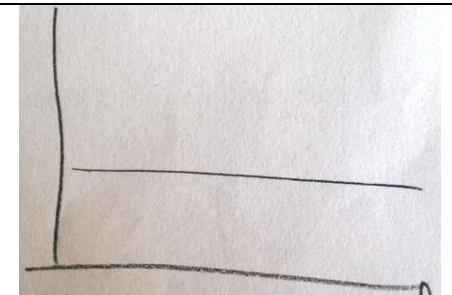
On wood surface acceleration decreases. But  $F$  is also decrease. So the plot of the graph does not change.



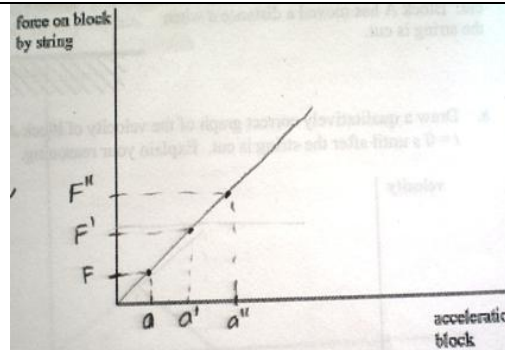
**Student 5** If force exceeds friction it accelerates constantly, otherwise it won't accelerate and stay at rest.



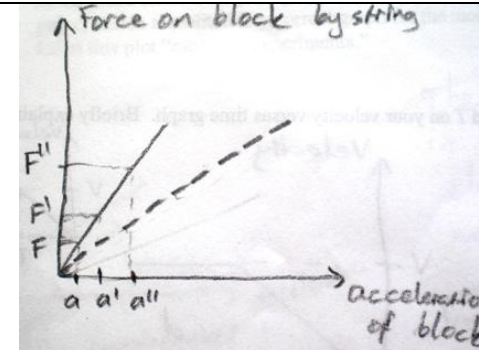
If force exceeds friction it accelerates constantly, otherwise it won't accelerate and stay at rest.



**Student 6** For different constant forces we obtain different accelerations.



In this case there is bigger friction, so line will shift to left. It means with same applied force, we obtain smaller acceleration.

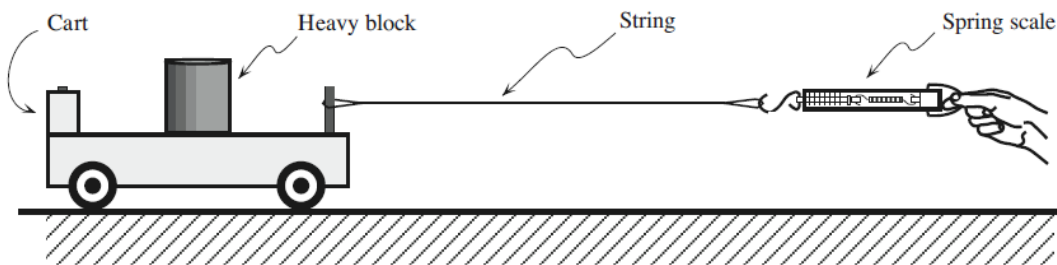


## Written Work and Individual Interviews

This part included two parts. We prepared this worksheet revising from Physics by Inquiry (McDermott, 1996). We were considered to point out static and kinetic friction force and some factors that affect the friction. Teacher candidates tried some procedures by using different type of surfaces (glass, Styrofoam, marble, cardboard, carpet, etc.), different masses of blocks and different sides of same objects.

When we look at the individual interviews and video records, they were familiar with basic concepts about the friction force, the difference between static and kinetic friction, and factors that needs to be investigated in the worksheet. But, they experienced some confusion about their results of the surface area of the same object which is in contact with the surface. They did not much more reliable and dependable results in this section. All of the students' prior ideas and all information in the written books explain surface area of contact of sliding surfaces has no influence on friction. When pre-service teachers had this trouble with what they know before, they tried to explain by changing different conditions as if they are a teacher. Firstly, they did not notice to consider at microscopic level and surface phenomena. Later in the interview part with the probing questions, they discussed the nature of materials in contact and their surface coatings can be different, and can cause differences friction force. In the second part, a question was asked as indicated in Figure 2. With this question, we investigated how they interpret  $F_{\text{applied}}$ ,  $F_{\text{net}}$  forces, friction force, starting point of the line, the value of x and y intercept on their graph. Table 2 illustrates some examples and participants' answer.

Obtain a cart, a heavy block, and a dynamometer from. Locate a smooth surface, approximately four meters long, on which you can roll the cart. Mark starting and finishing lines three meters apart on the surface. Place the heavy block on the cart. We will refer to the cart plus the heavy block as the "cart system." Attach the dynamometer to the cart system using about 1 m of string.



**A.** Practice pulling the cart system, initially at rest, between the starting and finishing lines using the dynamometer to exert a constant force throughout the motion.

**B.** Select a particular constant force and record the time that it takes for the cart system, starting from rest, to travel three meters. Repeat this measurement at least four times and average your results. Calculate the acceleration of the cart system.

Figure 2. Main question in Part 2

According to results, all of the pre-service physics' teachers indicated that Newton's second law which is the acceleration of an object is directly proportional to the resultant force acting on it and inversely proportional to its mass. But, out of ten participants as seen above had some problems related to pulling force and resultant force. They were not aware of the friction force when drawing their prediction graph in this situation. The other five of the participants stated that  $F$  is proportional  $a$ , but graph do not start from zero point, because of the friction force. After giving the prepared data, they asked to draw plot of graph  $F$  versus  $a$ . Then they compared their predicted graph to the plotted from the data. Then they discussed the value of  $x$  and  $y$  intercepts, since none of the participants mentioned it in their worksheets in detail. An example is given above.

*I: What is the value of the y-intercept ( $x=0$ ), what do you think?*

*S: Hmm,*

*I: Think about the acceleration in this point.*

*S:  $a=0$ . So according to Newton's first law, if an object at rest it will remain at rest or if an object in motion, will continue in motion with a constant velocity.*

*I: So at that point which condition can be appropriate according to Newton's first law?*

*S: We pulled this card system with a constant force, so it cannot be at rest at this point. It might be in motion.*

*I: Now we said that at this point acceleration is zero, what about the time? Is it zero?*

*S: No, time cannot be zero at this point. It can be any time. So before and after that point the object is in motion, at that time it has zero acceleration. This point must be the place where card system is moving with constant velocity.*

*I: What about the force at that point?*

*S:  $F_{net}$  is zero. Pulling force should equal to friction force.*

*I: Is this static or kinetic friction?*

*S: I think it is a kinetic friction force, because we said there is a motion. So this can be kinetic friction.*

*I: Ok. Let's think about the x-intercept. Before this, if you extent the line, you see that it does not intersect at  $(0,0)$  point.*

*S: We learned that it was friction force so, line do not intersect at  $(0, 0)$  point.*

*I: Ok. What about the value of x-intercept?*

*S: This value is negative. Yes, line passed from a value at negative x-axis. It shows a negative acceleration in the opposite direction force.*

*I: Good. How can you describe this motion of the cart?*

*S: Hmm, good question. Pulling cart has a positive acceleration before, and then the rope might be broken and it decelerates.*

## **Feedback Questionnaire**

The results of the feedback questionnaire showed that pre-service physics teachers' had a positive attitude toward the instructional process. According to the results of the questionnaire, pre-service physics teachers found the topic in the instructional material interesting and at an appropriate level. They also claimed that the experiments helped them to come up with ideas that they had never thought before. Some pre-service teachers stated that the x-intercept in  $F$  versus  $a$  graph is a challenging and thought-provoking part of the activity that they never thought before.

## **Conclusion and Discussion**

As indicated before, our purpose was to investigate pre-service physics teachers' conceptual understanding and their reasoning skills on friction concept that is one of the important topics of physics. With the inquiry process integrated into laboratory experiment showed that pre-service physics' teachers although they explain and know the basic concept about the friction, sometimes they had some difficulties. For example, most of them did not interpret the graphs of applied force versus acceleration and net force versus acceleration. They had different reasoning about the starting point of the graphs and the value of x and y intercepts. On the other hand, all of them explained the difference between the kinetic and static friction, and factors affecting friction. Sometimes, they took some unreliable numerical results. As a reason, they ignored to take data at least three times. They did not notice to consider at microscopic level and surface phenomena. During the challenging questions in the inquiry process, they discussed the nature of materials in contact and their surface coatings can be different, and can cause differences friction force. Another point in this study, pre-service physics teachers' had a positive attitude toward the instructional process. They also claimed that the experiments in the worksheet challenged them to re-think critically. We can say that pre-service physics' teachers were not familiar inquiry as a method in the learning and teaching. Prepared worksheets and appropriate guidance by instructors helped them to think more critically and explore their reasoning. Therefore, the findings of this study could help instructors in order to use kinds of approaches and student- centered activities when teaching the concepts in physics.

## References

- Barlia, L., & Beeth M. E. (1999). *High School Students' Motivation to Engage in Conceptual Change Learning in Science*. Annual Meeting of the National Association for Research in Science Teaching, Boston, MA, National Association for Research in Science Teaching.
- Besson, U. (2004). Some features of causal reasoning: Common sense and physics teaching. *Research in Science and Technological Education*, 22(1), 113–125.
- Clement, J. (1982). Students' preconceptions in introductory physics. *American Journal of Physics*, 50, 66-71.
- Corpuz, E. G., & Rebello, N. S. (2006). *Students' conceptual development in the context of microscopic friction: A case study with two students*. Paper presented at the Proceedings of the NARST 2006 Annual Meeting, San Francisco. Retrieved August 1 from [http://web.phys.ksu.edu/papers/2006/Corpuz\\_NARST2006.pdf](http://web.phys.ksu.edu/papers/2006/Corpuz_NARST2006.pdf).
- Griffiths, A. K., & Preston, K. R. (1992). Grade-12 Students' Misconceptions Relating to Fundamental Characteristics of Atoms and Molecules. *Journal of Research in Science Teaching*, 29(6), 611-628.
- Halloun, I., & Hestenes, D. (1985). Initial knowledge state of college physics students. *American Journal of Physics*, 53(11), 1043-1055.
- Hammer, D. (2000). Student resources for learning introductory physics. *American Journal of Physics, Physics Education Research Supplement*, 68 (7), 52-59.
- Krim, J. (2002). Resources letter: Friction at macroscopic and microscopic length scale. *American Journal of Physics*, 70, 890–897.
- McDermott, L. C. (1996). *Physics by Inquiry*. USA: John Wiley & Sons, Inc.
- Viennot, L. (2002). *Teaching physics*. Dordrecht: Kluwer, 2003.
- Pintrich, P. R. and D. Schunk (1996). *Motivation in Education: Theory, Research and Application*. Columbus, OH, Merrill Prentice-Hall.

## **TPACK - a Prerequisite for Successful Technology Integration into the Classroom?**

Hildegard Urban-Woldron, Martin Hopf

### **ABSTRACT**

Increasingly available technological resources to teachers and school children are assumed to contribute to innovative practice and learning across subject areas. Simultaneously, a growing number of studies are discovering that both new and experienced teachers feel inadequately prepared to use computers and other forms of technology in their classrooms. All too often technology is probably being used in ways that replicate traditional instructional strategies and learning and does not allow students to engage in learning with technology. Therefore, to meet the needs, it has to be better understood how to best support and promote technology integration among subject-matter teachers in both informal and formal learning contexts.

The impetus for this study was given by research findings in the area of educational technology and finally by previous work, in particular by outcomes of a comparative analysis of Austrian eLearning projects which showed that the main focus of the teachers using technology in the classroom was on technological issues. Therefore the purpose of this study was to investigate the influence of an educational technology teacher course based on the Technological Pedagogical Content Knowledge (TPACK) - Framework on the learning outcomes of the students.

Nine Physics teachers who volunteered for using TI technology in combination with a motion detector used these tools in the classroom in grades 6, 9 and 10 (total of 14 classes and 299 students) to teach mechanics/kinematics. While the same support (courses, accompanying materials, individual tuition) was offered to all nine teachers, not all of them participated to the same extent.

Participation in Teacher Training had a significant impact on students' perception of the learning environment and finally on the quality of learning motivation and cognitive learning activities.

### **KEYWORDS**

TPACK, Professional Teacher Development, Technology Integration, Teacher Training, Kinematics Graphs,

### **INTRODUCTION**

Key findings from a review of studies of ICT impact on schools in Europe show that teachers do not yet exploit the creative potential of ICT and do not engage students more actively in the production of knowledge (Balanskat et al., 2006). Teacher training should not just encompass ICT skills but rather a full understanding and complete mastery of ICT as pedagogical tools (Punie et al., 2006). The thoughtful pedagogical uses of technology require the development of a complex, situated form of knowledge that Koehler & Mishra (2005) call TPACK (Technological Pedagogical Content Knowledge).

An essential question concerning these issues lies in (1) how teachers can learn to infuse technology innovatively into subject area instruction and learning and (2) how to help teachers to make individual meaning of new constructs and experiences with technology to determine its impact on education, including learning processes, access to content, and instructional methods (Hughes, 2005). One of the most important things to understand about technologies is



that particular technologies have both specific properties that allow certain actions to be performed encouraging specific types of learner behaviour and also constraints (Koehler & Mishra, 2008). Integration of technology into the classroom requires deep understanding of complicated interactions of multiple factors (Koehler, Mishra & Yahaya, 2007). The teacher is viewed as an autonomous agent with the power to significantly influence the appropriate (or inappropriate) integration of technology in teaching.

Results of a review carried out on behalf of the IMST Fund (<http://imst.uni-klu.ac.at>) aiming to identify, analyze and document outstanding examples, considered to be “best practice”, to augment the knowledge base of exemplary teaching practice with new media out of 81 evaluation reports of Austrian math and science teachers, showed that many teachers mainly focused on technological issues and scarcely kept an eye on connecting subject matter content and pedagogical processes in ways that promote effective student learning in the content area by using technology (Urban-Woldron, 2008). Therefore, research is needed to identify avenues how to support professional development for teachers in their process of learning to effectively integrate technology into classroom practice at multiple levels; theoretically, pedagogically and methodologically.

The present study is based on the findings of extensive research in the field of technology integration and learning motivation and explores the relationships between teacher participation in a training course and student outcomes concerning their learning motivation and learning activities. The main focus of the study lies on the investigation of the relationship between teacher training and learning motivation within a technology enriched learning environment.

## CONCEPTUAL FRAMEWORK

### *Integrating content, pedagogy and technology*

Technological pedagogical content knowledge (TPACK), formerly known as TPC K) is a conceptual framework designed to illustrate the multifaceted interplay and characteristics of teacher knowledge and technology integration in education. By extending Shulman’s concept of pedagogical content knowledge Koehler and Mishra built this framework, which highlights complex relationships that exist between content, pedagogy and technology knowledge areas (see fig. 1). According to Archambault and Crippen (2009) the TPACK framework may be a useful organizational structure for defining what it is that teachers need to know to integrate technology effectively.

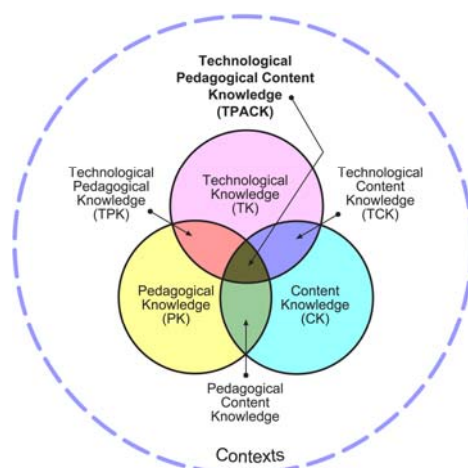




Figure 1. TPACK framework for teacher knowledge<sup>1</sup>

TPACK is at the intersection of all three elements of teacher knowledge. Effective technology integration for pedagogy around specific subject matter requires developing sensitivity to the dynamic, transactional relationship between these three components bringing together the teaching of subject matter with effective and appropriate uses of technology and refining teaching practices to engage students in the use of technology as they investigate curriculum, express what they know and understand, and apply knowledge to construct new meaning.

#### ***Entry – Adopt – Adapt – Appropriate – Invent***

According to the conceptual framework of Sandholtz, Ringstaff & Dwyer (1997) teachers have to move through an evolution of thought and practice (ETP) when learning to use technology in the learning process. They start in the so-called entry-phase and end up in the invention-phase discovering new uses for technology tools and using technology as a flexible tool in the classroom facilitating the emergence of new teaching and learning practices.

#### ***Content Pedagogical Issues***

The learning activities used in the study were inspired by publications uncovering a consistent set of student difficulties with graphs of position, velocity and acceleration versus time. Research indicates that the use of a Motion Detector is effective, particularly in the area of graphical interpretation (Thornton & Sokoloff, 1990). For developing the conceptual understanding and reasoning skills necessary to teach science as a process of inquiry, materials developed by McDermott were used after adapting them to the particular student age (McDermott, 1996).

#### **RESEARCH QUESTIONS**

Specifically, the following two research questions were raised:

- (1) Does the student perception of the learning environment depend on the degree of participation of the associated teacher in the teacher training course?
- (2) Does the engagement of the teacher in the teacher training course influence the quality of student learning motivation and learning activities?

#### **METHODS AND SAMPLES**

##### ***Designing and conducting a teacher training course***

Based on the conceptual frameworks of TPACK and ETP a blended learning course for teacher training, including a half-day session, was designed and offered to nine teachers carrying out eLearning-projects granted by the IMST Fund. It started with a face-to-face session which was attended by all nine teachers being novices in using motion detectors. Over the next ten months the teachers were supported by an electronic platform, where they were expected to discuss their lesson plans and collectively reflect on their teaching activities and how to become more learner centered when implementing technology in teaching kinematics.

In the face-to-face teacher training session, as a starting point, according to the first two phases of ETP, the teachers were primarily introduced to the use of motion sensors used along with graphing calculators by trainer demonstration. Addressing phases three to five from ETP teachers are next introduced the special feature of the application EASYDATA of the TI84 Plus which supports the activity “Distance vs. Time Graphing” by generating random target distance graphs consisting of three linear parts (see Fig. 2).

<sup>1</sup> Source: <http://tpack.org/tpck/images/tpck/a/1/TPack-contexts.jpg>

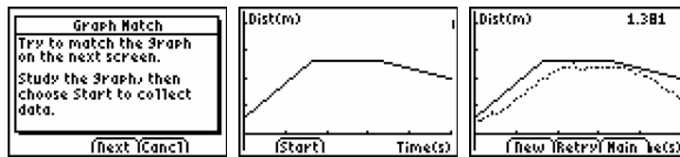


Figure 2. Distance vs. Time Graph (to match)

The students have to study the graphs and write down how they would walk to produce the target graph shown on the screen. Teachers were invited to consider what specific teaching and learning goals within the context of kinematics could be addressed by this particular feature and to discuss how it could be implemented. At the end of the face-to-face session the teachers were motivated to continue participating in the course by using the electronic platform to pose questions, stay in touch, discuss and exchange ideas and to reflect collaboratively on lesson plans and teaching experiences.

Whereas four teachers actively used the Elearning platform by asking questions, encouraging colleagues in discussions, exchanging materials and lesson plans as well as refining and reflecting ideas, four other teachers did not visit the platform at least once. One teacher took part in some discussions, but did not contribute ideas or materials or posed questions.

#### ***Developing and administering the student questionnaire***

Learning motivation is supposed to be a relevant concept for self-controlled learning in a computer supported learning environment. In the study the quality of the learning environment is measured by the quality of learning motivation and learning activities reported by the students. As a theoretical framework for developing the student questionnaire the self-determination theory and the theory of interest (Deci & Ryan, 2002; Krapp, 2002; Prenzel, 1996) was used. It is assumed that the quality of learning motivation and cognitive learning activities is significantly associated with perceived support of autonomy and competence as well as with the stimulation of activity.

The items for assessing learning motivation and learning activities were primarily drawn from literature (e.g. Prenzel, 2001) and accordingly adapted; the items concerning the impact of educational technology were developed building on findings of the relevant research literature. Some Descriptions for the measures and their Cronbach's alpha internal consistencies derived from the present sample are provided in [Table 21](#).

Scale	Number of items	Cronbach's $\alpha$	Sample item
Quality of learning motivation	10	0.874	"I liked the assignments, because they stimulated me and aroused my curiosity"
Quality of cognitive learning activities	9	0,907	"The assignments provoked me to activate my prior knowledge"
SA	8	0.838	"The assignments inspired me to ask questions and investigate them on my own."
EC	7	0.865	"The assignments enabled working independently."
EA	7	0.807	"I mostly could work on my own pace".

Table 21. Description of measures

A sample of 299 students out of 14 classes provided complete data, which were used for analysis. The students were from grade 6 to 10 and had a mean age of 14,1 years. 165 students were male, 143 were female; 51,5% of the students had German as their mother tongue; 34,5% of the students attended a middle school, 31,1% a secondary lower and 25,4% a secondary

upper school and 9% a vocational school. The students were educated by the nine physics teachers who participated at least in the face-to-face starting session of the blended learning teacher training course described above.

The online questionnaires were completed under the supervision of the responsible teacher. The items were aligned on a Likert scale, ranging from 0, "I totally disagree" to 4, "I totally agree". Besides descriptive statistics structural equation modelling was used to test the relations between the perceived technology-enriched learning environment and the quality of learning and learning activities. The dependence of student outcomes to participating in teacher training was modelled by means of a dummy variable.

## RESULTS

A cluster analysis of the three learning environment variables (*Enhancement of autonomy, stimulation of activity* and *experiencing competence*) shows that only 16% of the learners (CL3) value the support of autonomy and competence as well as the stimulation of a ctivity considerably underneath the mean (see Table 42). On the other hand, about 29% (CL1) report that they feel large enhancement of autonomy and stimulation of activity and that they experience competence to a very high extent. The majority of students (n = 164) can be assigned to cluster 2 (CL2). They can be described as students with perceptions of the learning environment slightly above the mean.

	M <sub>CL1</sub>	SD <sub>CL1</sub>	M <sub>CL2</sub>	SD <sub>CL2</sub>	M <sub>CL3</sub>	SD <sub>CL3</sub>
Enhancement of Autonomy (EA)	3.56	0.28	2.69	0.36	2.05	0.43
Stimulation of Activity (SA)	3.53	0.32	2.76	0.32	1.85	0.43
Experiencing Competence (EC)	3.59	0.32	2.70	0.35	1.79	0.40
Number of students	87		164		48	

Table 42. Descriptive statistics of perceived learning environment

Taking a closer look to the results and looking at the student distribution due to the belonging to a certain class, it can be identified, that the percentages differ very strongly. For example, in class 5 there are no students, who belong to CL3 and in the classes 4, 8 and 10 only one student can be assigned to CL1 (see Fig. 53).

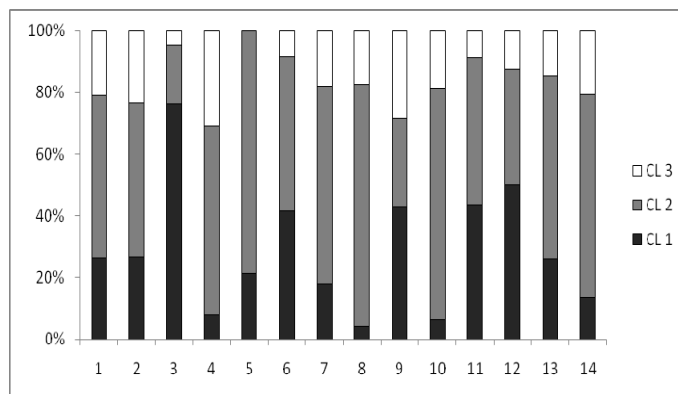


Figure 53. Affiliation to a cluster depending on class

Relating these results to the participation of the respective teacher, it can be stated that there is a significant relationship between student perception of experiencing competence and the extent of participation of the associated teacher in the teacher training course (see Fig. 64).

Teachers who extensively engaged in the online teacher training were labeled with TT = 1, teachers who only attended the exclusive face-to-face meeting were labeled with TT = 0. From this it follows that 127 students, whose teacher was engaged in teacher training, valued the learning environment significantly higher than their peers in the classes with a teacher belonging to the group TT = 0 (see Fig. 64).

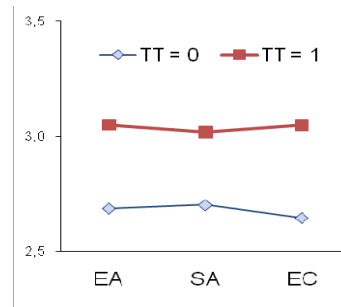


Figure 64.- Perception of learning environment depending on TT

The central aim of this analysis is to draw conclusions about how the basic needs EA and EC along with SA can additionally explain self-determined learning motivation and quality of learning activities and how the results can be related to the TPACK of the teacher. Previous results have identified a relationship between how the students value the learning environment and how well the teacher is trained. For answering the second research question, a path model with two exogenous latent variables (stimulation of activity, participation in teacher training) and two endogenous latent variables (quality of learning motivation / QLM, quality of cognitive learning activities / QLA) and two further latent variables (support of autonomy, experiencing competence), in the sense of mediating variables (see Fig. 75), is introduced. The model reaches a good fit index ( $\chi^2 = 2.682$ ,  $DF = 4$ ,  $p = 0.612$ ,  $\chi^2/DF = 2.45$ ,  $CFI = 1.000$ ,  $RMSEA = 0.000$ ,  $PCLOSE = 0.848$ ) and illustrates that overall 56% of the QLM and 48% of QLA can be explained. Thus the perceived support of autonomy and competence as well as the stimulation of activity in the learning environment present a significant predictor for self-determined learning motivation and consequential learning activities. This means that students who perceive themselves supported in the computer supported learning environment show a higher degree of self-determined learning motivation and more significant learning activities. Participation in teacher training significantly effects support of autonomy and quality of learning motivation and has indirect effects on experiencing competence and the quality of higher cognitive learning activities.

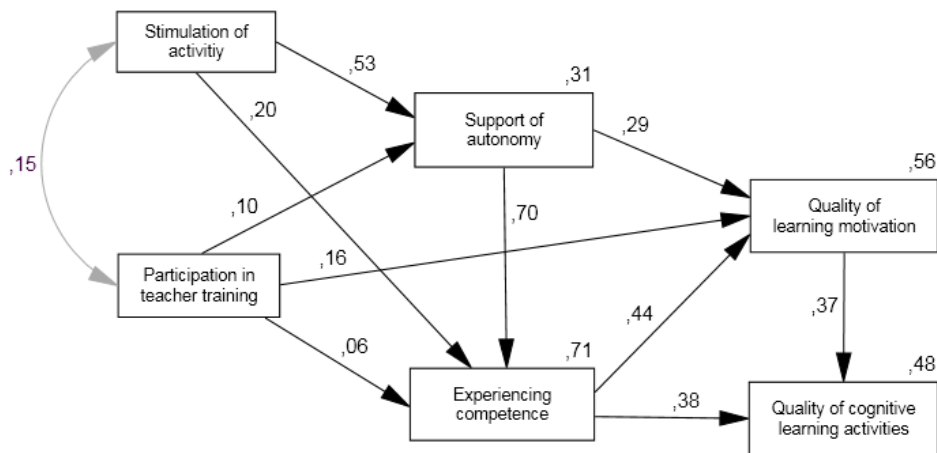


Figure 7. Path model with participation in teacher training, perception of learning environment and quality of learning motivation and learning activities

## DISCUSSION AND CONCLUSIONS

Although the findings of the present study relied on data yielded from self-report surveys of students and associated teachers, probably a few important implications for both research and practice can be derived. First, taking a look at students' outcomes and teachers' responses, it appears that it might be reasonable to teach technology in contents that honour the rich connections between subject-matter (content), technology and the means of teaching it (the pedagogy). Second, it can be assumed that long lasting blended learning teacher courses, in contrast to singular face-to-face meetings, can be an effective means fostering development from viewing technology integration through a simple skill-based lens to effectively integrate it into physics content. Third, in spite of the influence of personality student variables on learning motivation, it seems likely that TPACK of the teacher is a significant predictor how students perceive the technology-enriched learning environment and how technology can help redress some of the misconceptions students have in a particular area.

Further research should (1) focus on different personal variables as predictors for learning motivation and learning activities, (2) employ triangulated methods to examine the changes in in-service teachers' instructional practices and their impact on student outcomes, and (3) employ more quantitative research methods that could serve as an assessment tool to reliably access components of the TPACK framework within the context of teacher training courses and provide valuable insight into the development of teachers' TPACK.

From the practical point of view, the findings from the study could favour the design of suitable teacher courses helping teachers to imagine the contingencies how to use the potential of educational technology in the physics classroom and develop an open mind for using a variety of approaches and strategies with their students. Starting from an understanding of the manner in which technology and content influence and constrain one another, teacher must comprehend which technologies are best suited for addressing which types of subject-matter learning, and how content dictates or shapes the technological application – and vice versa. In relationship to disciplinary contents, they need to know, how to help students meet particular curriculum content standards using educational technologies appropriately and finally and they have to possess knowledge of pedagogical techniques to use technologies in constructive ways to teach content focusing on conceptual understanding and self-regulated learning of their students.

## REFERENCES

- Archambault, L., & Crippen, K. (2009). Examining TPACK among K-12 online distance educators in the United States. *Contemporary Issues in Technology and Teacher Education*, 9(1), 71-88.
- Balanskat, A.; Blamire, R.; Kefala, St. (2006). The ICT Impact Report. *European Schoolnet*.
- Deci, E. L. & Ryan, R. M. (1994). Promoting self-determined education. *Scandinavian Journal of Educational Research*, 38 (1), 3-14.
- Harris, J., Mishra, P., & Koehler, M. (2009). Teachers' technological pedagogical content knowledge and learning activity types: Curriculum-based technology integration reframed. *Journal of Research on Technology in Education*, 41(4), 393-416.
- Hughes, J. (2005). The Role of Teacher Knowledge and Learning Experiences in Forming Technology-Integrated Pedagogy. *Journal of Technology and Teacher Education*. 13 (2), 277-302.
- Koehler, M. & Mishra, P. (2005). What happens when teachers design educational technology? *Journal for Educational Computing Research*, Vol. 32(2). 131-152.
- Koehler, M. J., & Mishra, P. (2008). Introducing TPACK. In J. A. Colbert, K. E. Boyd, K. A. Clark, S. Guan, J. B. Harris, M. A. Kelly & A. D. Thompson (Eds.), *Handbook of Technological Pedagogical Content Knowledge for Educators* (pp. 1-29). New York: Routledge.
- Koehler, M. J., Mishra, P. & Yahay, K. (2007). Tracing the development of teacher knowledge in a design seminar: Integrating content, pedagogy and technology. *Computers & Education*, 49, 740-762
- Krapp, A. (2002). An educational-psychological theory of interest and its relation to SDT. In E.L. Deci & R.M. Ryan (Eds.), *Handbook on self-determination research*, p. 405-427. Rochester.: University of Rochester Press.
- McDermott, L.C., (1996). *Physics by Inquiry. An Introduction to physics and the physical Sciences*, Vol. 2, Wiley, New York.
- Mishra, P., & Koehler, M. J. (2006). Technological pedagogical content knowledge: A framework for teacher knowledge. *Teaches College Record*, 108(6), 1017-1054.
- Niess, M. L. (2005). Preparing teachers to teach science and mathematics with technology: Developing a technology pedagogical content knowledge. *Teaching and Teacher Education*, 21, 509-523.
- Prenzel, M. (1996). Bedingungen für selbstbestimmtes, motiviertes und interessantes Lernen im Studium. [Conditions for self-determined and interest-based learning in higher education]. In J. Lompscher & H. Mandl (Eds.), *Lehr- und Lernprobleme im Studium [Problems of teaching and learning in higher education]*, p. 11-22. Bern: Huber
- Prenzel, M. (2001) In: M. Prenzel, R. Duit, M. Euler, M. Lehrke and T. Seidel, Editors, *Erhebungs- und Auswertungsverfahren des DFG-Projekts "Lehr-Lern-Prozessen im Physikunterricht – eine Videostudie"*, Technical report of the video study on physics instruction of the DFG Program, Leibnitz-Institut für die Pädagogik der Naturwissenschaften (IPN), Kiel, Germany (2001).
- Sandholtz, J. H., Ringstaff, C., & Dwyer, D. C. (1997). *Teaching with technology: Creating student-centered classrooms*. New York: Teachers College Press.
- Thornton, R. and Sokoloff, D., (1990). Learning motion concepts using real-time microcomputer-based laboratory tools, *American Journal of Physics*, 58, 858-867.
- Urban-Woldron, H. (2008). Comparative Meta-Analysis of Elearning: Teaching and Learning with new media. Project report. IMST Fund. *University of Klagenfurt*, Austria.

Dr. Hildegard Urban-Woldron  
University of Vienna

Austrian Educational Competence Centre Physics  
1090 Vienna, Währingerstr. 17  
Email: [hildegard.urban-woldron@univie.ac.at](mailto:hildegard.urban-woldron@univie.ac.at)

Univ. Prof. Dr. Martin Hopf  
University of Vienna  
Austrian Educational Competence Centre Physics  
1090 Vienna, Währingerstr. 17  
Email: [martin.hopf@univie.ac.at](mailto:martin.hopf@univie.ac.at)

## References

- Aydin, O. (2007). *Assessing tenth grade students' difficulties about kinematics graphs by a three-tier test*. Unpublished Master Thesis, Middle East Technical University, Ankara, Turkey.
- Cataloglu, E. (2002). *Development and Validation of an Achievement Test in Introductory Quantum Mechanics: The Quantum Mechanics Visualization Instrument*. Unpublished PhD Thesis, The Pennsylvania State University.
- Chen, C. C., Lin, H. S., & Lin, M. L. (2002). Developing a two-tier diagnostic instrument to assess high school students' understanding- the formation of images by plane mirror. *Proc. Natl. Sci. Coun. ROC(D)*, 12(3), 106-121.
- Eryılmaz, A., & Sürmeli, E. (2002). Üç-aşamalı sorularla öğrencilerin ısı ve sıcaklık konularındaki kavram yanlışlarının ölçülmesi. *Proceeding of V. Ulusal Fen Bilimleri ve Matematik Eğitimi Kongresi, Ankara*, 110-115.
- Goldberg, F. M., & McDermott, L. C. (1986). Student difficulties in understanding image formation by a plane mirror. *The Physics Teacher*, 24(8), 472-481.
- Goldberg, F. M., & McDermott, L. C. (1987). An investigation of student understanding of real image formed by a converging lens or concave mirror. *American Journal of Physics*, 55(2), 108-119.
- Hammer, D. (1996). More than misconceptions: Multiple perspectives on student knowledge and reasoning, and an appropriate role for educational research. *American Journal of Physics*, 64(10), 1316-1325.
- Hestenes, D., Wells, M., & Swackhamer, G. (1992). Force Concept Inventory. *The Physics Teacher*, 30, 141-158.
- Hestenes, D. & Halloun, I. (1995). Interpreting the force concept inventory. *The Physics Teacher*, 33, 502-506.
- Kaltakci, D., & Didis, D. (2007). Identification of pre-service physics teachers' misconceptions on gravity concept: A study with a 3-tier misconception test. In S. A. Çetin, & İ. Hikmet (Eds.), *Proceedings of the American Institute of Physics, USA*, 899, 499-500.
- Komorek, M., & Duit, R. (2004). The teaching experiment as a powerful method to develop and evaluate teaching and learning sequences in the domain of non-linear systems. *International Journal of Science Education*, 26(5), 619-633.
- Osborne, R. J., & Gilbert J. K. (1980). A method for investigating concept understanding in science. *European Journal of Science Education*, 2, 311-321.
- White, R., & Gunstone, R. (1992). *Probing understanding*. London: The Falmer Press.
- Osborne, R. J., & Gilbert J. K. (1979). Investigating student understanding of basic physics concepts using an interview-about-instances approach. *Research in Science Education*, 16, 40-48.



## **Community of prospective primary teachers facing the relative motion and PCK analysis**

Marisa Michelini, Lorenzo Santi, Alberto Stefanel, Stefano Vercellati

michelini@fisica.uniud.it, lorenzo.santi@uniud.it, alberto.stefanel@uniud.it, vercellati@fisica.uniud.it

Research Unit in Physics Education of the University of Udine

### **Introduction**

The first observations of the world done by children are related with motion of objects. Most of the perceptual aspects are activated during primary school and were subject of studies concerning the psychological perception of motion (Johansson 1975, 1985; Bruce, Goldstein 1989). For this reason, it is important to face the physic interpretation of motions already during primary (Michelini 2005; Goldberg et al. 2010; Castells et al. 2010; Ross, Otero 2010; Brussolo, Michelini 2010).

Many learning problems on this subject, as the identification and interpretation of the role of the reference frame, the distinction between trajectory and space-time and velocity-time graph (Sokoloff et al. 1997, 2007; Beichner 1994), the vector nature of quantity as velocity and displacement (McDermott & Redish, 1999), are related to the use of a standard reductionist approach that start with the study of the particular case of the one dimensional uniform motion (Hammer 1989). The construction of a global vision of the physical quantities that describe the motion requires a non-reductionist approach (Karplus, 1977). It provides the opportunity to introduce the vector nature of the kinematic quantities since from the earlier analysis of motions. In fact, even pupils are able to reconstruct step by step the motions through the representation of the displacements done in equal time intervals. In particular, the contexts opened by this approach allow to study the relative motion, composition and decomposition of motion, which often are not enough stressed in the traditional one dimensional approach (Saltiel, Malgrande 1979; Viennot 1996; Castesl et al. 2010). This open a challenge in primary teachers' formation, usually with poor scientific preparation and competencies in active learning strategies.

In this prospective, a specific IBL learning path for primary was designed founding kinematic of motion and relative motion in a non-reductionist framework To allow primary teachers to introduce effectively this approach into their classrooms, a teaching formation course was designed in the prospective of PCK (Pedagogical Content Knowledge) (Schulman, 1987; Magnusson et al. 1999; Abd-El-Khalick 2006). Our research work was done in the framework of PCK, to investigate the research questions presented below.

### **Research Questions**

With respect of our formative module on kinematic and relative motion, we analyzed the following research questions:

- RQ1 How do prospective primary teachers (PPT) face the conceptual knots related to reference frames and relative motions?
- RQ2 How do PPT proposed to face with pupils these learning knots?
- RQ3 Which are the still open CK and PCK aspects?

### **Context, instrument and methods**

During the academic year 2009-2010, was held a specific module on kinematics and relative motions in the context of the Physics Education course at the University of Udine –using participated lessons. In this teaching module, the study of motions in everyday contexts was addressed in 2 or 3 dimensions. Using games and visualization tools, the initial formal description of the reference frame and the quantities related to the description of motion are constructed. From

the first formal description of the involved entities: the vector nature of position, displacement, velocity, and acceleration; their mutual distinction and the representation of motions in the physical space or in abstract graphs; the composition and decomposition of motions. The formative module involved 105 prospective primary teachers. The average age was 22 years old.

At the end of the course, a PCK-based post-test was scheduled for the week next to the end of the lessons. To give answers to our research questions, we analyze here what emerge from this post test. The analysis of data was performed defining a priori categories, rearranged a posteriori. In according to qualitative research criteria, for each question we classified the answers of prospective teachers in categories emerging from the data; then the distributions of answers among those categories were analyzed.

## The post-test

The PCK-based test consisted of 7 items: 2 on CK and 5 on PCK end a CK item concerning a specific knots. The post-test proposes situations and specific questions investigating the extension of the concept of the prospective teachers on the specific knot considered. Each PCK item was divided in two part: in the first part (the CK part), a particular situation is proposed to the prospective teachers and they have to analyze it, in the second part (the PCK part), the prospective teachers have to analyze a series of fake students' questions, individuate the conceptual knot(s) which one of them is related and propose a way to face these knots in classroom. The item 2-3-4 reported in Fig. 1 and Fig.2 are typical PCK questions. In the following are analyzed data emerging from these questions.

Item 1 is concerning the role of the reference frame in the description of everyday motion (bus trip), Item 2 is related to the distinction between position displacement and velocity (analysis of a stroboscopic image), Item 3 is about the description of a vertical motion (discussion of the corresponding graphs) and Item 4 is related to the relative motion of an object placed on a medium that is in motion with respect to a fixed reference frame (the motion of a boat driven by a current).


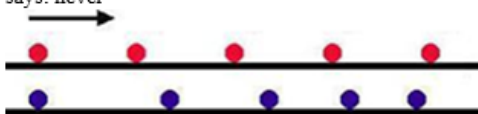
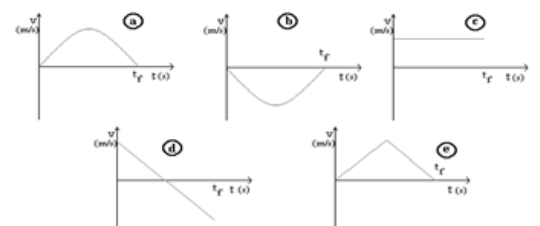
<p><i>Item 1.</i> A bus trip start from Udine. The stops are Cervignano del Friuli, Trieste, Postojna, Ljubljana, Kranj, Klagenfurt, Villach. The map below shows the places touched on the journey. On the maps are represented the wind-rose and scale for distances.</p> <p>1.1 Choose a reference system and it draws on the map          1.2 Represent the position vectors of the different stages: Cervignano del Friuli, Trieste, Postojna, Ljubljana, Kranj, Klagenfurt, Villach          1.3 Represent the displacement vectors for each stage          1.4 The time of travel plan is: Udine: 8.00 h; Cervignano: 8.20 h; Trieste: 9.00 h; Postojna: 10.00 h; Ljubljana: 10.30 h; Kranj: 10.50 h; Klagenfurt: 12.30 h; Villach: 13.30 h</p> <p>Construct the space-time diagram of the motion of the bus.</p>	
<p><i>Item 2.</i> Ex 2) A teacher shows to its students the diagram below where there are represented stroboscopic image of two spheres that go right along two parallel paths. She asks to his students: when the two spheres have the same speed.</p> <p>One child says: only on departure; A girl says, between the second and third position; Another child says: never</p>  <p>2.1 Which is/are the conceptual knot(s) highlight by the answers?          2.2 How could you face it in the classroom?</p>	<p><i>Item 3.</i> A teacher proposed to his students the following situation: A ball is thrown vertically into the air and then take in hand when it returns to the height from which it was throw. Students must choose which of the following velocity-time graphs best describes the motion of the ball. Justify your answers and specify the trajectory followed by the ball.</p>  <p>Discuss each graph.</p>

Figure 1. Items 1-3 of the PCK questionnaire: situations proposed on specific questions to PPT

Item 4. A boat is sailing north at 40 km/h in a sea affected by a current to the east at 30 km/h constant.

4.1. Representing the boat speed and current

4.2. Represent the movement of the boat after 3 hours.

4.3. Represents in a v-t graph the boat and the current speeds

4.4. Explanation of drawing: Explain your choices for performances 4.1 and 4.2

4.5 What kind of motion are followed by boat during the three hours of navigation...

4.5.1 ... compared to the seashore? Explain your answer.

4.5.2 ... compared to the current? Explain your answer.

4.6 To some students are asked to represent the motion of the boat and explain it.

They perform the following considerations

S1: I cannot do represent motion without a compass

S2: If it isn't drawn or indicated the seashore, I don't know how to do

S3: How can I represent time in a drawing of the physical space?

S4: Represent velocity at constant intervals of time is the same than represent the movement

S5: You can not represent the velocities in physical space, I must do a velocity- time graph

S6: Compared to what I have to consider the velocity?

Helping each student, explaining how (what do you say to each student?)

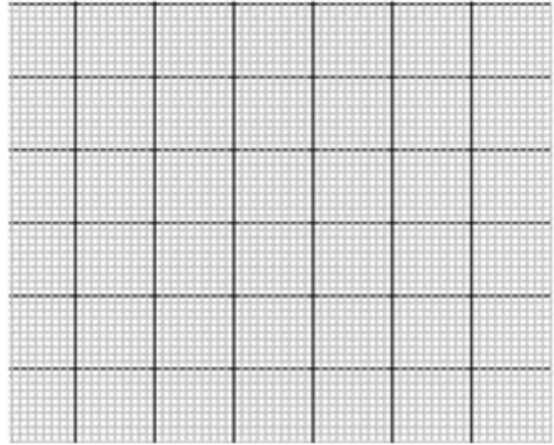


Figure 2. Item 4 of the PCK questionnaire

### Data and data analysis

Item 1. Answering question 1.1 the origin of the reference frame was chosen in almost all of the cases (92%) in coincidence with the starting point of the trip (Udine); in the remaining cases the origin was put in the lower-left corner of the picture (3%) or into the water under Udine (5%). The axes were often indicated (88%), but there was a significant group that drew half-axis (10%) or only one axis (2%). The axis orientations were highlighted by 72%, while (18%) did not highlight the orientation or dual-oriented as the wind-rose (10%). The majority (53%) included the two labels on the axis (E-N 33%; x-y 20%), two marginal groups did not indicate any label (25%) or indicate the complete set of cardinal points N-S-O-E (18%).

The students who answered to questions 1.2 and 1.3 (78%) drew the position vectors. Among these, 58% indicated the displacement vector, while 12% represented only a segment; the remaining 8% drew only the positions of the stops or the traveling as a segment or the position vectors. In question 1.4, concerning the construction of the space-time diagram: the 61% choose to represent the graph of the distance from the origin of the journey; 22% interpreted the delivery constructing the time-space diagram by representing on the y-axes the linear distance traveled by the coach; 9% represented the space-time graph considering equidistant one leg of the journey to the next one; the remaining did not reply.

Table 1: Categories of Item 2	%
<b>HIGHLIGHT A KNOT</b>	<b>65</b>
Def. Of velocity	25
Difference: velocity – acceleration	17
Local vision of the motion	14
Diff. between velocity and trajectory	6
Do not justify	2
And did the CK analysis	1
<b>EXPLICIT A LEARNING GOAL</b>	<b>7</b>
<b>DO A CK ANALYSIS OF THE PROBLEM</b>	<b>5</b>
Rectilinear uniform motion	4
While $Ds/Dt$ are equals	1
<b>NR</b>	<b>23</b>

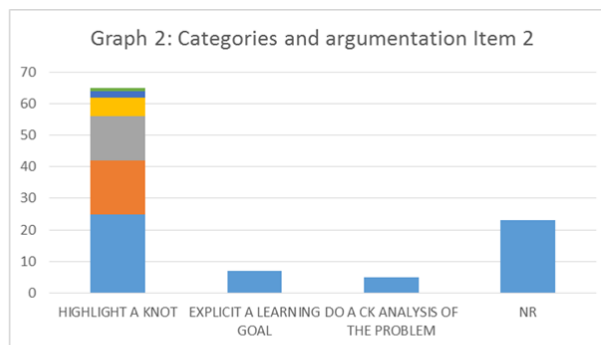


Figure 3. Answers categories and argumentations to Item 2

*Item 2.* The 77% of the PPT replied to this item as shown in Fig. 3: 65% focalize on only one learning knot, 7% explicit just one learning goals, 5% do a CK analysis of the situation without referring to the pupils answers. Between them 57% proposed an active intervention as games or practical activities centered on the highlighted knot (16% explicit how they are related to the specific knot, 19% describe only the activity and 22% give only a vague description of the way in which perform the proposed activity), 18% described an activity that involves learning knots that are different from the individuate one, 3% suggested to construct the space-time graph of the motion. It emerge the attitude to analyze the problematic situation in a single dimension prospective highlight the need to construct a multi-dimensional analysis of situations both on the subject matter perspective and relate to the educational one.

*Item 3.* The correct graph (d) was identified by 11%, while the main distractor was the graph (a) chose by 47%, which represents the right space-time graph. The distribution of the other answers is shown in Fig. 4. The difficulties in the reading of the graph was highlighted also by the 32% of the students who did not replies.

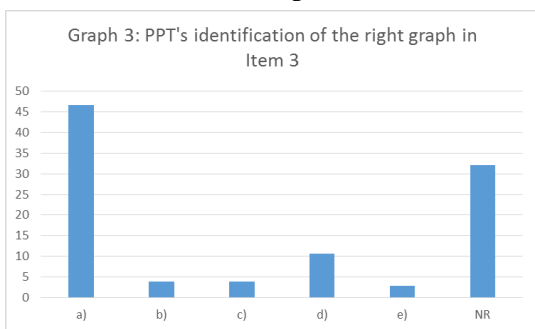


Figure 4. Graph individuate as right in Item 3 by PPT

A significant group (40%) analyzed the graphs doing references to the ascent and descent motions of the ball, in the remaining 52% described the individual graphs or did not reply (8%). Despite the approach that they used, mostly students described the graph in terms of acceleration or change of velocity (28%+15%). In some cases, some PPT did not distinct between trajectory and graph (16%+24%), or between space-time graph and velocity-time graphs (4%+1%) – Fig.5. This result could be related to the well-known problem related to the multi-representation of motions and, in particular, to the distinction between  $v-t$  graph and trajectory.

*Item 4.* Concerning questions 4.1-4.4 related to the description of the motion of the boat driven by the current: 85% of the students do a composition between the velocity vectors and 59% explicit the way in which the compose them, but only half of the students take in consideration the entire length of the motion (51%). One third of the students (32%) represent also the reference frame, showing how strong is the attitude of PPT to leave implicit the reference system.

As concern question 4.5.1, 49% replied that the motion of the boat is rectilinear and uniform; 13% described the motion as uniformly accelerated (because the distance between the boat and the seashore continuously increase); 5% said that it depends by the seashore location; 2% did not specify the type of motion but highlight only that a composition between the two motion is needed; 31% did not replay to this question.

Table 2: Categories to Item 3	%
<b>DESCRIBE THE GRAPHS</b>	<b>52</b>
Description in terms of variation of velocity	28
No distinction Trajectory, v-t graph	16
uniform accelerated motion	4
No distinction v-t, s-t	4
<b>ANALYZE THE MOTIONS OF THE BALL</b>	<b>40</b>
No distinction Trajectory, v-t graph	24
Description in terms of variation of velocity	15
No distinction v-t, s-t	1
<b>NR</b>	<b>8</b>

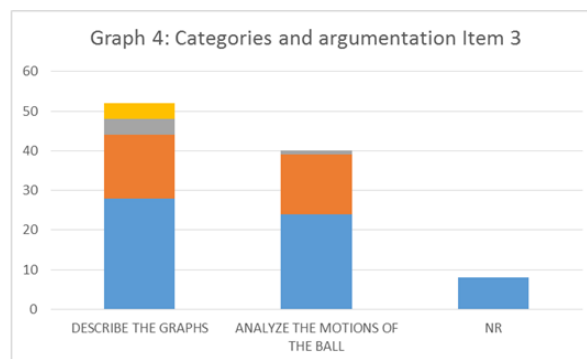


Figure 5. Categories and argumentation for Item 3

As concern question 4.5.2 about the description of the motion of the boat with respect to the current, the number of the correct answers decrease: 35% identified the motion as rectilinear uniform, 10% as rectilinear uniformly accelerated, 48% did not answer to this question, and 7% replied “perpendicular to the current”.

Concerning the discussion on the fake students’ answers 4.6.SX, 75% of PPT emphasized the importance of the definition of a reference frame, however often they did not describe which reference frame they consider. In fact, commenting 4.6.S1, PPT assured that the compass is not needed (68%) and, commenting 4.6.S2, that the seashore position is not important (52%). Aspect that highlight a particular critical point in the PPT formation. The problem of the definition of the reference frame, and, moreover, the formulation of a description it, is one of the main problem in literature (Sokoloff et al. 1997, 2007) and it is pivotal that PPT will be able to face it with their students to understand the role of the reference frame into the description of the motion. In analogy with the Item 3, it emerges from the 4.6.SX questions how PPT, by facing of the PCK analysis of the fake students’ answer, highlight the same difficulties shown in the CK part and how there is no more an investigation of the learning knots, but the PPT attitude is toward the expression of a judgment about the correctness (or not) of the students’ answers.

## **Discussions and conclusions**

For what concern the CK part, PPT face the conceptual knots related to reference frames and relative motions (RQ1) it emerge how: A) PPT are able to setup a well-defined reference frame even if there is a remaining tendencies to use a local approach into the definition of the reference frame origin and in the axes labeling [Item 1]; B) the multi-representation of the motion is still a problem in particular for what concern the distinction between trajectory and space-time and velocity-time time graphs [Item 3]; C) in many cases, PPT can apply in an effective way the step by step construction of the motion by mean of displacement vectors [Item 4].

Looking at the PCK aspects (RQ2): A) when they had to face a PCK activity of a well mastered content, almost all of the PPT individuate one of the main knots behind the proposed question and is able to propose a specific activity that, in the majority of the cases, is effectively focused to address in classroom the knots individuated [Item 2]; B) when they consider a question concerning a not well mastered content, PPT tend to judge the correctness of the pupils answer instead of looking for learning knots and analyze their origin and, in such a situation, they tend to propose generic learning activity [Item 4]; C) in some cases, also when they evidence CK competencies, do not link the activities proposed to address with student the specific knot considered, not going beyond the generic indication “with experiments”, “with games”, or proposing specific games and building activity but not focused on the knot identified [Item 2].

For what concern the still open aspects related to teachers CK and PCK (RQ3) we can summarize them as follow: A) the main problematic CK aspects for the prospective teachers are the construction of a system of arbitrary reference frame in a given context (referring to different systems, or not related to any specific system) [Item 1], the reference to manage multiple reference frames in relative motion on with respect to the other [Item 4], the handle of the physical multi-representation [Item 3]; B) the main PCK open aspects are the difficulties in the recognition of different learning knots included into the students’ sentences [Item 2, Item 4], in the construction of a set of activities (and not just one) that can be used to propose to students a same aspect form different point of view, or face on a same experiment the different knots involved [Item 2,].

As indication on how improve our formative module, emerge from one side the need to put attention on the study of relative motion and emphasis on the construction and the role of the

reference frame. For what concern the PCK aspects, it emerge the need to integrate in the education laboratory of part devoted to design co-projected single activities as well micro learning path. The results of the research presented to indicate that the formation CK is a precondition for being able to build significant PCK. At the same time, the actual construction of PCK also requires an extensive analysis of proposed activities to be able to watch the same phenomenon from different points of view, or with a variety of alternative proposals. In addition, the skill of being able to focus on a teaching of a concept called a node requires a specific design tasks.

## Bibliography

- Abd-El-Khalick, F. (2006) Preservice and experienced biology teachers' global and specific subject matter structures: Implications for conceptions of pedagogical content knowledge. *Eurasia Journal of Mathematics, Science and Technology Education*, 2(1), 1-29.
- Beichner, R. J. (1994) Testing student interpretation of kinematics graphs, *AJP*, 62 (8), pp. 750-762.
- Bruce E. Goldstein (1989) *Sensation and Perception* (Belmont, California: Wadsworth, p. 314.
- Brussolo, L. e Michelini, M. (2010) Studiare il moto per un'educazione stradale che forma educazione scientifica, [http://www.formativamente.com/files/moto\\_edu\\_strad.pdf](http://www.formativamente.com/files/moto_edu_strad.pdf).
- Castells, M., Konstantinidou, A., Cerveró, J.M. and Cabellos M. (2010) A dialogical and convincing approach for teaching Galilean relativity of motion: transparencies, video and multimedia resources, at [http://www.fisica.uniud.it/URDF/mptl14/ftp/full\\_text/T4\\_86\\_Castells.pdf](http://www.fisica.uniud.it/URDF/mptl14/ftp/full_text/T4_86_Castells.pdf).
- Davis, E.A., Petish, D., and Smithy, J. (2006). Challenges new science teachers face. *Review of Educational Research*, 76(4), 607-651.
- Goldberg F., Otero V., Robinson S. (2010) Design principles for effective physics instruction: A case from physics and everyday thinking, *Am. J. Phys.* 78 (12) 1265-1277.
- Hammer, D. (1989) Two approaches to learning physics, *Physics Teachers*, 664-670.
- Johansson, G. von Hofsten Hofsten, C. Jansson G. (1980) Event Perception, *Annual Rev. of Psychology*, 31, pp. 27-63.
- Johansson, G. (1975). Visual motion perception. *Scientific American* 232, January, 76-88.
- Johansson, G. (1985). About visual event perception. In RE Shaw & WH Warren (eds), *Persistence and change*. Hillsdale, NJ: Lawrence Erlbaum Associates.
- Kahn & Thornton, R. (2009). Introducing Scientific Concepts of Motion and Mathematical Concepts of Graphing Using a Motion Detector in a 2<sup>nd</sup> and 3<sup>rd</sup> Grade Mixed Age Classroom, in *Proceedings of 2009 National Association of Research on Science Teaching*.
- Karplus, R., (1997), Science teaching and the development of reasoning, *Journal of Research in Science Teaching*, 14(2): 169-175.
- Magnusson, S., Krajcik, J. , Borko, H. (1999). Nature, sources and development of pedagogical content knowledge for science teaching. In J. Gess-Newsome, Lederman, N. (Ed.), *Examining pedagogical content knowledge* (pp. 95-732). Dordrecht, The Netherlands: Kluwer Academic Press.
- McDermott, L. and Redish, E.F. (1999) Resource Letter, 'PER-1: Physics Education Research', *American Journal of Physics*, 67 (9): 755-767.
- Michelini, M. (2005). The learning challenge: A bridge between everyday experience and scientific knowledge. *Proceedings of the Third International GIREP Seminar "Informal learning and public understanding of physics,"* 5-9 September, 2005, Ljubljana, Slovenia, 18-38.
- Ross, M. and Otero, V. (2010) Authentic science activities in the primary level classroom, *Il Nuovo Cimento C*, 03, pp 13-20.
- Saltiel, E. et Malgrande, J.L. (1979) Les raisonnements naturels en cinématique élémentaire, *Bulletin de l'Union des Physiciens*, 616, pp. 1325-1355.
- Shulman, L. (1987). Knowledge and teaching: Foundations of the new reform. *Harvard Educational Review*, 57(1), 1-22.
- Sokoloff, D. R., Thornton, R. K. and Laws, P.W. (2007) RealTime Physics: Active Learning Labs Transforming the Introductory Laboratory," *Eur. J. of Phys.*, 28, S83-S94.
- Sokoloff, D.R. and Thornton, R.K. (1997) Using Interactive Lecture Demonstrations to Create an Active Learning Environment, *The Physics Teacher* 35: 6, 340.
- Viennot L. (1996) Raisonner en physique, la part du sens commun, De Boeck, Bruxelles, pp. 62-72.

# Chapter 4

---

Thematic analysis



## **4.1 Simple And Beautiful Experiments IV By LADY CATS And Science Teachers' Group**

**Masa-Aki Taniguchi, Tomoki Hashimoto, Takanari Sasaki, Hiroshi Kawakatsu, Tatsuhiro Uchida, Jun-Ichiro Yasuda, Kazuhiro Tokuda**

*Comprehensive Scientific Education Center, Meijo University, Nagoya, 468-8502, Japan*

**Masako Tanemura**

*Faculty of Education, Osaka Kyoiku University, Osaka, 543-0054, Japan*

**Fumiko Okiharu**

*Faculty of Education, Niigata University, Niigata, 950-2181, Japan*

### **Abstract**

We propose and exhibit simple and beautiful science experiments that can demonstrate the principles of physics to fascinate students' interest. These experiments are made easily and low-cost. We mainly choose popular experiments among children which we actually used in our classes and events. It is meaningful to spread good teaching materials to the world and share them with teachers all over the world.

### **Introduction**

LADY CATS<sup>1-3)</sup> (LADY Creators of Activities for Teaching Science) is an organization of science teachers from high school teachers to university researchers like STRAY CATS. Our group includes a lot of female teachers, which is rather unusual in the field of physics. We aim to encourage both students and teachers who are not interested in physics.

Recently in Japan, many primary school teachers feel uncomfortable with teaching science because they have studied only general science and they feel their knowledge may be not enough to teach science, especially physics. A lot of girls do not study physics in high school or university. As for the choice of the course that becomes a teacher at the elementary school, there are a lot of girls. Therefore there are many women teachers at primary schools. Moreover there are fewer women physics teachers in higher education.

LADY CATS was formed in 2005 in order to change these tendencies through the activities. Recently, LADY CATS have presented experiment teaching materials in international conferences while cooperating with male teachers. We dedicate to exhibiting simple and beautiful science experiments that demonstrate the principles of physics in order to fascinate students' interests. These experiments are low-cost and easily made by using everyday necessities. We are aiming at development, the exploration, and the spread of these good experiments.

Outline of our teaching material

We held the workshop of a physics experiment teaching material at 10:30 – 12:30 on Aug. 24 in GIREP-ICPE-MPTL 2010. At first we introduced and demonstrated each experiment simply. After that, we explained each experiment more precisely at each table. About 80 people came in our workshop. We took the questionnaire that asked which the most impressive experiment was, whether the participant was going to use it for the class or not, and so on.

In the following we briefly show the outline of our experiments.



### Hearing “voice of atom”

This is an experiment using the Barkhausen effect of a ferromagnetic material.<sup>4)</sup> When a ferromagnetic material is magnetized, the magnetic noise is generated because the magnetic domain wall in the material moves in discontinuity. We easily hear the Barkhausen noise by making the following devices<sup>5)</sup>: The coil is rolled in the ferromagnetic such as iron, the edge of the coil tied to the amplifier with a loudspeaker. If the magnet is brought close to the ferromagnetic, the Barkhausen noise is generated and heard from the loudspeaker. This experiment is interesting because we can hear the movement of such a microscopic magnetic domain as macroscopic noise. It seems to be educationally worthy.

In this experiment, it is important that the noise from the speaker is not simply generated by the induced current but the Barkhausen noise. The noise is generated only when the magnet is brought close to ferromagnetic first. Afterwards the noise is not generated when the magnet is brought close again or is kept away if we do not turn around the magnet.

### Faraday’s Motor (Unipolar Motor)

This is a simple motor made with the battery, the magnet, and the wire.<sup>2, 3, 6)</sup> In this time, we have improved the material so that the child may easily make it. We decided to cover the ferrite magnet with the aluminum foil and to use it for the grade-schoolers whose powers are weak. This is because the neodymium magnet often used to make the unipolar motor has a superpower and it is dangerous to handle it for children. We also changed to use the aluminum wire that was able to be bent freely because it was softer instead of the copper or the enameled wire.

### Curious Cup

This is a folk craft of Ishigaki Island, Okinawa, Japan. It looks like a normal cup, and water never runs out when you fill with half-full of it. However, once you fill the cup full with water, water runs out completely through the bottom pipe.<sup>7)</sup> This curious cup reminds you of the following proverbs: “Feed by measure and defy the physician.” Or “Kill the goose that lays golden eggs.” The pressure is the same at any points at the same level in the fluid. While you fill the cup halfway with water, it stays since the surface of water does not exceed the top of the straw.

However, if you fill up the cup with water and the surface of the water becomes higher than one in the straw, water runs through the straw because of the pressure.

### USB Camera for Plastic Bottle Microscope

This is a camera to take the image of the PET bottle microscope<sup>2, 8)</sup> into PC. How to make is as follows: we remove the front panel of USB camera on the market, and apply a handmade attachment in which the clothespin is installed. We only have to fix the PET bottle microscope to this clothespin and to focus the microscope.

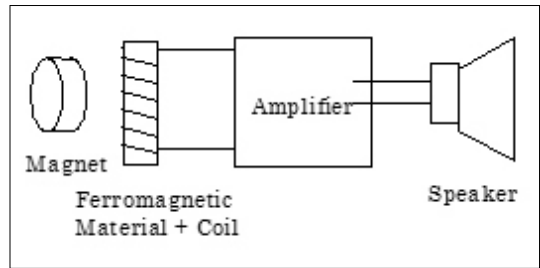


Fig. 1 Experimental device hearing the “voice of atom”.



Fig. 2 Faraday’s Motor.

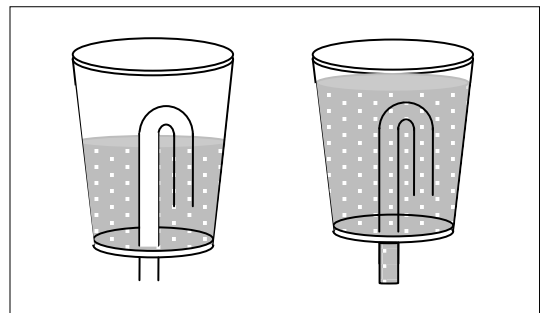


Fig. 3 Principle of the curious cup.

Many people can observe one specimen material at the same time when the image of the microscope is taken into PC and it projects to the screen. Therefore an educational meaning is large.

### Rolling Down a Hill

It is a well-known experiment that rolling various objects down a hill, and predicting which object rolls down the hill fastest<sup>9,10</sup>. We improved the experiment as a lecture demonstration to understand the moment of inertia. We prepared a sphere, a shell, a cylinder, and a cylindrical shell which are different in the mass and the radius of rotation. We rolled the chosen two objects down a hill, and have the audience predict which object rolls down the hill faster.

The characteristic of this experiment is that we can explain the velocity of the rolling objects *both by intuition and by calculation*. The velocity of the rolling object depends on the moment of inertia. Since the structures of the objects we prepared are homogeneous and simple, we can easily intuit and calculate the moments of inertia. Thus, we can compare the experiment with the intuition and the calculation by “our hand”.

We discussed with the audience how should we discuss the experiment with students and how should we explain to students the effects of the air resistance and the friction and so on.



Fig. 4 USB Camera for Plastic Bottle Microscope.

### Spectrum Kaleidoscope

This is a kaleidoscope without using the mirror.<sup>11</sup> Materials are two paper cups, grating seats, and black drawing papers. A cross hole is made for the bottom in one of paper cups. The other bottom (“Eyepiece”) is cut out square, where the grating seat is stuck. For shading, we paint the bottom of two cups black and fixed a black drawing paper internally. After that we match two cups and to fix them. We can see a beautiful spectrum pattern by diffraction when we peep at eyepiece.

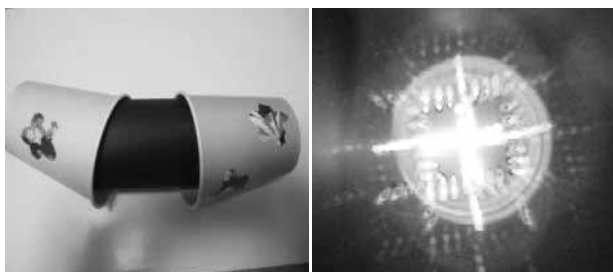


Fig. 5 Spectrum Kaleidoscope.

### The Cartesian Diver

The Cartesian diver is a traditional teaching material invented in the 17th century.<sup>12</sup> We put a weight to one end of a small container. We put water into the container in such that the other end of it floats on the water. We put the container into a plastic bottle filled with the water. The Cartesian diver sinks when the PET bottle is pushed, and floats again when the PET bottle is released. Ups and downs are decided depending on the balance of the buoyancy and the gravity that hangs to the Cartesian diver. Before pushing the PET bottle, we make children consider how the container moves and how the volume of the air in the container changes. This is a good experiment for students who start to study physics. This also appeals to the juvenile by mysteriously of the phenomenon.

### The PET fiber

This is an experiment that applies the cotton candy machine.<sup>13,14</sup> We use the tiny pellet by cutting the PET bottle when a pet fiber is made, although granulated sugar is used as a raw material when the cotton candy is made. We put the pellet in the can, and we heat it with the spirit lamp. A plastic fiber comes out from the hole

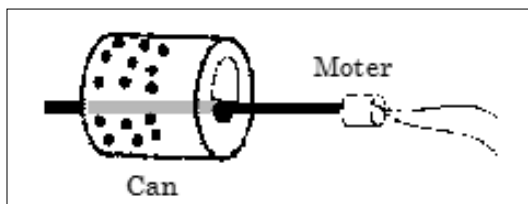


Fig. 6 PET fiber machine.

of the can when it is rotated by the motor. The fiber like the fleece can be made by collecting this. In the workshop many people were interested in being able to make the fiber like the fleece with familiar materials.

### **Handmade Loudspeaker**

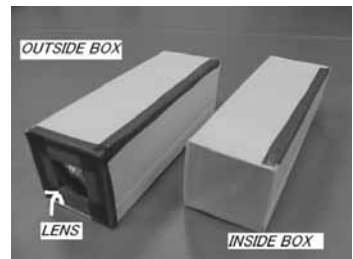
This is an easy speaker that used the paper cup, the enameled wire, and the magnet.<sup>15)</sup> Because the current output from player's output terminal is a change current, the changing magnetic field is generated by the coil. The magnet and the bottom of the paper cup vibrate by the interaction with the magnetic field and we can hear the sound. Because it had been valued that even children were able to make it easily, the sound was a little small. The improvement is a future task.



**Fig. 7** Handmade Loudspeaker.

### **Simple Camera**

This is an easy camera with two milk cartons and lenses. This is a good experiment to learn how the lens makes the image and the mechanism of the camera. When we move the inside box and adjust the focus, the image is beautifully made on the screen pasted to the inside box. There were a lot of participants who had the concern.



**Fig. 8** Simple Camera

### **PET Bottle Water Rocket**

This is a water rocket made from the PET bottle.<sup>18)</sup> This is an interesting teaching material that attracts children. This experiment also helps to understand the action and the reaction. In this time, we gave priority to the device of the launch pad. We use the rubber plug to connect a water rocket and a pump. There is room for improvements in the control of the launching and respect of durability.

### **Concluding Remarks**

We introduced these teaching materials at the hands-on workshop in GIREP-ICPE-MPTL 2010. Some of our teaching materials are familiar in Japan, but are not known in the foreign countries. We think it is meaningful to spread good teaching materials to the world and share them with teachers all over the world.

We mainly choose popular teaching materials among children which we have actually used in our classes or events. These teaching materials are good, because many children have their interests in them. Moreover, we think "When we use good teaching materials such as these, children are pleased and will have the interests in physics." In order to prove this hypothesis, it is necessary to measure the educative effect of them. It is difficult to measure the educative effect of one teaching material. It becomes one index of the educative effect whether teachers, who are the professional of the education, take the teaching material to their classes or not. If a certain teaching material spreads all over the world, the educational significance of it may be high.

In this workshop we took the questionnaire for the participant. In this questionnaire, we ask which the most impressive teaching material is and whether they are going to use it in their class. We think that it is important to accumulate such data.

## References:

1. Masako Tanemura *et al.*, The Third IUPAP International Conference on Women in Physics, AIP Proceedings, **1119** (2009) 246.
2. Masako Tanemura *et al.*, “Simple and Beautiful Experiments III by Lady Cats and Science Teachers’ Group” Proceedings of the International Conference on Physics Education 2009.
3. LADY CATS and Science Education Group, <http://www.osaka-kyoiku.ac.jp/~masako/exp/ladycats/index.html>
4. H. Barkhausen, Phys. Zeitschrift, **20** (1919) 201.
5. Lecture demonstration manual, Instructional Research Lab, UCLA physics,
6. [http://www.physics.ucla.edu/demoweb/demomanual/electricity\\_and\\_magnetism/magnetostatics/barkhausen\\_effect.html](http://www.physics.ucla.edu/demoweb/demomanual/electricity_and_magnetism/magnetostatics/barkhausen_effect.html)
7. M. Faraday, “Experimental Researches in Electricity”, Uchida Rokakuho (1987) [in Japanese]
8. Y. Miyata, <http://www.info-niigata.or.jp/~ymiyata/others/kyoukun.htm>, [in Japanese]
9. T. Yoshikawa, “Leeuwenhook’s microscope made by plastic bottle”: Monozukuri Handbook No.4, Kasetu-sha (1996) [in Japanese]
10. T. Shimano, M. Koide, Y. Miyachi, “Kororin”: Original Introduction Series3, Kasetu-sha (2003) [in Japanese]
11. M. Mori, Y. Miura, K. Senyo, J. Yasuda, Handbook of Physics Demonstrations for Students in Nagoya University, Study Group on Physics Demonstration in Nagoya University, 2010.
12. S. Danjo, “Fushigitaikan Kagakuzikken” (1999) [in Japanese]
13. A Philosophical Toy, Richard Frazier, <http://www.ed.uiuc.edu/courses/ci241-science-sp95/resources/philotoy/philotoy.html>
14. Aichi-Gifu Physics circle, “Ikiiki Butsuri Wakuwaku Jikken” Nihonhyouronnsya, p101 (2002) [in Japanese]
15. T. Samaki, “Rika Omosiro Jikken - Monozukuri Kannzen Manual” Tokyo Syoseki, p13-17 (1993) [in Japanese]
16. <http://homepage2.nifty.com/pascal/jtool08.html> [in Japanese]
17. [http://www.wit.pref.chiba.lg.jp/\\_kikaku/kouza/2009/youshi/HP090822/pet.pdf](http://www.wit.pref.chiba.lg.jp/_kikaku/kouza/2009/youshi/HP090822/pet.pdf) [in Japanese]

## 4.2 “What Is the Wick in the Candle For?” – An Example of the Methodological Sequence in the “Eureka” Project

**Irena Dvorakova**

*Department of Physics Education, Faculty of Mathematics and Physics, Charles University in Prague, Czech Republic*

**Leos Dvorak**

*Junior Secondary School, Alzirská street, Prague, Czech Republic*

### Introduction

The main aim of the Heureka (“Heureka” means “Eureka” in English) project is to improve physics education in the Czech Republic. Its title suggests the heuristic method of teaching. The Heureka project started in 1991, when several teachers looked for a way of teaching physics in a more interesting and in the same time more effective way. We use the term “Heureka” in Czech to characterize some important features of our approach to teaching and learning.

It does not mean that Heureka is limited to the old “learning by discovering” approach (which is sometimes criticised for ignoring pupils’ preconcepts, the context of learning, etc.). It would be fashionable to claim that Heureka is based on constructivism, “social constructivism” or some such. Surely, there are many common points. But, to be fair, it must be said that the “principles of the Heureka approach” were created by teachers, who were at that time not aware of the latest trends in education in Western countries. Maybe it is sad - but it is interesting to see how the “principles of Heureka” resonate with many ideas and recommendations resulting from these trends and from the area of physics education research. In the above, it was said that the principles of Heureka were “created”. It would be more appropriate to say that these principles emerged. They arose from the work of several teachers and other people deeply perceiving the need to improve the teaching of physics. This work was intensive and lasted for years. At first the Heureka project concentrated on physics education for the age group 12-15. Now it covers a much broader scope. It remains a project for both pupils and students at schools and future teachers. Nowadays it is mainly concentrated on continuing education of physics teachers. The Heureka project is also an example of cooperation between teachers at schools, future teachers, and teachers from the University.

### Some basic principles of the Heureka project

Why might the Heureka project be interesting for people from other countries?

- It started “from below”, without any official support.
- Its basic principles are in agreement with many modern trends in physics education worldwide, in spite of the fact that the authors had at that time very little information about those trends (at the beginning of the 90’s it was very hard to obtain foreign pedagogical literature in the Czech Republic for the teachers). Several of these principles are:
  - A high rate of student/teacher interaction.
  - An inquiry-based approach to teaching.
  - Nature is the final authority, not the words of the teacher.
  - Mistakes are normal and an important part of the learning process.
  - The starting point of teaching is a question.
  - The specific physical terms are defined at the end, as a result of observations.
  - We start from things that children know from everyday life.

## Seminars for teachers

We use these principles in teaching physics not only at school, but also at seminars for teachers and future teachers. We organize several types of seminars (both for new participants and for more experienced teachers) and also an annual conference “The Heureka Workshops” for participants from all types of seminars which is open to teachers both in the Czech Republic and from abroad.



“The Heureka Workshops 2010” – What to do with lenses.

The main characteristics of the seminars for teachers are:

- All seminars are completely voluntary; participants obtain no advancement or benefits at their schools. Their only rewards are their own experiences and the teaching methods, plans of lectures, physics tasks and themes of lab work they obtain during the seminars.
- All seminars are free of charge.
- Seminars of our project take place at a school, so they are very informal. We offer “lodging excluding meals” - participants sleep in their sleeping-bags in classrooms and they have to bring meals with them. In spite of these conditions we have almost 100 active participants.



Seminar for teachers.

### **Example of the methodological sequence**

As an example of the method we offer you a “scenario” of the first physics lesson in the 6th class of a junior secondary school in the Czech Republic (children about 12 years old) – the topic is *Basic properties of the three states of matter*. The material is aimed at teachers who are working in the Heureka project. Although it is written as a lesson plan, it is vital that each single lesson takes shape from the children, their reactions, ideas etc. This material only helps the teacher to lead the children to search and discover. (In the following text the letter T shows the speech of a teacher, the letter P shows an expected answer of a pupil.)

#### ***Physical phenomena studied:***

Solid, liquid, and fluid materials, their properties and comparison

#### ***Required instruments:***

candles, matches, wooden skewer, lead in a can, steel screw, gas burner, laboratory assembly and a grating (over the burner), 2 cans, ice, water, blackened bulb, 2 bigger beakers (1 litre volume), transparent syringe, piece of tinfoil, lighter refill gas (butane or propane-butane) in a container that can spray.

### **First part of the lesson**

Place a candle, a can containing lead and a piece of ice on the table.

T: What is on my table?

P: A piece of ice.

P: A candle.

P: A can with some metal

There are more possible answers (tin for example). It is necessary to realize that students are not capable of distinguishing various metals. The teacher has to accept that it could be any of these metals and then specify that it is lead.

T: Yes, you're right. Tell me what properties are common and what properties are different for those materials.

Write the children's ideas on the blackboard. Use their language; don't rewrite them to the “right physical terminology”.

T: Now we are going to play a bit. Watch me.

Burn the candle and leave it burning for a while, to let the wax melt. In the meantime light the gas burner and start heating the lead.

T: What do you see?

P: The candle is burning.

T: That's true. However, now watch the wax.

P: It flows.

T: The lead has also warmed up, come and look at it.

T: Can a screw swim?

P: No.

T: Well, look.

Put the screw onto the molten lead. Using the skewer you can show the students that even after submerging the screw returns to back to surface.

P: The lead is flowing as well.

P: The screw is swimming on the lead.

T: And now we will think about this piece of ice. Could it also flow?

P: Of course, if we warmed it up it would become water and flow.

Warm up a piece of ice in the beaker. Wait until it melts and becomes water. Pour it out of the can to show it flows. Put the rest of the ice into one can and hold an empty can in your other hand.

T: Now I've got ice in this can. How can I move it into the other can?

P: I will dump it there.

T: Could we dump the solid wax or the piece of lead the same way?

P: Yes, we can.

T: Would the shape of the dumped piece change?

P: No.

T: And what if I fill the can with water. How could I get the water into the other can?

P: The same way.

T: Please come here and show us, how you would do that.

Let the pupil a few times pour the water from one can to another at first with open eyes and after with closed eyes. If someone is really doing badly, it may be necessary to advise him to imagine, how the water is pouring.

In the same manner show, how the liquid wax can be poured (right from the candle into the can) and tell the pupils, that the lead could be poured as well if it is liquid.

T: Here we have a syringe that can be filled with water. How is it possible to ensure that there is water inside?

P: I can see that.

T: Yes. Is there any other way?

P: I can splash it out.

T: True. Has anyone got any other idea?

P: If I block the syringe with my finger, I won't be able to press the piston.

(It is crucial to lead the pupils to find out this answer themselves, because this method is going to be used in following lessons.)

T: Yes, that's true. An appropriate syringe could be filled with molten wax and lead.

Ask pupils about the properties of liquid materials and write them on the blackboard the same way as you wrote the properties of solid materials.

T: We will now write down what we have found out about water, lead and wax.

- Water
- Is hard
- Flows
- Lead
- Is hard
- Flows
- Wax
- Is hard
- Flows

The terms "solid", "liquid" and "fluid" have not been used before. We are creating them now by experience. We write various children's words to describe the state of material because these are exactly the words that the children have used.

T: What more can we do with the water?

Lead the pupils to notice, that water can be "changed" into vapour.

Put a beaker with water above the burner and start heating it. Upon the top of first beaker hold the other one. Its bottom will quickly fog up.

T: Well, we can now list a third quality for the water.

- Water
- Is hard
- Flows
- Creates vapour

T: I will show you some magic.

Prepare a burning skewer. Blow out the candle



In the classroom – Blowing candles.



with a sharp breath and insert the skewer into the rising smoke. The wax vapour will quickly ignite and will set the wick on fire. Let the pupils try it again themselves at their desks. Demand a description of the observed phenomenon before advancing further.

T: Try to describe how to do this experiment successfully.

P: It is necessary to insert the skewer into the smoke.

T: Isn't it strange that the smoke burns so well? Why do we release the smoke from the stove to the chimney and we don't convey it back to the stove?

P: Maybe it is not the smoke, but I don't know what it is.

T: I can help you. Look at this experiment.

Put a piece of wax in a small bowl made from tinfoil. Hold the tinfoil in pliers and put over the burning candle. After a while the wax warms up and some white smoke starts to rise from it. This smoke is the wax vapour and can be easily lit with a burning skewer.

T: Are you able to explain this experiment?

Let the pupils develop, consult and defend their ideas.

T: So we see that the wax vapour exists. Could you now explain the previous experiment when we burnt the candle without touching the wick?

P: Yes, we burnt the wax vapour. We can add this item to the list of properties of wax.

- Wax
- Is hard
- Flows
- Creates vapour

T: We know that both water vapour and wax vapour exist. Do you think that there is also any lead vapour?

P: Maybe yes. I have heard that exhaust fumes are dangerous due to lead vapour.

T: Yes, you are right. It exists, but I'm not able to demonstrate its existence here. However, examine this bulb. Why do you think it is so black?

Show the blackened bulb (usually a burned-out one). Lead the pupils to the conclusion, that the fibre (made of metal) evaporates and that the "black cover" is this vapour which has condensed.

T: Now we can complete our table

- Lead
- Is hard
- Flows
- Creates vapour

## **Second part of the lesson**

In your office prepare a bigger glass beaker. Inside the beaker inject some butane (from the lighter refill). Cover the beaker, e.g. with a sheet of paper, and bring it into the class as if it was some really mysterious stuff.

T: I have brought a beaker. What do you think, does it contain anything?

P: The air.

T: May be but we are not interested in the air now. Think about it – is it possible that the beaker contains anything else? How can we find out?

Let them begin a discussion about the methods. Pupils can figure out interesting ways to find out what is inside. The idea to warm up the beaker will surely appear.

T: Yes, that would be possible, but it's better not to try. It will be quite enough to insert a burning skewer inside.

Do the experiment. It is going to be very surprising for the pupils.

Seminar for teachers – Experiment with butane

T: Now we can make a conclusion that something was inside the beaker. I will show you, how I put it there.

In front of the children inject a small amount of the butane inside the beaker again.

T: Can we pour this “something” into the other beaker? What do you think?

Check that there isn't butane in the second beaker with a burning skewer. Then pour the gas from one beaker to another. Prove that you have poured the gas with the skewer (it is necessary to check both beakers). Ask one of your students to repeat the experiment. (Be careful about pouring the gas out.) Point out that in the beginning the pupils have tried pouring water with closed eyes. Even though their eyes are open now, they still can't see what is being poured. In physics we often work with things that exist even though they cannot be seen.

### **Homework:**

At home try to ignite a candle from the biggest distance as possible. (Remind them to take care when working with fire.)

### **Continuation of this methodological sequence**

In the next lesson the teacher brings the same beaker filled with carbon dioxide. To pupils' surprise the burning skewer goes out. The teacher shows them how he filled the beaker and tells them what gas is inside. Then the pupils find out some properties of this gas and try to pour it into the other beaker. At the end of this sequence the teacher comes with the same beaker again and the students now say the burning skewer “doesn't do anything” (e.g. it continues to burn) inside it. The teacher discusses with pupils what gas could be there and then tells them that there is the air in the beaker. It is interesting to ask pupils why they spent so much time studying butane and carbon dioxide when those gases will not be used later and only the air will be examined. Pupils are usually able to say that air is common; it is interesting only in comparison with other gases which have different properties.

### **Conclusion**

We decided to show you a small part of the methodological sequence, which is used in the Heureka project, as an inspiration for your own teaching.

When presenting Heureka at conferences, we usually invite participants to visit our annual conference of the project – “The Heureka Workshops”. If you have a possibility to come at the beginning of October either this year or some following year, let us know. You are welcome. More information about the Heureka project can be found on our website [1].

The experience from the annual conference written by colleagues from Slovenia, Great Britain and USA is described in [2], [3] and [4].



“The Heureka Workshops 2010” – Presentation of the guest from Mexico.

### **References**

- [1] <http://kdf.mff.cuni.cz/heureka/en/>
- [2] Planinsic, G. (2006). Teachers share experiment know-how. *Physics Education* 41, No.1, 7-8
- [3] Swinbank, E. (2005). Reporting from a mattress in Nachod. *Physics Education* 40, No.1, p. 5
- [4] Milbrandt, R. (2010). Innovative Physics Teaching Conferences in the Czech Republic, *Physics Teacher* 48, September 2010, p. 395-396

## 4.3 Teaching about Energy. Which Concepts should be Taught at Which Educational Level?

**Paula R.L. Heron**

*Department of Physics, University of Washington, USA*

**Marisa Michelini**

*Physics Education Research Unit (PERU), University of Udine, Italy*

with the cooperation of Bat-Sheva Eylon *Weizmann Institute, Israel*, Yaron Lehavi, *The David Yellin College of Education, Israel* and Alberto Stefanel, *University of Udine, Italy*

### Participants

More than 30 colleagues participated to the Workshop offering an important contribution to the wide discussion. Here we report the names and the e-mail addresses, thanking the GIREP Committee for the decision to recognize a GIREP Thematic Group on *Energy Teaching and Learning*.

Pavlo Antonov <pavelantonovua@gmail.com>, Esther Bagno <esther.bagno@weizmann.ac.il>, Ugo Besson <ugo.besson@unipv.it>, bblondin@cesi.fr, Marina Castells <marina.castells@ub.edu>, Michele D'Anna <danna@liceolocarno.ch>, Maria José de Almeida <ze@fis.uc.pt>, Bat Sheva Eylon <Bat-sheva.Eylon@weizmann.ac.il>, Igal Galili <igal@vms.huji.ac.il>, Zofia Golab-Meyer <meyer@th.if.uj.edu.pl>, Paula Heron <pheron@phys.washington.edu>, Pedro Jorge <pedroj@lip.pt>, Dimitrios Koliopoulos <dkoliop@upatras.gr>, Yaron Lehavi <yarlehavi@gmail.com>, Olga Lendaltseva <oendalceva@yandex.ru>, Paul Logman <logman@uva.nl>, Mariani Cristina <crisrina.mariani@unimore.it>, mbu.danna@gmail.com, Michelini Marisa <marisa.michelini@uniud.it>, marisa.michelini@uniud.it, Ana Rita Mota <anaritalopesmota@gmail.com>, Valerie Munier <valerie.munier@montpellier.iufm.fr>, Nikos Papadouris <npapa@ucy.ac.cy>, Gesche Pospiech <gesche.pospiech@tu-dresden.de>, Joel Rosenberg <jrosenberg@berkeley.edu>, Lorenzo Santi <lorenzo.santi@uniud.it>, sassi elena <sassi@na.infn.it>, Alberto Stefanel <stefanel@libero.it>, Laurence Viennot <laurence.viennot@univ-paris-diderot.fr>

### Introduction

The learning and teaching of energy has been a rich field for research among students ranging in age from primary school through university. Many proposals for how to teach the subject have been guided by this research. In a Symposium at GIREP 2008 in Cyprus, several researchers presented findings with implications for teaching energy concepts. One outcome of the Symposium was the conclusion that no clear consensus exists on the structure of a vertically integrated curriculum for teaching energy. Such a curriculum would allow the coherent introduction of aspects of energy at appropriate ages and ensure continuity from year to year as children progress through the educational system. Some countries have devised national standards or guidelines that include recommendations for different aspects of energy at different grade levels. However in many cases these have not been guided by research. GIREP members are in a unique position to be able to make recommendations that are consistent with our knowledge of how students learn and the special conceptual challenges posed by the topic of energy. The goal of the Workshop was to make progress toward the challenge outlined above, specifically to make progress toward a unified, research-based view of which energy topics should be taught at which educational level. Before the workshop two contributions were sent by Dimitris Koliopoulos of *University of Patras, Greece* **Is it possible to teach energy in preschool and primary education?**, and Joel Rosenberg of *U.C. Berkeley, California, USA*, **Energy for Everyone**. These contributions became part of the work group activities: the relative abstracts are reported at the section CONTRIBUTIONS TO THE WORKSHOP of this report.

Another contribution for the Workshop discussion was offered by Bat-Sheva Eylon and Yaron Lehavi from Israel by means of an artifact for the discussion: **What has changed? - Energy as the language of changes**. The text of this contribution is presented after the abstracts mentioned above.

The Workshop activity was introduced by Marisa Michelini with an overview of the approaches to energy in research literature, a brief report on 2008 Energy Workshop held in GIREP Conference in Cyprus and a suggestion of problems to be considered for the WS discussion. Alberto Stefanel presented a research literature overview of the learning problems on energy concept. At the end of this report a single paper offers a critical analysis of the approaches and the learning problems in energy teaching/learning and a list of publications for an overview of research contributions.

Paula Heron discussed the main results of the Workshop emerging from the discussion organized in three big groups, working for about 90 minutes on teaching/learning energy in primary, low secondary and upper secondary school. In the following the report of Group responsible is presented. The position paper produced by the workshop activity is related as last part of this report.

## Discussion of Strand on Energy in Primary School

**Marisa Michelini**

*Physics Education Research Unit, University of Udine, Italy*

The discussion group on teaching / learning energy in the primary schools held in many a way, differentiated with respect to the competences and the experience possessed, and above all the way of looking at the problem. There were researchers presenting the problems on learning, on curricula, the authors with innovative curricular proposals in terms of new perspectives and the tools and methods used and teacher's trainers from different Universities and colleges and primary school teachers. The countries represented by the group were a good number of 11, all representatives aimed with a strong commitment for the development of science based education. The idea of addressing the Energy concept has been widely shared, starting from the primary school with the perspective of a vertical curriculum in which concepts related to this subject are gradually refined and completed.

In the first place, the conceptual problems related to learning energy were examined.

An extensive discussion was already held about on how to approach the concept of energy itself. Above all, the teachers requested and were looking for a suitable definition which could be adopted for primary school pupils, because later they may make a reference to anchor, with respect to the concepts. Many researchers are on the contrary oriented towards a gradual operative specification of the energy concept by means of an inquiry based learning activity. They proposed a gradually building the concept, in various specific ludic contexts in which it is operative.

The introduction of a way of thinking at the energy at local level had been widely considered as the correct way to proceed. It was underlined the effectiveness of learning to create a concept in specific situations and to strengthen the significance proposing the re-use in various situations. In this way, one can build both the intension and extension meanings of the concept of energy. Even more, it was shared the idea of proposing energy as a new language to discuss about the various phenomena (what happens) in comparison with the actions.

The discussion was held on how important it is to collect the ideas of pupils for organizing maps and posters in a large group discussion and then to be reorganized periodically with a deeper study. Emphasizing on this activity, how pupils look at different visions of Energy in: substances (gasoline, food, electrical charge), different entities (light, electricity), systems (sun, windmill), actions (movement) helps them to set forth the problem about the nature of energy. Similarly, the adjective forms of energy helps them to raise the question on how many forms and the types that synthesize and represent differ-

ent forms of energy. Thus, it follows the need to understand, like, what is the source of energy and in the relative processes to sense and then understand the day to day activities. Time was devoted to idea of comparison between the possible approaches to energy concept in primary. Some of the documents have been examined, like the NSTA on July 12, 2010, and some articles of the overview on research contributions presented (Michellini M. and Stefanel A., reported below) have been discussed. Not even a single common proposal was reached for implementation, but three possible approaches were discussed, considering both the positive and negative aspects. A qualitative approach based on energy chains has the advantage of understanding the energy as property which could be transformed and possessed in different forms in different systems. The awareness that, this is a property of the state of the system, is not likely to emerge in this context that maintains a vague idea about the nature of energy. The approach attributing an independent identity of energy and examines the processes in terms of energy flux could be useful to build the shift representations from a qualitative to a quantitative level.

The traditional approach that requires a path through the contents of force and work, conservative nature of the force, idea of gravitational potential and elastic energy, and the conservation of mechanical energy are among the most widely used in textbooks and also at low levels for the school pupils, and the teachers confirm conceptual confusion that results from both combined, with a lack of motivation to disorientation and inability to handle the concepts introduced. The approach to the industrial artifacts is motivating, but it reinforces all the ideas of common sense that one would like to overcome.

Also much had been discussed about the possibility of exceeding the qualitative level for the building of formal thought process. Some experimentations (Heron et al 2008) have had demonstrated the feasibility. At this scope, the points to be clarified are the nature of energy as the property and the state of the system, the identification of the transformation processes in the interactions and the associated idea of the source of the energy. The significant meaning of storage and dispersion of energy are the most common, everyday examples that come first, much before being transformed into complex industrial transformations. In order to discuss the conservation of energy being aware of their physics meaning, we need a system to be used as referent and in which we can identify the change in energy from time to time. To understand the differences between types and forms seems to be the most important among the other requirements to complete the interpretive framework and to reconstruct the language of common sense with scientific meanings. Addressing the description of energy from the most common experiences experienced is the most important suggestion for the curriculum in primary school and then in the first phase, the three processes: the energy of the food and from the food, the energy of motion and energy from the movement and then the energy from the warm bodies.

The richness of the problems faced and then the need to overcome those problems by means of an interaction and experience comparison led to a suggestion upon the request of a GIREP group on energy.

## **Discussion of Strand on Energy in Lower Secondary School**

**Bat-Sheva**

*Weizmann Institute, Israel*

**Eylon Yaron Lehavi**

*The David Yellin College of Education, Israel*

The group reacted to aspects related to energy standards presented in a recent standards document sent out for comments by NSTA (see appendix).

Members from different countries portrayed a similar picture concerning the prior knowledge on energy with which students arrive to secondary school. In their previous studies students learn that

there are different "types" or "forms" of energy; that energy can be "transformed" from one form to another and that energy can be "transferred" or "move" from one body to another. There is no doubt that this is a unique routine, un-paralleled with regard to other scientific concepts. Some members of the group claimed that the traditional ways of teaching about "types" or "forms" of energy in ages 10-14 stand in the way of developing meaningful understanding of the topic since students relate to energy types and transformations as "game of names".

Indeed research findings suggest that students have difficulties to comprehend the meaning of the concept of energy and the goal of providing a satisfactory functional conceptual understanding of energy is yet to be achieved (Duit, 1984; Goldring & Osborne, 1994; Solomon, 1992). It was suggested that a possible reason for this might be the lack of consensus within the physics education community as to the proper answer to the question what is energy (Papadouris et. al, 2008), whether there is a need to present a definition of energy to students and how.

The group discussed some difficulties to be addressed in teaching the concept of energy. The following table expands and organizes the discussed difficulties.

<b>Difficulties related to the definition (meaning) of energy</b>	<b>Difficulties related to the conservation of energy</b>	<b>PCK related questions</b>
<ul style="list-style-type: none"> <li>a. How can we distinguish its scientific content from its everyday meaning?</li> <li>b. How can we convince that it is one concept and not many?</li> <li>c. Why does it have forms (types)? How can we convince that these types are manifestation of the same entity and do not have different nature?</li> <li>d. How can we tell whether energy is conserved if we don't know what it is?</li> <li>e. How do we know that one form(s) of energy can be transformed into other form(s)? Is it a consequence of the law of energy conservation?</li> <li>f. How should we address the fact that energy has no absolute value?</li> <li>g. Can we measure energy or is it only an abstract concept?</li> <li>h. What is the meaning of the energy of a body (e.g. a chocolate bar?)</li> <li>i. How should we present heat and work?</li> <li>j. If energy is not a material entity, how can it move from one object to another?</li> </ul>	<ul style="list-style-type: none"> <li>a. Does it mean that energy cannot be created or destroyed? Why, then, do we have to stress that the law holds only in closed systems?</li> <li>b. How do we know that energy is conserved? Is it a consequence of the transformable nature of energy forms?</li> <li>c. Is it an empirically discovered law of nature or is it imposed on it by us?</li> <li>d. Can one, in principle, refute the law?</li> <li>e. If energy is conserved, what are energy sources?</li> </ul>	<ul style="list-style-type: none"> <li>a. What should be taught in each age?</li> <li>b. What cultural perspective should be considered?</li> <li>c. Should we avoid a definition of energy? Until what age?</li> <li>d. What kinds of representations should we adopt?</li> <li>e. How should we introduce the meaning of energy?</li> <li>f. What should be defined for students and what for teachers?</li> <li>g. How should we avoid misconceptions related to energy?</li> </ul>

Few approaches to address the question what is energy were mentioned in the discussion: (a) Providing no answer (in Richard Feynman words: "*It is important to realize that in physics today, we have no knowledge what energy is...*"); (b) The ability to do work (a mechanical definition); (c) The cause of events (Millar, 2000); (d) A definition based on an operational definition of energy change (Karplus, 1981); (e) Developing energy transfer and transformation as a theoretical framework that accounts for changes in very different systems (Papadouris et. al, 2008).

Members of the strand discussed pros and cons of the various approaches (Cf. the appended position paper about "**Energy as the language of changes**").

The group did not reach an agreement with regard to the question whether to define energy and what might be a proper approach for defining energy but stressed the need to continue the struggle to arrive at such an agreement.

## References

- Duit, R. (1984). Learning the energy concept in school - empirical results from the Philippines and West Germany. *Physics Education*, 19, 59–66.
- Goldring, H., & Osborne, J. (1994). Students' difficulties with energy and related concepts. *Physics Education*, 29, 26–32.
- Solomon, J. (1982). How children learn about energy - or: Does the first law come first? *School Science Review*, 63, 415–422.
- Papadouris, N., P. Constantinou, CP. (2008), Theodora Kyratsi, T., "Students' use of the energy model to account for changes in physical systems", *Journal of Research in Science Teaching*, 45(4), 444–469.
- Feynman, R. P. (1964). *Lectures on physics* (vol. I, pp. 4-1 – 4-8). Reading, MA: Addison-Wesley.
- Millar, R. (2000). Energy. In D. Sang (Ed.), *Teaching secondary physics* (pp. 1–43). London: John Murray.
- Karplus, R. (1981). Educational aspects of the structure of physics. *American Journal of Physics*, 49(3), 238–241.

## Appendix:

### **From Public Comment Draft released by NSTA on July 12, 2010**

#### Goals K-12 NSTA

1. Knowing, using, and interpreting scientific explanations of the natural world
2. Generating and evaluating scientific evidence and explanations
3. Understanding the nature and development of scientific knowledge;
4. Participating productively in scientific practices and discourse.

#### **Goals in Physical Science (PS2)**

Forces due to fundamental interactions underlie all matter, structures and transformations; balance or imbalance of forces determines stability and change within all systems. (Interactions, Stability, and Change)

*What happens when matter interacts or changes and how do we characterize, explain, and predict what will happen immediately and over time?*

#### Goals in Physical Science (PS3)

**PS3.A** *What is energy?* (Descriptions of Energy)

**PS3.B** *If energy is conserved, how can we use it? How do food and fuel give us energy?* (Energy for life and practical use: The special role of food and fuel)

**PS3.C** *Forces and energy transfer are both involved in changes of motion, how are they related?* (Relationship between Energy and Forces)

# Discussion of Strand on Energy in Upper Secondary School

**Alberto Stefanel**

*Physics Education Research Unit, University of Udine, Italy*

During the group discussion emerged the conviction that we need to introduce energy as quantity that can give a vision of the world alternative to the vision based on concept force.

The focus of the discussion was the main points to be included in a proposal for Upper Secondary School about energy. Here we resume briefly these points.

Energy is an abstract quantity associated to systems. The identification of the system is crucial speaking about energy, involving other crucial points: insulated/non-insulated system and association to systems of the potential energy; internal energy and change of energy through making work and heating (the processes to change the energy of a system).

Hint: energy is only defined up to an additive constant. What is defined is the variation of energy of a system. For this reason the focus must be on variation of energy and not simply on energy.

Energy is an extensive quantity. For this reason Energy can be thought as a material things flowing from one body to another. But heating is the process involving the flux of energy. A proposal on energy must face energy from this point of view and students must recognize what is involved from the conceptual point of view.

Energy is a state quantity, useful to describe state and processes and to develop a vision of the world alternative to the vision based, for instance, on force concept. A problem of the research is: how to introduce energy as unifying concept, not only in physics but also in all the other science curricula.

An approach to energy in Upper Secondary School must be quantitative and not only qualitative. About the definition of what energy is, for the majority of attendants it is impossible to define completely and exactly what energy is in Upper Secondary School. However, we can (for some students) open a window on energy, providing partial, modifiable and improvable definition of energy. For instance research problems are: how approaching energy in upper secondary school starting from a very partial, common in lower secondary school (and incorrect) definition as: “energy is the capacity to do work”; how to introduce energy taking into account the way in which energy is treated in other scientific disciplines courses?

Related to the previous point is: Energy as topic outside of the physics context. We need to propose a view on energy integrated and coherent in all the different scientific contexts.

The participants show consensus about approaches starting from kinetic energy. A phenomenological operative modality, following the Feynman style, was suggested as a practicable way to face energy in upper secondary school. Some critical positions were expressed about a purely phenomenological approach in Upper Secondary School (a mission impossible).

Such a proposal as the J. Ogborn’s one can constitute a referent, and a consensus on this point appeared: we need a very strong, research based proposal as to the methods of teaching/learning energy in upper secondary school, methods in which energy would be characterized following the peculiar meanings of such concepts as conservation, transformation and transfer. For instance, energy appears in different types transforming from one to another type, remaining at the same time constant in an insulated system and in general being conserved in the universe; momentum or angular momentum are conserved in insulated system in the same form and not only quantitatively. Moreover, energy is always involved in the processes with other quantities (momentum, electric current...), so students need to identify energy when they analyze a specific process, recognize how energy is involved in this process, distinguish the role of energy and the role of the other quantity. This point is related from one side to the question of energy carrier and from another side to the need of a deep critical analysis of the concept of transfer of energy, which can involve matter movement or wave movement. Another largely shared point was the inclusion in an approach to energy the treatment of degradation



and dissipation of energy. Two motivations supported this point: the knot of dissipation of energy is involved in everyday life processes and it is relevant concerning socio-economic issues; an energetic analysis of a process cannot give use instruments to establish the direction of evolution of the process, because we also need another quantity. If energy degradation must be included in the energy chapter on a strictly subject matter point of view remains an open question.

Last point treated was: Energy conservation is related to the space-time homogeneity (in particular when the H of a system is independent on time, energy is conserved). This aspect concerns a very deep structure of space-time. It must be included in a reconstruction of the subject. Is it possible to treat this point in a proposal for upper secondary school?

## **Contributions to the Workshop**

### ***Is it possible to teach energy in preschool and primary education?***

**Dimitris Koliopoulos**

*Department of Educational Sciences and Early Childhood Education, University of Patras, Greece*

We attempt to substantiate the idea that it is possible to teach ‘energy’ in preschool and primary education. For this purpose, we are referred to (a) the social demands and requirements related to energy education at the pre-school and low primary educational levels, (b) the nature and epistemological validity of the school knowledge to be introduced in the curriculum at the pre-school and low primary levels and (c) the possibility that young children have to construct a ‘precursor’ energy model utilizing a linear causal reasoning. We also present teaching activities addressed to 6-7 year old children which has been designed, realized and evaluated by members of the group ‘Energy in Education’ (<http://energyineducation.blogspot.com/>) which operates under the supervision of Department of Educational Sciences and Early Childhood Education of Patras University.

#### **References**

1. Koliopoulos, D., Christidou, V., Symidala, I. & Koutsoumba, M. (2009). Pre-energy reasoning in pre-school children. *Review of Science, Mathematics and ICT Education*, 3, 1, 123-140.
2. Koliopoulos, D. & Argyropoulou, M. (2010). Constructing qualitative energy concepts in an educational context with 6 – 7 year old students. [Submitted for review].

## **Energy for Everyone**

**Joel Rosenberg**

*Lawrence Hall of Science, U.C. Berkeley, California, USA - [jrosenberg@berkeley.edu](mailto:jrosenberg@berkeley.edu)*

We teach energy in all science disciplines, yet few American adults have a functional understanding of energy in their lives. Perhaps part of the problem is that we focus on science literacy for all [1], rather than what Ryder calls "functional science literacy" [2]. Ryder explains: "*Identifying subject matter knowledge to be taught by asking 'how might this knowledge be useful to the individual?' rather than 'what is the contemporary science view?' is likely to result in subject matter knowledge considered as misconceptions in current school science.*"

Engineering tends to be more functional, and so an introduction to thermodynamics that resembles more of an engineering model might be more useful to students. Towards that end, a macroscopic "alternate model" [3] to the traditional kinetic-molecular approach has been synthesized based on three curricula: the *Karlsruhe Physics Course* from Germany [4], *Energy and Change* from the UK [5], and *CASTLE* from the US [6]. The pros and cons of this synthesized model will be discussed, with the hope of becoming part of a larger discussion of how to teach this increasingly critical subject.

## References

- [1] American Association for the Advancement of Science (1990). *Science for All Americans*. New York: Oxford University Press.
- [2] Ryder, J. (2001). "Identifying Science Understanding for Functional Scientific Literacy." *Studies in Science Education*, 36, 1-44. Retrieved January 5, 2010, from <http://www.informaworld.com/smpp/content~content=a791786624&db=all>
- [3] Linn, M., diSessa, A., Pea, R., & Songer, N. (1994). "Can Research on Science Learning and Instruction Inform Standards for Science Education?" *Journal of Science Education and Technology*, 3, 7-15. Retrieved January 5, 2010, from <http://www.springerlink.com/index/M0V714W721T-5VW0K.pdf>
- [4] Herrmann, F. (2000). "The Karlsruhe Physics Course." *European Journal of Physics*, 21, 49-58. Retrieved January 5, 2010, from <http://www.ingentaconnect.com/content/iop/ejp/2000/00000021/00000001/art00308>
- [5] Boohan, R., & Ogborn, J. (1996). *Energy and Change*. Hatsfield: Association for Science Education.
- [6] Steinberg, M. & Wainwright, C. (1993). "Using Models to Teach Electricity — The CASTLE Project." *The Physics Teacher*, 31, 353-357. Retrieved January 5, 2010, from <http://dx.doi.org/10.1119/1.2343798>

## An artifact for the discussion. What has changed? - Energy as the language of changes

**Bat-Sheva Eylon, Yaron Lehavi**

*Weizmann Institute, Israel, The David Yellin College of Education, Israel*

Secondary school students arrive with prior knowledge from their studies on topics related to the concept of energy. They learned that there are different "types" or "forms" of energy; that energy can be transformed from one form to another and that energy can be "transferred" or "move" from one body to another. There is no doubt that this is a unique routine, un-paralleled with regard to other scientific concepts. But are there really different types of energy? What does it mean? What are the relationships between these types? What is meant by the expression that energy can be transferred between different bodies?

In order to address these questions, one should note that the concept of energy is used by us to describe various processes of change occurring in nature: a falling apple, a burning candle, light absorbed in a solar panel, the cooling of a hot cup of tea, etc. These processes are clearly very different from each other in terms of the factors and the systems they involve. Why, then, can we describe such processes by one concept? What is the common denominator for all the processes mentioned? In the past, until the famous experiment of Joule, it was not obvious that there is a connection between the different processes. While some seemed to share the ability to heat a body, others, like a body falling from a certain height or a change in a body's speed, seemed to posses

no such quality. Joule showed that the process of falling can lead to warming (of water) and thus motivated scientists to describe all the processes that can cause a change in temperature with one concept: "energy change". The term "energy change" appeared to be very successful in describing many processes, some of which, such as nuclear processes, absorption of infrared or ultra violet radiation, were unknown in Joule's times.

In order to avoid misunderstanding, one should note that the fact that a certain process *can* lead to warming, does not compel the latter to be the main result of this process (as, for example, when electrical charges flow through a bulb's filament). The main thing is to point at the common feature that *can* link between the different processes that occur in nature.

The term "energy change" is used by us to describe qualitatively and quantitatively a change in a system when it goes from one state to another. It is important to emphasize that the details of the process are not significant - only the difference between the different states matters. For example, an object's height relative to the Earth surface can change along a straight or a curved track (like in a roller coaster) but the size of the energy change, attributed to the change in height, will be determined by the difference between the initial and final states.

Is it possible to define energy? The famous physicist Richard Feynman wrote: *"It is important to realize that in physics today, we have no knowledge what energy is. We do not have a picture that energy comes in little blobs of a definite amount."* If this is the case, do we not try to reach too far in teaching the concept of energy? From what has been said so far, the quantity which can be measured, and thus defined operationally, is "energy change". Simply, energy change may be defined as follows: "energy change of a system is the measure of its change, during some processes, determined by the warming (or cooling) of a standard object." In a more free language we may define energy change as follows: "energy change is the ability to cause warming (or cooling)." Such a definition, as one may see from many examples, often addresses the daily experience of students regarding the various processes that occur in nature that can cause temperature change.

If there is only one concept, "energy change", why, then, do we have so much confusion with regard to the concept of energy? Why do we use many terms such as "types" or "forms" of energy, energy "transformation", energy "conversion" or "transfer" of energy?

Let us address first energy forms (or types): while "energy change" is one concept having no different types, the use of it in describing different types of processes generated the special jargon. Thus, it is due to the convenience of speech that we use different names for energy in order to remind ourselves the process that they describe:

- A change in kinetic energy refers to processes in which a body's speed varies;
- A change in potential (gravitational) energy refers to processes in which an object's height varies;
- Heat refers to processes in which a hot object interacts with a cold one and their temperature changes;
- A change in light energy refers to processes in which light is absorbed or emitted;
- A change in chemical energy refers to processes in which chemical composition of materials is changed;
- A change in electrical energy refers to processes in which the position of electric charges changes;
- A change in nuclear energy refers to processes in which nuclei change.

Despite the different names, one may easily trace back the common denominator for all processes: they could all be used by Joule to heat water. Importantly, not all the details of the various processes are accessible to our senses. For example, when we light a match we can clearly see how it changes but not the changes in the air around it; when a warm object comes into contact with a cold one only the change in each object's temperature is discernible but not the process of change occurring at their particulate level.

We saw that providing different names to energy change in describing different processes is intended to indicate the nature of those processes. But what do we mean by "conversion" of energy? If we examine carefully processes that occur around us, we may observe a very interesting phenomenon: the processes of change never occur alone! Any change is always accompanied by other change(s) and, moreover, the directions of the changes are opposite: if the value of the parameters of one (or

some) process of change tends to increase (or decrease) the tendency of others will be the opposite. For example, when an object falls, its decrease in height is always accompanied, simultaneously, by an increase in speed; When a candle burns, the wax (and the free oxygen around the candle) is consumed and, at the same time, the candle (and the air around it) is heated; When light is absorbed (and vanishes) by the solar heater panel the water is, simultaneously, heated.

This phenomenon of "simultaneous variations" can be described simply by specifying the fact that when the measure of one (or more) energy "type" decreases, that of other (or others) increases. However, this non-causal manner of speech did not take roots and, instead, the use of "energy conversion" took over meaning that the type of energy decreased is "converted" to the type of energy increased. One should be aware of the possible deficiency of such a routine of speech: it may imply that the nature of energy is changed. How should we measure a change in energy? A simple and direct way, following Joule, is to select a standard object (e.g. one gram of water) and decide that a change in temperature of one degree of this object constitutes the unit of measure of energy change.<sup>1</sup> This is how calorie was defined.

**Conservation of energy:** So far we avoided the quantitative aspects of energy change describing various processes occurring in nature. An intriguing question arises with regard to a system which does not interact with its environment (a closed system): does the energy decrease in various processes fully counterbalanced by the energy increase in the accompanying processes? Many experiments conducted so far showed that this is indeed the case: if we take into account all the changes taking place and measure quantitatively the energy changes attributed to each of them independently, we discover that "what goes up" is fully counterbalanced by "what goes down". Hence, the total energy change in a closed system adds up to zero. This is what we mean by energy conservation.

We may treat energy conversion between objects in a similar, non-causal, manner: it simply means that the energy change attributed to the process experienced by one object, is fully counterbalanced by the energy change attributed to the process experienced by the other object.

## Approaches and learning problems in energy teaching/learning: an overview

**Marisa Michelini, Alberto Stefanel**

*Physics Education Research Unit, University of Udine, Italy*

### The situation

A wide literature on Teaching/Learning (T/L) energy do not solve the problem, but focus on the main aspects of the problem for a reflection on how can be taught energy at different school and university levels and how students of different age learn this concept. This paper offers an overview on the literature to contribute to the discussion on a curricular proposal.

### Student conceptions.

About students' spontaneous ideas and conceptions a great effort was made in the last years of eighties and the first half of nineties (see for instance: Watts 1983; Duit, 1984; Lawson, McDermott 1987; Solomon 1983, 1992; Trumper, 1993; Watts, 1983; Duit, Haeussler 1994; Goldring, Osborne 1994; Driver Warrington 1995).

---

<sup>1</sup> Robert Karplus suggested a different method based on melting a standard ice cube.

Recently this line of research show a revival (Diakidoy, Iordanou 2003; Dawson-Tunik, Stein 2004, 2008; Yuenyong, Yuenyong 2007; Hirca et al. 2008; Mann, Treagust 2010).

Table 1 below summarize the different classifications about student and adults ideas of energy emerged: starting from Nicholls & Ogborn study (1993), where just 5 categories was found; then considering the summary of Trumper studies (1993), who carried out a cross-age study on energy concepts and where, exploring a large sample differentiating for age and school type evidenced a greater range of ideas, often age-related; finally considering the Dawson-Tunik extensive list, elaborated starting from the Trumper's one (Dawson-Tunik 2004, 2008).

Shared conclusions of these papers are the following. Many pupils associate energy only to specific systems (livings, battery, sources) or processes (movement, human activities, explosions, combustions), have difficulties in the association of energy to systems at rest and in particular in the recognition of potential and internal energy.

On the other side some pupils associate energy only to processes, not to a well identified systems, considering energy, according to the case, as a diffused quantity, quantity generated in the processes, or a sort of general fuel, or a fluid (imponderable, invisible) flowing from a body to another.

Students often fail to distinguish between energy and other physical quantities such as force or power.

Nicholls, Ogborn (1993)	Trumper (1993)	Dawson-Tunik, Stein (2004, 2008)
<ol style="list-style-type: none"> <li>1. Energy as human or animate activity;</li> <li>2. Energy as a fuel;</li> <li>3. Energy as movement;</li> <li>4. Energy as force;</li> <li>5. Energy as an invisible fluid.</li> </ol>	<ol style="list-style-type: none"> <li>1. Anthropocentric: energy is associated with human beings</li> <li>2a. Depository: some object have energy and expend it</li> <li>2b. Cause: energy as causing things to happen</li> <li>3. Ingredient: energy is a dormant ingredient within objects, released by a trigger</li> <li>4. Activity: energy is an obvious activity</li> <li>5. Product: energy is a product of some process or processes</li> <li>6. Functional: energy is seen as a very general kind of fuel associated with making life comfortable</li> <li>7a. Flow-transfer: energy is seen as a type of fluid transferred during some processes</li> <li>7b. The accepted scientific concept: 'When two systems interact [i.e., when a process take place], something, which we name energy, is transferred from one system to the other (Curriculum Develop. Center, Min. Of Educ. Israel)</li> </ol>	<ol style="list-style-type: none"> <li>1. Energy as a property of people or other living things;</li> <li>2. Energy as a fuel - electricity, petrol, calories in food, etc.;</li> <li>3. Energy as motion or activity;</li> <li>4. Energy as a force or power;</li> <li>5. Energy as a substance;</li> <li>6. Energy as something that causes things to happen;</li> <li>7. Energy as something that can be created;</li> <li>8. Energy as something that comes in different forms;</li> <li>9. Energy as something that can be transferred from one object to another;</li> <li>10. Energy as something that can be converted from one form to another</li> <li>11. Energy as a quantity that is conserved.</li> </ol>

**Table 1** - Idea of energy categories in three different papers. Common intersection of four categories emerge from comparison of the three lists. Each list is only partially the evolution of the previous one.

## Energy teaching approaches

Even if a shared view on ideas and conceptions of students concerning energy is found in literature, there is no consensus on the approach to be adopted and on the way to treat energy in the different school levels.

Four main approaches as concern T/L energy can be identified:

- 1) Energy forms and energy chain (Nuffield 1966; Kaper, Goedhart 2002; Hobson 2004) - In this approach energy is a conceptual idea; the focus is on transformation of energy; this approach is adopted mainly at low school level, where a qualitative idea of conservation of energy is given; the main learning problems are not treated and energy concept remains a vague idea.
- 2) A specific energy type as referent for a quantitative approach (PS2 1972). In PS2 approach all the energy forms are referred to the internal energy of a chosen system (i.e. a cylinder). Energy conservation assume the operative role of energy form identification, adopting a “what is changed” (quantitative) point of view. The need of a long path for the different energy types definition is the critical point of this approach in school.
- 3) Work-energy theorem way. This approach, that is the more traditional one (Loria, Michelini 1976; Halliday et al. 2001) follows the historical path of problems for physics development: forces, work, conservation of mechanical energy, kinetic energy theorem, thermodynamic principles. The basic goal is to discuss why we don't use only work and heat concepts, but we need to introduce a new quantity named energy (Lehrman 1973).
- 4) Energy carriers (Schmid 1982; Falk et al 1983; Herrmann 2000) - In this approach the focus is on the different quantities, that mediate energy transfer in the transformations. The main learning knots appear: why to introduce energy and not only the quantity carrying energy; the risk to materialize energy or the energy carrier (Strnad J 2000).

A wide discussion was engaged on primary and middle school (lower secondary) on whether and how energy should be taught (Millar 2000).

The main problems are:

- A) Construction of a meaningful idea for students (Warren 1986);
- B) Need of a vertical coherent path (Trumper 1996);
- C) Simplifications acceptable by physicists.

A critical point of view emerged against the forms of energy approach presented by Millar (2005), who also proposed a punctual critical discussion on how teaching energy at lower secondary school. In particular the main knots stressed are: the conservative character of energy, particularly important for the scientific conception of energy (Feynman 1963); the energy as an abstract property of systems; *Transfer versus transformation* (Else 1988); *Energy is not a cause* (Boohan and Ogborn, 1996).

For the college/undergraduate level, a critical analysis of energy concept and how it is taught was proposed by: Sherwood (1983), that suggested a general energy equation to avoid the introduction of differentiation between work and pseudo-work; Arons (1999), who stressed the need of a thermodynamic definition of work to treat frictional force or actions on or by deformable bodies; Jewed (2008), who analyzed in five parent papers, the work concept and the role of work-energy theorem, the difficulties in attributing energy (in particular potential energy) to a system when interacting with another system, the “incorrect usage” of words and concepts, the need for a “global” approach to energy including an energy/momentum approach avoiding concepts as pseudo-work or center-mass equation (Sherwood 1983).

## The main problems in teaching/learning energy

Starting from the analysis of the quoted papers, the main knots in teaching/learning energy are listed and discussed in the following.

- *Energy as capability to do work* - This is the more common identification of energy by students after a traditional teaching path. This partial definition is misleading and it is in contrast with thermodynamics: it doesn't work in the case of an *isocora* transformation and contrasts with thermodynamics laws (Arons 1999; Lehrman R 1973; Millar 2005; Sefton 2004). In addition, even if in a mechanic

perspective, as the work is made by a force, the “capability to do work” cannot be attributed to a single system. At low level it remains a slogan without any operative meaning in the large majority of everyday life situations (Duit 1984), but it is related to a bad recognition of the relationship between work and force (Portides 2007). In addition, its tautological nature (Lehrman R 1973; Sefton 2004) suggests that we do not need the energy concept, because work is enough.

- *Work and force relationship* - As it is shown in many researches (Gilbert, Watts 1983; Duit 1984; Trumper 1993; Dawson-Tunik 2005), students often identify the concepts of energy, work and force. The aforementioned critical reflections on the use of the concept of work and the theorem of kinetic energy in teaching (Arons 1999; Sefton 2004; Jewet 2008) stress the need for an educational reconstruction of contents, as already highlighted by McDermott et al. (1998).

- *Transformation and transfer of energy* - The concept of transformation from one type to another is one of the distinctive features of the energy concept, differentiating it from other physical conservative quantities, which remain always of the same form. For this reason the majority of the educational proposals on energy deal with this knot. The emphasis on energy transformations is particularly put in the approaches to the energy forms (Kaper, Goedhart 2002; Hobson 2004; Roeder 2002, 2003), sometimes identifying the concepts of energy transfer and energy transformation (Liu- Ruiz 2008). To differentiate themselves from these kind of approaches, some authors prefer use other expressions such as "energy conversion" (Duit 1984; McIldowie 1995; Singh, Rosengrant 2003; Meltzer 2004;) or “energy change” (Chisholm 1992; Legge, Petrolito 2004), or use the concept of “energy transformations” only to analyze simple experiments and situations referring to the transformation of types of energy introduced in physics: kinematic, potential, internal and transported by light (Driver, Warrington 1985; Heron et al. 2008, 2009; Van Heuvelen, Zou 2001). Else (1988) and Stylianidou, Ogborn (1999) suggest to replace the term transformation with transfer, because, in what are usually called energy transformations, there is in fact the passage of energy from one system to another. Although this position has become even in the national curriculum guidelines (Stylianidou, Ogborn 1999), most authors use the concepts of transformation and transfer (some time also transmission) and distinguish the two concepts. In particular, some have proposed a number of examples which show the need to use both concepts to characterize the energy (Arons 1999; Jewed 2008, Millar 2005). In these discussions it is not well clarified if energy transfer means that energy is a property transferred during the transformation or it is "Transferred from one system to another (from one place to another)" (Duit1984), involving the concept of propagation.

- *Which system? System (internal interactions) and isolated objects* - In the case of energy the identification of the system under observation is not as trivial as using other physics quantities. A debating point in literature is the attribution of potential energy to interacting systems: is it possible to attribute energy only to an insulated system? Is potential energy an energy associated in every case to an internal interaction? May we attribute potential energy to one of the two interacting subsystems (e.g. a body on the Earth surface)? (Arons 1999; Sefton 2004; Jewett 2008). A further related knots debated in the literature concern the need to present energy as distributed between the two interacting objects composing a system, as for instance a stone/rock and the Earth, rather than simply located with one single interacting object - as the stone in the example (McIldowie, 1995; Millar, 2000; Ross, 1993).

- *Storage of energy* - One of the main goal of an educational proposal on energy (Heron et al 2008, 2009) is to produce a scientific point of view as concerning the situation relative to expressions like: Storage of Energy; Dispersion/Consumption/Degradation of Energy. All of these expressions, usually used in the everyday life, evoke an idea of energy that contrasts with the scientific conception of energy as a property of a system, centered on its conservative nature (Schlichting, 1979; Solomon, 1982, 1992; Ogborn, 1990; Kesidou & Duit, 1993; Stylianidou, 1997).

- *Energy chain - representation* - A common approach to energy in primary and lower secondary school is a qualitative overview of energy chains to explain processes, machines and technological apparatuses functioning. This approach is related to the energy forms introduction almost as an useful intermediate step (Kaper, Goedhart, M. 2002; Hobson 2004). A criticism of this approach emerges from different subject related points of view and from learning difficulties of students (Schmid 1983, 1984; Ellen 1988; Heron et al 2008, 2009). In particular many authors agree that not all the so called energy forms are acceptable on the thermodynamic point of view (Millar 2005).

- *Constant or conservative?* - Energy is a typical conservative quantity (Feynman 1963; Millar 2005). Speaking of conservation we need to correctly consider the whole universe. Considering systems, under opportune condition, we must speak of energy as a constant quantity (Arons 1999; Jewett 2008). How to treat the conservation of energy at school is also a subject of discussion in literature, being not shared when and how to start to introduce the conservation of energy at school, and how is it possible to construct an effective functional understanding of the concept of conservation of energy (Duit 1984; Driver & Warrington, 1985; Solomon, 1992; Goldring & Osborne, 1994; Papadouri et al. 2008).

- *Internal energy* – One of the main knot in T/L Energy is how to treat internal energy giving students an idea of this concept close to the scientific one or almost improvable from a scientific point of view (Jewett 2008; Heron et al 2008).

### **Crucial aspects, nuclei and knots for a curricular planning**

From literature overview emerge the following list of crucial nuclei and conceptual knots to be considered for the curricular planning related to this concept.

- *Coherence in macro/micro analysis* - A deep analysis of this point is required from the educational reconstruction point of view for a coherent educational path.
- *Role of energy in interpreting changes in systems* - It is necessary to clarify that energy is not a *causal agent* in the evolution of a system and that the evolution of a system can be described without energy point of view. In addition there are processes in which the change into the system is not described in terms of energy change, as the free diffusion of an ideal gas.
- *Forms and types of energy* - Forms of energy evoked in everyday life are useful to identify local processes but create a lot of confusion from physics point of view; the following questions have to be considered: Are thermal, chemical, magnetic, nuclear... energy concepts necessary? What kind of need justify the introduction of different forms of energy in a teaching sequence? What is the meaning of source of energy? Can we teach/learn energy at low level using only kinetic energy, potential energy, internal energy and energy associated to e-m field? In this case, can we build a consistent discussion on energy also at low level? Have we to speak only and simply of energy (in vague terms)? What means in this case energy transformation?
- *Energy as unifying model between mechanics and thermodynamics* - An unifying vision of energy, including the mechanic and thermodynamic aspects, is the main goal in the curriculum in view of restituting the transversal and interdisciplinary role of the energy concept. How this perspective can be founded at primary level is the main challenge in the preparation and development of the energy concept in a precise and quantitative way.
- *Functional understanding of energy role vs quantitative conservation* - Approaching energy according to energy source/chain perspective is motivated by the functional role of energy concept in understanding apparatuses. Can such an approach shadow or hide the conservative nature of energy?

### **Concluding remarks**

The main problem is when and how to start teaching energy in school. A number of research approaches suggested the importance of addressing the concept of energy early in the school level, focalizing on the analysis of hands-on situation-problems to recognize energy transformations (Brook, Wells 1988; Carr, Kirkwood 1988). More recently a proposal for primary school is carried out building in



an operative way the concept of energy as an abstract quantity and language to describe phenomena, existing just in four basic types (kinetic, potential, internal, associated to light), able to transform itself from one type to another during interactions (Heron et al. 2008, 2009). The fertile idea recovered is the description of interactions with the energetic point of view, before the use of force concept (Golberg et al. 2010). Another proposal is to adopt a socio constructivist approach based on History and Philosophy of Science (Rizaki, Kokkotas 2009).

The role of energy in the social context and the language adopted by media concerning energy suggest to recover the introduction of energy forms (as nuclear, solar, aeolian, hydroelectric...), discussed extensively in classroom activities, including the first school level, where from this perspective the treatments often are not organic and coherent (Kirkwood, Carr 1989; Kruger 1990; Michinel Machado, Martinez D'Alessandro 1994; McIldowie 1995; Stylianidou et al. 2002; Diakidoy, Kendeou, Ioanides, 2003; Hobson 2004; EIA 2009).

Even if many authors agree that energy form language is not scientific and not all energy forms are acceptable from the thermodynamic point of view, some of them suggest to accept the use of the energy forms as an useful intermediate conceptual step (Kaper, Goedhart, M. 2002; Hobson 2004).

On the contrary a number of other authors underline that the introduction of energy forms is an unnecessary passage, producing mistakes and an incoherent conception of energy (Ellse, 1988; Millar 2005; Heron et al. 2008, 2009). This second point of view is also adopted by other authors stressing the importance to identify the energy fluxes and the idea of "energy carriers" (Falk et al. 1983; Schmid 1983, 1984; Hermann 2000). Energy flow diagram is the approach adopted to look at energy in relationship with the environmental phenomena (Hobson 2004).

The difficulties of middle school students in discussing concepts such as the degradation of energy or predicting, using energy, in what direction would evolve the phenomena, have directed the development of proposals in which energy is approached from the perspective of the II principle of thermodynamics (Schlichting 1979, Solomon, 1982, 1992; Ogborn, 1990; Kesidou & Duit, 1993; Stylianidou, 1997). This approach is, for example, at the base of the project "Energy and Change" (Boohan, Ogborn 1996) and is developed in a wide diffused proposal to introduce into the primary school the analysis in the context of the concept of energy (Duit 2004; Duit. et al. 2007).

Physics concept of energy to build the basic ideas on energy is the general point of view for the interdisciplinary perspective. A vertical curricular development of this concept requires to approach it in primary school avoiding misleading point of view. The research literature in physics education is producing suggestions in this direction. A bibliographic contribution to the problem is the list of papers we read, listed into the references below.

## References

- Arons A.B. (1999) Development of energy concepts in introductory physics course, *Am. J. Phys.* 67 (12), 1063-1067
- Black PJ, Ogborn JM (1977) The Nuffield A-level physics examination, *Physics Education*, 12/(2) 12-16
- Bliss. J. and Ogborn. J.(1985). Children's choices of uses of energy, *European Journal of Science Education*. 7. pp. 195-203
- Boohan, R and Ogborn, J (1996) Differences, energy and change: a simple approach through pictures. *School Science Review*, 78(283), 13-20.
- Boohan, R. (1996) 'Using a picture language to teach about processes of change' in Welford, G., Osborne, J. & Scott, P. (eds) *Research in Science Education in Europe* (The Falmer Press), 85-89.
- Borniole A., Colombo M., Michelini M., Santi L., Stefanel A. (2008) Exploring energy transformations and conservation for a curricular proposal in secondary school, in Constantinou C., *Physics Curriculum Design, Development and Validation*
- Brook, A. J. and Wells, P. (1988). Conserving the circus? An alternative approach to teaching and learning about energy. *Phys. Educ.* 23, 80-85.
- Carr, M. and Kirkwood, V. (1988) Teaching and learning about energy in New Zealand secondary school junior science classrooms. *Phys. Educ.* 23, 86-91.

- Chisholm, D. (1992). Some energetic thoughts. *Physics Education*, 27, 215–220.
- Colombo M., Michelini M., Stefanel A. (2008) Trasformazioni di energia: rivisitare il PS2 con l'on-line, *La Fisica nella Scuola*, XLI, 3 Suppl., 41-46
- Dawson, T.L. & Stein, Z. (2008). Cycles of research and application in education: Learning pathways for energy concepts. *Mind, Brain, and Education*, 2(2), 90-103.
- Dawson-Tunik, (2004) It Has Bounciness Inside! Developing Conceptions of Energy, <http://devtest-service.org/PDF/Bounciness.pdf>
- Diakidoy I.A. N., Iordanou K. (2003) Preservice teachers' and teachers' conceptions of energy and their ability to predict pupils' level of understanding, *European Journal of Psychology of Education*, 18 (4), 357-368
- Diakidoy I-A. N., Kendeou P., Ioannides C. (2003) Reading about energy: The effects of text structure in science learning and conceptual change, *Contemporary Educational Psychology*, 28, pp. 335–356
- Doménech J.L., Gil-Pérez D., Gras-Martí A., Guisasaola J. and Martínez-Torregrosa J., Salinas J., Trumper R., Valdés P., Vilches A. (2007) Teaching of Energy Issues: A Debate Proposal for a Global Reorientation, *Science & Education*, 16 (1) 43-64
- Driver, R., Warrington, L. (1985). Students' use of the principle of energy conservation in problem situations. *Physics Education*, 20, 171–176.
- Duit R. (2004) Schülervorstellungen und Lernen von Physik, PIKO-BRIEF NR. 1, <http://www.uni-kiel.de/piko/>
- Duit R., Mikelskis-Seifert S., Wodzinski C.T. (2007) *Physics in Context*, R. Pintò, D Couso eds., Springer: Berlin, 119-130.
- Duit, R. (1983). Energy conceptions held by students and consequences for science teaching. In H. Helm, Novak, J. D. (Ed.), *Proceedings of the International Seminar "Misconceptions in Science and Mathematics"* (pp. 316-321). Ithaca, N. Y.: Cornell University
- Duit, R. (1984). Learning the energy concept in school—empirical results from the Philippines and West Germany. *Physics Education*, 19, 59–66.
- Duit, R. (1987). Should energy be illustrated as something quasi-material? *International Journal of Science Education*, 9, 139–145.
- Duit, R., Haeussler, P. (1994). *Learning and teaching energy. The content of science*. P. Fensham, Gunstone, R., White, R. London, The Falmer Press: 185-200
- Ebenezer, J.V. & Fraser, D.M. (2001). First year chemical engineering students' conceptions of energy in solution processes: Phenomenographic categories for common knowledge construction. *Science Education*, 85, 509–535.
- EIA (2009) [http://www.eia.doe.gov/kids/energy.cfm?page=about\\_forms\\_of\\_energy-basics](http://www.eia.doe.gov/kids/energy.cfm?page=about_forms_of_energy-basics)
- Ellse, M. (1988). Transferring not transforming energy. *School Science Review*, 69 (248), 427-437.
- Falk, G., Herrmann, F., & Schmid, G.B. (1983). Energy forms or energy carriers? *American Journal of Physics*, 51, 1074–1077.
- Feynman, R. (1963). *The Feynman Lectures on Physics. Book 1*. New York: Addison-Wesley.
- Galili I., Goihbarg E. (2005) Energy transfer in electrical circuits: A qualitative account, *Am. J. Phys.* 73 (2), pp.141-144.
- Goldberg F., Otero V., Robinson S. (2010) Design principles for effective physics instruction: A case from physics and everyday thinking, *Am. J. Phys.* 78 (12) 1265-1277.
- Goldring, H., & Osborne, J. (1994). Students' difficulties with energy and related concepts. *Physics Education*, 29, 26–32.
- Halliday, Resnick, Walker (2001). *Fondamenti di fisica. Meccanica*. (Bologna: Zanichelli)
- Heron P, Michelini M, Stefanel A (2009) Teaching and learning the concept of energy at 14 years old, in *Frontiers in Science Education Research 2009 - FISER09*, selected contribution of the International conference on undergraduate science and mathematics education research, Famagusta 2009, Garip M. et al. Eds, Famagusta: E.M.U, p. 231-240
- Heron P, Michelini M., Stefanel A. (2009) Primary school teacher education on the concept of Energy, *ESERA Conf.*, Istanbul, 2009

- Heron P., Michelini M., Stefanel, A. (2010) Evaluating pedagogical content knowledge of energy of prospective teachers, Rogers L. et al., Community and Cooperation, GIREP-EPEC & PHEC Conference 2009 Selected Paper Book
- Heron P., Michelini M. (2008) Report of Symposium on energy, in Constantinou C., Physics Curriculum Design
- Heron P., Michelini M. and Stefanel A. (2008) Teaching & learning the concept of energy in primary school, in Constantinou C., Physics Curriculum Design.
- Herrmann F. (2000) The Karlsruhe physics course, *Eur. J. Phys.* **21** 49–58
- Hırça N., Çalik M., Akdeniz F. (2008) Investigating Grade 8 Students' Conceptions of 'Energy' and Related Concepts, *Journal of Turkish Science Education*, 5 (1) 75-87.
- Hobson A. (2004) Energy Flow Diagrams for Teaching Physics Concepts, *The Physics Teacher*, 42, pp. 113-117.
- Jewett J. W. (2008), Energy and the confused Student I: Work, *The Physics teacher*, 46 January 38-43; Energy and the confused Student II: Systems, *The Physics teacher*, 46 February 81-86; Energy and the confused Student III: Language, *The Physics teacher*, 46 March 149-153; Energy and the confused Student V I: a Global Approach to Energy, *The Physics teacher*, 46 April 210-217; Energy and the confused Student V: the Energy /Momentum Approach to Problem Involving Rotating and Deformable Systems, *The Physics Teacher*, 46 May, 269-274; Energy and the confused Student VI: Work, *The Physics teacher*, 46 January 38-43;
- Kaper, W. and Goedhart, M. (2002). 'Forms of energy', an intermediary language on the road to thermodynamics? Part I. *International Journal of Science Education*, 24 (1), 81-96. Part II. *International Journal of Science Education*, 24 (2), 119-138.
- Kirkwood V., Carr M. (1989) A valuable teaching approach:some insights from LISP (Energy), *Phys Educ.* 24, pp. 332-334.
- Kruger C. (1990) Some primary teachers' ideas about energy, *Phys Educ* 25, pp. 86-91.
- Lawson R. and McDermott L.C. (1987) Student understanding of the work-energy and impulse-momentum theorems *American Journal of Physics: Volume 55, Issue 9, Pages 811-817*
- Legge K. A. and Petrolito J. (2004) The use of models in problems of energy conservation, *Am. J. Phys.* 72 (4), pp. 436-438.
- Lehrman R. (1973) Energy is not the ability to do work, *Phys. Teach.* **11**, pp. 15-18.
- Liu X, Ruiz M.E. (2008) Using Data Mining to Predict K–12 Students' Performance on Large-Scale Assessment Items Related to Energy, *Journal Of Research In Science Teaching*, 45 (5) pp. 554–573
- Loria A., Michelini M. (1976). Termodinamica al primo anno di fisica. *Giornale di Fisica*, vol 2, 4, pag 71
- Michael Machado J.L., Martinez D'alessandro A.(1994) El concepto de energía en los libros de textos, *Enseñanza de las ciencias*, 12 (3).pp. 369-380.
- O'Brien Pride T, Vokos S, McDermott L.C. (1998) The challenge of matching learning assessments to teaching goals: An example from the work-energy and impulse-momentum theorems, *Am. J. Phys.*, 66 (2), pp. 147-157.
- Mak, S-Y. and Young, K. (1987). Misconceptions in the teaching of heat, *School Science Review*, 68 (244), 464-470.
- Mann M., Treagust D. F. (2010) Students' conceptions about energy and the human body, *Science Education International*, 21 (3), pp. 144-159.
- McIldowie E. (1995) Energy transfer-where did we go wrong?, *Phys. Educ.* (30) 228-230.
- Meltzer D. E. (2004) Investigation of students' reasoning regarding heat, work, and the first law of thermodynamics in an introductory calculus-based general physics course, *Am. J. Phys.* 72 (11), pp. 1432-1446.
- Millar, R. (2005). Teaching about energy. Department of Educational Studies Research Paper 2005/11. York University
- Millar, R. (2000) Energy. In D. Sang (ed.) *Teaching secondary physics* (pp. 1-43). London: John Murray.
- Mungan C.A. (2005) A Primer on Work-Energy Relationships for Introductory Physics, *The Physics Teacher* (43) pp. 10-16

- Nicholls, G., & Ogborn, J. (1993) Dimensions of children's conceptions of energy. *International JISE*, 15(1), 73-81
- Nuffield (1966) *Physics Teachers' Guide I* (London: Longmans/Penguin)
- Ogborn J and Whitehouse M 2000 (eds) *Advancing Physics AS* (Bristol: Institute of Physics Publishing)
- Ogborn J and Whitehouse M 2001 (eds) *Advancing Physics A2* (Bristol: Institute of Physics Publishing)
- Ogborn, J. (1986). Energy and fuel: The meaning of the go of things. *School Science Review*, 68, 30–35.
- Ogborn, J. (1990). Energy, change, difference and change. *School Science Review*, 72, 81–85.
- Papadouris N.,Constantinou C.P., Kyratsi T. (2008) Students' Use of the Energy Model to Account for Changes in Physical Systems, *Journal of Research in Science Teaching* Vol. 45, No. 4, PP. 444–469
- Portides, D.P. (2007). The relation between idealization and approximation in scientific model construction. *Science and Education*, 16(7-8), 699-724.
- PP(2004) *Practical Physics*, accessible at <http://www.practicalphysics.org>
- PS2 (1972) *Physical Science II*, Prentice-Hall: Inc Englewood Cliffs
- Rizaki A., Kokkotas P. (2009) The Use of History and Philosophy of Science as a Core for a Socioconstructivist Teaching Approach of the Concept of Energy in Primary Education, *Science & Education*, Online publication date: 5-Dec-2009.
- Roeder J. L. (2002) *Active Physics* Chapters on Energy, *AAPT Announcer*, 32(2), 95 (Summer 2002)
- Roeder J. L. (2003) **Energy - a Basic Physics Concept and a Social Value**, at <http://www.aps.org/units/fed/newsletters/fall2003/RoederEnergy.html>
- Ross, K. (1988). Matter scatter and energy anarchy. The second law of thermodynamics is simply common experience. *School Science Review*, 69 (248), 438-445.
- Ross, K. (1993). There is no energy in food and fuels - but they do have fuel value. *School Science Review*, 75 (271), 39-47.
- Schlichting H.J. (1979) Energy and Energy Waste: a Topic for Science Education, *International Journal of Science Education*, 1 (2) pp. 157 – 168.
- Schmid (1982) Energy and its carrier, *Phys. Educ.*, 17, pp. 212-218
- Sefton I.M. (2004) Understanding Energy, *Proceedings of 11th Biennial Science Teachers' Workshop*, June 17 and 18, 2004, The University of Sydney, [http://sydney.edu.au/science/uniserve\\_science/school/curric/stage6/phys/stw2004/sefton1.pdf](http://sydney.edu.au/science/uniserve_science/school/curric/stage6/phys/stw2004/sefton1.pdf)
- Sherwood B.A. (1983) Work and Pseudo-work, *AJP*, 51 (7), 597-602
- Singh C., Rosengrant D. (2003) Multiple-choice test of energy and momentum concepts, *Am. J. Phys.* 71 (6) 607-617
- Solbes J., Guisasola J., Tarín F. (2009) Teaching Energy Conservation as a Unifying Principle in Physics, *Journal of Science Education and Technology*, 18 (3) 265-274
- Solomon, J. (1982). How children learn about energy, or Does the first law come first? *School Science Review*, 63 (224), 415-422.
- Solomon, J. (1983). Messy, contradictory and obstinately persistent: a study on children's outof-school ideas about energy. *School Science Review*, 65, 225–229.
- Solomon, J. (1992). *Getting to know about energy in school and society*. London: Falmer Press.
- Stylianidou, F. (1997). Children's learning about energy and processes of change. *School Science Review*, 79, 91–97.
- Stylianidou, F. and Ogborn, J. (1999) 'Teaching about energy in secondary schools: teachers' transformations of a curriculum innovation', *Second International Conference of ESERA on 'Research in Science Education: Past, Present, and Future'*, Kiel, Germany, August 31 - September 4, 1999, at <http://www.ipn.uni-kiel.de/projekte/esera/book/paraf.htm>
- Stylianidou, F. and Ogborn, J. (1999) 'Teaching about energy in secondary schools: The case of two innovations and teachers' transformations of them'. In Komorek, M., Behrendt, H., Dahncke, H., Duit, R., Gräber, W., Kross, A. (Eds) *Proceedings of the Second International Conference of ESERA on 'Research in Science Education: Past, Present, and Future'*, Kiel, Vol.2, pp 450-453. (<http://www.ipn.uni-kiel.de/projekte/esera/book/s057+sty.pdf>)

- Stylianidou F., Ormerod F., Ogborn J. (2002) Analysis of Science Textbook Pictures about 'Energy' and Pupils' Readings of Them, *International Journal of Science Education*, 24 (3), pp. 257-283.
- Strnad J 2000 On the Karlsruhe physics course *Eur. J. Phys.* **21** L33–36
- Trumper, R. (1990). Energy and a constructivist way of teaching. *Physics Education*, 25, 208–212.
- Trumper, R. (1993). Children's energy concepts: A cross-age study. *International Journal of Science Education*, 15, 139–148.
- Trumper, R. (1997). A survey of conceptions of energy of Israeli preservice high school biology teachers. *International Journal of Science Education*, 19(1), 31–46
- Van Heuvelen A, Zou X (2001) Multiple representations of work–energy processes, *Am. J. Phys.*, 69 (2) pp. 184-194
- Warren, J.W. (1982). The nature of energy. *European Journal of Science Education*, 4 (3), 295-297.
- Warren, J.W. (1983). Energy and its carriers: Acritical analysis. *Physics Education*, 18, 209–212.
- Warren, J.W. (1986). At what stage should energy be taught? *Physics Education*, 21, 154–156.
- Warren, J.W. (1991). The teaching of energy. *Physics Education*, 26 (1), 8-9.
- Watts, D.M. (1983). Some alternative views of energy. *Physics Education*, 18, 213–217.
- Watts, D.M., Gilbert, J. K. (1983). Appraising the understanding of science concepts: "Energy". Guildford: Educational Studies
- Welch, W. W. (1984). Learning about energy: A review of the literature. Science Education Research Unit, University of Waikato, Hamilton, N. Z.
- Yuenyong C., Yuenyong J (2007) Grade 1 to 6 Thai Students' Existing Ideas about Energy, *Science Education International*, 18 (4), 289-298
- Yuenyong, C., Jones, A., & Yutakom, N. (2008). A comparison of Thailand and New Zealand students' ideas about energy related to technological and societal issues. *International Journal of Science and Mathematics Education*, 6(2), 293-311.

# Position paper: Energy as the language of changes<sup>1</sup>

Research findings suggest that the goal of providing a satisfactory functional conceptual understanding of energy is yet to be achieved (Duit, 1984; Goldring & Osborne, 1994; Solomon, 1992). A possible reason for this might be the lack of consensus within physics education as to the proper answer to the question what is energy, considered to be of fundamental importance (Papadouris et. al, 2008). The following are few approaches to address the question:

- (a) Providing no answer (in Richard Feynman words: "*It is important to realize that in physics today, we have no knowledge what energy is...*");
- (b) The ability to do work (a mechanical definition);
- (c) The cause of events (Millar, 2000);
- (d) A definition based on an operational definition of energy change (Karplus, 1981);
- (e) Developing energy transfer and transformation as a theoretical framework that accounts for changes in very different systems (Papadouris et. al, 2008).

The first two approaches seem to provide no, or incomplete, answer to the question what is energy. Approach (c) may limit the necessity to use energy at all since differences in physical quantities may suggest alternative explanations for changes to happen (Ogborn, 1986).

The last two approaches (d) & (e) require some elaboration. They seem to complement each other but differ epistemologically: the former employs an operational definition of *energy change*, which can be attributed to Joule's experiments (Robert Karplus suggested melting a standard ice cube), while the latter presents energy as an abstract, trans-phenomenological, concept. Approach (d) emphasizes the fact that only differences in energy are of physical significance and can be measured (Reif, 1967, p. 202; Reif, 1965, p. 129). The term "energy change" is thus used to describe qualitatively and quantitatively a change in a system when it goes from one state to another. The details of the process are not significant - only the difference between the different states.

It was suggested that the above mentioned approaches (d) and (e) might address these difficulties. According to these approaches the concept of energy is used in describing various processes of change occurring in nature: a falling apple, a burning candle, light absorbed in a solar panel, the cooling of a hot cup of tea etc. These processes are clearly very different from each other in terms of the factors and the systems they involve and it is not apparent why they can be described by one concept. Approach (d) suggests that the common denominator for many processes may rest on how one can evaluate process of change by measurement. In the past, until the famous experiment of Joule, it was not obvious that there is a connection between such different processes. While some seemed to share the ability to heat a body, others, like a body falling from a certain height or a change in a body's speed, seemed to possess no such quality. Joule showed that the process of falling can lead to warming (of water) and thus motivated scientists to describe all the processes that can cause a change in temperature with one concept: "energy change". The term energy change appeared to be very successful in describing many processes, some of which, such as nuclear processes, absorption of infrared or ultra violet radiation, were unknown in Joule's times<sup>2</sup>.

---

<sup>1</sup> This paper, written by Bat-Sheva Eylon and Yaron Lehavi, presents the main ideas developed during the Workshop on *Teaching about energy. Which concepts should be taught at which educational level?* organized by Paula R.L. Heron and Marisa Michelini, with the cooperation of Bat-Sheva Eylon, Yaron Lehavi and Alberto Stefanelli in 2010 Reims GIREP Conference.

<sup>2</sup> In order to avoid misunderstanding, one should note that the fact that a certain process can lead to warming, does not compel the latter to be the main result of this process (as, for example, when electrical charges flow through a bulb's filament). The main thing is to point at the common feature that can link different processes that occur in nature.

Energy change of a system may thus be defined as the measure of its change, during some processes, determined by the warming (or cooling) of a standard object. In a more free language we may define energy change as follows: "energy change is the ability to cause warming (or cooling)." Such a definition, as one may see from many examples, often addresses the daily experience of students regarding the various processes that can cause temperature change. The definition of energy follows the definition of energy change through observation: one should observe which parameter (e.g. speed, height, temperature etc.) can be used to describe the difference between the initial and the final states of a particular system and relate the energy change to the difference in this parameter. Such a relation, as found experimentally, is not necessarily linear.

The one concept, determined without any ambiguity, "energy change", can be used to clarify the meaning of such terms as "types" or "forms" of energy, energy "transformation", energy "conversion" or "transfer" of energy. The use of energy change in describing *different types of processes* might be the reason for generating the special jargon. Thus, it is due to the convenience of speech that we use different names for energy: kinetic, potential, chemical, nuclear etc. They remind one the process that they describe and its nature.

Despite the different names, one may easily trace back the common denominator for all the above mentioned processes: they could all be used by Joule to heat water. Importantly, not all the details of the various processes are accessible to our senses. For example, when we light a match we can clearly see how it changes but not the changes in the air around it; when a warm object comes into contact with a cold one only the change in each object's temperature is discernible but not the process of change occurring at their microscopic level.

Energy conversion, or transformation, is also used for convenience. If one examines carefully processes in nature, one may observe a very interesting phenomenon: any change is always accompanied by other change(s) and, moreover, the directions of the changes are opposite: if the value of the parameters of one (or some) process of change increase (or decrease) the tendency of others will be the opposite. For example, when an object falls, its decrease in height is always accompanied, simultaneously, by an increase in speed; When a candle burns, the wax (and the free oxygen around the candle) is consumed and, at the same time, the candle (and the air around it) is heated; When light is absorbed (and vanishes) at the solar heater panel the water is, simultaneously, heated.

This phenomenon of "simultaneous variations" can be described simply by specifying the fact that when the measure of one (or more) energy "type" decreases, that of other (or others) increases. However, this non-causal manner of speech did not take roots and, instead, the use of "energy conversion" took over, meaning that the type of energy decreased is "converted" to the type of energy increased. One should be aware of the possible deficiency of such a routine of speech: it may imply that the nature of energy is changed.

Conservation of energy may also be deduced from the measured concept of energy change. Many experiments conducted so far show that if one considers all the changes in a system which does not interact with its environment (a closed system) and measures the energy changes attributed to each of them independently one finds, experimentally, that the energy decrease in various processes is fully counterbalanced by the energy increase in the accompanying processes. Hence, the total energy change in a closed system adds up to zero.

## References

- Duit, R. (1984). Learning the energy concept in school - empirical results from the Philippines and West Germany. *Physics Education*, 19, 59–66.
- Goldring, H., & Osborne, J. (1994). Students' difficulties with energy and related concepts. *Physics Education*, 29, 26–32.
- Solomon, J. (1982). How children learn about energy - or: Does the first law come first? *School Science Review*, 63, 415–422.
- Papadouris, N., Constantinou, C. P., & Kyratsi, T. (2008). Students' use of the energy model to account for changes in physical systems. *Journal of Research in Science Teaching*, 45(4), 444–469.

- Feynman, R. P. (1964). *Lectures on physics* (vol. I, pp. 4-1–4-8). Reading, MA: Addison-Wesley.
- Millar, R. (2000). Energy. In D. Sang (Ed.), *Teaching secondary physics* (pp. 1–43). London: John Murray.
- Karplus, R. (1981). Educational aspects of the structure of physics. *American Journal of Physics*, 49(3), 238–241.
- Ogborn, J. (1986). Energy and fuel: The meaning of the go of things. *School Science Review*, 68, 30–35.
- Reif, F., *Fundamentals of Statistical and Thermal Physics* (McGraw-Hill, 1965)
- Reif, F., *Statistical Physics* (McGraw-Hill, 1965)



# Chapter 5

---

Complementary aspects

# An instrument for measuring self-efficacy beliefs of Secondary school physics teachers in Brazil

Marcelo Alves Barros  
*Institute of Physics of São Carlos, University of São Paulo, Brazil*  
mbarros@ifsc.usp.br

Carlos Eduardo Laburú  
*Department of Physics, State University of Londrina, Brazil*  
laburu@uel.br

Fábio Ramos da Silva  
*Federal University of Mato Grosso, Brazil*  
fabioramos@ufmt.br

## 1 INTRODUCTION

The influence of self-efficacy beliefs of students and teachers on motivational and self-regulation processes has been the interest of several researchers in the field of Science Education (Smollich and Yoder, 2008; Palmer, 2006; Britner and Pajares, 2006; Katelhut, 2007; Zusho *et. al*, 2003; Ginns *et. al*, 1995; Riggs and Enochs, 1990).

By the same token, recent studies in contemporary psychology about motivation in the school context have also demonstrated the growing interest of researchers in the teachers' beliefs (Schunk, 1991; Pajares, 1992; Pintrich *et. al*, 1993 etc.). The attention of these researchers has turned to the processes that take place in the classroom, with an emphasis on self-regulation in the learning process and the identification of the differences among teachers with respect to their knowledge of the subject and their beliefs about teaching and learning, self-efficacy beliefs being one of the most important educational beliefs of the teachers.

This work presents the validation results of a data collection instrument, specifically dedicated to study the self-efficacy beliefs of Secondary School Physics Teachers in Brazil. It is worth noting the efficacy belief in teaching (Woolfolk & Roy, 1990) as particularly interesting because it represents a teaching belief in a particular discipline, assuming no personal involvement in such assessment. Our instrument covers both levels: the Personal Efficacy Belief of Physics Teachers (or Teacher's Self-efficacy) and the General Efficacy Beliefs in Physics Teaching.

The importance of this study is justified by the lack of research in the area selected to investigate these motivational beliefs with Physics teachers, although there are study results with teachers of other subjects and within many contexts.

## 2 RESEARCH METHODOLOGY AND DATA COLLECTION

The methodology of our investigation is of quantitative nature with correlational design. The data were collected from 136 Secondary School Physics Teachers in Brazil. The instrument used for collecting the data was closed questionnaire with Likert-scale standard answers with 34 items about self-efficacy beliefs of the investigated teachers. Of these 34 items, half refers to what we term as **Personal Efficacy Belief of Physics Teachers**, a term that was adopted in analogy to the belief of self-efficacy teaching (Woolfolk and Roy, 1990). The remaining items refer to the **General Efficacy Belief in Physics Teaching**, a term similar to the efficacy belief in Education (*idem*). Objective questions were also made to collect additional information to supplement our data as: the teacher's age, length of experience, gender, graduation courses, specialization, master's and doctorate. To carry this

test out we have used the statistical software package SPSS<sup>®</sup> 13 (*Statistical Package for the Social Sciences for Windows*).

For the elaboration of the instrument related to Physics Teaching, we began by adapting two existing instruments developed with the same theoretical assumptions; the instrument developed by Woolfolk & Roy (1990) and the original version of STEBI-A (Science Teaching Beliefs Instrument), developed by Riggs & Enochs (1990).

The adaptation of these instruments was necessary given that both presented very general issues, where the first case refers to Education in general and the second case refers particularly to Science Teaching. Thus, we sought to reformulate some items and develop other aspects that corresponded with aspects of Physics Teaching, such as questions relating to specific aspects of this subject, for instance: the experimentation, conceptual structure and formalism mathematics.

### 3 RESULTS AND DISCUSSION

The content validation analyzes the wording in the items of the instrument, both semantics as well as epistemological. Accordingly, the items were carefully analyzed by three experienced researchers in education. One of the experts evaluated the items comprising the questionnaire. We conducted the process of criteria validation and construct validation.

For the first stage of the construct validation, we conducted two tests for all items of the questionnaire, the item-total correlation test and the reliability coefficient test or Cronbach's Alpha. As a cut-off values criterion for the test results of item-total correlation, we eliminated all the items that had a correlation index of less than 0.20. This resulted in the exclusion of eight items for General Efficacy Belief in Physics Teaching and six for Personal Efficacy Belief of Physics Teachers.

We found the value of 0.61 for the Cronbach's Alpha regarding the General Efficacy Beliefs in Physics Teaching, and 0.79 for the items that correspond to the Personal Efficacy Belief of Physics Teachers. The Table 01 shows the items that are considered for the analysis of **General Efficacy Belief in Physics Teaching**.

<b>Items regarding the General Efficacy Belief in Physics Teaching</b>	<b>Corrected item-total Correlation</b>	<b>Cronbach's Alpha if the item is excluded</b>
The teachers consider the physical concepts accessible to all students.	0.216	0.601
The teachers believe that the physical concepts are too abstract and barely understood by students.	0.298	0.580
The teachers believe that a student who has difficulties in mathematics will not be interested in physics.	0.237	0.600
The problem of the student's motivation to learn physics resides in the student.	0.273	0.587
When a student's scores in physics improve, it is often due to the teacher who found more effective teaching strategies.	0.209	0.599
A student's learning difficulty in physics can be overcome by a good teacher.	0.380	0.563
A student's low performance in physics is not the teacher's responsibility.	0.304	0.578
A teacher's significant effort to teach	0.355	0.566

physics produces little change in students' performance.

The students' performance in physics is directly related to the effectiveness of their teacher in teaching. 0.411 0.548

Table 01 – Correlation item-total and Cronbach's alpha for General Efficacy Belief in Physics Teaching items.

The Table 02 shows the items that are considered for the analysis of **General Efficacy Belief in Physics Teaching**.

Items referent to the Personal Efficacy Belief of Physics Teachers	Correlation item-total corrected	Cronbach's Alpha if the item is excluded
I feel capable of making the physical concepts accessible to all students.	0.333	0.788
I feel capable of implementing experimental activities in my teaching.	0.477	0.773
I can join my academic background and my ability to motivate students during Physics class.	0.410	0.781
I believe I am able to motivate my students during Physics class.	0.313	0.788
I continually find better ways to teach Physics to my students.	0.405	0.780
I am not very effective in developing experimental activities.	0.489	0.772
I do not feel capable to teach Physics to my students.	0.378	0.785
I encounter difficulties in explaining to students how the Physics experiments work.	0.665	0.747
I am always able to respond questions from students about Physics.	0.415	0.782
I know that I possess the necessary skills to teach Physics to students.	0.552	0.767
When a student has trouble understanding a Physics concept, I usually know how to help him to better understand it better.	0.558	0.767

Table 02 – Correlation item-total and Cronbach's alpha for Personal Efficacy Belief of Physics Teachers items.

Finally, our data was subjected to an exploratory factorial analysis by the extraction method of the main components with equamax rotation and Kaiser Normalization (Dancey and Reidy, 2006). As the concern was to investigate the contribution of the 23 items for the two constructs studied (Personal Efficacy Belief of Physics Teachers and General Efficacy Belief in Physics Teaching), we only considered the two factors with more variance explanation. The results of the KMO test and Bartlett sphericity, which are necessary to

implement such analysis, were satisfactory (KMO = 0.71 and Bartlett = 0.0001). Table 03 illustrates the factorial analysis results:

	Personal Efficacy Belief of Physics Teachers	General Efficacy Belief in Physics Teaching
I encounter difficulties in explaining to students how the physics experiments work.	<b>0.785</b>	-0.054
When a student has trouble understanding a Physics concept, I usually know how to help him understand it better.	<b>0.708</b>	0.016
I know that I have the necessary skills to teach Physics to students.	<b>0.681</b>	0.126
I am not very effective in developing experimental activities.	<b>0.667</b>	-0.104
I feel capable to implement experimental activities in my teaching.	<b>0.614</b>	-0.112
I am always able to respond questions from students about Physics.	<b>0.532</b>	0.252
I continually find better ways to teach Physics to my students.	<b>0.531</b>	0.086
I am able to join my academic background and my ability to motivate students during Physics class.	<b>0.487</b>	0.175
I do not feel capable to teach Physics to my students.	<b>0.472</b>	0.129
The students' performance in Physics is directly related to their teacher's effectiveness in teaching.	0.144	<b>0.653</b>
The learning difficulty of a Physics student can be overcome by a good teacher.	0.136	<b>0.614</b>
A student's low performance in physics is not the teacher's responsibility.	-0.126	<b>0.560</b>
A teacher's major effort to teach physics produces little change in students' performance.	0.028	<b>0.503</b>
The student's motivation problem in learning physics is within the very student.	-0.137	<b>0.467</b>
When Physics students' grades improve, it is often due to the teacher who found more effective teaching strategies.	0.193	<b>0.422</b>
Teachers believe that the physical concepts are very abstract and hardly understood by students.	0.012	<b>0.414</b>
Teachers consider that the physical concepts are accessible to all students.	0.161	<b>0.387</b>
Teachers believe that a student who has difficulties in mathematics is not interested in physics.	0.039	<b>0.324</b>

Extraction method: Analysis of the main components.  
 Rotation method: Equamax with Kaiser Normalization.  
 The rotation converged on 3 iterations.

Table 03 - Factorial Analysis for Personal Efficacy Belief of Physics Teachers and General Efficacy Belief in Physics Teaching items.

The items: “*I feel capable of making the physical concepts accessible to all students*” and “*I believe I am able to motivate my students during Physics class*”, were excluded because they had significant factorial loads in two factors. We consider significant loads those that were greater than 0.30 (Hair, et. al, 2005). The new values for the reliability coefficient were 0.61 for General Efficacy Belief in Physics Teaching and 0.78 for Personal Efficacy Belief of Physics Teachers.

#### 4 CONCLUSIONS AND IMPLICATIONS

This work presented some procedures used to study the validity of an instrument on self-efficacy beliefs of Secondary School Physics Teachers in Brazil. The results for our instrument agree with other studies in this line of research.

We chose the non-parametric testing, that is, tests not needing a set of data that has a normal distribution and does not assume prior knowledge of the sample’s population origin. The use of parametric tests must be unique to the case of actual numerical variable analysis, in order to not cause data distortion and generate doubts about the validity of the drawn conclusions based on evidence.

We found the approximate value of 0.248 for the predictive correlation between total scores of General Efficacy Belief in Physics Teaching and Personal Efficacy Belief of Physics Teachers. Similar results were found by Riggs and Enochs (1990) with significant correlations of 0.46 and 0.19, respectively.

Regarding the internal consistency of the instrument, we found similar results in studies conducted with a similar methodology and theoretical foundation as this work, in which Cronbach's alpha for the Personal Efficacy Belief of Physics Teachers was significantly higher than the coefficient for General Efficacy Beliefs in Physics Teaching (Palmer, 2006; Ginns et al, 1995; Enochs and Riggs, 1990; Riggs and Enochs, 1990). The table 04 presents the validated version of the instrument:

FICTICIOUS NAME:		Gender:
Date:		Location:
How long have you been a teacher?		In Public Schools:
Age:		In Private Schools:
Classes you teach:		
Graduation Major:		Institution:
Year you started the course:		Graduation year:
Post-Graduation Course	Specialization/Institution:	Advancement/Institution:
	Master’s/ Institution:	Doctorate/ Institution:

In the questions below, mark with an X the item which is more in line with what you think or believe. The gaps relate to:

**FA: Fully Agree**

**A: Agree**

**I: Indifferent**

**D: Disagree**

**FD: Fully Disagree**

	FD	FD	I	A	FA
1 - Teachers consider the physical concepts accessible to all students.					
2 - Teachers believe that the physical concepts are very abstract and hardly understood by students.					
3 - Teachers believe that a student who has difficulties in mathematics is not interested in physics.					
4 - The problem of the student's motivation to learn physics resides in the student.					
5 - I feel capable in implementing experimental activities in my teaching.					
6 - I can join my academic background and my ability to motivate students during the Physics lessons.					
7 - I continually find better ways to teach Physics to my students.					
8 - When students' physics scores improve, it is often due to the teacher who found more effective teaching strategies.					
9 - I am not very effective in developing experimental activities.					
10 - I do not feel capable to teach Physics to my students.					
11 - A student's learning difficulty in physics can be overcome by a good teacher.					
12 - A student's low performance in physics is not the teacher's responsibility.					
13 - A teacher's major effort to teach physics produces little change in students' performance.					
14 - The performance of Physics students is directly associated to the efficacy of their teacher's teaching.					
15 - I encounter difficulties in explaining to students how the Physics experiments work.					
16 - I am always able to answer students' questions about Physics.					
17 - I know that I have the necessary skills to teach Physics to students.					
18 - When a student has trouble understanding a Physics concept, I usually know how to help him understand it better					

Table 04 – Final Version of Instrument

Although the validity study of the data collecting instruments is important, especially in quantitative research, we suggest recalling the observation that there is no final validation method, that is, the validity of the instruments should always be observed whenever the purposes of the research are required.

Because of the methodology chosen, the data collection instrument and review process, this research has some conspicuous limitations. Regarding the methodology, we opted for a correlational-type design, given that our analytical concern is to establish associations among these variables through correlations. This type of approach does not allow causal statements based solely on their results, as it is possible to accomplish this through conjectures with another theoretical reference. Another feature of this methodology is the need to minimize interferences in the data collecting process.

Thus, we hope to contribute to the research on the beliefs of Brazilian Physics teachers so that we can better understand which elements influence the teacher-student relationship regarding motivation in the classroom.

## **BIBLIOGRAPHY**

- BRITNER, S. L.; PAJARES, F. (2006). Sources of Science Self-Efficacy Beliefs of Middle School Students. *Journal of Research in Science Teaching*, 43 (5): 485-499.
- ENOCHS, L. G.; RIGGS, L. M. (1990). Further development of an elementary science teaching efficacy belief instrument: A preservice elementary scale. *School Science and Mathematics*, 90 (8): 694-706.
- GINNS, I. S.; WATTERS, J. J.; TULIP, D. F.; LUCAS, K. B. (1995). Changes in preservice elementary teacher's sense of efficacy in teaching science. *School Science and Mathematics*, 90 (1): 695-706.
- KATELHUT, D. J. (2007). The Impact of Student Self-efficacy on Scientific Inquiry Skills: an Exploratory Investigation in River City, a Multi-user Virtual Environment. *Journal of Science Education and Technology*, 16 (1): 99-111.
- PAJARES, F. (1992). Teachers' Beliefs and Educational Research: Cleaning up a Messy Construct. *Review of Educational Research*, 62 (3): 307-332.
- PALMER, D. (2006). Durability of changes in self-efficacy of preservice primary teachers. *International Journal of Science Education*, 28 (6): 655-671.
- PINTRICH, P.R.; MARX, R.W.; BOYLE, R.A. (1993). Beyond Cold Conceptual Change: The Role of Motivational Beliefs and Classroom Contextual Factors in the Process of Conceptual Change. *Review of Educational Research*, 63 (2): 167-199.
- RIGGS, I. M.; ENOCHS, L. G. (1990). Toward the development of an elementary teachers science teaching efficacy belief instrument. *Science Education*, 74 (6): 625-637.
- SCHUNK, D.H. (1991). Self-Efficacy and Academic Motivation. *Educational Psychologist*, 26 (3): 201-231.
- SMOLLECH, L. A.; YODER, E. P. (2008). Further development and validation of the Teaching Science as Inquiry (TSI) Instrument. *School Science and Mathematics*, 108 (7): 291-297.
- WOOLFOLK, A. E.; HOY, W. K. (1990). Prospective teacher's sense of efficacy and beliefs about control. *Journal of Educational Psychology*, 82 (1): 81-91.
- ZUSHO, A.; PINTRICH, P.R.; COPPOLA, B. (2003). Skill and will: the role of motivation and cognition in the learning of college chemistry. *International Journal Science Education*, 25 (9): 1081-1094.



## Remote Experiments for Teaching Quantum Physics within the Integrated e-Learning Strategy

Pavel Brom, František Lustig

Charles University in Prague, Faculty of Math and Physics, Laboratory of General Physics Education (both).  
Address: Ke Karlovu 3, CZ-121 16 Praha. E-mails: [Pavel.Brom@mff.cuni.cz](mailto:Pavel.Brom@mff.cuni.cz), [Frantisek.Lustig@mff.cuni.cz](mailto:Frantisek.Lustig@mff.cuni.cz)

**Abstract:** In our contribution we describe two remote experiments on quantum physics phenomena as a part of integrated e-learning. The integrated e-learning strategy involves e-text with the theory, real remote experiments, and simulations or applets to demonstrate and explain phenomena in an attractive way [1]. There are many nice applets or simulations available [e. g. [PhET.colorado.edu](http://PhET.colorado.edu)], but only few remote experiments providing real experimental data concerning the topic quantum physics.

In our remote laboratory [www.ises.info](http://www.ises.info) [2] we build up remotely controlled experiments to support the integrated e-learning strategy. Concerning only quantum physics phenomena, we would like to present a new remote experiment on the photoelectric effect where the volt-ampere characteristics of a vacuum phototube is measured. The experimental data are discussed and compared with the virtual experiment output data (i. e. the data from simulations or applets on the photoelectric effect). This experiment has been added to the other remote experiment on the Heisenberg uncertainty principle using the single slit diffraction, created earlier. One can verify the principle inequality  $\Delta y \Delta p_y \geq \hbar/2$ , where  $\Delta y$  is equal to the slit and  $\Delta p_y$  can be determined from the width of the zero-order maximum of light intensity in the diffraction pattern. Both remote experiments that require only the Java Runtime Environment to their control are available at [www.ises.info](http://www.ises.info) with an overview, e-texts and a list of links to the other real and virtual experiments. A proposal of the teaching-learning sequence is included. We recommend to use real remote experiments for the presentation and a careful study of the phenomenon, whereas virtual experiments are suitable for explanation of the physical background [3].

### Introduction

The means of the integrated e-learning strategy we focus on here are virtual experiments (i. e. applets, simulations) and real remote experiments [4]. They both can be regarded by students and teachers as attractive and modern tools, aids for the physics education that help students to start to understand difficult topics as well as to remind the phenomena anytime later thanks to an unordinary and practical experience. We present here a proposal of the teaching-learning sequence within the introductory course into quantum physics phenomena at the secondary school and the university level. In the first part (A) the photoelectric effect is studied, in the second part (B) we talk about the Heisenberg uncertainty principle. We suggest how to use the means of integrated e-learning, and we provide typical results with an interesting discussion and explanation. The lack of a vacuum phototube is not more an obstacle when it can be shared in the form of a remotely controlled experiment. It can be available to anyone, from anywhere and almost anytime (if one doesn't need to wait in a queue usually for several minutes), and without any registration required. It is possible to include the described means in the class, in students' labworks or homework, during exams [5] (ready students may relax while they are interacting with an applet or a remotely controlled experiment [6]). In case of homework, a student is not limited by time like in the class. Opportunity to repeat the measurement, to spend more time on interaction with an applet or remote experiment is the

main advantage of the integrated e-learning strategy for teaching and learning such difficult phenomena.

### Simple preparation

It is necessary only once to download (copy) and install the JAVA Runtime Environment (JRE, available for free) on all PC stations. Then we can recommend to download the selected applets like the „Photoelectric Effect“ [7] on the stations for a case that the Internet connection would be slow or lost during sessions.

### Proposal of the Teaching-Learning Sequence

#### A-1. The Presentation of the Photoelectric Effect

We suggest to present the new phenomenon during classes with the use of a real remote experiment if the Internet connection is stable and fast. (A virtual experiment, or a screen video should be ready, for a case.) The teacher should describe the circuit and its components (mercury lamp with interference filters F1–F5 providing well-defined wavelengths, picoammeter – high input impedance amplifier, voltage source, and the vacuum phototube Phywe whose volt-ampere characteristics we are going to study). The students should try to predict (and perhaps explain – see the quotes) the results for these cases, which should be verified a little while afterwards.

- Shall we observe any current while changing the voltage with the shielded phototube in the circuit? („No current, like with a capacitor instead of the phototube – open circuit for DC voltage.“)
- Shall we observe any current when the cathode is lit by infra-red radiation with the peak wavelength 940 nm, for example? („Who knows, perhaps we shall.“) No photocurrent is observed!
- Shall we observe any current when the cathode is lit by light of any other wavelength? („We don't know now, let's try it.“) We repeat preferably the automatic measurement for any more selected filter positions F1-F5 (see the fig. 1), meanwhile the students should note the differences, changes and give hypotheses. We do observe some photocurrent and some kind of its dependence on the wavelength.
- More possible questions: Why there was no photocurrent with the LED 940 nm? What is the dependence on the wavelength like?

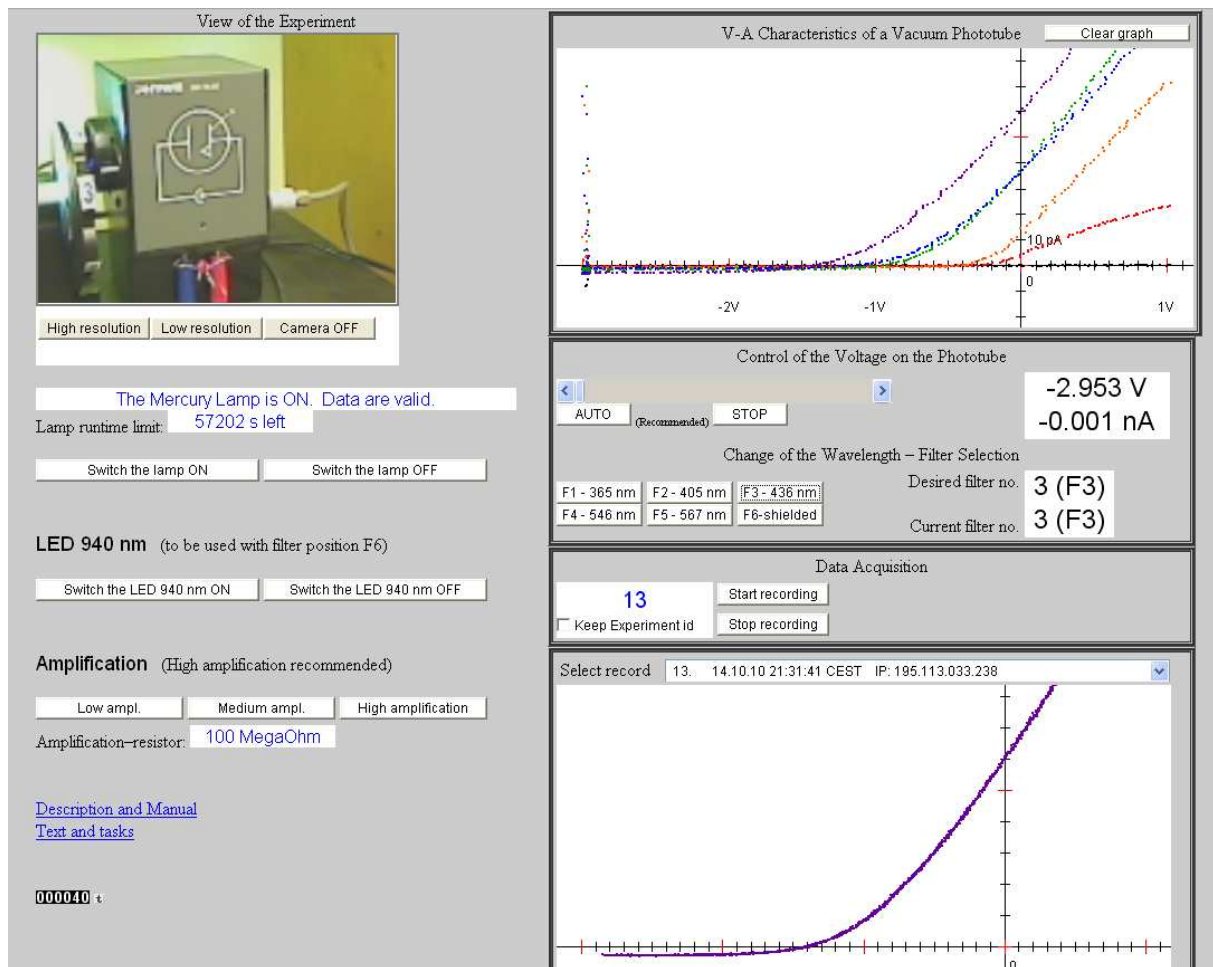


Fig. 1.: The view of the main part of the user interface: Measurement of the volt-ampere characteristics of the Phywe vacuum phototube can be remotely controlled by buttons in the right panel, with data acquisition. Additional control buttons are available in the left panel.

## A-2. Explanation of the Photoelectric Effect

For the explanation we strongly recommend to use simplified visualisation of the phenomenon, provided e. g. by the applet in the fig. 2-a from the PhET project ([3], [7]). With this applet we can simulate the similar behaviour observed in the real remote laboratory and to present the Einstein's explanation of the photoelectric effect using the quantum (photon) hypothesis. The PhET applet is very well designed, various dependences may be plotted, the origin of the photocurrent and the observed threshold character can be illustrated. The teacher may switch between the wave and the corpuscular visualisation. In order to compare the dependences, the set of three graphs can be stored as a screen shot before some of the graphs are cleared due to any change of free parameters. See the fig. 2-b.

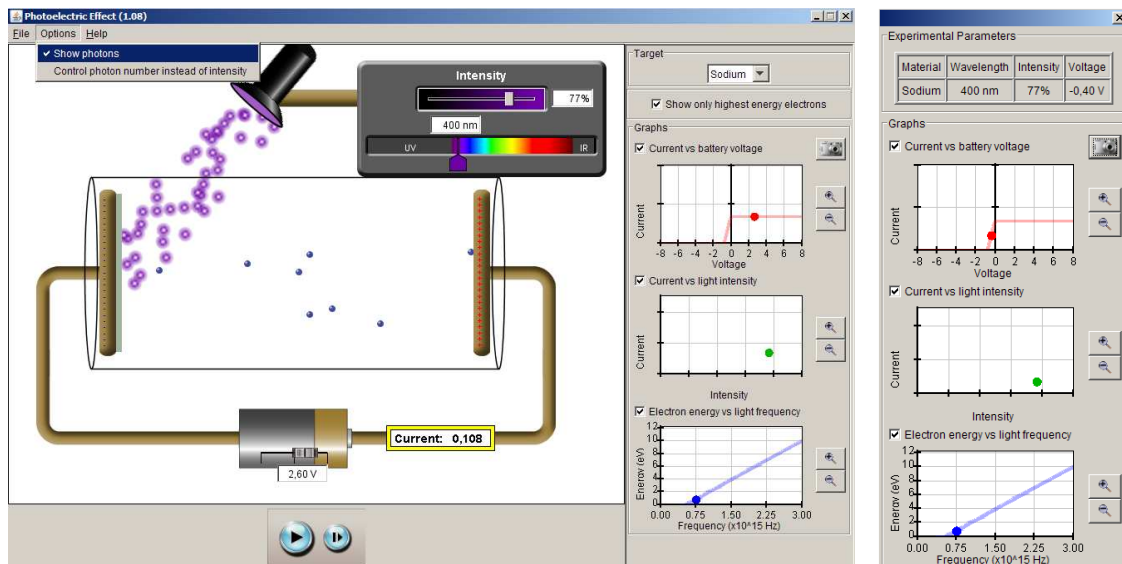


Fig. 2: a) View of the user interface of the virtual laboratory „Photoelectric Effect“ [7] from the PhET project ([3], [7]), b) example screen shot of the set of graphs for the comparison.

After the teacher has explained the background of the photoelectric effect and its threshold behaviour, the work function  $W$  can be introduced and by the application of the energy conservation law one can derive the Einstein's formula for the photoelectric effect  $hf = W + E_k$  where  $h$  is the Planck constant,  $f$  is the frequency of the elmg. radiation, and the kinetic energy  $E_k$  of electrons emitted from the photocathode is usually determined by the stopping voltage method, which should have been illustrated in the applet. The stopping voltage  $U_0$  determines the kinetic energy of electrons  $E_k = e |U_0|$  where  $e$  is the charge of electron in the absolute value.

### A-3. Labworks

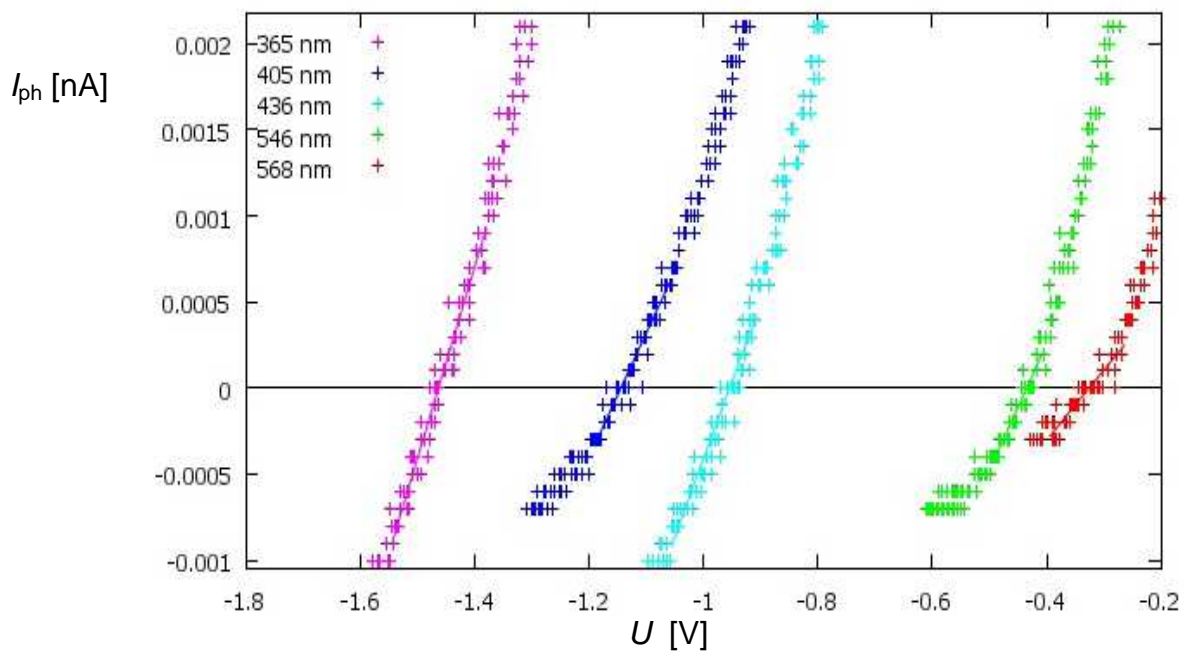
There are three usual ways for students how to get practical experience with the photoelectric effect: a) traditional hands-on (when a vacuum phototube is available), b) measurement in a real remote laboratory (real data with noise, more contributions to the photocurrent, and perhaps systematic errors to be discussed), and c) measurement in a virtual laboratory (simplified case with results corresponding to the literature values). The teacher's choice should consider many aspects like the school curriculum, students' skills and knowledge, goals, etc.

The most important goals and tasks are the determination of the experimental value of the Planck constant  $h$  and the work function  $W$ . We assume that the stopping voltage  $U_0(\lambda)$  is equal to the zero-photocurrent voltage determined from the volt-ampere characteristics (for details see the discussion).

Secondary school students should be able to read the experimental values of  $U_0(\lambda)$  from the graphs (the V-A characteristics) with some estimation of the errors. University students should apply some advanced methods of data processing like fitting/smoothing the data to consider the noise, and perhaps to consider the offset of the photocurrent amplifier (that is almost zero). We share the results for a very simple method – linear fits in small, almost linear intervals with the centres at  $U_0(\lambda)$  as tangents (see the graph 1). The linear fits were performed by the scientific freeware gnuplot [8] that determined errors of the fit – see the table 1 and the graph 2.

Table 1: Results of the linear fits with errors of the fits

Wavelength $\lambda$ [nm]	Stopping Voltage $U_0$ [V]
365	$1,46 \pm 0,07$
405	$1,14 \pm 0,07$
436	$0,95 \pm 0,07$
546	$0,44 \pm 0,05$
568	$0,33 \pm 0,04$
$h_{\text{fit}} [10^{-34} \text{ J}\cdot\text{s}]$	$6,12 \pm 0,08$
$W$ [eV]	$1,68 \pm 0,04$

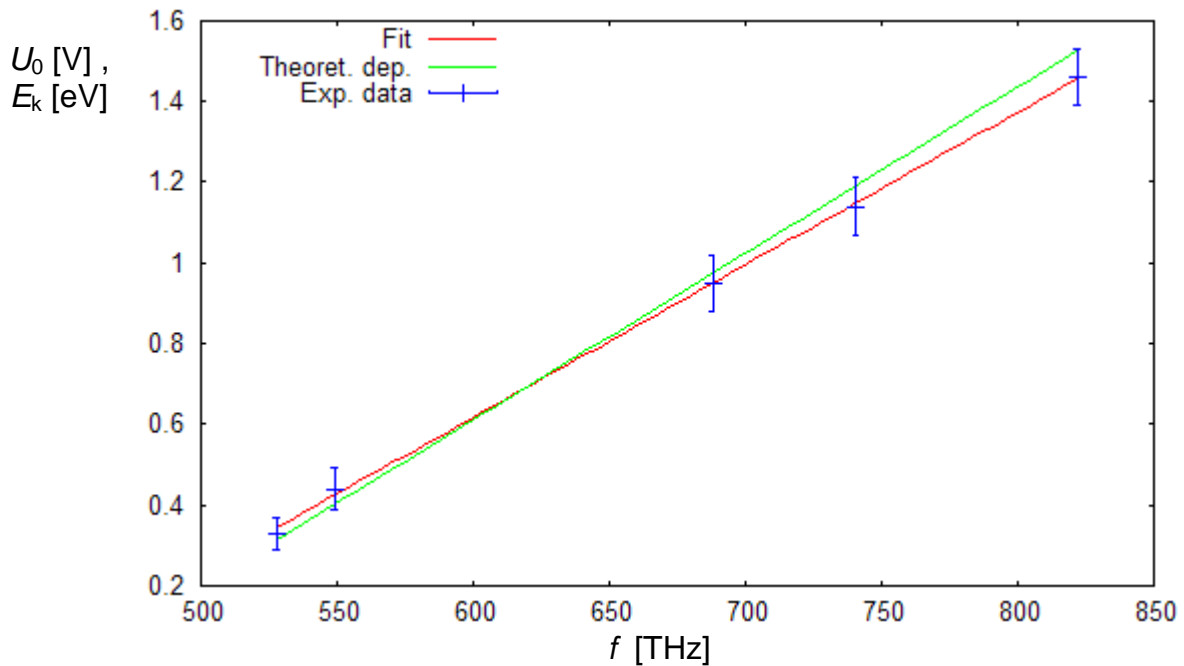


Graph 1: The volt-ampere characteristics of the Phywe vacuum phototube for certain wavelengths  $\lambda$ . Linear fits (tangents) at zero photocurrents ( $I_{\text{ph}} = 0 \text{ nA}$ ) to determine the stopping voltages  $U_0(\lambda)$ .

Finally from the dependence  $U_0(f)$  where the frequency  $f$ , the wavelength  $\lambda$ , and the vacuum light velocity  $c$  are in the relation  $f = c/\lambda$ , we can determine the experimental value of the Planck constant and the work function. Secondary school students may use the lowest and the highest measured point  $U_0(f)$  to be the most precise, perhaps they may use MS-Excel-like software for the linear fit. University students should perform linear fit via parameters  $A$ ,  $B$ :

$$|U_0(f)| = \frac{h}{e} \cdot \frac{c}{\lambda} - \frac{W}{e} = \frac{h}{e} \cdot f - \frac{W}{e} = A \cdot f + B \quad \Rightarrow \quad h_{[\text{Js}]} = \frac{10^{-12} \text{ THz}}{\text{Hz}} \cdot e_{[\text{C}]} \cdot A_{[\text{V/THz}]}, \quad W_{[\text{J}]} = -eB, \quad W_{[\text{eV}]} \equiv -B.$$

Results of the fit ( $A \approx 0,00382 \text{ V/THz}$ ) can be seen in the graph 2 and the table 1 (see the value  $h_{\text{fit}}$  with the error of the fit determined by gnuplot [8]). The relative errors of the results correspond to the small relative errors of  $A$  and  $B$ .



Graph 2: The linear fit through experimental points  $U_0(f)$ . Their errorbars are equal to the errors of the fit (see the graph 1 and the table 1). For the comparison, theoretical dependence for the literature value of  $h$  and the work function 1,87 eV is added.

#### A-4. Discussion

The accuracy of determination of stopping voltages  $U_0(f)$  from the volt-ampere characteristics is limited by noise. Our experience is that all five experimental points (measured by automatic scans for F1–F5) always follow a line with respect to their errorbars, which might be a good verification of the Einstein's formula. Moreover, the temperature (e. g. due to the temperature dependence of the work function), geometry of the experiment, the state and the runtime of the mercury lamp with luminophore may influence the slope (deviations up to 4%). Comparing the result experimental value  $h_{\text{exp}} = (6,1 \pm 0,1) \cdot 10^{-34}$  J·s to the literature value  $6,63 \cdot 10^{-34}$  J·s, the presence of the source of systematic error is clear. We can speculate about its origin, e. g. unwanted contributions to the photocurrent, leakage of electrons, which causes the stopping voltages (and  $h_{\text{exp}}$ , and  $W$  as well, see the graph 2) to be smaller than expected values. When we consider the errorbars in graph 2 determining the possible error of the results, we can measure the Planck constant and the work function with the relative error up to 10 %, which can be regarded as a success for such simple measurements of very low photocurrents. Then we can rather present results  $h_{\text{exp}} = (6,1 \pm 0,6) \cdot 10^{-34}$  J·s and  $W = (1,7 \pm 0,2)$  eV.

Furthermore, we can observe negative photocurrent and its saturation for higher negative voltages (the beginnings of V-A characteristics usually show capacitor discharging). The explanation and its verification is very complicated but we can answer students' questions simply by the photoelectric effect on the anode (especially on some impurities there) because a very small amount of light is reflected from the large photocathode to the anode although the anodes in Phywe vacuum phototubes are well shielded and the leakage current that can be also determined (at the filter position F6) is very low. The saturation of photocurrent from the cathode could be observed up around 20 V, the qualitative differences before saturation may be caused by different electric fields around the anode (a straight wire, greater gradient) and around the large half-circle photocathode (lower gradient), the quantitative differences by

their areas and geometry. This is another kind of source of the systematic error because we always measure the sum of contributions to the photocurrent. All these V-A characteristics measured by the Keithley picoammeter 6487 with internal voltage source had very similar properties and behaviour and they produced the same results.

## B. Heisenberg Uncertainty Principle

Another real remote experiment on the „Diffraction on microobjects“ (created in 2007 by F. Schauer, F. Lustig and M. Ožvoldová) can be used for an illustration and interesting application of the Heisenberg uncertainty principle where the common inequality  $\Delta x \Delta p_x \geq \hbar/2$  is rewritten for  $y$ -axis. Theory is explained in details in the e-text [9]. When a slit  $d$  can be determined from the positions of minima (or maxima) of the light intensity in the diffraction pattern and is assumed to be equal to the uncertainty  $\Delta y$  of the photon position while passing through the slit, then the uncertainty  $\Delta p_y$  must increase after the slit gets narrower – for sure: the width of the zero-order maximum (the position of the first minimum in the direction  $\alpha_{\min 1}$  – see the angle in the fig. 3) in the light intensity pattern becomes wider, which might have been predicted by students so that the principle inequality would remain valid. Thus using the formula for the momentum  $p = h / \lambda$ , its uncertainty  $\Delta p_y$  can be examined in this way:  $\Delta p_y = 2 p \sin \alpha_{\min 1} = 2 h \sin \alpha_{\min 1} / \lambda$ . Considering  $\hbar = h/(2\pi)$ , we have:

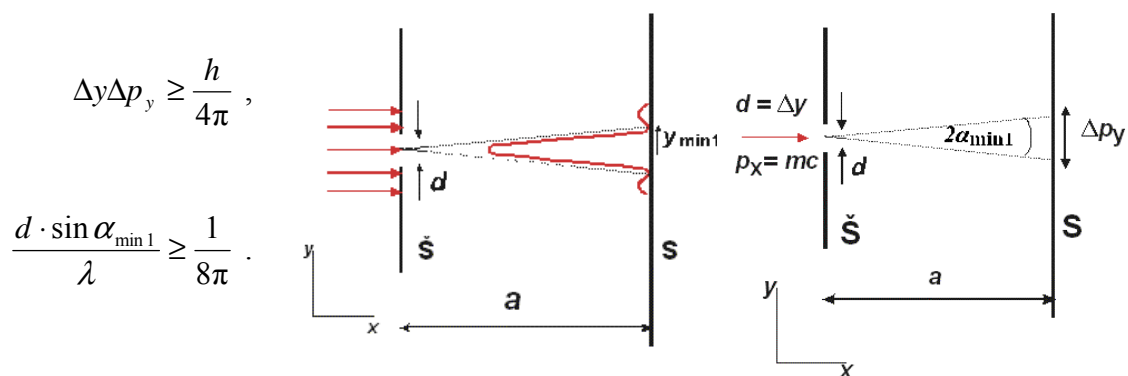
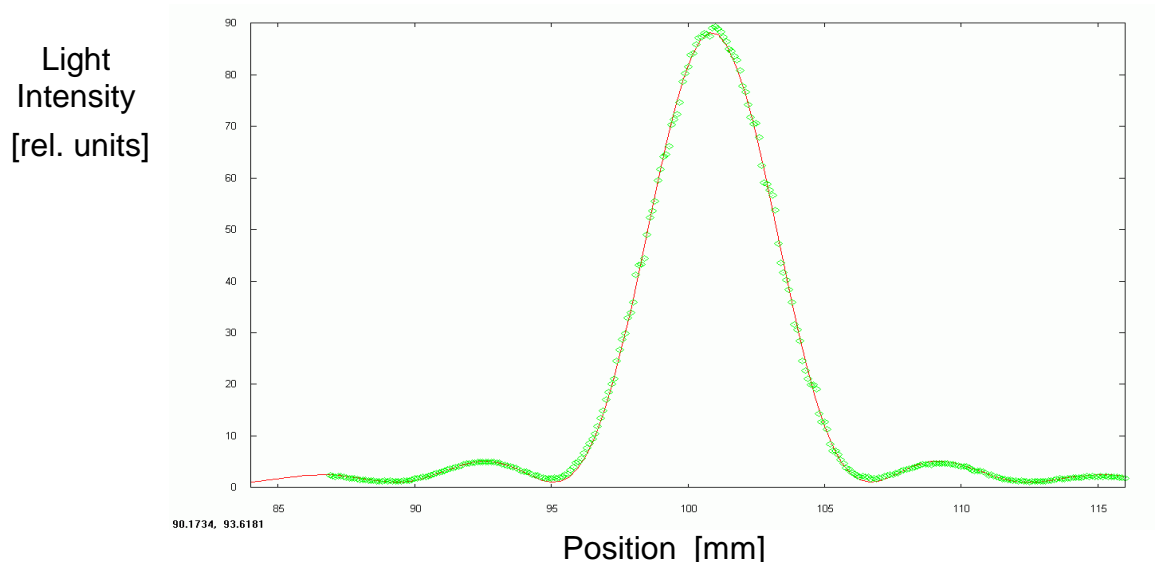


Fig. 3: Geometry of the remote experiment for the verification of the Heisenberg uncertainty principle (F. Schauer, [9]).

For red laser beam ( $\lambda = 632 \text{ nm}$ ) and the narrow slit ( $d = 0.231 \text{ mm}$  as a fit parameter, see the result fit in the graph 3), we have the inequality approx.  $1.00 \geq 0.04$ , therefore we have succeeded to verify the Heisenberg uncertainty principle in this case.





Graph 3: The theoretical fit of the diffraction pattern to determine the slit and the width of the zero-order maximum as well.

The main pedagogical goals are:

- Opportunity for interactive teaching and learning, for students' predictions followed by verification with the use of remotely controlled experiments.
- Using simplified visualisation (PhET applets) to explain the physical background.
- Students should determine one of the universal constants, with the error.
- Students will learn how to consider noise (data fitting or smoothing, estimation of the error).
- Students will try to solve a complex problem (perhaps considering the offset).
- Students learn about typical problems with low photocurrent measurements (noise, offset of the amplifier, leakage current, ...).
- Students test themselves whether they understand the theory well when they have to determine  $h$  and  $W$  from real or virtual experimental data.
- Students practise calculations with the usage of correct units.
- Students learn and progress in the basics of graphical data processing (data fitting), reading from graphs, verifying theoretical models (e.g. Einstein's formula), etc.
- Students have opportunity to discuss their experimental results that almost correspond to the literature value (systematic error, etc.).
- The modern means of integrated e-learning help students to start to understand more difficult topics and complex problems.

## Conclusion

We have suggested a teaching-learning sequence within the integrated e-learning strategy for teaching introductory topics of quantum physics in an attractive way. Remote measurements with data acquisition can be done as a homework with no time limitations (each student needs different time to start to understand).



We managed to build up real remote experiment to study the photoelectric effect where the new phenomenon can be interactively presented and later studied carefully with many interesting advantages and possible goals described in the text. For the explanation of the photoelectric effect, its threshold character, its measurement method (stopping voltage), etc. we strongly recommend to use the simplified applet from the PhET project. The teacher can change settings for the best visualisation; moreover, the applet can be used for data acquisition where the result Planck constant corresponds to the literature value. From the real experimental data we have the result Planck constant and the work function

$$h = (6,1 \pm 0,6) \cdot 10^{-34} \text{ J}\cdot\text{s} , W = (1,7 \pm 0,2) \text{ eV}.$$

It is possible to verify the Einstein's formula for the photoelectric effect with the relative error around 10 %. Furthermore, one can verify the Heisenberg uncertainty principle in another real remote experiment studying the diffraction on a single slit.

### Acknowledgment

The presented e-laboratory park was supported by grant of the Ministry of Education, Youth, and Sport of the Czech Republic: *Development of the Hardware and Software Equipment for ICT at the Charles University in Prague, Fac. of Math and Physics – E-laboratory of Real Remote and Interactive Physics Experiments.*

### Literature:

- [1] Schauer, F., Ožvoldová, M., Lustig, F.: *Integrated e-Learning – New Strategy of Cognition of Real World in Teaching Physics*. In Aung, W. et al. (eds.): *INNOVATIONS 2009: World Innovations in Engineering Education and Research*, iNEER, USA, 2009, 119–135.
- [2] Schauer, F., Lustig, F., Ožvoldová, M.: *ISES – Internet School Experimental System for Computer-Based Laboratories in Physics*. In Aung, W. et al. (eds.): *INNOVATIONS 2009: World Innovations in Engineering Education and Research*, iNEER, USA, 2009, 109–118.
- [3] Wieman, C. E., Adams, W. K., Perkins, K. K.: *PhET: Simulations That Enhance Learning*. *Science* 322, 682 (2008).
- [4] Eckert, B., Gröber, S., Jodl, H. J.: *Distance Education in Physics via Internet*. *Am. J. Dist. Edu* 23 (2009), 3, 125–138.
- [5] Thomsen, C., Scheel, H., Morgner, S.: *Remote Experiments in Experimental Physics*. Proceedings of the ISPRS E-Learning 2005, June 1-3, Potsdam/Germany, June 2005.
- [6] Ožvoldová, M., Schauer, F., Lustig, F., Dekar, M.: *Real Remote Mass-Spring Laboratory Experiments across Internet-Inherent Part of Integrated E-Learning of Oscillations*. *iJOE*, Vol. 4, No. 1 (2008).
- [7] Applets and methodical materials available at <http://PhET.colorado.edu>. (Cited 1. 9. 2010.)
- [8] Kelley, C., Williams, T. et al.: gnuplot, <http://www.gnuplot.info>. (Cited 1. 9. 2010.)
- [9] Schauer, F., Lustig, F., Ožvoldová, M.: *Remote laboratory on the Heisenberg uncertainty principle, Physical Background*, <http://www.ises.info>. (Cited 1. 9. 2010.)

# **Ethical issues in Physics: the convergence between STS and History of Science in the example of Radioactivity**

Marinês Domingues Cordeiro ([marinesdc@hotmail.com](mailto:marinesdc@hotmail.com))

Otávio Bocheco ([o.bocheco@gmail.com](mailto:o.bocheco@gmail.com))

Graduate Program in Science and Technology Education – PPGET-UFSC – Brazil

## **Introduction**

The current goals of science education point to the need for better training of students in epistemological terms. Various lines of research such as the history of science, STS and socioscientific issues share that goal, despite their different viewpoints on how to achieve it.

A notable trend in that area is to seek for epistemological contributions. Over the past twenty years, the critique of empiricism has prevailed, making use of ideas of great philosophers of science like Kuhn, Feyerabend, Lakatos and Bachelard. However, the very area of philosophy of science has expanded its views, and it becomes essential to seek renewals for epistemological frameworks that may better suit the desires of the academic community in science education.

This work brings some of the philosopher of science Helen Longino's ideas that, bypassing the strong (and criticized) relativism of the authors listed above, proposes a return of objectivity in science and the analysis of the values that influence it.

Her ideas are well fit with the plurality of educational propositions in the area of science education. Given this characteristic, this paper makes a first trial of a new epistemological perspective to the teaching of modern physics, exploring the specific example of the discovery of isotopes.

## **The objectivity of science, by Helen Longino (1990)**

It's in the book *Science as a Social Knowledge*, her first work on epistemology, published in 1990, that the author argues the objectivity of science lies on its character of being a social enterprise, immersed in various values, external or internal to the scientific inquiry. Her conception of science is considered different from many others, by bridging the gap between philosophy and the social studies of science. The differences between the two areas, according to Longino, propitiated “*a logical analysis [of science] that is historically unsatisfactory and a historical analysis that is logically unsatisfactory*” (LONGINO, 1990, p. 64).

Longino defends the social character of science by explaining that scientific knowledge is not the mere pooling of knowledge produced by individual scientists, but being produced through the interaction, the criticism, and the modifications of that individual knowledge throughout the scientific community.

*Experiments get repeated with variations by individuals onther than their originators, hypotheses and theories are critically examined, restated, and reformulated before becoming and accepted part of the scientific canon. What are known as scientific breakthroughs build, whether this is acknowledged or nor, on previous work and rest on a tradition of understandings, even when the effect of the breakthrough will be to undermine those understandings. (LONGINO, 1990, p. 68)*

The author then argues that one of the clearest evidence of this social aspect of science is the need for publishing the research results and hypotheses. Therefore, a paper is not only submitted to peer review, but also to the scrutiny of other scientists, who will systematically

refine those results. The criticism of fellow scientists is an even more complex process. *“Once propositions, theses, and hypotheses are developed, what will become scientific knowledge is produced collectively through the clashing and meshing of a variety of points of view”* (LONGINO, 1990, p. 69).

This is where the author sees the possibility of achieving objectivity in science, and not in its empirical characteristic. The experimental results, she explains, are themselves liable to subjective assumptions, for they are necessarily constructed and interpreted in the light of background considerations.

*Because the relation between hypotheses and evidence is mediated by background assumptions that themselves may not be subject to empirical confirmation or disconfirmation, and that may be infused with metaphysical or normative considerations, it would be a mistake to identify the objectivity of scientific methods with their empirical features alone. The process that can expose such assumptions is what makes possible, even if it cannot guarantee, independence from subjective bias, and hence objectivity.* (LONGINO, 1990, p. 75)

With this overview of Longino’s understanding of what really is the social dimension of science - something much more complex than ever previously described - she sums up by saying that this intersubjectivity is what constitutes the objectivity of a program or theory. Scientific knowledge, according to Longino, is both social in the ways in which it is created, and in its uses.

### **Science, values, and possibilities to science teaching**

To Longino, the epistemic values are not the only influences on theory choice. She states that there are values outside the scientific enterprise - social, political, economic, technological, and ethical - which pressure science. The classical understanding of the relationship science/values assumes that such contextual values can actually interfere, however seeing it from a model of "externality". This model foresees that contextual values can only influence on the choice of the research that should be continued or funded, and which should be neglected. The very possibility of contextual values acting internally to scientific practice, according to the classical view, would necessarily entail in bad science.

On the other hand, Longino argues that in some cases, contextual values can and should guide scientific decisions. In many of them, epistemic values only would be unable to ponder the consequences of a survey; moral and social values should take part in the decision of the continuity of a program. Thus, contextual values cease to be outsiders, becoming constitutive values of the activity. The objectivity and public confidence can be maintained as a consequence of this change in perspective.

Longino’s perspective illustrates one facet of science traditionally hidden by the science education. By focusing on teaching content only, it would be very difficult to teach *about* science, besides scientific concepts (Matthews, 1995). This has been systematically addressed by academics in the area. In the opinion of several lines of research, reversing the little inclination to science presented by the general public goes through offering, in the classroom, much more than well established concepts. Among those lines of research, one might mention science-technology-society (SOLOMON, 1993), socioscientific issues (ZEIDLER ET AL, 2005; ZEIDLER & SADLER, 2008), and the history of science (MATTHEWS, 1992).

Despite having been developed separately, this link between the lines of research certainly does not make them incommensurable, yet we observe rare efforts to use them to

converge, creating a body of knowledge and solid educational proposals, with opportunities to reach diverse students and environments. The peculiarities of each line, rather than acting as an element of distinction between them, can play the exact opposite role; it can enrich the teaching practices whenever appropriate.

Take, for instance, the possibility of bringing to classroom some socioscientific issue. The history of science, especially the science of the 20th century, is rich in episodes full of socioscientific issues, historical passages that lead discussions on the ethical values involved in the consolidation of scientific theories. Usually, these episodes bring influences from outside the scientific realm, which can be treated from an STS perspective.

For this sort of multifaceted approach, a new epistemological perspective is necessary. Traditionally, the research in science education has used the ideas of epistemologists as Lakatos, Popper, Feyerabend, and in particular, Thomas Kuhn and Gaston Bachelard. These ideas, though very fruitful with regard to the critique of empiricism, have been targeted to criticism on the level of philosophy of science. Admittedly, this is an area of knowledge marked by the eternal criticism and wide variety of viewpoints; however, in order to teach the nature of science, in its philosophical and sociological terms, nothing is more important than the systematic addition of new perspectives.

As already mentioned, the work of Helen Longino is an attempt to fill in the gap between philosophy and sociology of science, and therefore she was chosen in this work to offer another point of view on science. Moreover, as has become customary in the area of science education, this is a prospect that has great potential to be used as background to an approach as the one proposed here.

By investing in the role of values (epistemic, contextual and constitutive), Longino offers an understanding of the nature of science that can be treated from the approaches to socioscientific issues, philosophy of science and STS. Thus, with the analysis of the values involved in a particular historical episode, many may prove to be epistemic - which would bring up philosophy of science - other, may prove to be constitutive (ethical, moral and social) - enabling the analysis of socioscientific issues - and, finally, some may be characterized as contextual values - allowing the STS approach. It would not be utopian if, after such discussions about values and their roles in science, side by side to the familiarity of scientific concepts involved in this historic passage, the student would finally approach a posture that could be defined as scientifically literate.

### **Contextual and constitutive values in the research of radium sources**

During the first decade of the 20<sup>th</sup> century, the scientific community was faced with a completely renovated science. The phenomena that emerged at the end of the previous century drew attention to their applications and the incredible ability to reveal a universe certainly unknown in the times of classical science. Radioactivity was one of them.

Discovered in France in 1896 by Henri Becquerel, radioactivity had not caused any furor among physicists until Marie Curie published her research on the radiation emitted from uranium and thorium, in 1898. In Canada, Ernest Rutherford and Frederick Soddy took a step toward understanding the nature of the phenomenon in 1903, publishing the hypothesis of the disintegration of radioactive elements. With this theory, and the enrichment of radio, thirty new radioactive elements were discovered, as intermediate products of decay series of uranium and thorium.

Radium, the most radioactive chemical element enriched so far, had shown its great commercial possibility, because of the enormous energy emitted when decaying. Even in 1905, Pierre Curie already demonstrated the scientific community's concern with the applications of radium, describing studies in geology, meteorology and medicine. He also raised the possibility of using radio for malicious purposes (CURIE, 1967).

Because of the multiple possibilities of use of that element, much research was being conducted, in the quest for sources of it. Frederick Soddy was already in Britain in 1910, when he discovered the chemical identity of an emanation of uranium – called mesothorium I – and radio. However, Otto Hahn in Germany already knew that identity and ways of extracting mesothorium I, yet keeping such information a secret.

Freedman (1979) explains that at the time Otto Hahn worked for the German industry, and could be keeping their research a secret in order to later patenting the discoveries, and this would have bothered Frederick Soddy (SODDY, 1967). The latter, who had already been motivated by the potential use of radium in medical research, began to investigate ways of extracting mesothorium I.

His findings yielded fruits more quickly than those of Hahn, and therefore Soddy is considered the father of isotopy. It's essential to note that he patented the discovery, though simultaneously publishing all their results. Despite having rights over the isotope of radium, he opened up to the entire scientific community the extraction procedures.

The relationship with industry was not a privilege to Hahn; Soddy's father-in-law and close friend was a great industrial chemist. He gave conditions to Soddy for his research, and its results were applied in the industry.

Which is effectively the difference between the postures of Hahn and Soddy, if they both worked for the industry and conducted their researches driven by commercial and social (contextual) values, in the possibility of exploring a radium source for the sake of their countries? Why, then, the attitude of Soddy seems more consistent with the science ethos?

Soddy did not hurt the rule of publicity of the scientific work, and it seems that the fact that Hahn had done so bothered and encouraged him to keep himself focused on the goal. Soddy let a contextual value to influence his research; however, it did not hurt the scientific practice, because at the same time he patented his discovery - ensuring that it was always attributed to him, not Hahn - he also published the procedures, thus allowing all those who needed a radium source to produce it. This contextual value, in Soddy's practice, became a constitutive value in his science.

### **A possible proposition: final considerations**

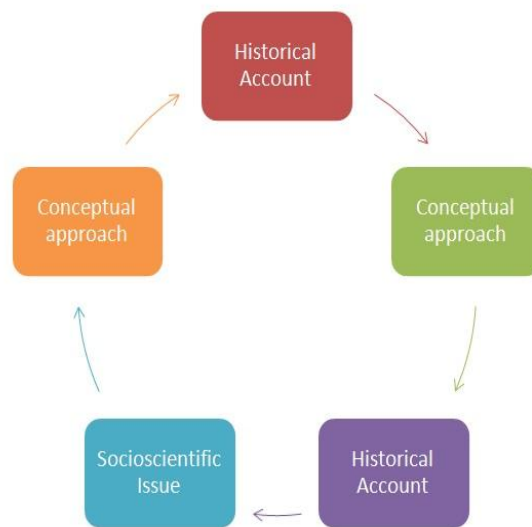
A possible test is offered to teachers interested in approaching the hereby present historical episode socioscientifically and in terms of STS education.

Santos et al (2009), concerned with a citizenship driven science education, developed a way of broadly accessing a theme. The idea, according to the authors, is to develop "spiral" curricular settings, where, scientific concepts are introduced by the theme. From those concepts, one seeks to return to the theme again.

Based on this spiral format, one can plan a mini-course in physics related to the topic of radioactivity, beginning from the socioscientific issue linked to the acceptable ethical posture of a scientist facing the unexpected value of their discovery or hypotheses. The historical episode on the discovery of radium sources would be a good example to bring up this point. The discussion on patents, in this specific illustration, has the potential to develop moral and ethical discussions on the scientific activity, which can help students mature their ideas on the property of discovery and scientific and technological applications that have the power to cause harm and benefits to all human beings, as well as generating wealth.

One cannot forget that physics classes are not lessons on history and philosophy of science. For this, one must also address concepts and phenomena from a scientific viewpoint. Thus, in approaching the historical episode on the discovery of radium sources, concepts or scientific phenomena arise, such as emanations, isotopy, radioactive decay and so on. These will require a theoretical approach to concepts or mathematical models.

Back and forth discussions between socioscientific issues, history of science, and the teaching of science concepts will be promoted in teaching physics and about physics. The scheme presented below illustrates the pedagogical structure of this proposed trial.



## References

CURIE, P. Radioactive Substances, especially Radium. In: **Nobel Lectures, Physics 1901-1921**. Amsterdam: Elsevier, 1967.

FREEDMAN, M. I. Frederick Soddy and the Practical Significance of Radioactive Matter. **The British Journal for the History of Science**. v. 12, n 42. 1979.

LONGINO, H. E. **Science as a Social Knowledge: values and objectivity in scientific inquiry**. Princeton: Princeton University Press, 1990.

MATTHEWS, M. R. History, philosophy, and science teaching: the present rapprochement. **Science&Education**, 1(1), 11-47, 1992.

SANTOS, W. L. P. et al. Química e Sociedade: um projeto brasileiro para o ensino de química por meio de temas CTS. **Educació Química EduQ** n. 3, p.20-28, 2009.

SODDY, F. The origins of the conceptions of Isotopes. In: **Nobel Lectures, Chemistry 1901-1921**. Amsterdam: Elsevier, 1966.

SOLOMON, J. **Teaching Science, Technology and Society. Developing Science and Technology Series**. Bristol: Taylor and Francis, 1993.

ZEIDLER, D. L. et al. Beyond STS: A research-based framework for socioscientific issues education. **Science Education** 89: 357–377, 2005.

ZEIDLER, D. L.; SADLER, T. D. Social and ethical issues in Science Education: a prelude to action. **Science and Education**, 17: 799 – 803, 2008.

## Reform of curriculum in Slovakia as a challenge for physics education

Peter Demkanin, Soňa Chalupková, Viera Lapitková, Zuzana Šuhajová  
Faculty of Mathematics, Physics and Informatics, Comenius University in Bratislava,  
Slovakia  
[demkanin@fmph.uniba.sk](mailto:demkanin@fmph.uniba.sk)

### Introduction

In the last few years radical changes are done in physics education in Slovakia. The basic document ruling the content and goals of physics education has been developed and authorised in the parliament as a part of National Curriculum (ŠVP), the implementation of the external final exams in physics has been stopped, and work on a new series of textbooks has been initiated. All these changes are done very quickly in time pressure, without broad enough discussion and without allocation of necessary resources. This conference presentation and paper brings some of the parameters of these changes and prognoses some consequences.

Physics as compulsory subject in Slovak curriculum has allocated 10 week hours (45 min) as in table 1.

**Table 1.** Physics in ŠVP – after reform

grade	6	7	8	9	1	2	3	4
age	12	13	14	15	16	17	18	19
physics minimum	1	1	2	1	2	2	1	0
optional together	6	6	6	6	4	4	7	15

Table 1 includes also allocation for optional subjects. Some of these week-hours can be allocated to physics (by the management of the school, or in some bigger schools by pupils). Even if schools allocate some of the optional week-hours to physics, there still can be seen radical reducing of this subject. The allocation before this reform is presented in table 2.

**Table 2.** Physics before reform

grade	6	7	8	9	1	2	3	4
physics	2	2	2	2	3	3	2	2
optional	0	0	0	0	0	0	4	4

Such radical changes and also quite obsolete curriculum issued in necessity to prepare the physics curriculum in new format. Firstly, we saw the high pressure to physics content. Teachers used to teach content based curriculum could not easily adapt to teaching less content in less time.

### Physics at the age of 16-19

This paragraph focuses to the last 4 years before final exams (so to 4 years' gymnázium and last 4 years of 8 years gymnázium). The most radical change is splitting of curriculum into two parts, one for every student (grades 1 and 2, partly 3; age 16, 17, 18) and second - curriculum for final exam in physics (grades 3 and 4; age 18, 19). Before the reform we had in Slovakia compulsory courses in each of physics, chemistry and biology at the level of final exam (equivalent of A-level); after the reform we try to implement the idea to teach for final

exams only 2 years (within optional courses) and so make the compulsory physics less pragmatic (so not as a training for final exam) and more fun and with better balanced goals. The inspiration was the curriculum of International Baccalaureate (IBCA, 2010) and National Curriculum in England – KS3 and KS4 (Frost, 2005).

So we decided to change the goals of physics education for age 16-17 and also the content. All together we have 150 lessons, 45 min each for physics. We allocated 40 hours (out of 150 hours) for a direct pupil's work on physics empirical cognition (including planning of experiments, assembling apparatus, measurement, presentation of the outputs, but excluding data processing, writing reports and teacher's demonstrations). These experiments are not allocated to specific physics content by the National Curriculum (ŠVP). This part of curriculum is focused on pupil's competences and teacher should match these hours to content by themselves. This allocation is compulsory, but each teacher/school can fill it up with her/his favourite experiments. So we have 110 hours for content based curriculum. Of course we still need to develop the basic and subject related competences of pupils within these hours. This was the most difficult (and we hope never ending) work. What is absolutely clear, we need to have a cross section of contemporary physics available on secondary school level of understanding in this content, we should have content to high level comparable with the rest of world, we should go deep enough to develop subject specific competences, and we must not be too strict in formulations to keep enough space for textbooks authors and teachers/schools specialization. On the other hand we should be strict and clear enough to allow national comparison of schools/pupils educational results. Within this frame we saw that is not possible to adapt previous content to these circumstances. So we prepared new form, based on our previous research in this field.

If we compare the previous and new content, we see that some content is new. Here we bring it only in some points: using of proper number of digits; planning of pupils' experiment, defining of a problem, stating a hypothesis; linearization of a diagram; energy of food; energy in our body; energy in housing, travelling, industry; Doppler effect; role of research and researchers in physics in society; physical base of information, digital technology.

### **Utilisation of the knowledge and competences gained via informal and non-formal education**

How was the textbook content created? How was it fulfilled with the activities? In the previous syllabus, e.g. the topic sound was mentioned only from the point of view of mechanical wave. There were few hours allocated to it. Students learned only about the basic properties of sound as a wave. Within the frame of reform there is more time and place devoted to this interesting topic. There are 15 lessons allocated to chapter Oscillations and waves, including the sound. What are the objectives of this topic? The textbook for 2<sup>nd</sup> grade (age 17) in the frame of reform can help us. Student should be informed about different types of waves. She/he should be able to read information from the graph describing wave. In the textbook there is also new content (new from the point of view of Slovak physics education). One of it is Doppler Effect and its widespread use in practical applications. Last but not least we can't omit the properties of standing waves as a basis for functioning of musical instruments. The textbook doesn't forget human hearing, loudness. When writing the textbook, we wanted to include information and related topics about sound, which can be accessible to students, information which can interest students and on the other side, students should have some experiences with it. Therefore we would like teachers don't forget on own students' knowledge. They meet sound everywhere. They create sound, they are listening to music and some of them play musical instrument. When we connect school, formal, education



with the experiences from out-of-school activities, we can enrich the educational process and we fulfill the given time more effectively.

Students have many possibilities how to get knowledge and experience. The information society brings opportunities to gain information from the field of interest. They must attend school, they can create and choose informal groups; they can join work of clubs. At home there is television and internet is being the normal part of everyday life of a common family.

We explored out-of-school knowledge of 3<sup>rd</sup> grade (age 18) students. The students wrote pretest as a first step before talking about sound. We were curious about their knowledge in the area of sound, ultra-, and infrasound and related topics. Questions were varied. Some of them were related to musical instruments. Other questions concerned physiology of hearing, supersonic aircrafts and utilization of Doppler Effect in medicine and traffic. From this one lesson questionnaire (called pre-test) we acquired valuable information about knowledge of our students. From the pre-test we found out, which student is an expert in which part of the topic. We had a sort of “information map” of our class. So we were able to select some students and assign them a role of experts. Some of such students played, even if a few minutes, the role of experts. Their expertise was very helpful when teaching new topic. As the teacher obtained information about his experts in the classroom, he could effectively include their knowledge. Teacher also knew what the students are able to know, because he had “information map” of his class.

There were almost 250 students who wrote pretest and they were from schools all over the Slovakia. The results of pretests varied much, but we didn't find a regional aspect affecting the results of pretest. Generally, students have much important information the teacher can use. Even if the questions in the pretest were constructed in the way to avoid information from previous school physics education, the answers were often sufficient, sometimes overcoming the expectations. Based on the students' answers the teachers were able to adjust their lessons.

### **Utilisation of MBL and other digital technology tools**

There is a big difference, concerning the state before the reform, related to student's experimental work. The National Curriculum allocated 40 hours (as minimum) for direct pupil work on experiments. At the same time we try to ensure, that this amount of time will be spent effectively from the point of students cognition. The time spent on the most time-consuming parts of experimental work, such as data processing and writing reports must be excluded or minimized. One of proven already possibility how to do this is to use computers for data processing and analysis or use data-logging. Computer based measurements are widely recommended for their educational gains, e.g. developing the competence of graph reading, deeper understanding the observed phenomena by creating direct connection between observation and data results (Brassel, 1985), (Mokos & Tinker, 1987)(McFarlane & Friedler, 1995). Accompanied with the proper strategies supporting active learning the impact on pupil's knowledge has been proven (Sokoloff & Thornton, 2004), (Zucker & all, 2007)

The question was, to which level the schools and students in Slovakia are prepared to use digital technologies. The research has been made on the availability of computers and computer equipped physics laboratories. The survey among students (age 15-16) in Bratislava showed that 98% of students have their own computer and 69% proclaimed also having possibility to bring his own notebook to the school (Šuhajová, 2010). In other parts of Slovakia the number of students having their own computers is lower, but we expect it will grow in the following years. It seems to be clear, that schools should follow this trend.

The next question was how to scaffold the computer based activities by textbooks design. In the former Slovak physics textbooks the data logging has been proposed as a teacher demonstration activity with student not directly working with experiment. Our research has been focused on searching proper strategies, methodology and developing the scenarios for lessons for those parts of curriculum, where using data logging seems to be profitable and testing the newly designed activities among students.

In the textbook we directly incorporated several computer based activities based on experimental student work and modeling. The activities include direct participation of students on pupils planning experiments.

In the textbook for first year of gymnasium (age 16) only small number of teaching sequences connected with direct data-logging appears directly incorporated into the text. The emphasis is put on data-processing, analysis of measured or modeled results. We have used software environments Excel and Coach 6. Advanced mathematical operation such as a derivation is introduced in the context of mechanics as a speed of changing a quantity, e.g. displacement for definition of instantaneous velocity. Several problems from real life situations are proposed to be solved with the use of computer modeling.

The textbook for second year of gymnasium contains instructions for student experimental work with data logging, such as exploring gas properties, exploring properties of different sounds, measuring of speed of sound, measuring magnetic field strength, observing fall of magnet through the coil, observing light bulb shimmering, exploring current and voltage in circuit with coil or in alternating current.

As mentioned before, not each of these experiments is compulsory and the teacher/school can use the most favourite experiments taking into consideration the equipment available and specialization of the school.

In the early phases of the reform a research in MBL utilisation in physics education in Slovakia as a part of European project EuISE has been done. We formulated some findings. (Demkanin, 2008). Here are some of them:

In discrepancy with situation from 20 years ago, reported e.g. by (Beurs & Ellermeijer, 1993) we do not see any necessity to teach students to use the software. The research done with more than 400 students (age 15-18) on software Coach5, Coach6 on the level of measurement, data processing and presentation proved that the students only need to be informed about parameters of the system. Software is so user friendly that we can start to use it on an intuitive level. This finding does not apply for software for modelling and videomeasurement, here some instructions are necessary if we want students to use them independently and effectively. From this angle of view it is good, if these parts of software are joined in one software environment, such as Coach6. This finding does not apply for teachers; teachers need some instructions and training.

The supply of equipment (interface and sensors) is necessary to complement also by teacher training. We found as effective 3-4 days face to face training and at least 1 year distant learning with final report demanded from each participating school. The supply without face to face teacher training and also teacher training some months before supply we found as not effective. Short teacher training (1-2 hours) done without instant delivery of equipment to school can be considered just as an information for the teacher and inspiration for teachers to activate them in effort to gain the equipment (e.g. for writing good school projects as a reaction to projects calls). Some schools (teachers) seem to be unable to procure goods (any type needed for education) which they both desire and can afford.

Incorporation of ICT tools (data loggers) offer much more activity oriented education and this shift can be strengthened by curriculum and textbooks design.

The truth that ICT tools has potential to activate students is fully proved by many researches - these tools can provide students with quick response to their actions – at the same level in direct measurement, as in modelling. On the other hand, this potential is not self-exploiting. To take advantage of ICT tools, these should be not taken as something odd, or special, but should be incorporated into the whole process of physics education.

The MBL tools we effectively use in measurements and experiments, in laboratory and field work. But some students and also some teachers are to high level exams centred; they try to prepare themselves for exams and quite often do not follow all goals of physics education. We have tried (and not only us) to incorporate some aspects related to MBL tools also to written exams questions. On our pre-search we see, that such questions in written exams motivate teachers in including MBL experiments in their teaching plans and also bring them ideas for new attitudes and new experiment designs.

Focusing students' laboratory work to planning, data collecting, data processing, evaluation, manipulative skills and personal skills has been proved as effective way in keeping the students active. The combination of this new (new in Slovakia) strategy together with new equipment made the laboratory work much more effective in relation to time and also in relation to the goals of physics education. The design of experiments by students takes some time and we should allocate this time. Quite reasonable number of teachers considered this time as not effectively spent. With such teachers we should patiently discuss the goals of physics (science) education.

#### Acknowledgement

Preparation of this paper has been supported by the project PHYS-WEB, Visegrad Fund, 20910347 and Ministry of Education SR, VEGA 1/0625/10

#### References

Brassel, H. (1985). The effect of real time lab graphing on learning graphing representation of distance and time. *Journal of Research in Science Teaching* , 223-228.

Demkanin, P. (2008). One small, but significant step in science education in Slovakia. In P. Demkanin, B.Kibble, J.Lavonen, J.G.Mass, & J. Turlo, *Effective use of ICT in Science Education*. Edinburgh: University of Edinburgh.

Frost, J. (2005). The Science Curriculum. In J. Frost, & T. Turner, *Learning to Teach Science in the Secondary School*. London: Routledge.

IBCA. (2010). *International Baccalaureate Organisation*. Retrieved from [www.ibo.org](http://www.ibo.org)

McFarlane, A., & Friedler, Y. (1995). Developing an Understanding of the Meaning of Line Graphs in Primary Science Investigations Using Portable Computers and Data Logging Software. *The Journal of Computers in Mathematics and Science Teaching* , 461-480.

Mokos, J., & Tinker, R. (1987). The impact of microcomputer-based labs on pupil's abilities to interpret graphs. *Journal of Research in Science Teaching* , 369-383.

Sokoloff, D., & Thornton, R. (2004). *Motion and force – Laboratory Curriculum and Teacher's guide*. Beaverton, USA: Vernier.

Šuhajová, Z. (2010). Školský fyzikálny experimentr v počítačom podporovanom prírodovednom laboratóriu. Bratislava: FMFI UK.

Zucker, A., & all. (2007). Increasing Science Learning in Grades 3-8 Using Computers and Probes. Retrieved from TEEMSS II project: [http://www.concord.org/publications/detail/TEEMSS\\_NARST\\_2007.pdf](http://www.concord.org/publications/detail/TEEMSS_NARST_2007.pdf)

## Computer assisted symbolic calculations in university physics courses.

José-Luis Jiménez<sup>1</sup>, Ignacio Campos<sup>2</sup>, Gabriela Del Valle<sup>3</sup>,  
Guadalupe Hernández<sup>3</sup>.

<sup>1</sup>Departamento de Física UAM-Iztapalapa México D.F., [jlj@xanum.uam.mx](mailto:jlj@xanum.uam.mx)

<sup>2</sup>Departamento de Física, Facultad de Ciencias UNAM México D.F.,  
[jecampos@prodigy.net.mx](mailto:jecampos@prodigy.net.mx)

<sup>3</sup>Departamento de Ciencias Básicas, UAM-Azacapozalco México D.F.  
[ddg@correo.azc.uam.mx](mailto:ddg@correo.azc.uam.mx), [gpe@correo.azc.uam.mx](mailto:gpe@correo.azc.uam.mx)

### 1. Introduction

Learning and teaching theoretical physics is a hard work. It involves a clear understanding of the concepts, which usually are developed through years of fighting with them to make them useful in the description of physical reality. Usually these concepts, like mass, force, energy, etc., are taught since elementary school. Some simple examples are used to illustrate the use of these concepts, but the more complex examples are left aside because the mathematics is too involved. Recently some texts are including problems that can be solved numerically with the aid of a PC. Also, this tool is used to have graphics of some results of solving these physical problems. However, we have now a powerful tool in the software developed to make symbolic calculations. This tool increases the capability of calculation, but its usefulness depends on having a sufficiently clear understanding of the concepts involved as well as of the conceptual and mathematical structure of the respective theory. This conceptual clarity is also necessary for interpreting the solution to a given problem. In the present work we illustrate with two examples the possibility of using software of symbolic calculations to solve physical problems in which the mathematics is too involved. The examples discussed in this paper are useful for undergraduate students, who can benefit from critically reviewing some fundamental concepts of mechanics and detect some ingrained prejudices on the subject. It is also useful for advanced students, even at the graduate level, because these type of students can appreciate better the relevance of the study of systems with variable mass and the use of analytical mechanics techniques, as well as recognize the richness of a seemingly simple problem.

### 2. Dynamics of one end of a rope initially at rest with the other end.

This mechanical system consists of a rope of length  $b$  and density  $\rho$  initially with both ends fixed at the same horizontal level. Hence we have a one dimensional continuum. Then one end is left to fall. The questions to solve are: if one end is released: i) what is the tension in the other end? ii) what is the equation of motion that correctly describes the fall of one end? iii) what is the solution of this equation? iv) what is the velocity of the end that falls?. Usually only the first and last questions are discussed in textbooks, since the resulting equations are very complicated. However, the software of symbolic calculations permits to deal with this mathematically difficult problem, as we will show. These results are very useful in the teaching of intermediate and advanced courses on mechanics.

At first sight the problem is very simple, as we may corroborate in some texts on mechanics, but *the solution given there is erroneous!* A correct solution and understanding of this problem surely could be of extreme usefulness for education. Therefore it is convenient to describe the usual solution method given in a clear fashion by Marion and Thornton [1].

This problem has been tackled by different methods [2-4]. One is to substitute the rope by a “particle” of total mass  $M$  located at the center of mass. Then, if  $P$  is the momentum of the center of mass of the rope, the equation of motion proposed is

$$\dot{P} = Mg - T_A, \quad (1)$$

where  $T_A$  is the tension on the fixed end. If it is assumed that the end that falls is acted only by these forces (weight and tension), then since a length  $\left(\frac{b-x}{2}\right)$  of rope falls with velocity  $\dot{x}$ , the momentum of the system is

$$P = \left(\rho \frac{(b-x)}{2}\right) \dot{x}, \quad (2)$$

and equation (1) becomes,

$$\frac{dP}{dt} = \left(\frac{\rho}{2}\right) (-\dot{x}^2 + a(b-x)). \quad (3)$$

On the other hand, taking the free fall velocity as,

$$\dot{x} = gt, \quad (4)$$

that is,

$$\ddot{x} = g, \quad (5)$$

equation (3) may be written as,

$$\frac{dP}{dT} = \left(\frac{\rho}{2}\right) (gb - 3gx), \quad (6)$$

It is also easy to show that that Eq. (1) leads to

$$T_A = \frac{Mg}{2} \left(\frac{3x}{b} + 1\right). \quad (7)$$

On the other hand, if it is taken into account that the system is conservative, with kinetic energy  $K = \frac{1}{4} \rho (b-x) \dot{x}^2$ , potential energy  $V = -\frac{1}{4} \rho g (b^2 + 2bx - x^2)$  and total energy

$E = V(x=0) = -\frac{1}{4} \rho g L^2$ , one finds that

$$\dot{x} = \sqrt{\frac{g(2bx - x^2)}{(b-x)}}. \quad (8)$$

and

$$T_A = \frac{Mg}{4b} \left(\frac{2b^2 + 2bx - 3x^2}{b-x}\right). \quad (9)$$

Within this approach it can also be shown that

$$\ddot{x} = g + g \left(\frac{2bx - x^2}{b-x}\right) \quad (10)$$

We have then two different approaches which give different results. What is the correct approach, if any? We can see that even problems seemingly simple and elementary can lead

to conceptual difficulties whose analysis is very useful in teaching. How can we solve this discrepancy in methods and results?

One proposal is that of Calkin [2], who calculates the time of fall in order to see what of the above expressions is correct.

From the Eq. (8) for  $\dot{x}$  we find that

$$dt = \frac{dx}{\sqrt{\frac{g(2b-x)x}{b-x}}}, \quad (11)$$

which can be integrated by means of the change of variable  $x = \sin^2 \phi$ , giving

$$t = 2\sqrt{\frac{b}{g}} \int_0^\phi \frac{\cos^2 \phi'}{\sqrt{1 + \cos^2 \phi'}} d\phi' = \sqrt{\frac{2b}{g}} \left\{ 2E(\phi|45^\circ) - F(\phi|45^\circ) \right\}, \quad (12)$$

where  $F$  and  $E$  are elliptic integrals of first and second class respectively [5].

It is interesting that for  $x = b$ , ( $\phi = \pi/2$ ) the time of fall of the end  $b$  is [2]

$$t_b = \sqrt{\frac{g}{2b}} t_o \quad (13)$$

where  $t_o$  is the time of free fall. Thus  $t_b$  is *less* than the time of free fall.

Calkin also points out that tension in end  $b$  is, contrary to what is expected, not zero. Indeed, he argues that conservation of energy holds if the tension is continuous from one end to the other. Eq. (12) is an implicit solution of the equation of motion, but unfortunately it is not easy to obtain  $t$  from  $x(t)$ .

### 3. Discussion

We have then a poorly understood dynamics of a system, indicated by the lack of a sole equation of motion. A first step is to recognize that we have a variable mass system, and then we must use the pertinent equation of motion, that is [6-9]

$$\frac{\partial(m\vec{v})}{\partial t} = \vec{F} - \oint_S \rho \vec{v} \vec{u} \cdot d\vec{S}_{up} \quad (14)$$

The last term is the flux of momentum, and  $S$  is the surface that surrounds the control volume.  $F$  is the body force, that is, weight. In this case the same quantity of mass, with the same velocity, enters and leaves the control volume. Then the net flux of momentum is zero. Under these conditions we have the equation of motion

$$m\ddot{x} + \dot{x} \frac{\partial m}{\partial t} = mg \quad (15)$$

Since  $m = m(x)$ , then

$$\frac{\partial m(x)}{\partial t} = \frac{\partial m(x)}{\partial x} \dot{x} \quad (16)$$

Besides  $m(x) = \frac{1}{2} \rho(b-x)$ , so Eq. (15) becomes

$$\ddot{x} = g + g \left( \frac{2bx - x^2}{b-x} \right) \quad (17)$$

which is precisely Eq. (10).

#### 4. Another perspective

Obtaining result (13) is not too hard but, is there another way of obtaining it? Is there an approximation method? Approximating equations (11) or (12) looks very complicated, and result (13) does not emerge easily from the approximations. How can we proceed to obtain a feasible approximation? It is at this point that students appreciate subtle details in problems, and consider other more powerful methods, like those of analytic mechanics.

Since we have expressions for the kinetic and potential energies it is immediate to express the Lagrangian,

$$L = K - V = \frac{1}{4}\rho(b-x)\dot{x}^2 + \frac{1}{4}\rho g(b^2 + 2bx - x^2)$$

the Hamiltonian, and use the methods of analytic mechanics [10]. We have then the Hamiltonian

$$H = \frac{p^2}{\rho(b-x)} - \frac{1}{4}\rho g(2b-x)x \quad (18)$$

where

$$p = \frac{1}{2}\rho(b-x)\dot{x} \quad (19)$$

Since  $H$  does not depend on time explicitly we can use the formalism of Poisson to obtain an approximation to  $x(t)$ , that is [10]

$$x(t) = x_0 + t[x, H]_{t=0} + \frac{1}{2!}t^2[[x, H], H]_{t=0} + \frac{1}{3!}t^3[[[x, H], H], H]_{t=0} + \dots \quad (20)$$

where as usual Poisson brackets are defined as

$$[u, H] = \frac{\partial u}{\partial x} \frac{\partial H}{\partial p} - \frac{\partial u}{\partial p} \frac{\partial H}{\partial x}. \quad (21)$$

Now, the calculation of Poisson brackets is a very laborious task, but with the use of symbolic calculus by means of a PC it is easy to obtain

$$x(t) = \frac{1}{2}gt^2 + \frac{1}{24}g^2t^4 + \frac{1}{72}\frac{g^3t^6}{b^2} + \frac{47}{8064}\frac{g^4t^8}{b^3} + \frac{25}{9072}\frac{g^5t^{10}}{b^4} + O(t)^{12} \quad (22)$$

Since all terms are positive it is evident that this fall will be faster than a free fall.

However what we need is  $t(x)$ , which requires inverting the series (22). This is a hard work, unless we use a PC with symbolic calculus. It is easy then to obtain

$$\sqrt{\frac{g}{2b}}t = \left[ -\frac{1}{12}\frac{x}{b} - \frac{1}{32}\frac{x^2}{b^2} - \frac{13}{896}\frac{x^3}{b^3} - \frac{47}{6144}\frac{x^4}{b^4} - \dots \right] = 0.863258, \quad (23)$$

which is very close to result (13).

The relevant point is that result (13), hard to obtain by approximating (11) or (12), is now obtained easily with the aid of analytical mechanics and the use of a PC with capabilities of symbolic calculations. Examples like this can be used with profit in teaching intermediate or advanced courses on mechanics.

Of course once we have a Hamiltonian we can pursue other advanced methods, like the Hamilton-Jacobi method, that we will not discuss here

We have here an example of the power of analytical mechanics applied to a variable mass system. With this kind of examples the student can appreciate that the Lagrangian, Hamiltonian, and Poisson formulations of classical mechanics are much more than a mere preparation for quantum and statistical mechanics. Usually students are less familiar with the Eq. (14) for variable mass systems than with the methods of analytical mechanics, but this example shows that we can obtain immediately the equation of motion from the expressions for the kinetic and potential energies, since then we can construct the Lagrangian and Hamiltonian, and use the advanced methods which provide these elegant formulations of classical mechanics.

### **5. Calculation of the period of an anharmonic oscillator**

Some years ago F. M. Fernández [11] proposed an alternative method for calculating approximately, as a power series in energy, the period of the anharmonic oscillator. His method requires determining in each step of the approximation an approximate solution of the equation of motion at the same order of approximation than the approximation for the period. This makes the method simple but very laborious. It has been accepted as an interesting alternative since another method, that of canonical perturbations, which gives general expressions to obtain directly the frequency (and therefore the period), is usually avoided because of its great algebraic complexity, which makes it almost useless.

However, with the aid of symbolic calculus implemented in a PC, like in our first example, the result can be obtained easily to any approximation. There is no room to show the details, but we want to point out that symbolic calculations assisted by a PC open wide possibilities for teaching, since this facility permits to solve problems which because of its complexity were out of reach for most students.

### **6. Conclusions**

The examples discussed in this paper are useful for undergraduate students, who can benefit from critically reviewing some fundamental concepts of mechanics and detect some ingrained prejudices on the subject. We have developed an example which shows the subtleties of variable mass systems. Students are hardly acquainted with these systems, and even their teachers may have some confusion about these systems, as shows the fact that there are two approaches to solve this example, that give different results!

On the other hand, we have shown that the Lagrangian and Hamiltonian formulations provide powerful methods to solve these problems. Even more, the Poisson formulation, with few examples of application, in this example leads to an expeditious approximation to the solution. But this can be done practically only with the use of a PC with symbolic calculus software. This tool is used to have graphics of some results of solving these physical problems



and increase the capability of calculation. Then we have now a powerful tool in the software developed to make symbolic calculations.

## 6. References

- [1] Marion J.B. and Thornton, S.T. (1995), *Classical Dynamics*, 4th ed. (Saunders, Fort Worth, TX), pp. 38-340.
- [2] Calkin, M.G. and March, R.H., 1989, The dynamics of a falling chain : 1, *Am.J.Phys.*, Vol. **57** 2 pp. 154-159.
- [3] Schagerl, A., Steindl, A., Steiner, W. and Troger, H., (1997), On the paradox of the free falling folded chain, *Acta Mech.* **25**, 155-168.
- [4] Tomaszewski, W. and Pieranski, P. (2005), Dynamics of ropes and chains. I. The fall of the folded chain, *New J. Phys.* **7**, 45-61.
- [5] Gradshteyn I.S. and Ryzhik I. M. (1980), *Tables of Integrals, Series and Products*, (New York: Academic) p. 297.
- [6] Del Valle, G., Campos, I. and Jiménez, J.L. (1996), A Hamilton-Jacobi approach to the rocket, *Eur. J. Phys.* **17**, 253.
- [7] Campos, I., Jiménez, J.L. and Del Valle, G. (2003), Canonical treatment of the rocket with friction linear in the velocity, *Eur. J. Phys.* **24**, 469.
- [8] Jiménez J.L., Del Valle G. and Campos I. (2005), A Canonical treatment of some systems with friction, *Eur. J. Phys.* **26** 711.
- [9] Siegel, S. (1972), More about variable mass systems, *Am. J. Phys.* **40** 183.
- [10] Goldstein H., Poole Ch., and Saiko J. (2002) *Classical Mechanics* 3rd. edition, (San Francisco: Addison Wesley).
- [11] Fernández, F. M. (2001), Energy expansion for the period of anharmonic oscillators, *Eur. J. Phys.* **22** pp. 639-643.

## Four experiments on magnetic field at four Euros – Low-cost demonstrational experiments on Classical Electrodynamics for future physics teachers

Věra Koudelková, Leoš Dvořák

Faculty of Mathematics and Physics, Charles University in Prague, Czech Republic

[vkoudelkova@gmail.com](mailto:vkoudelkova@gmail.com)

### Introduction

Classical Electrodynamics is one of subjects studied by future high school teachers of Mathematics and Physics at Charles University in Prague in the third year of their bachelor studies. (Two more years of Master studies are required for these students to become qualified teachers but most of basic physics lectures are included in their bachelor studies.) The lecture on Classical Electrodynamics follows a basic lecture on Electricity and Magnetism (two years before) with the aim to extend and deepen students' knowledge and understanding in this field. Up to now this lecture has only been theoretical, being part of the course on Theoretical Physics for future teachers. We decided to enhance this lecture and supplement it with selected demonstrational experiments – relatively simple, low cost and not time consuming but nevertheless also quantitative ones. Though most of these experiments could be also used in the earlier lecture on Electricity and Magnetism our experience showed us that this lecture is already “overloaded” enough. So it is useful to return to many effects, formulas etc. again in Classical Electrodynamics, at a bit deeper level and with better understanding using the experience students gained in their first two years of their studies.

The article presents four experiments from the area of magnetism: Demonstration of Ampere's law, How to use an electric transformer to transform music, Dissipation of magnetic field and Simple demonstration of a multipole expansion.

The experiments use only simple and cheap instruments (ideally being the “experiments for 4 Euros”) to enable future teachers to use simpler versions of selected experiments also in their future teaching at high schools.

### Simple demonstration of Ampere's law

Is it possible to simply demonstrate Ampere's law of magnetic field?

Ampere's law describes the relation between magnetic field around a conductor and the current flowing through the conductor.

$$\oint_C \vec{H} \cdot d\vec{l} = I_{total} \quad (1)$$

To demonstrate the law we take a core of an electric transformer. We consider a closed curve  $C$  inside a core of the transformer (coinciding with a magnetic field line – see fig. 1).

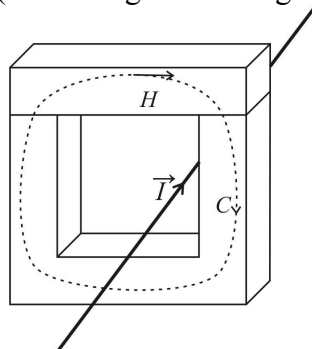


Fig. 1: Idea of Ampere's law demonstration using common school transformer

If we consider  $H$  to be approximately constant along the curve, we can take  $\oint_C \vec{H} \cdot d\vec{l} = H \cdot l$ ,

where  $l$  is the length of the curve. The total current  $I_{total} = NI$ , where  $N$  is the number of turns of the coil and  $I$  is the current through the coil. We arrive at a simple formula which enables us to find out the value of  $H$ :

$$H \cdot l = N \cdot I \quad (2)$$

Corresponding magnetic induction  $B$  is

$$B = \mu_r \mu_0 \frac{NI}{l}, \quad (3)$$

where  $\mu_0$  is permeability of vacuum and  $\mu_r$  is a relative permeability of the material of the core. If there is a thin gap between two parts of the core the value of (normal component of)  $B$  is the same in the gap as it is in the core. (Of course, the gap influences, perhaps even significantly, the value of the integral in (1) and this effect must be discussed with students. We will omit this discussion in this short article.)

All these formulas are well known to students and the theoretical reasoning indicated above is quite straightforward. Let us look how to demonstrate the dependence of  $B$  at  $I$  and  $N$  as simply as possible.

We have used a small Hall's probe to measure magnetic field inside a core of a common school transformer (see fig. 2). Hall's probe is in the centre of the gap.

The height of the Hall's probe is only 2 mm so the gap is thin enough and we can neglect it in the first approximation. (Lately we can improve our simple model and discuss with students that our first approximation is, in fact, crude enough. But it is not orders of magnitude wrong.)

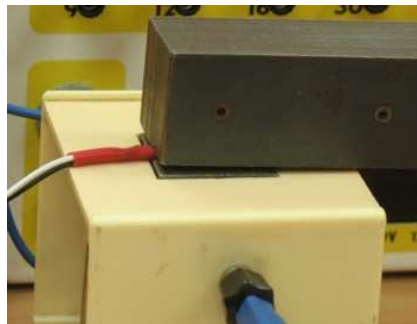


Fig. 2: Detail of the Hall's probe inside the gap of the transformer's core (to measure the dependence of  $B$  on  $I$ )

The arrangement of the experiment you can see in fig. 3. One multimeter measures voltage at the output from Hall's probe (from which we calculate the value of  $B$ ), second multimeter measures an electric current in the primary circuit. Batteries at the front are power supply for the Hall's probe. In the first experiment we have constant primary voltage for the coil (about 3 V) and change number of turns of the primary coil, which we wind from a wire.

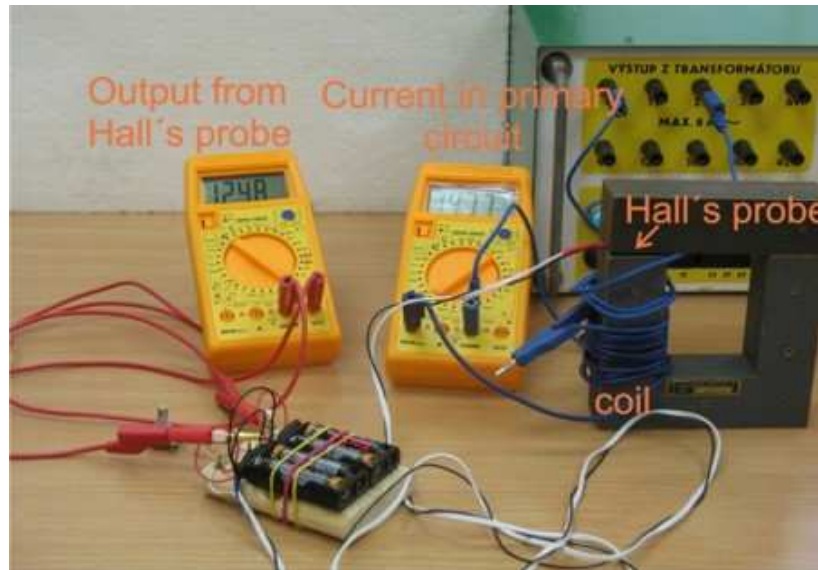
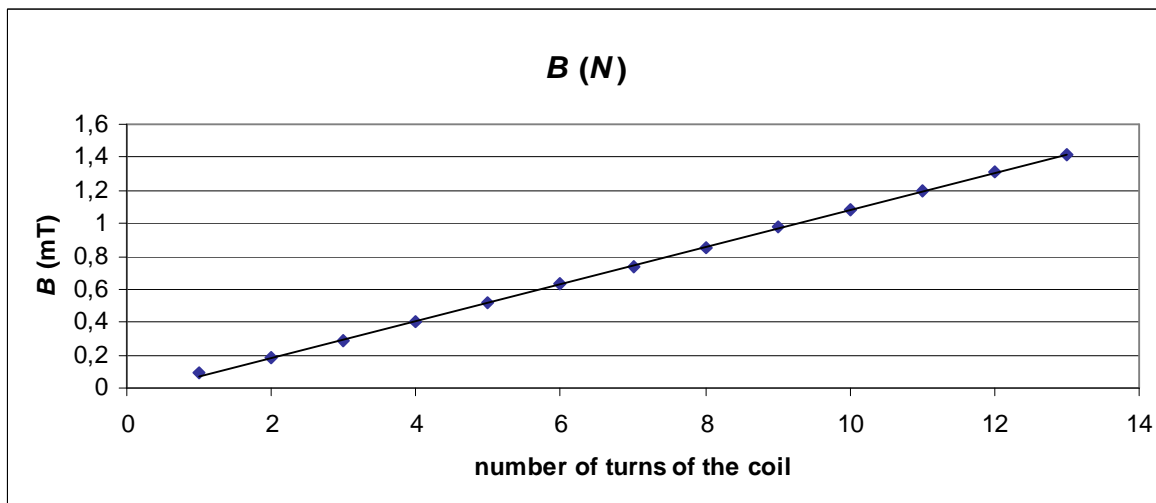


Fig. 3: Arrangement of the experiment  
(to measure the dependence of  $B$  on number of turns of the coil)

In the second experiment we have coil with 300 turns and change current in the coil. Minimum current we use was 55 mA, maximum about 260 mA. It's possible to demonstrate that dependence of magnetic field on a number of turns of the coil and on electric current is approximately linear (see fig. 4). Deviation from linear dependence can be caused by the fact that relative permeability of the ferromagnetic material of the core is not constant but changes with  $H$ . In the more detailed treatment students can find that this effect is diminished by an air-gap. If the influence of the air-gap is neglected (as in our derivation above), the experiment can be taken rather as an approximate demonstration of Ampere's law, not as an accurate quantitative measurement.



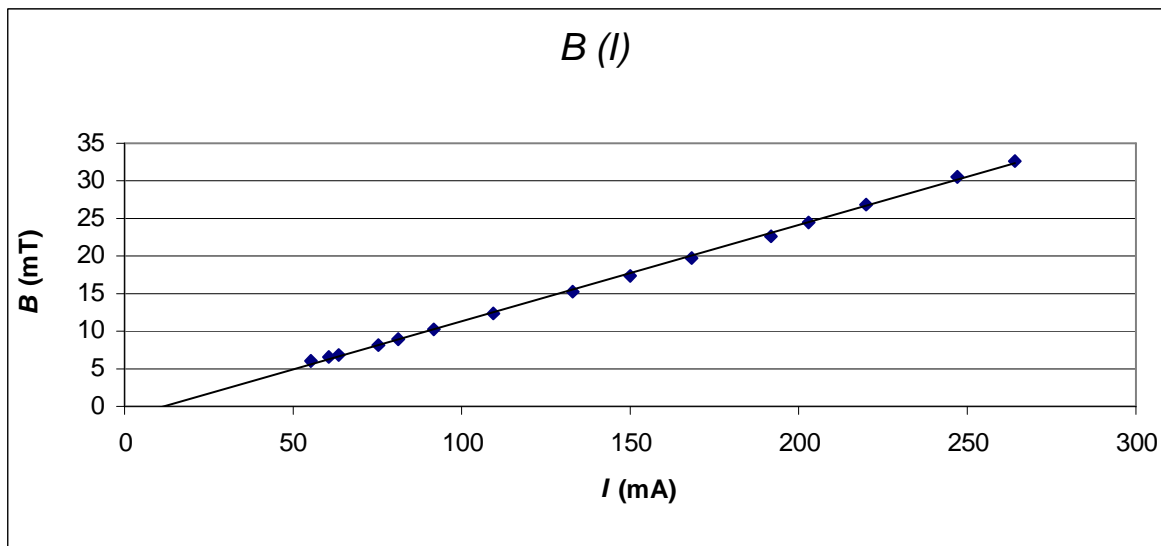


Fig. 4: Dependence of magnetic field: a) on number of turns of the coil, b) on an electric current

### “Transforming music”

When demonstrating the principle of an electric transformer one usually transforms only harmonic alternate voltage and uses only coils made from wire. Could it be possible to use something else instead of a wire? And is it possible to transform something more interesting than harmonic voltage?

In the following experiment we transform music and, to make the experiment more surprising for students, we can even use our fingers instead of wire in a “coil” (with just one turn). You can see the arrangement of the experiment in figure 5.

We use music from a small cassette-recorder. Amplified signal from this recorder powers primary coil (of 600 turns) of a transformer. In a first version of the experiment we use one turn of wire as a secondary coil. The second amplifier connected to a secondary coil is a simple amplifier with one transistor; its output is connected to the input of a sound card of a computer.

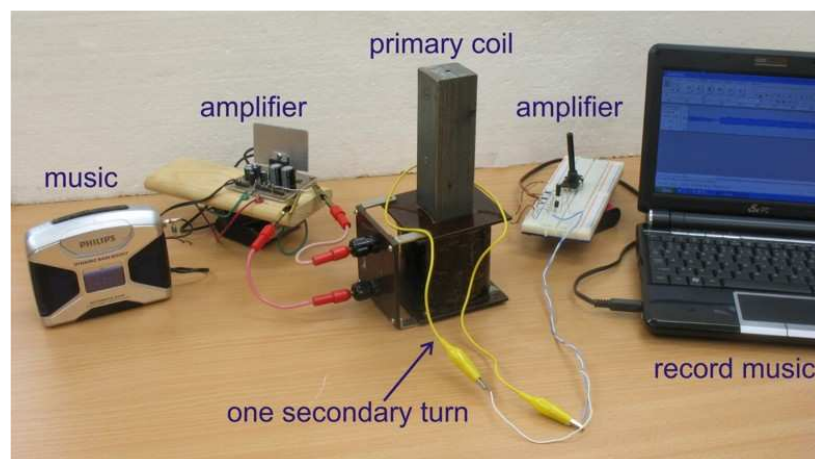


Fig. 5: Arrangement of the experiment

The notebook then acts as a speaker and a recording device. Output signal can be recorded for example by a program Audacity (you can see the output at fig. 6). One turn of secondary coil is enough to produce clear signal at the output. We can show that changing the diameter of the secondary turn does not change significantly the amplitude of the output signal. If we use two turns instead of one the amplitude grows twice.

In the second version of the experiment we use our fingers as a secondary coil instead of wire. Output is very noisy in this case, but the music can be clearly distinguished.

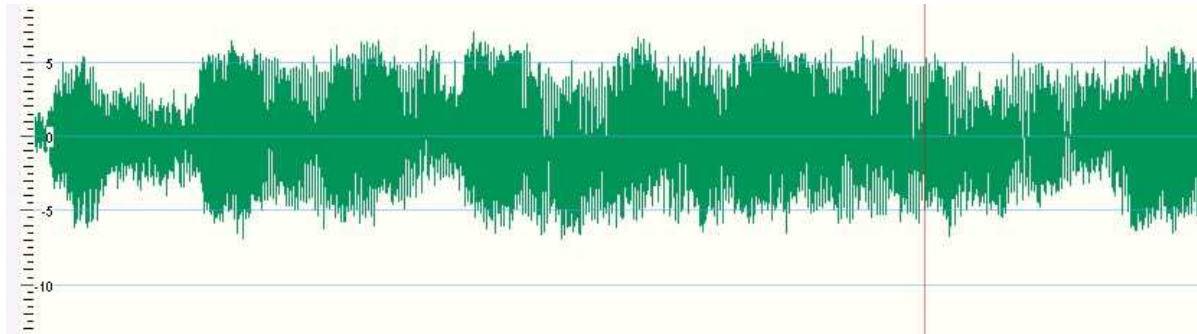


Fig. 6: Transformed music – output from the Audacity

### **Dissipation of magnetic field**

In most of usual school experiments with electric transformer we can see that not all magnetic flux flows inside the core of a transformer. Part of the magnetic flux dissipates around the core. As a consequence of this dissipation we can for example induce small voltage in one turn of wire which is near the electric transformer but not around the core.

The question can arise how large this dissipation is, i.d. what is the value of the magnetic induction outside the core.

For the experiment we use a core of a common school transformer which is built from two parts – the “U core” and the “I core”. There is a small gap between these cores, which is not usually present in commercial transformer’s cores. Using small Hall’s probe we measured magnetic field near the transformer’s core. To “power the transformer” we used a coil with 300 turns connected to the power source of 12 V AC.

Results of our measurement are shown in figure 7. In both measurements – at the top of the core and at the right side of the core – the Hall’s probe was very close to the core (it touched it). We measured the component of magnetic induction normal to the surface of the core. Let us note that we measured the dissipated magnetic field only at the central part of the top side, not near the front edge or the back edge of the core.

At the top of the core the value of magnetic field of the dissipated flux falls down from the left to right-hand side. The field starts to rise again close to the right-hand edge of the core. We found the maximum of the dissipated magnetic field at 0.5 cm from the left-hand edge of the core; its value was about 0.6 mT.

At the right-hand side of the core the dissipated magnetic field was nearly constant in the central part of the core (about 0.4 mT), rapidly increased near the gap of the core (to more than 1.6 mT) and slightly grew near the lower edge of the core.

The purpose of this experiment is rather to describe qualitatively or semi-quantitatively how the magnetic field dissipates from a core – precise quantitative explanation of this effect would be out of the scope of the lecture Classical Electrodynamics for future physics teachers.

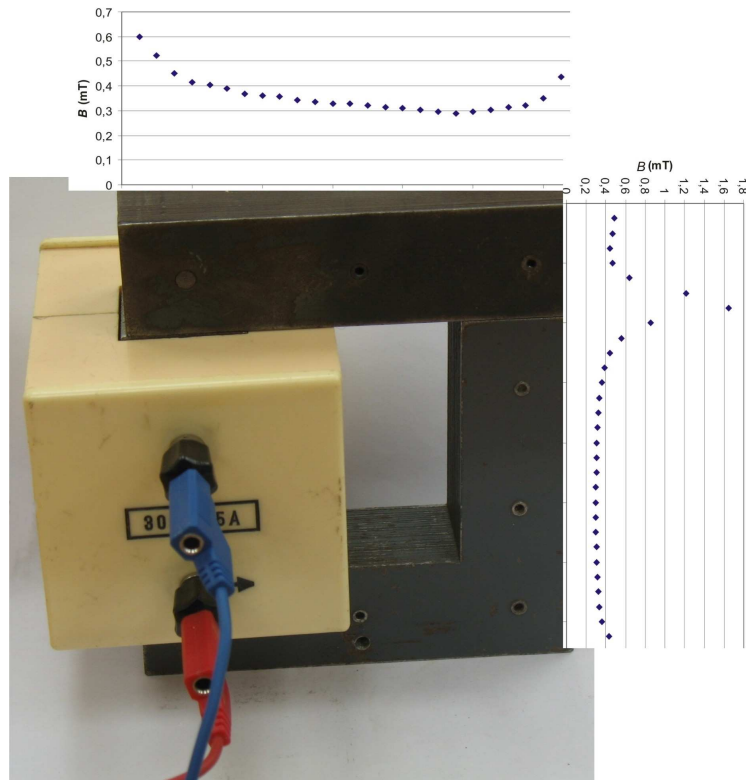


Fig. 7: How large is the dissipation of magnetic field around the core?

### Magnetic quadrupole, dipole...and monopole?

As a motivation to this experiment we can ask two or three questions:

- 1) Is it possible to demonstrate the idea of multipole expansion in a simple way?
- 2) Is it possible to demonstrate how the field of magnetic monopole would behave?
- 3) Is it possible to do such demonstrations quantitative and to obtain sufficiently precise (or at least convincing) values of powers in the dependence on distance?

Students learn in the lectures on Classical Electrodynamics that electric or magnetic field of monopole, dipole, quadrupole etc. falls down with increasing distance  $r$  from the multipole as

$$\frac{1}{r^{k+2}}, \quad (4)$$

where  $k = 0, 1, 2, \dots$  ( $k = 0$  for monopole,  $k = 1$  for dipole,  $k = 3$  for quadrupole, etc. Of course, students learn that there are no magnetic monopoles.). This knowledge follows from a theoretical derivation. Can we support the theory by some simple measurement?

As a magnetic quadrupole we can use two pairs of small thin neodymium magnets (1 cm in diameter and 2 mm in height). Members of each pair are at both sides of a paper sheet, the pairs are beside each other (see fig. 8a). The pairs of magnets have an opposite orientation. As a magnetic dipole we can use just two small magnets with a paper sheet between them (see fig. 8b). Magnets attracts together. These magnets have the same parameters as the magnets we used for the quadrupole.

We can even create the configuration which produces magnetic field that behaves (to some distance) like a magnetic monopole! As such a magnetic “monopole” we can use a small steel ball with attached rod composed of long thin neodymium magnets (see fig. 8c). In our case the magnetic rod consisted of 10 magnets 2.5 cm long and about 0.5 cm in diameter.



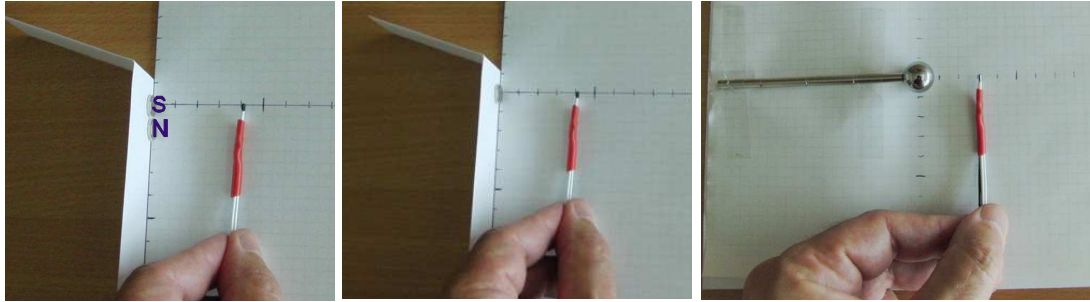


Fig. 8: a) magnetic quadrupole, b) magnetic dipole, c) magnetic “monopole”

We used a small Hall’s probe to measure field around these multipoles. The field around the “monopole” and the dipole was measured at distances from 20 mm to 100 mm, the field around the quadrupole was possible to measure only at distances between 30 mm and 60 mm. (The field near the quadrupole at distances less than 30 mm did not correspond to theoretical values for point-like quadrupole. This is natural because the distances in this case are the size of the magnets. Due to the fact that a magnetic field around the quadrupole falls down as a  $r^{-4}$  the magnetic field at distances longer than 60 mm is too small to be possible to measure it by our simple probe.)

Results of measurements can be seen in the graph in figure 9. The interpolations done by Excel show that a magnetic field we measured falls down like  $r^{-3,96}$  for the quadrupole, like  $r^{-2,94}$  for the dipole and like  $r^{-2,03}$  for “monopole”, in surprisingly well agreement with theory, (To take into account the final size of magnets could improve the agreement but even without such corrections the results seem to be sufficiently convincing – so we prefer to let the experiment and the processing of measured data as simple as they are in their current form described above.)

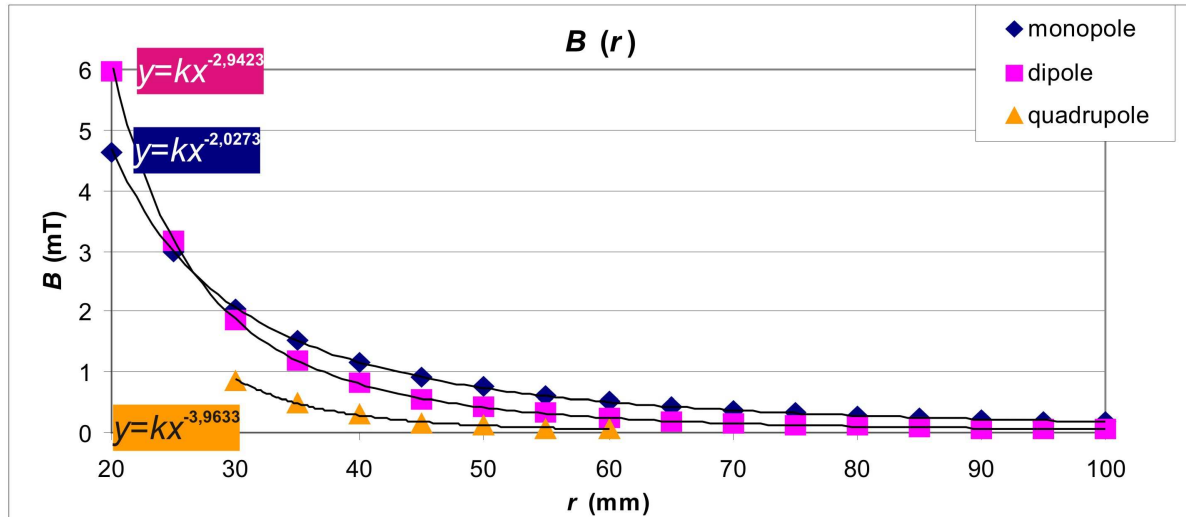


Fig. 9: Results of measurements of magnetic field near a quadrupole, dipole and a “monopole”

## Conclusions

We developed simple, low-cost and not time consuming but still quantitative demonstrational experiments that can enrich formerly only theoretical lecture on Classical Electrodynamics. Especially some non-traditional experiments may enhance motivation of students and – not only for future physics teachers – elucidate connections between theoretical formulas and reality. We plan to describe some of these experiments in more details elsewhere – and to



continue in the development of similar simple experiments that can help in students' understanding of physical theory and its relation to reality.

The work described in this article was supported by the grant FRVŠ 1237/2010/G6 of Czech Ministry of Education, Youth and Sports.

### **References**

[1] Jackson, J. D.: Classical Electrodynamics, 3<sup>rd</sup> ed.1998.

## Computer simulations enhance qualitative meaning of the Newton's second law

<sup>1</sup>Silvana Mico [smico@univlora.edu.al](mailto:smico@univlora.edu.al)

<sup>1</sup>Jorgo Mandili, <sup>1</sup> [jmandili@univlora.edu.al](mailto:jmandili@univlora.edu.al)

Valbona Tahiri, [vtahiri@univlora.edu.al](mailto:vtahiri@univlora.edu.al)

<sup>2</sup>Rezart Muco [rmuco@univlora.edu.al](mailto:rmuco@univlora.edu.al)

<sup>1</sup>Department of Physics, University of Vlora, Albania

<sup>2</sup>Department of Computer Science and Electrical Engineering, University of Vlora, Albania

### Abstract

Newton's second law of motion is the most important and useful equation in mechanics. This law gives the relationship between force and motion. Researchers have increasingly showed that students don't have a clear idea of Newton's second law. To many students the force is cause of motion. Their "misconceptions" produced by the common sense evidence are highly resistant to change. It is important for students to know what the connection between force and motion is. The Newton's second law in many textbooks for undergraduate level is treated so abstractly and students can't reach a Newtonian view of the connection between force and motion. If the study of all kind of motions is done over the second law and not in separate parts, student's conceptual understanding of mechanics will be increased.

The main task of mechanics is the study of the motion's state of the mechanic system through determination of coordinate versus time. The solution of this task is determined when is known initial state of motion of the particle and when is recognized the specific character of the forces as function of coordinates of the particle. Setting force and initial conditions for the position of the particle in differential equation of Newton's second law and solving this equation we are able to describe how the state changes in time.

Computing and communication technology continue to make an increasing impact on all aspects of education. Easy Java Simulations are powerful didactical resources that give us possibility to focus our student's attention on the physics principles. Using Easy Java Simulations we can

create our simulations through which will be studied the motion of a particle under the action of a specific force. In this paper we present the effectiveness when are combined web-based computer simulations and lectures in understanding of logical and conceptual aspects of the Newton's Second Law of Motion.

**Keywords:** Newton's second law, motion, force, change of the state, conceptual understanding, simulations, computational modeling.

## INTRODUCTION

The major goal of physics education researchers is to identify the student difficulties in learning of conceptual basis of physics. Many students have difficulties in conceptual understanding of physics. They like to see the physics as a collection of equations and think that their task is to concentrate on calculation procedures. Researchers have shown that often is ignored the direct experiences and discussion of physics concepts which can be used in different situations [8]. To avoid this tendency of students, are required rational forms of knowledge transmission, which will allow organizing it within a reasonable volume while maintaining the deep of arguments and harmonization of all knowledge in different areas of physics. There are many ways to reform the process of learning, but all require changing of the conception of learning by integrating thinking and doing.

“Science courses rarely reflect the practice of science. In most courses, students do not “do” science. Instead they only hear lectures about already validated theories. Not only do they not have an opportunity to form their own ideas, they rarely get a chance to work in any substantial way at applying the ideas of others to the world around them.” Ronald K. Thornton.

The new generation is very flexible in using new technologies. Information technology offers the potential for a rapid and radical change, but the technology supports learning when activities that they include have clear objectives and criteria. One of the best practices that integrate the students in the use of new technologies where they themselves control learning is dynamic learning using simulations of various tasks. They are modeling tools such as Easy Java Simulations [2] which leave space the phenomenological thinking and can produce the best learning experience. Easy Java Simulations are powerful and effectiveness didactical resources that give us possibility to focus our student's attention on the understanding of fundamental concepts. According to a Chinese proverb "A picture is worth a thousand words", this fact is crucial for the learning because it provides the opportunity to manage complex information.

## A. METHODOLOGY

We have chosen the Newton's Second Law of motion because it gives life all classical mechanics having extremely wide range of applications in nature and is an interesting topic to be treated by simulations. If students fail to study classical mechanics this occurs due to the not right understood of the Laws of motion.

Firstly we present some ideas about student's conceptual difficulties on Second Law and a short theory context of the power of Newton's Second Law to describe different motions of particles depending of character of forces.

After that, we present an example of web-based Easy Java Simulations in terms of Law of motion which develop understanding of relation between force and motion. These simulations are facilitator leading students to identify forces, build free body diagram and describe the motion.

Finally we present the data from student's conceptual understanding of Newton Second Law. These data are given from student's ideas before introducing Newton's law, after traditional lectures and after students working with simulations. Here are included 50 students at University of Vlora from various backgrounds such as physics, mathematics, engineering, chemistry, etc. The students attended to the class PHY 151(Introduction to Physics 1) Fall 2009, in the first year to undergraduate level. We have evaluated the impact of simulations on understanding of logical and conceptual aspects of Newton Second Law.

## B. STUDENT'S MISCONCEPTIONS ON NEWTON'S SECOND LAW

Students are familiar with Newton's Laws probably from Middle School or High School. The most of them are able in memorizing of laws and can say each word of Newton Laws. Indeed, there is no difficulties in formulating of motion law and applying the simple equation:  $\vec{F} = m\vec{a}$ . But, they don't have a clear meaning and moreover don't believe Newton's Laws. If they know what the laws say will not have a clear understanding of them.

This is due that students have their common sense concepts about motion and in most of cases they are Aristotelian's. It took about 2000 years to move from Aristotelian concept of motion up to Galileo to believe that force is changed because of motion, for example, that a net force is required to keep an object in motion at a constant velocity. We should not be surprised to find that it is a problem for ordinary students today. Accordingly, common sense beliefs should be treated with genuine respect by instructors [7]. These common sense beliefs are difficult to change and they come from daily experience. For example, although the words position, velocity and acceleration are different they have the same meaning for the most of the students and are precisely these misconceptions that difficult the understanding of the laws of motion [10]. These misconceptions reinforced by way of Newton's laws are treated in most textbooks of high school and university undergraduate level. They leave the students with formulas:  $\vec{F} = m\vec{a}$ , but virtually no understanding of the content and meaning of the second law [9].

### C. ON NEWTON'S SECOND LAW

The state of the dynamic system is completely specified by the coordinates as functions of time. If the force on a particle is known then the Newton's second law, called law of causality, determines the acceleration of a particle and from this, the position of the particle at any time. So, in principle, the motion of particle is completely predictable. The differential equation of motion is:

$$\vec{F} = m \frac{d(\vec{v})}{dt} = m \frac{d^2\vec{r}}{dt^2} \quad (1)$$

which state that: "changes in the amount of movement (evolution of the situation) is proportional to the force applied to the particle that moves ". Differential equation (1) characterizes a process because it connects the relations of defined variable sizes required by the other. Solution of Newton's differential equation takes concrete meaning only when is known the form of  $\vec{F}$  as a function of the particle coordinates. If the character of  $\vec{F}$  is known, then the equation of motion (1) in principle allows to determine the dependence of the particle coordinates. Really, while the equation of motion determines changing the speed of the material point for each time interval  $dt$  ( $d\vec{v} = \frac{\vec{F}}{m} dt$ ), it derives the determination of the material point's position in space ( $d\vec{r} = \vec{v}dt$ ).

Here we can see that the mechanical state of the material point is given by its coordinates and speed. To obtain the general solution of differential equation of Newton, a special resolution (which corresponds to the given process), help us initial conditions: position and velocity of material point in a moment accepted as the initial time, i.e the initial state of movement of the particle (prehistory of movement) when we study it. It is understood that the initial conditions (initial state), make that the situation further movement comes fully defined. Precisely this is the fundamental task of classical mechanics based on space, time and absolute motion (the classical point of view), can be determined in this way: The study of the state of motion of dynamical system (particles, the particles system, absolutely rigid body) through determination of their coordinates as functions of time. *Solution of this task is completely defined if: (1) Are known initial conditions of mechanical system (prehistory of motion). (2) Are known concrete laws of forces as functions of particles coordinates. Equations of motion that can be taken further link their states of mechanical system between each-other, in different moments of time (history of the motion).* When the law of forces are uncertain or the force acts during a very short interval of time, this task is resolved by other general laws- Conservation laws of energy and momentum.

Achieving a Newtonian point of view of the connection between force and motion, after introducing of Second law, all kind of motions should be studied over the Second law. The following concept map illustrates this idea:

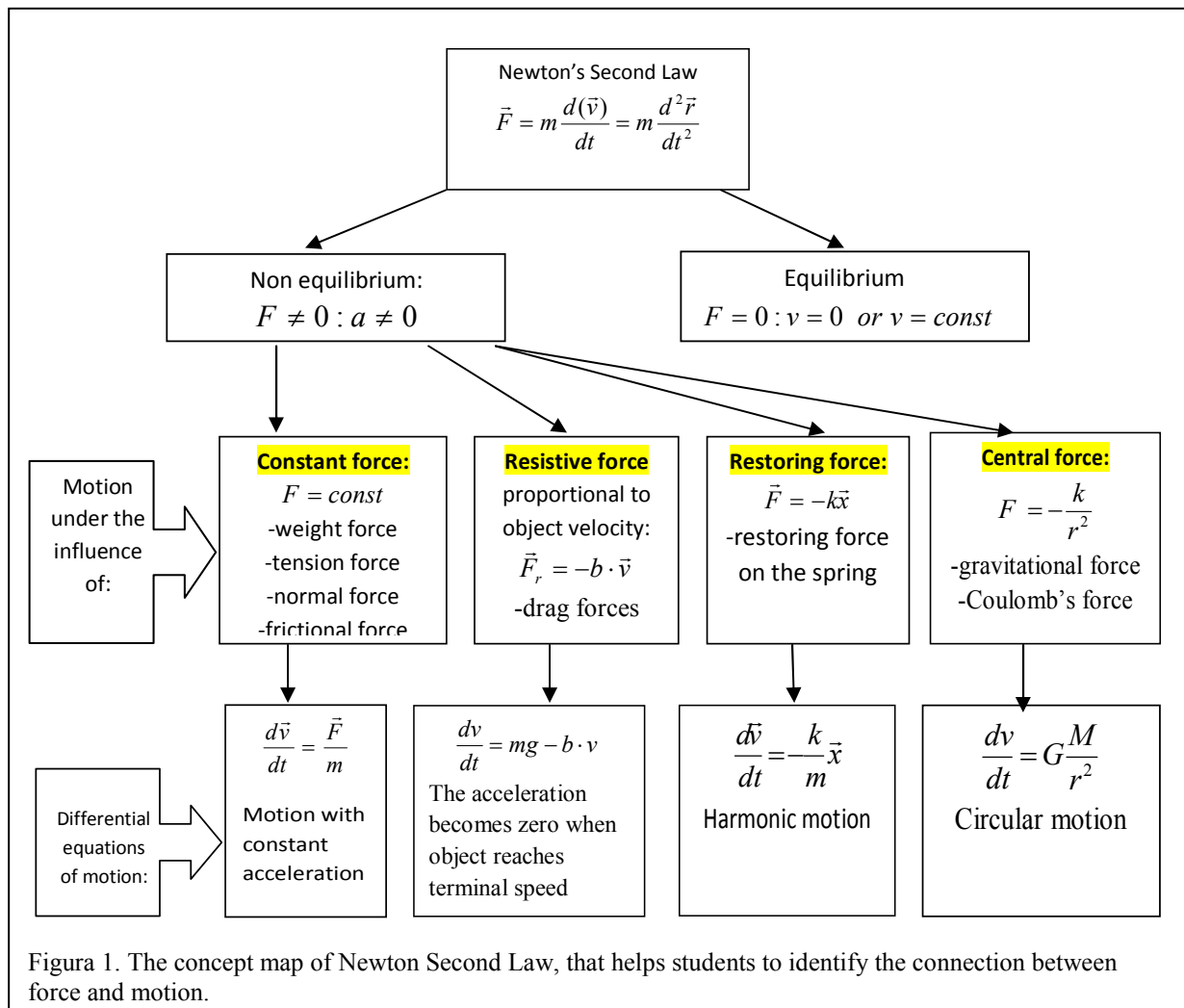


Figure 1. The concept map of Newton Second Law, that helps students to identify the connection between force and motion.

## D. SIMULATIONS

Firstly, students are asked to save on own computer simulations by browser materials from Open Source Physics(OSP) [1,3], available internet resources. Easy Java Simulations (EJS) expands the OSP tools by providing a free open-source program. Users can examine, modify, and redistribute the model with minimal effort. There are many forms to use simulations in education. But the most effective way is when students have access to the programming of the simulation [5]. With EJS materials students aren't limited to manipulating the variables into the graphics and animations of simulations. After carefully instructional support, (the most of students have difficulty to learn without continuous support) students tend to be familiar in using simulations [12].

### *Simulation: Block sliding down an incline plane*

The original example explores the role of angle of plane and frictional force in the motion of a block sliding down an incline plane. The modified simulation shows corresponding of the graphs of the position, velocity and acceleration versus time. A screen shot for this modified simulation is given in figure 2.

The students can observe forces on the block sliding down simultaneously with the graphical presentation of motion. Initially the component of gravity along the plane,  $F_t$ , is compensated by static friction force,  $F_{sf}$ , and the block stay at rest. But, static friction force can't exceed the limit value  $\mu \cdot N$ . When the slope of plane is increased by dragging up the double arrow at the plane top,  $F_t$  force is increased and is being larger then this limit and the block sliding down. Then the static friction force is replaced by a smaller force, force of dynamic friction  $F_{df}$  and so the net force is being non-zero. This simulation leads the students to the logical and

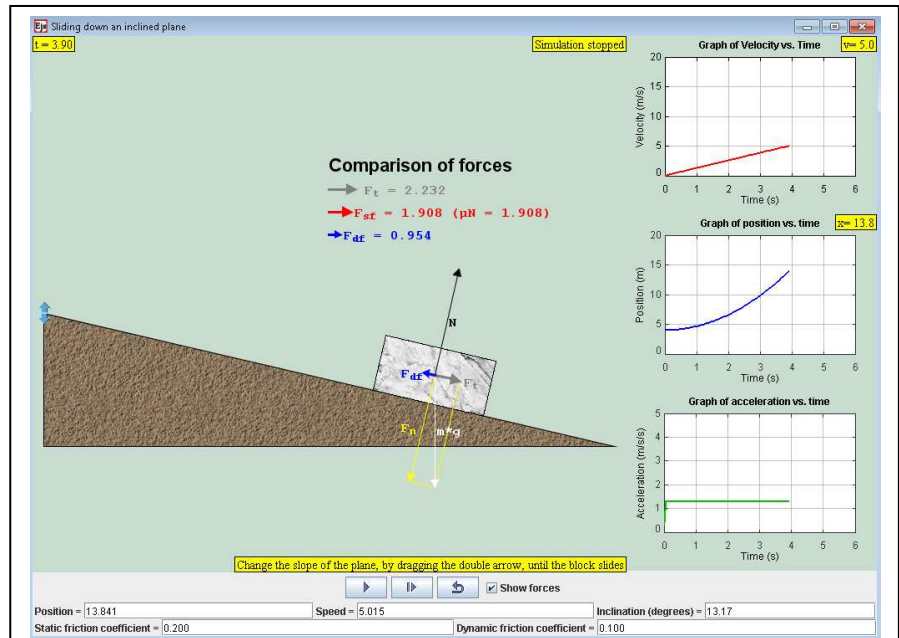


Figure 2. A screen shot of a simulation that represents a block sliding down inclined plane and graphical presentation of motion.

conceptual meaning of the statement: the motion does not need a cause but the change of motion need a cause.

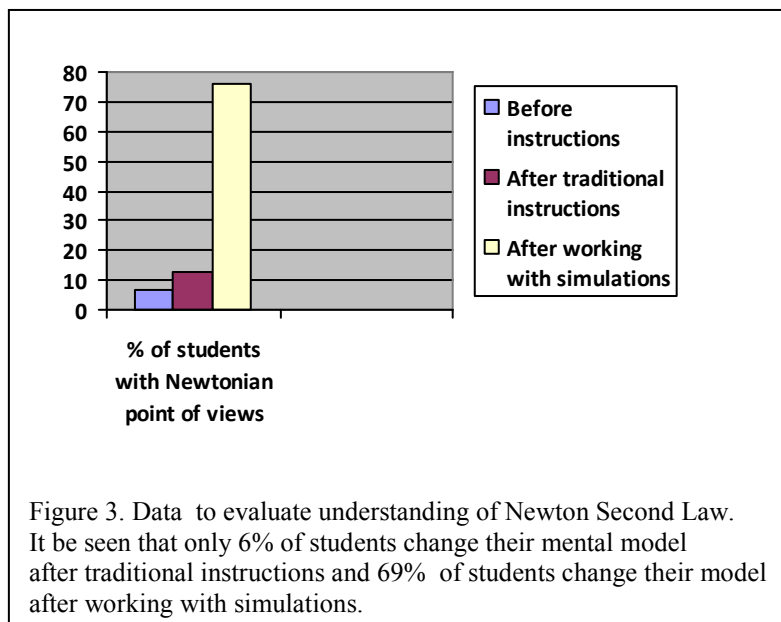
Integrating differential equation of Newton for motion of the block under constant net force can derive equations of motion:

$$F = m \frac{d^2 x}{dt^2} \rightarrow \begin{cases} x = x_0 + v_0 t + \frac{F}{2m} t^2 \\ v = v_0 + \frac{F}{m} t \\ a = \frac{F}{m} \end{cases}$$

So, if initial variables, net force and object mass are known, parameters of state-position, velocity and acceleration-are determined at any given instant of time. Students can explore the motion of the block along the incline, with different initial variables changing slope of the plane and coefficient of static and dynamic friction. Although initial position and velocity can change the form of graphs don't change. This is always a motion with constant acceleration, under a constant net force. Working with similar examples of simulations, explores the motion under a specific force (constant force, restoring force, resistive force or central force) helping students to correct mental model about Newton's Laws and other physics phenomena [10,11,13].

### E. EVALUATION OF STUDENT'S UNDERSTANDING OF NEWTON'S SECOND LAW

As an example on understanding of force and motion concepts, students are asked in class-group work (all they had already completed a study of kinematics in their physics classes) to this conceptual question: How the position, velocity and acceleration change versus time when the block sliding down inclined plane? What's the connection between motion and forces acting on the block?





Students have written their predictions and have discussed with each-other. For many students all quantities- position, velocity, acceleration and force- increased linearly respect time. In their replies forces have nothing to do with change of the speed; the force (only gravity force) needed to keep the block moving. The most of students replie: the block is free to go down, gravity gives its an initial velocity and it accelerates because the slope of the plane. Students believe that a constant force is required to keep an object in motion at a constant velocity and when the velocity is increased the acceleration must increase and the force also must increase. The motion of the block sliding down inclined plane is not motion with constant force and that's why the velocity increased. Only 7% of the student's opinions before instructions were from a Newtonian point of view. After traditional instructions only 13% of students give an exact answer. After working with simulations 76% of students have a force and motion conceptual understanding according to Newtonian point of view.

## F. CONCLUSIONS

Understanding Newton's second law is the key of understanding mechanics. Before the introduction of Newton's Second Law the students should know what we mean by the term motion, force and mass. Rushing to solving problems due their ability to manipulate only the equations of motion, not results in Newtonian conceptual understanding. It is essential to give the law of motion a context, showing how this law is to be used. Our instruction should concentrates in interpretations how second law determines motion of a particle under a specific force and development of individual experience such as simulations. The students learn better when they faced with two sources of information, one source from authority (instructors and books) and the other from direct experience.

Using EJS is an effectiveness educational practice that supports constructing of conceptual understanding of Newton Second Law of motion. The possibility to change variables and exploring in the same time forces and graphs of motion provides students in a very short time with ability to correct their own mental model and develop a clear sense of the relations between force and motion.

## REFERENCES

- [1]. *The Open Source Physics (OSP)* <http://www.compadre.org/osp>.
- [2]. Wolfgang Christian & Mario Beloni, Benjamin Cummings, *Physlet Physics Interactive Illustrations, Explorations and problems for Introductory Physics*, August, 2003.
- [3]. Esquembre F (2009) <http://www.um.es/fem/EjsWiki/Main/Documentation>, accessed 1/27/2010.
- [4]. R. K. Thornton and D. R. Sokoloff, *Assessing student learning of Newton's laws: The force and motion conceptual evaluation*, Am. J. Phys. **66**(4), 228–351, 1998.
- [5]. Wolfgang Christian, Francisco Esquembre, Bruce Mason, *Easy java simulations and the ComPADRE OSP collection*, 2009 MPTL 14, Udine Italy.
- [6]. Steve Stonebraker, Dedra Demaree, and Lei Bao, *Using an interactive simulation to teach centripetal force*, AAPT 129th National Meeting, August 2004.

- [7]. Ibrahim Abou Hallouna and David Hestenes, *Common sense concepts about motion*, Am. J. Phys. **53** (11), November 1985.
- [8]. E. F. Redish, *Teaching Physics with the Physics Suite*, (Wiley, 2003).
- [9]. A. B. Arons, *Teaching Introductory Physics*, (Wiley, 1997).
- [10]. McDermott et al (1987) Rosenquist Mark L., van Zee, Emily H, Student difficulties in connecting graphs and physics: Examples from kinematics, American Journal of Physics, Volume **55**, Issue 6, pp. 503-513,1987.
- [11] Gokhale, A., *Effectiveness of computer simulation for enhancing higher order thinking*. Journal of Industrial Teacher Education **33**, 36-46 (1996).
- [12] Wieman, C. E., Perkins, K. K. and Adams, W. K., *Oersted Medal Lecture 2007: Interactive simulations for teaching physics: What works, what doesn't and why*. American Journal of Physics **76**, 393-399 (2007).
- [13] Keller, C. J., Finkelstein, N. D., Perkins, K. K. and Pollock, S. J., *Assessing the effectiveness of computer simulation in introductory undergraduate environments*, Physics Education Research Conference Proceedings **883**,121 (2006).

## **Electronic Database of Solved Tasks in Physics**

Zdeňka Koupilová, Dana Mandíková, Marie Snětinová

Department of Physics Education, Faculty of Mathematics and Physics, Charles University in Prague

e-mails: zdenka.koupilova@mff.cuni.cz, dana.mandikova@mff.cuni.cz, snetinova.m@gmail.com

### **1 Introduction**

Within the frame of physics education at all school levels, students should reach ability to solve quantitative physics tasks correctly. Students at our faculty practice this ability during specially designed seminars accompanying each physics course. This competency is developed not only in schools during lessons and seminars but also by home study. Lots of collections of problems in physics (books as well as web based collections) exist in Czech language, for example [1, 2]. But most of these collections contain mainly unsolved tasks.

It is obvious that common (unsolved) collections of problems are not very suitable for home study. Students with insufficient previous education or mathematical skills are usually incapable of solving the task without a help of the teacher. It seems ideal that all tasks in collection are fully solved, such as in [3]. But on the other hand, reading solved problems is an ineffective way how to learn to solve physics problems as well. Problems with full solution, which is placed right under the assignment, invite students to read the solution immediately and do not induce students to solve the problems independently.

For this reason the Department of Physics Education, Faculty of Mathematics and Physics, Charles University in Prague, has been developing an electronic database of fully solved problems in physics [4] over the last five years. Albeit this collection contains fully solved problems, the collection exists only in electronic version and so it is possible to use interactive components and links to hide complete solution of tasks. Structure of the problems' solutions is specially designed to substitute tutor's help during lessons and encourage students to solve at least some parts of the problems independently. That's why there are various hints, notes with laws and formulas, plots and other means supporting students' will to solve the problem independently before reading the detailed solution.

### **2 How the collection looks like**

The page with task is divided into several parts (see Figure 1). On the left side there is drop-down menu with tasks list. Tasks in particular themes are structured into chapters and subchapters in accordance with topics of the problems. The task itself is displayed on the right side of the web page.

Tasks are classified according to difficulty into several categories – Secondary school level, Upper secondary school level, High school level and University level. Level of the task is indicated by an icon in the right upper corner. If the task is solved with some less usual method, it is included in one of the special categories: Qualitative task, Graphical task, Task with unusual solution, Complex task and Task with theory.

The compulsory sections of the tasks are title, assignment, at least one section of solution and answer. Under the assignment of the task there are placed ribbons with single section of the solution. The order of sections in the problem is not set and depends on the author. The recommended sections are hints, analysis, comments and links to similar tasks. Particular sections are described below. Each section can have its own unique title instead of general ones. There can be more than one section of same type in a problem. In addition, section ribbon can be hidden inside previous section. Using this variety in problem design, the author leads a reader through the problem in a way optimized to the type of the particular problem.

The author can also arrange the problem's sections to move readers to active thinking about the problem.

**Collection of Solved Problems in Physics**

**Mechanics**

Mechanics

Electricity and magnetism

**About**

---

**Tasks**

- Kinematics of mass point (4)
  - Passing of a Train I (L1)
  - **Passing of a Train II (L1)**
  - An ant on a rod (L4)
  - A ladybug crawling on a rotating cylinder (L4)
- Dynamics of mass point (9)
- Momentum, work, energy and power (7)
- Mechanics of rigid body (0)
- Mechanics of continuum (0)
- Gravity (0)

**Task filtering**

---

**Show task**

code:

L1

### Passing of a Train II

A passenger train of length  $L_1 = 60$  m travels at speed of  $v_1 = 80 \frac{\text{km}}{\text{h}}$ . How long does it take this train to pass a freight train of length  $L_2 = 120$  m traveling at a speed of  $v_2 = 30 \frac{\text{km}}{\text{h}}$ ?

Assume the trains travel:

a) in the same direction.

b) in opposite directions.

**Hint 1:**

**Hint 2:**

Draw a picture for both cases.

Imagine that you are the engine driver of the freight train. What is the velocity of the passenger train relative to you in both cases?

**► Solution of Hint 2:**

a) **The trains travel in the same direction.**

We can imagine that from the view of the engine driver of the freight train his train is standing still and the passenger train travels along at the speed of

$$v_a = v_1 - v_2 = 13,9 \frac{\text{m}}{\text{s}}.$$

Figure 1: Example of problem display in the collection

### Title

There is a unique title for each of the problems concisely describing the problem.

### Assignment

The assignment of the problem should be clearly formulated. We are trying to set the entry physical values to be realistic. The very important part of the problem is a picture related to the problem and motivating to solve the problem.

### Hints

The hints are written in a way to help and motivate users to solve the problem. By including the hints we're trying to involve users in solving the problem actively.

### **Analysis**

The analysis contains the whole strategy of the solution. By the analysis we're trying to introduce the physical principle of the problem to the students. The very important thing is that the analysis doesn't contain any of the mathematical formulas, which, as we hope, will prevent students from mechanically using the mathematical formulas to solve similar problems.

### **Parts of solution**

Each problem contains a commented solution part, which describes the solution step by step to the details. We're trying to include every logical operation and to describe every partial result to the details, so even a user with mathematical skills below average could understand all of the steps leading to the result. The solutions include brief resume of known data, conversions to appropriate units and numerical calculations.

### **Answer**

This section is usually containing the answer or the numeric result of the problem. It allows the users to check results very fast (i.e. when the users are solving the problem by themselves).

## **3 Current status of the collection**

Nowadays the Czech version of the database contains almost 400 physics problems divided into chapters Electricity and magnetism (about 180 tasks), Mechanics (100 tasks) and Thermodynamics (100 tasks). Other problems from these chapters are prepared to be published. In addition, chapters called Theoretical mechanics and Quantum Mechanics are prepared and 40 problems from quantum mechanics are ready for inclusion. Most of the tasks are created as a part of bachelor and diploma theses on the Department of Physics Education, Faculty of mathematic and Physics, Charles University in Prague.

The collection has in the present the international (English and Polish) version too and is prepared for extension to other languages. The international version is placed at: <http://physicstasks.eu/> [5]. It contains sample of 32 problems translated into English and sample of 30 problems translated into Polish. Many other problems are being translated.

## **4 Experience with usage of the collection**

The collection of problems is used in high schools and universities during lessons and seminars aimed at problem solving in mechanics, electricity and magnetism and thermodynamics. To help monitor the usability of the collection, users could fill in the feedback questionnaire. Completion of the questionnaire is voluntary. Up to the date of October 7, 73 questionnaires have been completed and processed.

Research of usability was based primarily on information gathered from students of Faculty of Mathematics and Physics of Charles University in Prague. About 19 % of respondents who filled in the feedback questionnaire used the collection of problems regularly during the term. Users appreciate the structure of the tasks (especially hints and analysis) and the database interface.

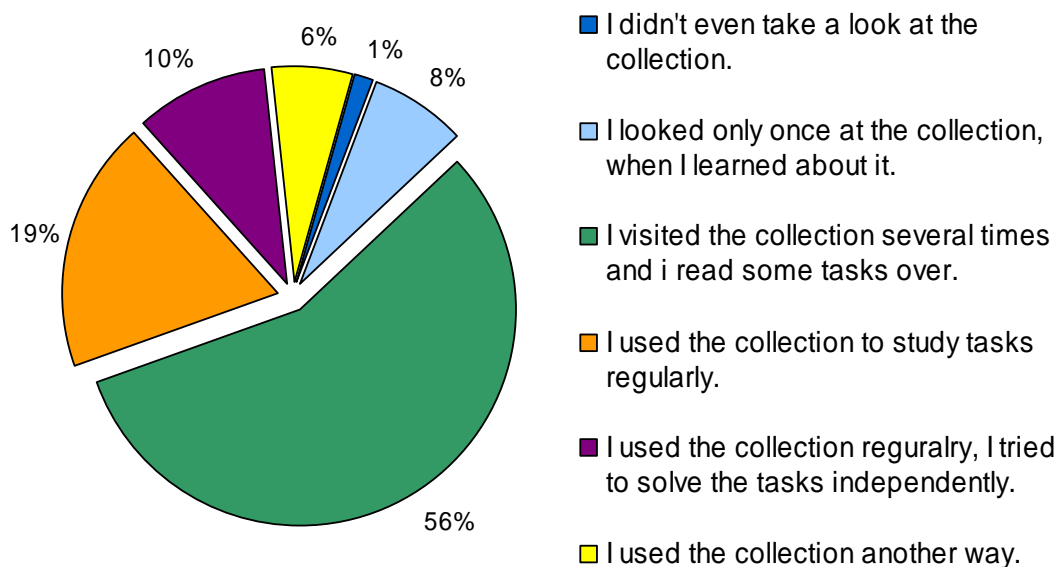


Figure 2: The diagram shows how readers used the collection.

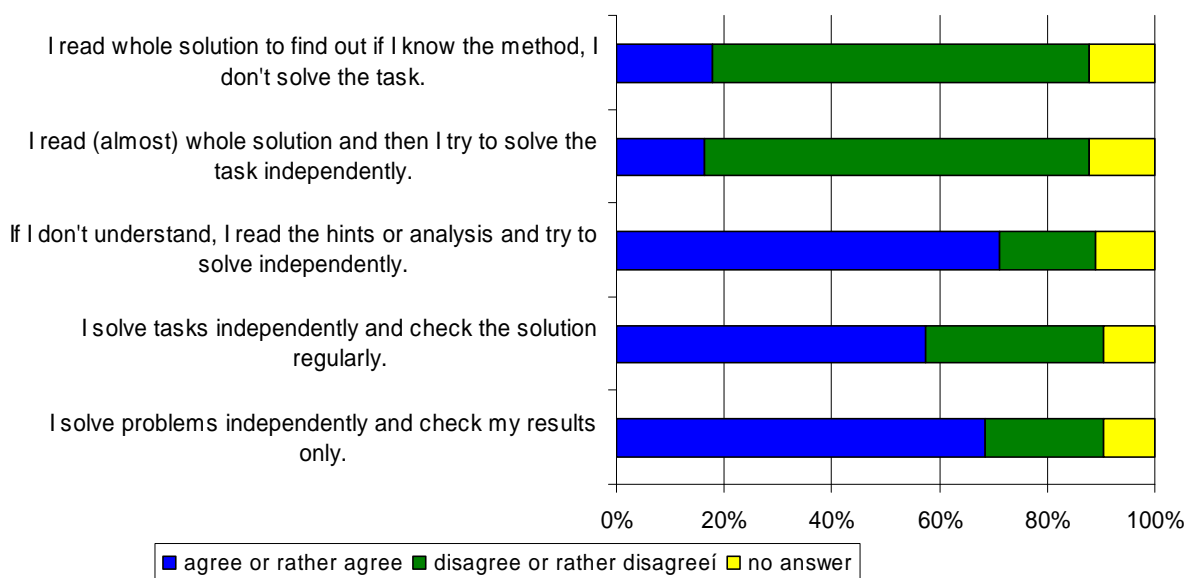


Figure 3: The diagram shows which method readers use for problem solving.

## 5 Experiments inspired by tasks

The development of problems from electromagnetism is a part of Czech-Polish cooperation. Within this project, Polish colleagues were inspired by the electronic collection and in addition to translation of the tasks into Polish, they created several physics experiments based on tasks from the collection. These experiments were also presented on the GIREP conference (Rochowicz; Electromagnetism – seeing and calculating). Instructions to the experiments will be translated into Czech and will be added into the collection.

## 6 Future plans

Besides the development of new tasks in mechanics, electromagnetism and thermodynamics we would like to add problems from theoretical and quantum mechanics to the database as well as to connect problems with the study text by the means of interactive links next year. The chosen tasks will be translated continuously into English and Polish. We would like to continue with the monitoring of the usability of the collection. Users' feedback will enable us to improve the database interface in the future.

## 7 Conclusion

The database is placed at the website of the Department of Physics Education, Faculty of Mathematics and Physics, Charles University in Prague, the link to the Czech version is <http://www.fyzikalniulohy.cz/>. The international (English and Polish) version is placed at: <http://physicstasks.eu/>. The database is available for students of our faculty as well as for general public.

Teachers and students find the collection as a very useful material. On that account we would like to broaden and improve the electronic collection in the future. We believe that it will become a good assistant for all students and physics teachers. If you are interested, have some idea or remark to the collection or want to join, please contact us at the address:

*sbirka@kdf.mff.cuni.cz.*

*The creation of the tasks from electromagnetism and molecular physics and thermodynamics was support within the scope of solving projects FRVŠ F6 759/2008 and FRVŠ F6 788/2010.*

*The development of the Polish interface was part of the international project supported by International Visegrad Fund (project number 20910347).*

*The translation of the tasks into English was done within the scope of the sub-project of the development project of Ministry of Education in the Czech Republic (project number 14/38/2010).*

## References

- [1] Lepil Oldřich, Bednařík Milan, Šíroká Miroslava. Fyzika. Sbíрка úloh pro střední školy. 3. vyd. Praha: Prometheus, 2007. (only in Czech)
- [2] Kružík Miroslav. Sbíрка úloh z fyziky pro žáky středních škol. 8. vyd. Praha: SPN, 1984. (only in Czech)
- [3] Bartuška Karel. Sbíрка řešených úloh z fyziky pro střední školy I. – IV. Praha: Prometheus, 1997 – 2000 (set of four books). (only in Czech)
- [4] Electronic collection of solved problems in physics (Czech version) [online] [cit. 12.10. 2010]: <http://www.fyzikalniulohy.cz/>
- [5] Electronic collection of solved problems in physics (English version) [online] [cit. 12.10. 2010]: <http://www.physicstasks.eu/>